



TECHNICAL GUIDE

SINGLE PACKAGE

AIR CONDITIONER / GAS HEAT

16 SEER – R-410A – 460V - 3 PHASE

3 THRU 5 NOMINAL TONS

65 - 125 MBH HEAT INPUT

MODELS: PCG6*36 THRU 60



Due to continuous product improvement, specifications are subject to change without notice.

Visit us on the web at www.upgnet.com and www.york.com

Additional rating information can be found at: www.ahridirectory.org

WARRANTY SUMMARY*

Standard 1-Year limited parts warranty.

Standard 5-Years limited compressor warranty.

10-Year gas heat exchanger warranty.

*See limited warranty certificate in User's Information Manual for details

DESCRIPTION

These packaged cooling/heating air conditioners are designed for outdoor installation. Only utility and duct connections are required at the point of installation.

FEATURES

- **Operating Efficiency** - All PCG6 model gas units provide a minimum AFUE of 81.0% in heating and 16.0 SEER, 12.0 EER rating for cooling operation. All models meet California Low-Nox requirements of 40 ng/joule emission level for Air Quality Management Districts. All PCG6 models utilize a multi-stage compressor for maximum comfort and efficiency.
- **On Site Flexibility** - All model sizes use a compact design cabinet. Field convertible duct connections from side flow to downflow allows the installer to have greater flexibility with less inventory.
- **Lower Installation Cost** - Installation time and costs are reduced by easy power and control wiring connections. The small base dimension means less space is required on the ground or roof. All units are completely wired, charged with R-410A and tested prior to shipment. Test stations using a state-of-the-art computerized process system are used to ensure product quality. Refrigerant charge and component part numbers are verified via computers during assembly. Vital run test statistics such as system pressure, motor currents, air velocity and temperature, unit vibration, and gas system safeties are monitored and recorded by the system to ensure unit performance. Equal size side supply and return duct connections allow easy connection of ducts to match low crawl spaces without transition pieces.
- **Utility Connections Made Easy** - Gas and electric utility access provided through the bottom or the side of the unit. Utility connections can be made quickly and with a minimum amount of field labor. A field supplied and field installed electrical disconnect switch must be installed.
- **Convertible Airflow Design** - The bottom duct openings are covered when they leave the factory, ready to be used for a side supply/side return application. If a bottom supply/bottom return application is desired, simply remove the two panels from the bottom of the unit and place them in the side supply/side return duct openings. No panel cutting is required and no accessory panel is necessary. Convertible airflow design allows maximum field flexibility and minimum inventory.
- **Condensate Pan** - A corrosion-resistant, long-lasting, water-tight pan is positioned below the evaporator coil to collect and drain all condensate, preventing build-up of stagnant condensate. The condensate pan conforms to ASHRAE 62-89 standards (Ventilation for Acceptable Indoor Air Quality).
- **Condensate Drain** - The 3/4 inch NPT female connection is rigidly mounted to assure proper fit and leak tight seal.
- **Durable Finish** - The cabinet is made of G90 galvanized steel with a powder paint coating for appearance and protection. The pre-treated galvanized steel provides a better paint-to-steel bond, which resists corrosion and rust creep. Powder paint finish ensure less fading when exposed to sunlight, and provides superior corrosion resistance (1000 hour salt spray tested).

Continued on next page.

- **Full Perimeter Base Rails** - The easily removable base rails provide a solid foundation for the entire unit and protects the unit during shipment. The rails provide fork lift access from all sides, and rigging holes are also provided so that an overhead crane can be used to place the units on a roof. On applications where the unit is placed on a pad, the base will keep the unit off the pad to deter corrosion. On applications where height is limited, the base rails may be removed by removing 2 screws in each corner.
- **More Attractive Appearance** - A single-piece top cover containing a top-discharge outdoor fan arrangement requires less square footage on installation and provides a wider variety of installations. The one-piece design adds greater water integrity. Rounded corners with water drip edges add to the attractive appearance.
- **Top Discharge** - The top-discharge outdoor fan does not disrupt neighboring areas or dry out vegetation surrounding the unit. The warm air from the top mounted fan is blown up and away from the structure and any landscaping. This allows compact location on multi-unit applications.
- **Outdoor Coil Grille** - All models utilize a stamped slotted design which provides superior impact protection against small objects during transit and after installation.
- **Low Operating Sound Level** - The upward air flow carries the normal operating noise up and away from the living area. The rigid top panel effectively isolates noise. Isolator mounted compressor and the rippled fins of the outdoor coil muffle the normal fan motor and compressor operating sounds. The uniquely formed base pan also aids in sound attenuation with its structural design. This design strategically places embossments in the pan for optimum strength and rigidity.
- **Fan System** - All models operate over a wide range of design conditions with an enhanced ECM indoor fan motor. These units easily match all types of applications and provide greater on-site flexibility to match comfort requirements. The cooling speed is factory-set and can be field-adjusted to a second speed. The heating speed is factory set to maintain mid point rise at the units heating input, but can be field adjusted. This allows maximum comfort conditions.
- **Simple Control Circuit** - A low voltage gas heat printed circuit board contains a status/diagnostic indicator light. Field thermostat wiring connects to color coded leads using twist on wire connections. Cooling controls use contactor and relays for simple application and troubleshooting. Mate-n-lock plug connectors are used. The electrical control box is not located in the compressor compartment. The controls are mounted to allow the separate access panel to be removed for trouble shooting and maintenance without affecting the normal system operating pressures. All wiring internal to the unit is color/number coded.
- **Protected Compressor** - The compressor is internally protected against high pressure and temperature. This is accomplished by the simultaneous operation of scroll bypass and a temperature sensor which protect the compressor if undesirable operating conditions occur.
- **Pressure Switches** - A high pressure switch is standard in all units. It is an automatic reset switch. When discharge pressure reaches 650 psi, the compressor de-energizes until pressure reaches 450 psi.
- **Exclusive Coil Design** - Grooved copper tubes and enhanced aluminum fin construction improves heat transfer for maximum efficiency and durability for long-lasting durability and efficient operation. Indoor coils use tin-coated copper tubing with aluminum fins for effective heat transfer.
- **Heat Exchangers** - Gas heat exchangers use corrosion-resistant, stainless-steel tubular construction to provide long-life, trouble-free operation. Gas heat exchangers are offered with lifetime warranties as standard with registration.
- **Post Purge Induced Draft Combustion** - Exhausts combustion products from the heat exchanger upon completion of the heating cycle to prolong the heat exchanger life.
- **Spark To Burner Ignition** - No pilot assembly required, which provides more consistent ignition in gas heating mode. This ignition is highly reliable, durable and eliminates nuisance lockouts.
- **Multi Port In-shot Burners** - No field adjustment is required to mix the air and gas for natural gas or propane use. These burners are constructed of high-grade corrosion-resistant, aluminized steel.
- **Low Maintenance** - Long life, permanently lubricated outdoor and evaporator fan motor bearings need no annual maintenance, adding greater reliability to the unit. Slide-out blower assembly can be easily removed for cleaning.
- **Easy Service Access** - Individual access panels covering the electrical and gas controls makes servicing easy. Removing this panel will allow easy removal of the blower assembly for maintenance and ease of troubleshooting.
- **Replacement Parts** - The installer requires no special training to replace any of the components of these units and the number of new components have been reduced to minimize the inventory of unique parts.
- **Loss of Charge Switch** - All models include a loss of charge switch to provide safe shutdown of compressor.
- **Filter Frame Kit** - All 3 phase units include a filter frame kit which is shipped inside the unit from production. Field installation is required.
- **Filters** - All 3 phase units include an applicable number of 1" washable filters, which are shipped inside the unit from production. Field installation is required. Three filters are required for the B base units.

NOMENCLATURE

PCG	4	A	24	50	2	X	1	A
1	2	3	4	5	6	7	8	9
1. Model Family PCG - packaged A/C with gas heat, PHG - packaged heat pump with gas heat, PCE - packaged A/C with electric heat, PHE - packaged heat pump with electric heat 2. Nominal Cooling Efficiency 4 = 14 SEER, 6 = 16 SEER, etc. 3. Cabinet Size A = small 35 x 51, B = large 45 x 51 4. Nominal Air Conditioning Cooling Capacity BTUx1000 24 = 24,000 BTU, etc. Examples: PHG4B421002X1A is a dual fuel, 14 SEER, 3-1/2 ton, large cabinet, single-stage heat, 100,000 BTU gas heat, 230 volt, single phase, low-NOx model (first generation, first release)					5. Gas Heating Input BTU/Hr x 1000 050 = 50,000 BTU/Hr. input, blank = electric heat 6. Voltage-Phase-Frequency 2 = 208/230-1-60, 3=208/230-3-60, 4 = 460-3-60 7. NOx Approval X = low-NOx, blank = not low-NOx 8. Generation Level 1 = first generation 9. Revision Level A = original release, B = second release			

COMPONENT LOCATION

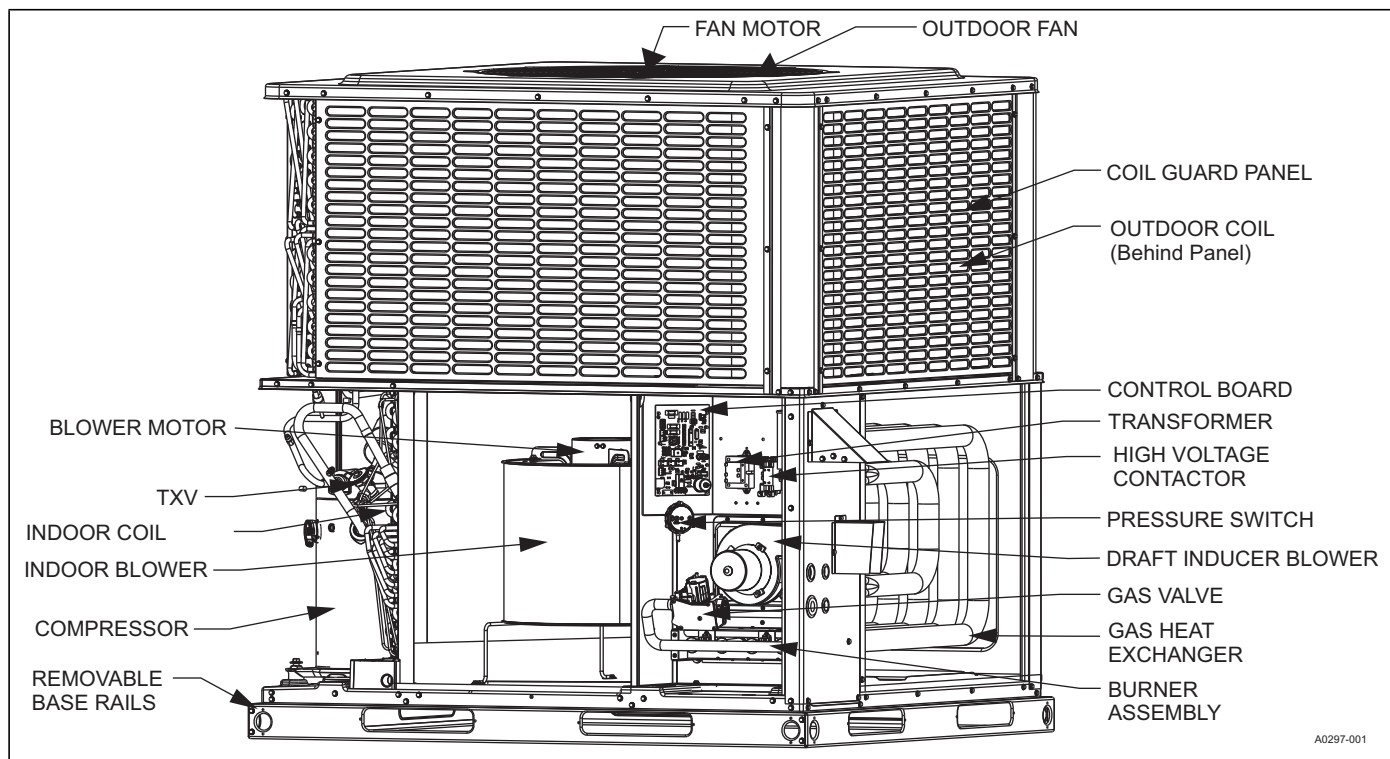

UNIT LIMITATIONS

Model	Unit Voltage	Unit Limitations		
		Applied Voltage		Outdoor DB Temp
		Min	Max	Max (°F)
All Models	460-3-60	432	504	125

ACCESSORIES

- **Propane Conversion Kit (S1-1NP0704)** - Kit includes burner orifices, gas valve conversion and installation instructions necessary to field convert unit from natural gas to propane.
- **Economizer for Downflow Applications (S1-2EE04710024, S1-2EE04710124)** - Modulating integrated economizer provides simultaneous operation between the mechanical cooling and economizer operation. Independent blade design ensures proper control and less than 1% leak rate. Includes hood and mesh bird screen filter integrated into the hood, dry bulb sensor and relief damper. Separate field accessories of single enthalpy and dual enthalpy are also available.
- **Economizer for Horizontal Applications (S1-2EE04710224, S1-2EE04710324)** - Modulating integrated economizer provides simultaneous operation between the mechanical cooling and economizer operation. Independent blade design ensures proper control and less than 1% leak rate. Includes hood and mesh bird screen filter integrated into the hood, dry bulb sensor and relief damper. Separate field accessories of single enthalpy and dual enthalpy are also available.
- **Single/Dual Enthalpy Sensor (S1-HE-6863-0N00WS)** - Sensor replaces supply air temperature dry bulb sensor standard in economizer kit. Provides improved economizer operation by sensing the dry bulb temperature of indoor supply air plus the enthalpy content of the outdoor air.
- **Duct/Unit Mount CO2 Kit (S1-2AQ04700924)** - Sensor kit detects CO2 levels automatically and overrides the economizer when CO2 levels rise above the preset limits.
- **Wall Mount CO2 Kit (S1-2AQ04701024)** - Sensor kit detects CO2 levels automatically and overrides the economizer when CO2 levels rise above the preset limits.
- **Supply Air Temperature Sensor Kit (S1-TE-63616E-2D)** - Outdoor supply air temperature sensor kit used with economizers.
- **Filter/Frame Kit (Kit provided) (S1-1FF0602, S1-1FF0601)** - Kit contains the necessary hardware to field install return air filters into the base unit. The filter rack is suitable for either 1" or 2" filters.
- **Filter (S1-02647812000)** - Washable 1" filter. Three filters are required for the B base units. Washable filters are included inside shipped units for field installation.
- **Motorized Fresh Air Damper (S1-2MD04705224, S1-2MD04705124)** - Designed for duct mounted side supply/return and unit mounted down supply/return applications. Damper capable of providing 0% through 50% of outdoor air (field supplied). Closes on power loss, includes hood and screen assembly.
- **Loss of Charge Switch (S1-2LC00024)** - Kit provides Loss of Charge Switch and wiring to provide safe shutdown of compressor.
- **Transition Curb Kits (S1-1TC01*)** - Adapter kits to allow field use of pre-existing installed roof curbs to match PCG6* footprint to Affinity roof curbs, Carrier, Trane, or Goodman curb footprints. Curb adapters are optional for current generation Carrier replacements but are recommended for previous generation applications. Refer to the PCG6* price pages for more details.
- **Rectangle to Round (Horizontal) Adapter (S1-1AK0110, S1-1AK0111)** - Kit includes one supply and one return air rectangle to round duct adapter. Adapters are preformed and designed to fit over current horizontal duct openings on the base unit. Transition is from rectangle to 12" round for the 1AK0110 kit and from rectangle to 14" round for the 1AK0111 kit.
- **Rectangle to Round (Downflow) Adapter (S1-1AK0108, S1-1AK0109)** - Kit includes one supply and one return air rectangle to round duct adapter. Adapters are preformed and designed to fit into current downflow duct openings on the roof curb. Transition is from rectangle to 16" round for the 1AK0108 kit and from rectangle to 18" round for the 1AK0109 kit.
- **Roof Curbs (S1-1RC0503, S1-1RC0501)** - NRCA approved curbs provide proper fit to base unit for rooftop installations. Curbs are designed to be assembled through hinge pins in each corner. Kit also provides seal strip to assure an air tight seal. These are 8 inch high roof curbs.
- **Roof Curbs (S1-1RC0504, S1-1RC0502)** - NRCA approved curbs provide proper fit to base unit for rooftop installations. Curbs are designed to be assembled through hinge pins in each corner. Kit also provides seal strip to assure an air tight seal. These are 14 inch high roof curbs.
- **Manual Outdoor Damper (S1-1FA0502, S1-1FA0501)** - Provides 0% through 50% outdoor air capability (field adjustable). Designed for duct mounted side supply/return applications. Includes hood and screen assembly.
- **Thermostat (S1-THXU280*)** - Compatible thermostat controls are available through accessory sourcing. For optimum performance, these outdoor units are fully compatible with the York Hx™ Touchscreen Thermostat (S1-THXU280*) available through Source1. For more information, see the thermostat section of the Product Equipment Catalog.
- **Wall Thermostat** - The units are designed to operate with standard, 24-volt electronic and electro-mechanical thermostats. All units can operate with a single stage heat thermostat, but requires a multistage thermostat for cooling.
- **Low Ambient Kit (S1-2LA04701024)** - Kit provides necessary hardware to convert unit to operate in cooling cycle down to 0° F. Standard unit operation 45° F.
- **Base Rail Hole Cover Kit (S1-1HC0101)** - Kit provides necessary hardware to close off openings in base rails to block off openings, i.e. prevent animal entrance.

GUIDE SPECIFICATIONS

GENERAL

Units shall be manufactured by Unitary Products in an ISO 9001 certified facility. Package units give you the flexibility and choices you need in today's market. These packaged cooling/heating air conditioners are designed for outdoor installation. Only utility and duct connections are required at the point of installation. The single-stage gas fired heaters have stainless steel tubular heat exchangers and spark to burner ignition. They are available in natural gas with field conversion to propane.

DESCRIPTION

Units shall be factory-assembled, single packaged, Electric Cooling/Gas Heating units, designed for outdoor installation. For SEER ratings, refer to technical literature. They shall have built in, equal size, field convertible duct connections for supply/return or horizontal supply/return. The units shall be factory wired, piped, charged with R-410A Refrigerant and factory tested prior to shipment. All unit wiring shall be both numbered and color coded. All models shall be rated in accordance with DOE and AHRI test procedures for both heating and cooling operation. Units shall be CSA listed and classified to ANSI Z21.47/CAN/ CSA 2.3 standards and UL 1995/CAN/CSA No. 236-M90 standards.

UNIT CABINET

Unit cabinet shall be constructed of G-90 galvanized, powder-painted steel, certified at 1000 hours salt spray test per ASTM-B117 standards. The unit top shall be a single piece design, with drip edges and no-seam corners to provide optimum water integrity. Unit shall have a rigidly mounted outdoor coil guard to provide protection from objects and personnel after installation. Indoor blower section shall be insulated with foil-faced or foam insulation, fastened to prevent insulation from entering the air stream. Cabinet panels shall be separate, easily removable for servicing and maintenance. Unit shall be built on a formed, design base pan, with embossments at critical points to add strength and rigidity and to aid in minimizing sound. Full perimeter base rails shall be provided to assure reliable transit of equipment, overhead rigging, for truck access and proper sealing on roof curb applications. Base rails shall be easily removable, when required to lower unit height. Filters shall be field installed, furnished and be accessible through a removable access door, sealed airtight. Units vertical discharge and return duct configuration shall be designed to fit between standard 24" O.C. beams without modification to building structure, duct work and base unit. Condensate pan shall be internally sloped and conform to ASHRAE 62-89 self-draining standards, with 3/4" NPT female ridged mount connection.

Indoor Blower Assembly - Fan shall be direct drive design. Fan wheel shall be double-inlet type with forward-curved blades, dynamically balanced to operate smoothly throughout the entire range of operation. Airflow design shall be constant air volume. Bearings shall be sealed and permanently lubricated for longer life and no maintenance. Fan assembly shall be a slide-out design for easy removal and cleaning. Indoor blower motors shall be equipped with a standard high efficiency brushless DC motor (constant torque) also known as a standard ECM motor.

Outdoor Fan Assembly - The outdoor fan shall be of the direct-driven propeller type, discharge air vertically, have aluminum blades riveted to corrosion resistant steel spider bracket and shall be statically balanced for smooth operation. The outdoor fan motor shall be totally enclosed with permanently lubricated bearings and internally protected against overload conditions.

REFRIGERANT COMPONENTS

Compressors:

- Shall be fully hermetic type, direct drive, internally protected with internal high-pressure relief and over temperature protection. The hermetic motor shall be suction gas cooled and have a voltage range of +/- 10% of the unit nameplate voltage.
- Shall have internal isolation and sound muffling to minimize vibration and noise, and be externally isolated on a dedicated, independent mounting.

Coils:

- Indoor coils shall have aluminum plate fins mechanically bonded to seamless internally enhanced tin-coated copper tubes with all joints brazed.
- Indoor coil shall be of the direct expansion, draw through design.
- Outdoor coils shall have aluminum plate fins mechanically bonded to seamless internally enhanced copper tubes with all joints brazed.
- Outdoor coil shall be draw through design.

Refrigerant Circuit and Refrigerant Safety Components shall include:

- Thermal expansion devices (TXVs) shall be factory mounted and provided.
- Filter/strainer to eliminate any foreign matter.

GAS HEATING SECTION (If Equipped)

Heat exchanger and exhaust system shall be constructed of corrosion-resistant materials and shall be designed with induced draft combustion with post purge logic and redundant main gas valve. The heat exchanger shall be of the tubular type, constructed of stainless steel for corrosion resistance and allowing minimum mixed air entering temperature of 40 °F. Burners shall be of the in-shot type, constructed of aluminized steel. All gas piping shall enter the unit cabinet at a single location through either the side or bottom, without any field modifications. An integrated control board shall provide timed control of indoor fan functioning and burner ignition.

Heating section shall be provided with the following minimum protection:

- a. Primary high-temperature limit switch.
- b. Induced draft pressure switch.
- c. Flame roll out switch(es) (manual reset).
- d. Flame proving controls.

All gas heat models will meet the California requirement for emissions of less than 40 nanograms per Joule (California requirement on single phase models only).

PHYSICAL DATA

MODEL:	PCG6B36		PCG6B42		PCG6B48			PCG6B60		
NOMINAL TONNAGE:	3.0		3.5		4.0			5.0		
COMPONENT										
AHRI Cooling Performance										
Gross Capacity @ AHRI A point (MBH)	36.5		43.3		49.1			60.0		
AHRI net capacity (MBH)	36.0		42.5		45.5			58.0		
EER	12.5		12.5		12.0			12.0		
SEER	16.0		16.0		16.0			16.0		
Nominal CFM	1200		1400		1600			2000		
System power (kW)	3.0		3.4		3.6			4.6		
Refrigerant type	R410A		R410A		R410A			R410A		
Refrigerant charge (lb-oz)	11-8		11-4		13-8			14-0		
AHRI Gas Heat Performance										
Heating model	65	100	65	100	65	100	125	65	100	125
Heat input - High Fire (kBtu)	65	100	65	100	65	100	125	65	100	125
Heat output - High Fire (kBtu)	52	81	52	81	52	81	101	52	81	101
Heat input - Low Fire (kBtu)	43	65	43	65	43	65	82	43	65	82
Heat output - Low Fire (kBtu)	34	53	34	53	34	53	66	34	53	66
AFUE%	81.0	81.0	81.0	81.0	81.0	81.0	81.0	81.0	81.0	81.0
No. burners	2	3	2	3	2	3	4	2	3	4
No. stages	2	2	2	2	2	2	2	2	2	2
Temperature Rise Range - High Fire (°F)	40-70		40-70		40-70			40-70		
Temperature Rise Range - Low Fire (°F)	25-55		25-55		25-55			25-55		
Max. Static Pressure w.c.	0.5		0.5		0.5			0.5		
Max. Outlet Air Temp. (°F)	180		180		180			180		
Gas piping connection (inch)	1/2		1/2		1/2			1/2		
Dimensions (inches)										
Length	51-1/4		51-1/4		51-1/4			51-1/4		
Width	45-3/4		45-3/4		45-3/4			45-3/4		
Height	49		49		53			55		
Compressor										
Type	Scroll		Scroll		Scroll			Scroll		
Stages	2		2		2			2		
Outdoor Coil Data										
Face area (Sq. Ft.)	19.5		19.5		23.8			25.9		
Rows	2		2		2			2		
Fins per inch	22		22		22			22		
Tube diameter	3/8		3/8		3/8			3/8		
Circuitry Type	Interlaced		Interlaced		Interlaced			Interlaced		
Indoor Coil Data										
Face area (Sq. Ft.)	6.3		6.3		6.3			6.3		
Rows	3		3		3			4		
Fins per inch	16		16		16			16		
Tube diameter	3/8		3/8		3/8			3/8		
Circuitry Type	Interlaced		Interlaced		Interlaced			Interlaced		
Refrigerant control	TXV		TXV		TXV			TXV		

Continued on next page.

PHYSICAL DATA (Continued)

MODEL:	PCG6B36	PCG6B42	PCG6B48	PCG6B60
NOMINAL TONNAGE:	3.0	3.5	4.0	5.0
COMPONENT				
Outdoor Fan Data				
Fan diameter (Inch)	26	26	26	26
Type	Prop	Prop	Prop	Prop
Drive type	Direct	Direct	Direct	Direct
No. speeds	1	1	1	1
Motor HP each	1/3	1/3	1/3	1/3
RPM	850	850	850	850
Nominal total CFM	3200	3200	3200	3200
Direct Drive Indoor Fan Data				
Fan Size (Inch)	11 x 10	11 x 10	11 x 10	11 x 10
Type	Centrifugal	Centrifugal	Centrifugal	Centrifugal
Motor HP each	1/2	1	1	1
RPM	1200 Max	1200 Max	1200 Max	1200 Max
Frame size	48	48	48	48
Filters				
Filter Size	B	B	B	B
Quantity - Size	Field-supplied external filters must be sized so as not to exceed 300 fpm air velocity through disposable filters. For internal filter use, a filter rack kit is available. Consult the instructions supplied with that kit for replacement filter sizes. Filter sizes: A=20x10 (2 each), B=20x10 (3 each).			

COOLING PERFORMANCE DATA - 3 TON (LOW SPEED) - MODEL NO. PCG6B36																			
CONDENSER ENTERING AIR TEMPERATURE	ID CFM	600						800						1000					
	IDDB	80	80	75	80	80	80	80	75	80	80	80	80	75	80	80			
	IDWB	57	62	62	67	72	57	62	62	67	72	57	62	62	67	72			
55 / 45	T.C.	34.8	41.4	41.7	46.0	49.1	37.3	41.2	41.5	44.6	47.3	39.7	41.0	41.2	43.1	45.4			
	S.C.	34.1	28.8	25.1	25.4	20.5	36.8	32.1	27.8	26.7	21.0	39.4	35.4	30.6	28.0	21.5			
	K.W.	2.35	2.20	2.19	2.16	2.13	2.30	2.16	2.16	2.13	2.11	2.25	2.13	2.13	2.11	2.09			
65 / 55	T.C.	33.2	39.0	39.2	43.6	47.3	35.4	38.8	38.8	42.6	45.7	37.6	38.5	38.4	41.7	44.2			
	S.C.	32.4	27.6	23.7	24.2	19.5	34.8	30.7	26.3	25.9	20.3	37.3	33.9	28.9	27.6	21.2			
	K.W.	2.56	2.40	2.39	2.36	2.33	2.51	2.37	2.36	2.34	2.31	2.46	2.33	2.33	2.31	2.29			
75 / 63	T.C.	31.5	36.6	36.7	41.2	45.5	33.5	36.3	36.1	40.7	44.2	35.4	36.0	35.6	40.2	42.9			
	S.C.	30.7	26.4	22.2	22.9	18.4	32.9	29.4	24.8	25.0	19.6	35.1	32.4	27.3	27.2	20.8			
	K.W.	2.77	2.61	2.59	2.57	2.52	2.71	2.57	2.56	2.54	2.50	2.66	2.53	2.54	2.51	2.48			
85 / 69	T.C.	30.2	34.7	34.1	38.9	42.3	31.6	34.0	33.4	38.3	41.2	33.0	33.3	32.7	37.8	40.0			
	S.C.	29.1	25.1	21.0	21.6	17.0	30.9	28.3	23.5	24.0	18.2	32.7	31.4	25.9	26.4	19.4			
	K.W.	3.03	2.90	2.86	2.84	2.78	2.98	2.85	2.83	2.80	2.76	2.92	2.80	2.80	2.77	2.74			
95 / 75	T.C.	28.8	32.7	31.5	36.6	39.2	29.6	31.7	30.6	36.0	38.1	30.5	30.7	29.8	35.4	37.1			
	S.C.	27.4	23.9	19.8	20.4	15.7	28.8	27.1	22.2	23.0	16.8	30.2	30.4	24.5	25.6	17.9			
	K.W.	3.29	3.20	3.13	3.11	3.05	3.24	3.13	3.09	3.07	3.02	3.19	3.06	3.06	3.03	2.99			
105 / 83	T.C.	25.6	28.5	27.8	32.8	35.3	26.1	27.7	26.8	31.7	33.9	26.5	26.9	25.7	30.5	32.4			
	S.C.	23.7	21.5	17.5	18.5	13.9	25.0	24.1	19.8	20.8	14.8	26.3	26.7	22.2	23.2	15.8			
	K.W.	3.61	3.55	3.49	3.48	3.41	3.56	3.49	3.46	3.44	3.39	3.50	3.43	3.44	3.40	3.36			
115 / 89	T.C.	22.5	24.4	24.2	29.1	31.6	22.6	23.8	23.0	27.5	29.8	22.7	23.2	21.8	25.8	27.9			
	S.C.	20.1	19.1	15.2	16.6	12.1	21.3	21.1	17.6	18.7	12.9	22.5	23.0	20.0	20.9	13.7			
	K.W.	3.92	3.88	3.84	3.83	3.77	3.87	3.83	3.82	3.79	3.74	3.81	3.78	3.80	3.76	3.72			
125 / 95	T.C.	19.4	20.4	20.6	25.5	27.9	19.2	20.0	19.3	23.2	25.7	18.9	19.6	17.9	21.0	23.4			
	S.C.	16.5	16.8	13.0	14.7	10.4	17.6	18.1	15.4	16.6	11.0	18.7	19.4	17.7	18.5	11.7			
	K.W.	4.23	4.22	4.19	4.19	4.13	4.17	4.18	4.18	4.15	4.10	4.11	4.14	4.17	4.12	4.07			

COOLING PERFORMANCE DATA - 3 TON (HIGH SPEED) - MODEL NO. PCG6B36																			
CONDENSER ENTERING AIR TEMPERATURE	ID CFM	1000						1200						1400					
	IDDB	80	80	75	80	80	80	80	75	80	80	80	80	75	80	80			
	IDWB	57	62	62	67	72	57	62	62	67	72	57	62	62	67	72			
55 / 45	T.C.	38.5	41.0	40.0	43.2	46.6	41.2	42.8	41.7	45.6	48.4	43.8	44.6	43.5	48.0	50.2			
	S.C.	36.0	32.3	27.5	27.7	0.6	38.3	35.5	30.0	29.9	12.8	40.6	38.7	32.5	32.0	25.0			
	K.W.	2.02	2.04	2.03	2.07	2.09	2.11	2.12	2.12	2.15	2.17	2.20	2.20	2.20	2.24	2.25			
65 / 55	T.C.	37.1	38.7	32.0	41.6	44.3	39.6	40.4	36.6	43.6	46.6	42.1	42.2	41.2	45.5	48.9			
	S.C.	34.6	31.4	25.6	26.7	11.6	36.8	34.7	28.6	29.1	17.9	39.0	38.0	31.7	31.4	24.1			
	K.W.	2.21	2.24	3.08	2.27	2.29	2.31	2.32	2.74	2.35	2.37	2.40	2.40	2.40	2.44	2.46			
75 / 63	T.C.	35.6	36.3	24.1	40.1	41.9	38.0	38.1	31.5	41.5	44.7	40.4	39.8	38.9	43.0	47.5			
	S.C.	33.3	30.5	23.7	25.7	22.5	35.3	33.9	27.3	28.2	22.9	37.4	37.3	30.9	30.8	23.3			
	K.W.	2.41	2.43	4.13	2.47	2.48	2.51	2.52	3.36	2.55	2.57	2.61	2.61	2.59	2.64	2.67			
85 / 69	T.C.	33.9	34.1	27.9	37.4	40.3	36.1	35.6	32.1	38.8	42.6	38.3	37.1	36.3	40.1	44.8			
	S.C.	31.6	29.4	23.5	24.6	20.5	33.4	32.5	26.5	27.0	21.3	35.3	35.7	29.5	29.5	22.2			
	K.W.	2.68	2.69	3.54	2.73	2.74	2.77	2.78	3.20	2.81	2.83	2.87	2.87	2.85	2.90	2.92			
95 / 75	T.C.	32.2	31.9	31.7	34.8	38.7	34.2	33.1	32.7	36.0	40.4	36.2	34.3	33.7	37.2	42.1			
	S.C.	29.8	28.2	23.2	23.4	18.5	31.5	31.2	25.7	25.8	19.8	33.2	34.1	28.1	28.2	21.1			
	K.W.	2.94	2.95	2.95	2.99	3.00	3.03	3.04	3.03	3.07	3.09	3.13	3.13	3.11	3.15	3.17			
105 / 83	T.C.	29.4	29.0	28.8	31.6	35.7	31.0	30.1	29.5	32.5	37.0	32.7	31.2	30.2	33.5	38.3			
	S.C.	27.8	26.5	21.8	22.0	17.1	29.2	28.7	24.0	24.3	18.3	30.7	30.9	26.3	26.6	19.6			
	K.W.	3.34	3.35	3.35	3.38	3.40	3.43	3.43	3.43	3.46	3.48	3.52	3.52	3.51	3.54	3.56			
115 / 89	T.C.	26.7	26.1	25.9	28.4	32.8	28.0	27.1	26.4	29.1	33.7	29.3	28.1	26.8	29.8	34.6			
	S.C.	25.7	24.8	20.4	20.5	15.8	27.0	26.4	22.4	22.8	16.9	28.2	27.9	24.5	25.2	18.1			
	K.W.	3.74	3.73	3.73	3.76	3.78	3.82	3.82	3.81	3.84	3.86	3.90	3.90	3.88	3.91	3.94			
125 / 95	T.C.	24.1	23.3	23.1	25.3	29.9	25.0	24.1	23.3	25.7	30.4	25.9	25.0	23.4	26.1	30.9			
	S.C.	23.7	23.1	18.9	19.1	14.4	24.7	24.0	20.9	21.4	15.5	25.7	24.8	22.8	23.7	16.6			
	K.W.	4.13	4.11	4.11	4.14	4.16	4.21	4.20	4.19	4.21	4.24	4.29	4.29	4.26	4.29	4.31			

COOLING PERFORMANCE DATA - 3.5 TON (LOW SPEED) - MODEL NO. PCG6B42																		
CONDENSER ENTERING AIR TEMPERATURE	ID CFM	800						1000						1200				
	IDDB	80	80	75	80	80	80	80	80	75	80	80	80	80	75	80	80	
	IDWB	57	62	62	67	72	57	62	62	67	72	57	62	62	67	72		
55 / 45	T.C.	30.2	33.8	24.4	36.3	39.4	33.3	36.0	26.3	37.9	40.4	36.4	38.2	28.1	39.5	41.3		
	S.C.	29.7	26.3	23.9	21.8	18.2	32.0	29.6	25.8	23.8	19.3	34.4	32.8	27.6	25.9	20.4		
	K.W.	0.97	0.96	0.93	0.98	0.98	0.97	0.97	0.94	1.00	1.00	0.97	0.97	0.94	1.01	1.01		
65 / 55	T.C.	27.7	32.0	23.2	34.8	37.3	30.3	34.0	25.4	36.6	38.9	32.8	36.0	27.6	38.4	40.6		
	S.C.	27.3	25.4	22.6	21.3	17.5	29.5	28.7	24.7	23.6	19.0	31.7	31.9	26.8	25.9	20.5		
	K.W.	1.13	1.11	1.09	1.14	1.10	1.13	1.12	1.09	1.15	1.11	1.12	1.13	1.09	1.15	1.13		
75 / 63	T.C.	25.2	30.1	22.1	33.3	35.1	27.2	32.0	24.6	35.3	37.5	29.2	33.9	27.1	37.3	40.0		
	S.C.	25.0	24.5	21.2	20.9	16.9	27.0	27.8	23.6	23.5	18.7	29.0	31.1	26.0	26.0	20.5		
	K.W.	1.29	1.26	1.25	1.29	1.22	1.28	1.27	1.24	1.30	1.23	1.27	1.28	1.24	1.30	1.25		
85 / 69	T.C.	22.4	27.0	21.1	31.1	34.4	24.1	29.0	23.5	33.0	35.8	25.9	31.0	26.0	34.9	37.2		
	S.C.	22.2	22.4	20.2	19.6	16.0	23.9	25.8	22.5	22.2	17.6	25.7	29.1	24.8	24.8	19.3		
	K.W.	1.48	1.47	1.45	1.49	1.43	1.48	1.48	1.45	1.49	1.44	1.48	1.49	1.45	1.50	1.45		
95 / 75	T.C.	19.6	23.9	20.1	28.9	33.8	21.0	26.0	22.5	30.7	34.1	22.5	28.2	24.8	32.5	34.4		
	S.C.	19.4	20.3	19.2	18.3	15.0	20.9	23.7	21.4	21.0	16.5	22.3	27.1	23.6	23.7	18.0		
	K.W.	1.67	1.68	1.66	1.68	1.63	1.69	1.69	1.66	1.69	1.64	1.70	1.70	1.66	1.70	1.65		
105 / 83	T.C.	17.0	20.4	18.8	25.0	29.8	18.6	22.2	21.1	27.0	31.3	20.2	23.9	23.4	29.0	32.9		
	S.C.	16.8	18.0	17.9	17.6	13.4	18.4	20.6	20.0	20.2	14.9	20.0	23.2	22.1	22.7	16.3		
	K.W.	1.94	1.94	1.92	1.94	1.90	1.95	1.95	1.92	1.95	1.91	1.96	1.96	1.93	1.95	1.92		
115 / 89	T.C.	14.5	17.0	17.5	21.2	25.8	16.2	18.4	19.8	23.4	28.7	18.0	19.8	22.0	25.6	31.5		
	S.C.	14.4	15.8	16.6	17.0	11.9	16.1	17.6	18.6	19.3	13.3	17.8	19.4	20.7	21.7	14.7		
	K.W.	2.19	2.20	2.17	2.19	2.16	2.20	2.20	2.18	2.20	2.17	2.21	2.21	2.19	2.20	2.18		
125 / 95	T.C.	12.0	13.6	16.2	17.4	21.9	13.9	14.7	18.5	19.8	26.0	15.8	15.8	20.7	22.1	30.1		
	S.C.	11.9	13.5	15.3	16.3	10.3	13.7	14.6	17.3	18.5	11.7	15.6	15.6	19.3	20.8	13.1		
	K.W.	2.45	2.45	2.42	2.44	2.42	2.46	2.46	2.44	2.45	2.43	2.47	2.47	2.46	2.45	2.44		

COOLING PERFORMANCE DATA - HIGH - 3.5 TON (HIGH SPEED) - MODEL NO. PCG6B42																		
CONDENSER ENTERING AIR TEMPERATURE	ID CFM	1120						1320						1520				
	IDDB	80	80	75	80	80	80	80	80	75	80	80	80	80	75	80	80	
	IDWB	57	62	62	67	72	57	62	62	67	72	57	62	62	67	72		
55 / 45	T.C.	43.6	47.7	30.8	50.0	55.0	45.8	49.6	31.8	51.4	55.8	48.1	51.4	32.8	52.8	56.7		
	S.C.	41.7	36.8	29.9	30.0	23.2	43.7	39.6	30.9	31.2	23.8	45.8	42.4	31.9	32.3	24.5		
	K.W.	2.19	2.22	2.17	2.16	2.16	2.29	2.30	2.26	2.22	2.21	2.39	2.39	2.36	2.27	2.26		
65 / 55	T.C.	39.9	45.2	31.1	49.1	53.4	41.9	47.2	32.4	50.5	55.0	44.0	49.3	33.6	51.8	56.7		
	S.C.	38.6	35.7	29.9	29.6	23.2	40.5	38.8	31.2	31.1	24.3	42.5	41.8	32.4	32.6	25.4		
	K.W.	2.44	2.46	2.43	2.42	2.46	2.54	2.56	2.53	2.48	2.54	2.64	2.65	2.64	2.54	2.61		
75 / 63	T.C.	36.1	42.7	31.4	48.3	51.8	38.0	44.9	33.0	49.6	54.2	39.9	47.1	34.5	50.8	56.6		
	S.C.	35.5	34.6	29.9	29.2	23.2	37.3	37.9	31.4	31.1	24.8	39.2	41.2	33.0	32.9	26.4		
	K.W.	2.68	2.71	2.69	2.67	2.77	2.79	2.81	2.80	2.74	2.86	2.90	2.91	2.91	2.80	2.95		
85 / 69	T.C.	33.3	39.4	30.5	45.2	49.9	35.2	41.2	32.4	46.2	52.0	37.0	42.9	34.3	47.3	54.0		
	S.C.	32.8	33.0	29.0	27.8	22.0	34.5	35.3	30.8	30.0	23.4	36.3	37.6	32.7	32.2	24.8		
	K.W.	3.02	3.03	3.05	3.04	3.09	3.12	3.13	3.16	3.12	3.18	3.22	3.22	3.26	3.20	3.28		
95 / 75	T.C.	30.5	36.0	29.7	42.0	48.0	32.3	37.4	31.9	42.9	49.7	34.1	38.8	34.1	43.8	51.4		
	S.C.	30.0	31.4	28.1	26.4	20.9	31.7	32.7	30.2	29.0	22.1	33.5	34.0	32.4	31.6	23.3		
	K.W.	3.35	3.35	3.40	3.41	3.41	3.45	3.45	3.51	3.50	3.51	3.54	3.54	3.61	3.59	3.60		
105 / 83	T.C.	27.9	32.6	28.2	38.0	44.3	29.5	33.5	30.4	38.7	45.5	31.0	34.4	32.5	39.4	46.8		
	S.C.	27.5	29.1	26.6	24.7	19.2	29.0	30.1	28.7	27.1	20.3	30.5	31.0	30.7	29.5	21.5		
	K.W.	3.81	3.81	3.87	3.82	3.86	3.90	3.90	3.97	3.90	3.96	4.00	4.00	4.07	3.97	4.05		
115 / 89	T.C.	25.4	29.3	26.8	34.1	40.6	26.7	29.7	28.9	34.7	41.5	28.0	30.1	31.0	35.2	42.4		
	S.C.	25.0	26.9	25.1	23.0	17.6	26.3	27.6	27.2	25.2	18.6	27.5	28.2	29.2	27.4	19.7		
	K.W.	4.25	4.25	4.32	4.21	4.30	4.35	4.34	4.42	4.28	4.39	4.44	4.44	4.52	4.35	4.49		
125 / 95	T.C.	22.9	25.9	25.4	30.3	37.0	24.0	25.9	27.4	30.6	37.5	25.1	25.8	29.5	30.9	37.9		
	S.C.	22.5	24.7	23.7	21.3	15.9	23.6	25.1	25.6	23.4	17.0	24.6	25.4	27.6	25.4	18.0		
	K.W.	4.69	4.69	4.78	4.61	4.74	4.79	4.78	4.87	4.67	4.83	4.89	4.88	4.97	4.73	4.93		

COOLING PERFORMANCE DATA - 4 TON (LOW SPEED) - MODEL NO. PCG6B48																
CONDENSER ENTERING AIR TEMPERATURE	ID CFM	900						1100				1300				
	IDDB	80	80	75	80	80	80	80	75	80	80	80	80	75	80	80
	IDWB	57	62	62	67	72	57	62	62	67	72	57	62	62	67	72
55 / 45	T.C.	34.3	37.4	36.3	41.1	45.6	37.5	39.7	38.7	43.6	48.0	40.6	42.1	41.1	46.2	50.3
	S.C.	32.3	28.7	24.7	24.9	20.0	34.8	32.1	27.2	27.2	21.8	37.4	35.5	29.8	29.6	23.6
	K.W.	1.67	1.64	1.65	1.63	1.49	1.63	1.61	1.62	1.59	1.52	1.58	1.58	1.58	1.56	1.55
65 / 55	T.C.	32.4	34.5	34.1	38.7	43.8	35.2	36.8	36.6	41.0	46.2	38.1	39.1	39.1	43.3	48.7
	S.C.	30.4	27.4	21.0	23.5	18.9	32.8	30.2	23.2	25.8	20.7	35.1	33.0	25.3	28.1	22.5
	K.W.	1.86	1.83	1.85	1.79	1.73	1.85	1.83	1.84	1.82	1.76	1.84	1.82	1.83	1.84	1.79
75 / 63	T.C.	30.4	31.6	32.0	36.3	42.0	33.0	33.9	34.5	38.4	44.5	35.5	36.2	37.1	40.4	47.0
	S.C.	28.6	26.0	17.4	22.1	17.8	30.7	28.2	19.1	24.4	19.6	32.9	30.5	20.8	26.6	21.5
	K.W.	2.05	2.03	2.04	1.96	1.97	2.07	2.05	2.06	2.05	2.01	2.10	2.06	2.08	2.13	2.04
85 / 69	T.C.	27.3	29.1	28.2	34.0	39.1	29.4	31.1	29.9	35.7	41.2	31.4	33.0	31.6	37.5	43.4
	S.C.	26.2	23.9	18.1	20.8	16.5	28.0	26.6	19.9	22.9	18.0	29.9	29.3	21.8	25.1	19.5
	K.W.	2.39	2.36	2.43	2.37	2.30	2.41	2.38	2.42	2.39	2.33	2.43	2.41	2.41	2.42	2.36
95 / 75	T.C.	24.2	26.7	24.5	31.6	36.1	25.8	28.2	25.3	33.1	37.9	27.4	29.7	26.2	34.6	39.7
	S.C.	23.8	21.8	18.8	19.4	15.1	25.4	25.0	20.8	21.5	16.4	26.9	28.2	22.8	23.6	17.6
	K.W.	2.72	2.68	2.82	2.78	2.63	2.74	2.72	2.78	2.74	2.65	2.76	2.75	2.74	2.70	2.68
105 / 83	T.C.	21.9	23.6	20.8	27.3	32.6	23.1	24.7	21.1	29.0	33.9	24.2	25.7	21.3	30.6	35.3
	S.C.	21.5	20.3	17.0	19.1	13.6	22.7	22.5	18.0	21.1	14.7	23.9	24.6	19.0	23.2	15.7
	K.W.	3.15	3.16	3.22	3.16	3.06	3.17	3.17	3.20	3.14	3.09	3.18	3.18	3.18	3.12	3.12
115 / 89	T.C.	19.6	20.6	17.1	23.2	29.2	20.4	21.2	16.9	25.0	30.1	21.2	21.8	16.6	26.8	31.1
	S.C.	19.3	18.8	15.1	18.8	12.2	20.1	20.0	15.3	20.8	13.0	20.9	21.1	15.4	22.7	13.9
	K.W.	3.56	3.63	3.60	3.53	3.47	3.58	3.61	3.60	3.53	3.51	3.59	3.60	3.60	3.53	3.54
125 / 95	T.C.	17.3	17.6	13.5	19.1	25.7	17.7	17.8	12.7	21.0	26.3	18.2	17.9	11.9	22.9	26.8
	S.C.	17.0	17.4	13.3	18.6	10.7	17.4	17.5	12.5	20.4	11.4	17.9	17.6	11.8	22.3	12.1
	K.W.	3.98	4.10	3.98	3.91	3.89	3.99	4.05	4.00	3.92	3.93	4.00	4.01	4.02	3.93	3.97

COOLING PERFORMANCE DATA - HIGH - 4 TON (HIGH SPEED) - MODEL NO. PCG6B48																
CONDENSER ENTERING AIR TEMPERATURE	ID CFM	1400						1600				1800				
	IDDB	80	80	75	80	80	80	80	75	80	80	80	80	75	80	80
	IDWB	57	62	62	67	72	57	62	62	67	72	57	62	62	67	72
55 / 45	T.C.	46.5	54.3	55.5	56.6	59.6	47.9	54.3	55.6	56.8	59.9	49.2	54.3	55.6	56.9	60.1
	S.C.	45.7	41.3	35.4	35.0	27.8	47.2	43.3	36.8	35.0	28.0	48.7	45.2	38.2	35.0	28.1
	K.W.	2.66	2.72	2.72	2.93	2.75	2.76	2.80	2.80	2.92	2.82	2.86	2.88	2.87	2.90	2.89
65 / 55	T.C.	43.8	51.2	52.2	54.8	58.3	44.9	51.7	52.7	54.8	58.7	46.1	52.1	53.3	54.9	59.1
	S.C.	43.3	40.2	34.1	33.8	27.0	44.3	35.9	37.0	34.7	31.7	45.3	31.7	40.0	35.5	36.5
	K.W.	2.93	3.06	2.98	3.11	3.13	3.03	3.06	3.06	3.15	3.16	3.13	3.06	3.14	3.19	3.20
75 / 63	T.C.	41.1	48.2	48.8	52.9	56.9	42.0	49.1	49.9	52.9	57.5	43.0	49.9	51.0	52.8	58.1
	S.C.	41.0	39.1	32.9	32.6	26.1	41.5	28.6	37.3	34.3	35.5	41.9	18.2	41.8	36.0	44.9
	K.W.	3.19	3.39	3.24	3.29	3.51	3.29	3.32	3.33	3.38	3.51	3.39	3.25	3.41	3.47	3.50
85 / 69	T.C.	40.3	45.2	46.3	49.4	53.8	40.1	45.6	46.8	49.2	54.0	39.9	46.1	47.2	48.9	54.2
	S.C.	39.8	37.3	31.1	31.2	24.6	39.4	33.1	34.1	32.8	29.8	39.1	28.9	37.2	34.4	34.9
	K.W.	3.55	3.66	3.58	3.72	3.77	3.64	3.67	3.66	3.77	3.81	3.74	3.67	3.75	3.81	3.85
95 / 75	T.C.	39.4	42.2	43.8	45.9	50.7	38.1	42.2	43.6	45.5	50.5	36.8	42.3	43.4	45.1	50.3
	S.C.	38.6	35.5	29.3	29.7	23.1	37.4	37.6	30.9	31.2	24.1	36.2	39.7	32.6	32.7	25.0
	K.W.	3.91	3.93	3.92	4.15	4.03	4.00	4.01	4.00	4.15	4.11	4.09	4.09	4.08	4.15	4.19
105 / 83	T.C.	34.6	37.5	39.1	41.7	46.5	34.0	37.9	39.0	41.3	46.1	33.4	38.3	38.9	40.9	45.7
	S.C.	34.0	33.1	27.4	27.8	21.2	33.4	34.8	26.2	29.3	22.0	32.9	36.5	25.1	30.9	22.9
	K.W.	4.42	4.49	4.43	4.65	4.58	4.51	4.54	4.47	4.65	4.63	4.59	4.60	4.52	4.65	4.68
115 / 89	T.C.	29.9	33.0	34.6	37.7	42.4	30.0	33.8	34.5	37.2	41.8	30.1	34.5	34.5	36.8	41.2
	S.C.	29.5	30.7	25.5	26.0	19.3	29.6	32.1	21.7	27.6	20.1	29.8	33.5	17.9	29.1	20.8
	K.W.	4.91	5.03	4.92	5.14	5.12	5.00	5.06	4.94	5.13	5.14	5.09	5.09	4.95	5.13	5.17
125 / 95	T.C.	25.2	28.4	30.1	33.6	38.2	26.0	29.6	30.1	33.2	37.5	26.8	30.7	30.1	32.7	36.7
	S.C.	25.0	28.4	23.6	24.2	17.5	25.8	29.4	17.1	25.8	18.1	26.6	30.4	10.6	27.3	18.8
	K.W.	5.41	5.58	5.41	5.62	5.66	5.50	5.58	5.40	5.62	5.66	5.58	5.58	5.39	5.62	5.65

COOLING PERFORMANCE DATA - 5 TON (LOW SPEED) - MODEL NO. PCG6B60																			
CONDENSER ENTERING AIR TEMPERATURE	ID CFM	1100						1300						1500					
	IDDB	80	80	75	80	80	80	80	75	80	80	80	80	75	80	80			
	IDWB	57	62	62	67	72	57	62	62	67	72	57	62	62	67	72			
55 / 45	T.C.	44.6	51.1	50.5	55.7	59.9	47.1	53.0	51.7	57.4	61.8	49.5	54.9	53.0	59.2	63.8			
	S.C.	44.6	43.1	36.8	36.5	30.0	47.1	47.5	40.0	39.4	31.6	49.5	51.8	43.3	42.4	33.3			
	K.W.	1.77	1.77	1.77	1.74	1.90	1.87	1.87	1.88	1.84	1.92	1.98	1.98	1.99	1.94	1.94			
65 / 55	T.C.	42.1	47.6	46.8	52.1	57.3	44.3	49.4	48.4	53.9	59.6	46.6	51.2	50.1	55.7	61.9			
	S.C.	42.1	41.4	35.0	34.9	28.5	44.3	45.6	38.1	37.8	30.2	46.6	49.9	41.2	40.8	31.9			
	K.W.	2.05	2.05	2.14	2.11	2.08	2.15	2.15	2.20	2.16	2.14	2.25	2.24	2.25	2.22	2.20			
75 / 63	T.C.	39.6	44.2	43.1	48.5	54.8	41.6	45.8	45.1	50.3	57.4	43.7	47.4	47.1	52.1	60.1			
	S.C.	39.6	39.6	33.3	33.3	26.9	41.6	43.8	36.2	36.2	28.7	43.7	47.4	39.1	39.2	30.4			
	K.W.	2.34	2.33	2.51	2.48	2.26	2.43	2.42	2.51	2.48	2.36	2.52	2.51	2.52	2.49	2.45			
85 / 69	T.C.	36.5	40.6	39.8	44.8	50.8	38.3	41.8	41.5	46.3	53.0	40.1	43.0	43.2	47.9	55.1			
	S.C.	36.5	37.6	31.4	31.4	25.1	38.3	40.9	34.2	34.3	26.8	40.1	43.0	37.0	37.2	28.6			
	K.W.	2.69	2.67	2.87	2.74	2.61	2.78	2.77	2.87	2.79	2.71	2.87	2.88	2.88	2.84	2.81			
95 / 75	T.C.	33.4	37.0	36.4	41.0	46.9	35.0	37.8	37.8	42.3	48.5	36.5	38.6	39.3	43.6	50.2			
	S.C.	33.4	35.5	29.5	29.5	23.2	35.0	37.8	32.2	32.3	25.0	36.5	38.6	34.9	35.1	26.7			
	K.W.	3.04	3.02	3.23	3.00	2.96	3.13	3.13	3.23	3.10	3.07	3.22	3.25	3.24	3.20	3.17			
105 / 83	T.C.	30.0	34.0	32.7	36.5	42.1	31.3	34.3	33.6	37.3	43.3	32.7	34.6	34.5	38.1	44.6			
	S.C.	30.0	32.8	27.2	27.4	21.2	31.3	34.3	29.6	30.1	22.7	32.7	34.6	32.0	32.9	24.3			
	K.W.	3.56	3.48	3.62	3.46	3.43	3.62	3.59	3.66	3.56	3.53	3.69	3.70	3.70	3.66	3.63			
115 / 89	T.C.	26.7	31.1	29.0	32.1	37.4	27.8	30.9	29.4	32.5	38.3	28.9	30.6	29.9	32.8	39.1			
	S.C.	26.7	30.3	25.0	25.4	19.2	27.8	30.9	27.1	28.0	20.6	28.9	30.6	29.2	30.7	21.9			
	K.W.	4.07	3.93	4.00	3.91	3.87	4.10	4.03	4.07	4.01	3.98	4.13	4.13	4.14	4.11	4.09			
125 / 95	T.C.	23.4	28.3	25.3	27.7	32.7	24.3	27.5	25.3	27.6	33.2	25.1	26.7	25.2	27.5	33.7			
	S.C.	23.4	27.7	22.8	23.4	17.2	24.3	27.5	24.6	25.9	18.4	25.1	26.7	25.2	27.5	19.6			
	K.W.	4.57	4.38	4.39	4.35	4.32	4.58	4.47	4.49	4.46	4.43	4.58	4.57	4.59	4.56	4.54			

COOLING PERFORMANCE DATA - 5 TON (HIGH SPEED) - MODEL NO. PCG6B60																			
CONDENSER ENTERING AIR TEMPERATURE	ID CFM	1600						1800						2000					
	IDDB	80	80	75	80	80	80	80	75	80	80	80	80	75	80	80			
	IDWB	57	62	62	67	72	57	62	62	67	72	57	62	62	67	72			
55 / 45	T.C.	59.2	68.9	66.5	71.8	77.1	61.3	70.6	67.6	73.5	77.7	63.5	72.3	68.8	75.1	78.3			
	S.C.	59.2	55.8	47.0	46.7	37.2	61.3	59.6	49.6	49.1	38.2	63.5	63.4	52.2	51.5	39.1			
	K.W.	2.80	2.86	2.87	3.21	2.93	3.03	3.08	3.08	3.28	3.14	3.26	3.30	3.30	3.34	3.35			
65 / 55	T.C.	54.3	64.1	61.7	68.4	74.2	55.7	66.1	63.2	69.9	75.5	57.2	68.1	64.7	71.3	76.9			
	S.C.	54.3	53.9	45.4	44.9	35.7	55.7	42.9	51.1	47.3	46.7	57.2	31.9	56.8	49.8	57.8			
	K.W.	3.07	3.25	3.13	3.34	3.37	3.30	3.34	3.35	3.48	3.51	3.53	3.42	3.56	3.62	3.66			
75 / 63	T.C.	49.3	59.2	57.0	65.1	71.3	50.1	61.6	58.8	66.3	73.4	50.9	64.0	60.6	67.4	75.4			
	S.C.	49.3	52.0	43.7	43.0	34.2	50.1	26.2	52.5	45.5	55.3	50.9	0.3	60.6	48.0	75.4			
	K.W.	3.33	3.65	3.39	3.47	3.81	3.57	3.60	3.61	3.68	3.89	3.80	3.55	3.83	3.90	3.97			
85 / 69	T.C.	48.7	55.4	53.9	60.5	67.1	47.8	57.3	55.3	61.5	68.6	46.8	59.2	56.8	62.4	70.2			
	S.C.	48.7	49.6	41.4	41.0	32.2	47.8	38.2	47.0	43.3	43.3	46.8	26.7	52.7	45.7	54.5			
	K.W.	3.71	3.87	3.74	3.95	4.02	3.94	3.96	3.96	4.10	4.17	4.16	4.04	4.17	4.25	4.32			
95 / 75	T.C.	48.0	51.6	50.7	55.9	62.8	45.4	53.0	51.8	56.7	63.9	42.8	54.3	53.0	57.4	64.9			
	S.C.	48.0	47.2	39.1	39.1	30.3	45.4	50.1	41.5	41.2	31.4	42.8	53.0	43.9	43.3	32.6			
	K.W.	4.09	4.10	4.09	4.44	4.23	4.30	4.31	4.30	4.52	4.44	4.52	4.53	4.51	4.60	4.66			
105 / 83	T.C.	42.5	46.6	45.9	50.9	57.9	40.7	48.1	47.1	51.6	58.7	38.9	49.5	48.3	52.3	59.6			
	S.C.	42.5	43.9	36.8	36.9	28.2	40.7	46.3	33.0	39.0	29.3	38.9	48.7	29.1	41.1	30.4			
	K.W.	4.60	4.71	4.61	4.96	4.84	4.82	4.87	4.77	5.04	5.00	5.03	5.04	4.92	5.11	5.17			
115 / 89	T.C.	37.0	41.8	41.3	46.0	53.1	36.1	43.4	42.5	46.7	53.8	35.1	44.9	43.8	47.4	54.4			
	S.C.	37.0	40.7	34.7	34.7	26.2	36.1	42.6	24.7	36.9	27.2	35.1	44.5	14.7	39.0	28.2			
	K.W.	5.10	5.29	5.12	5.46	5.43	5.32	5.42	5.23	5.54	5.54	5.54	5.54	5.33	5.61	5.66			
125 / 95	T.C.	31.6	37.0	36.6	41.1	48.2	31.5	38.6	37.9	41.8	48.8	31.4	40.2	39.3	42.5	49.3			
	S.C.	31.6	37.0	32.5	32.6	24.2	31.5	38.6	16.4	34.7	25.1	31.4	40.2	0.3	36.8	26.1			
	K.W.	5.60	5.88	5.63	5.96	6.01	5.82	5.96	5.68	6.04	6.09	6.04	6.04	5.74	6.11	6.16			

UNIT DIMENSIONS AND ACCESS LOCATIONS

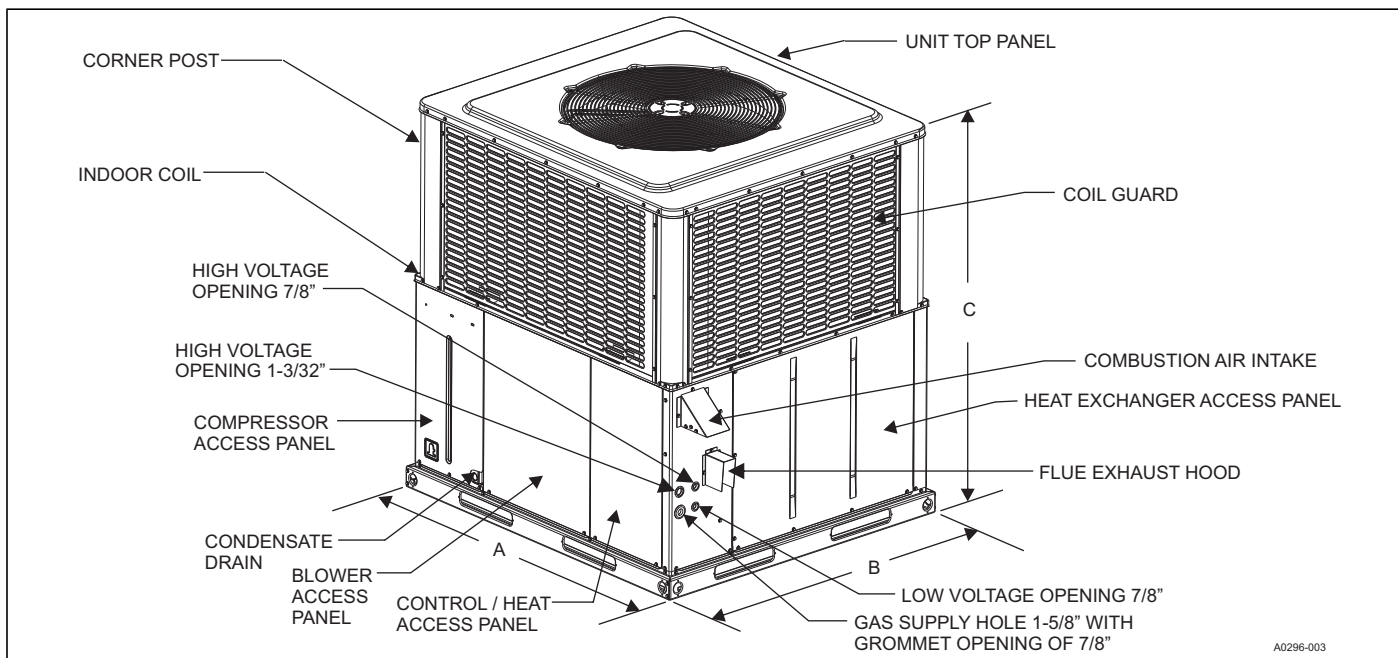

UNIT DIMENSIONS

Model	Dimensions		
	A	B	C
36	51-1/4	45-3/4	49
42	51-1/4	45-3/4	49
48	51-1/4	45-3/4	53
60	51-1/4	45-3/4	55

UNIT CLEARANCES^{1 2}

Direction	Distance (in.)	Direction	Distance (in.)
Top ³	36	Power Entry (Right Side)	36
Side Opposite Ducts	36	Left Side	24
Duct Panel	0	Bottom ⁴	1

NOTES:

1. A 1" clearance must be provided between any combustible material and the supply air duct work.
2. The products of combustion must not be allowed to accumulate within a confined space and recirculate.
3. Units must be installed outdoors. Over hanging structure or shrubs should not obstruct condenser air discharge outlet.
4. Units may be installed on combustible materials made from wood or class A, B or C roof covering materials only if factory base rails are left in place as shipped.

INDOOR BLOWER SPECIFICATIONS

Model	Motor				
	HP	RPM	EFF.	SF	Frame
36065, 36100	1/2	Variable	0.8	1.0	48
42065, 42100, 48065, 48100, 48125, 60065, 60100, 60125	1	Variable	0.8	1.0	48

SOUND PERFORMANCE

Model (Tons)	Sound Rating ¹ dB (A)	Octave Band Centerline Frequency (Hz)						
		125	250	500	1000	2000	4000	8000
36	74	58.5	61.8	65.4	66.5	60.7	54.8	49.8
42	74	63.5	63.9	62.3	65	64	54.1	46.6
48	74	63.5	63.9	62.3	65	64	54.1	46.6
60	76	72.3	65.0	63.9	64	60	55.5	49.0

NOTES:

1. Rated in accordance with AHRI Standard 270.

ELECTRICAL DATA

Model	Voltage	Compressor			OD Fan Motor	Supply Blower Motor	MCA ¹ (Amps)	Max Fuse ² / Breaker ³ Size (Amps)
		RLA	LRA	MCC	FLA	FLA		
36065, 36100	460-3-60	5.7	38.0	8.9	0.87	1.9	9.9	15
42065, 42100	460-3-60	6.2	44.0	9.7	0.87	3.3	12.2	15
48065, 48100, 48125	460-3-60	6.4	41.0	10.0	0.87	3.3	12.2	15
60065, 60100, 60125	460-3-60	7.6	52.0	11.9	0.87	3.3	13.7	20

NOTES:

1. Minimum Circuit Ampacity.
2. Maximum Over Current Protection per standard UL 1995.
3. Fuse or HACR circuit breaker.

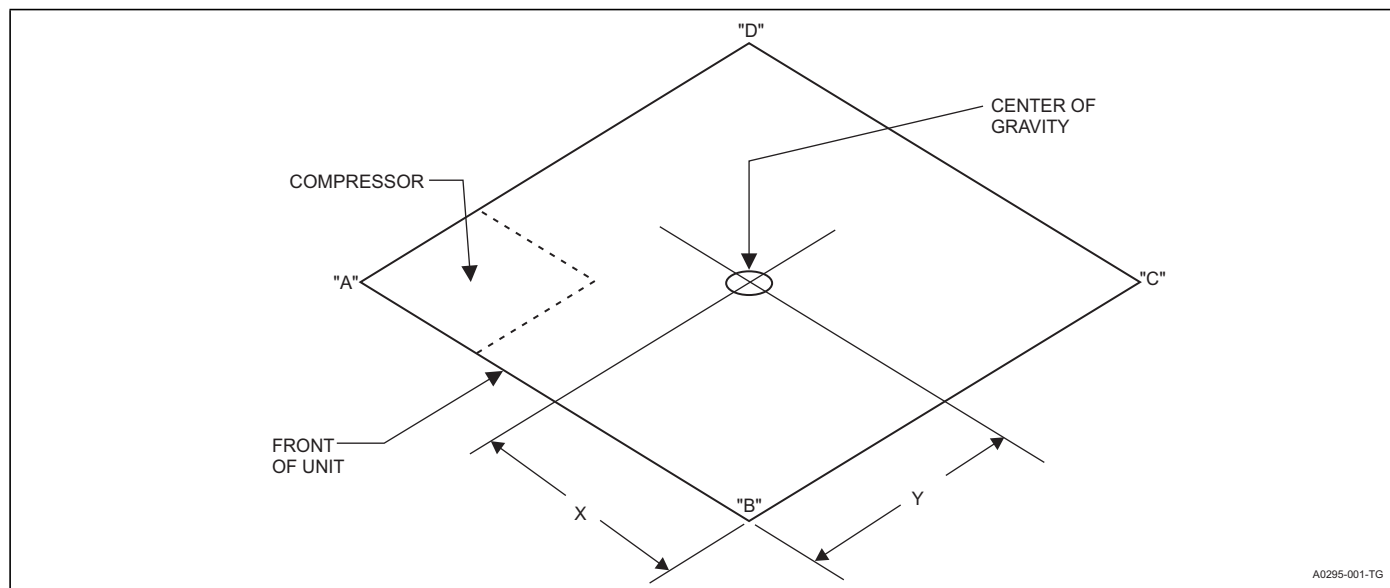
WEIGHTS & DIMENSIONS**WEIGHTS & DIMENSIONS**

Model	Weight (lbs.)		Center of Gravity		4 Point Load Location (lbs.)			
	Shipping	Operating	X	Y	A	B	C	D
36065	466	461	28	15	161	113	96	91
36100	473	468	28	15	163	114	101	90
42065	500	495	28	15	175	123	104	93
42100	502	497	28	15	176	124	101	96
48065	520	515	28	15	189	116	93	117
48100	528	523	28	15	169	139	115	100
48125	533	528	28	15	164	145	124	95
60065	537	532	29	15	174	142	124	92
60100	541	536	28	15	177	140	117	102
60125	548	543	27	15	151	167	141	84

AIRFLOW PERFORMANCE - SIDE DUCT APPLICATION

Model	Jumper Position	External Static Pressure (Inches WC)										
		0.1 SCFM	0.2 SCFM	0.3 SCFM	0.4 SCFM	0.5 SCFM	0.6 SCFM	0.7 SCFM	0.8 SCFM	0.9 SCFM	1.0 SCFM	
36065	High Cool	A	1621	1531	1454	1371	1299	1223	1138	1039	966	869
		B	1507	1418	1339	1268	1200	1130	1059	981	911	837
		C	1410	1288	1209	1132	1054	982	904	831	755	691
		D	1469	1378	1297	1225	1153	1083	1014	941	870	802
	Low Cool	A	1204	1117	1032	958	881	804	728	655	586	525
		B	1122	1030	945	866	783	703	623	544	479	416
		C	1046	949	863	777	687	605	521	445	379	313
		D	813	721	617	509	404	323	237	171	81	81
	High Heat	A	1184	1096	1012	938	861	783	708	628	560	501
		B	1110	1017	932	852	768	687	606	527	462	399
		C	1060	964	879	795	706	623	538	459	397	331
		D	902	802	700	602	504	429	348	292	201	201
	Low Heat	A	769	680	575	463	354	270	182	111	21	21
		B	690	604	495	373	257	171	171	171	171	171
		C	610	528	414	283	159	72	72	72	72	72
		D	544	465	345	206	76	76	76	76	76	76
36100	High Cool	A	1621	1531	1454	1371	1299	1223	1138	1039	966	869
		B	1507	1418	1339	1268	1200	1130	1059	981	911	837
		C	1410	1288	1209	1132	1054	982	904	831	755	691
		D	1469	1378	1297	1225	1153	1083	1014	941	870	802
	Low Cool	A	1204	1117	1032	958	881	804	728	655	586	525
		B	1122	1030	945	866	783	703	623	544	479	416
		C	1046	949	863	777	687	605	521	445	379	313
		D	813	721	617	509	404	323	237	171	81	81
	High Heat	A	1632	1554	1474	1385	1308	1227	1141	1043	967	870
		B	1447	1344	1264	1190	1116	1045	973	900	827	760
		C	1507	1418	1339	1268	1200	1130	1059	981	911	837
		D	1432	1322	1242	1167	1091	1020	945	872	798	733
	Low Heat	A	1184	1096	1012	938	861	783	708	628	560	501
		B	1072	977	892	809	721	639	555	476	413	348
		C	1122	1030	945	866	783	703	623	544	479	416
		D	1031	934	846	759	669	587	504	430	362	294
42065	High Cool	A	1687	1631	1575	1525	1469	1414	1362	1302	1239	1173
		B	1621	1561	1495	1442	1384	1326	1269	1202	1136	1064
		C	1542	1477	1409	1349	1288	1218	1162	1098	1035	960
		D	1423	1351	1281	1211	1143	1056	1002	941	883	804
	Low Cool	A	1175	1090	1011	925	846	728	679	622	569	480
		B	1125	1039	957	870	791	672	623	564	507	416
		C	1075	988	902	816	735	615	566	506	446	351
		D	1125	1039	957	870	791	672	623	564	507	416
	High Heat	A	1225	1141	1066	980	902	785	736	681	630	544
		B	1150	1065	984	898	818	700	651	593	538	448
		C	975	886	793	706	624	501	453	389	323	223
		D	1075	988	902	816	735	615	566	506	446	351
	Low Heat	A	941	851	756	667	584	458	410	410	410	410
		B	840	745	643	550	464	329	282	282	282	282
		C	806	710	606	512	424	286	239	239	239	239
		D	671	569	456	356	264	113	68	68	68	68

Continued on next page. See notes at end of table.

AIRFLOW PERFORMANCE - SIDE DUCT APPLICATION (Continued)

Model	Jumper Position	External Static Pressure (Inches WC)										
		0.1	0.2	0.3	0.4	0.5	0.6	0.7	0.8	0.9	1.0	
		SCFM	SCFM	SCFM	SCFM	SCFM	SCFM	SCFM	SCFM	SCFM	SCFM	
42100	High Cool	A	1687	1631	1575	1525	1469	1414	1362	1302	1239	1173
		B	1621	1561	1495	1442	1384	1326	1269	1202	1136	1064
		C	1542	1477	1409	1349	1288	1218	1162	1098	1035	960
		D	1423	1351	1281	1211	1143	1056	1002	941	883	804
	Low Cool	A	1175	1090	1011	925	846	728	679	622	569	480
		B	1125	1039	957	870	791	672	623	564	507	416
		C	1075	988	902	816	735	615	566	506	446	351
		D	1125	1039	957	870	791	672	623	564	507	416
	High Heat	A	1909	1860	1820	1780	1734	1690	1642	1594	1547	1492
		B	1769	1719	1674	1629	1576	1525	1478	1427	1367	1308
		C	1638	1579	1515	1463	1406	1348	1292	1227	1162	1091
		D	1671	1614	1555	1504	1448	1392	1339	1277	1213	1145
	Low Heat	A	1304	1225	1152	1072	998	893	842	785	731	648
		B	1225	1141	1066	980	902	785	736	681	630	544
		C	1150	1065	984	898	818	700	651	593	538	448
		D	1075	988	902	816	735	615	566	506	446	351
48065	High Cool	A	1974	1925	1884	1842	1797	1749	1700	1651	1605	1550
		B	1785	1737	1694	1650	1597	1547	1501	1452	1392	1335
		C	1703	1649	1595	1546	1491	1436	1385	1327	1264	1200
		D	1654	1596	1535	1483	1427	1370	1315	1252	1187	1118
	Low Cool	A	1423	1351	1281	1211	1143	1056	1002	941	883	804
		B	1344	1267	1195	1118	1046	947	896	837	782	700
		C	1225	1141	1066	980	902	785	736	681	630	544
		D	1304	1225	1152	1072	998	893	842	785	731	648
	High Heat	A	1225	1141	1066	980	902	785	736	681	630	544
		B	1150	1065	984	898	818	700	651	593	538	448
		C	975	886	793	706	624	501	453	389	323	223
		D	1075	988	902	816	735	615	566	506	446	351
	Low Heat	A	941	851	756	667	584	458	410	410	410	410
		B	840	745	643	550	464	329	282	282	282	282
		C	806	710	606	512	424	286	239	239	239	239
		D	671	569	456	356	264	113	68	68	68	68
48100	High Cool	A	1974	1925	1884	1842	1797	1749	1700	1651	1605	1550
		B	1785	1737	1694	1650	1597	1547	1501	1452	1392	1335
		C	1703	1649	1595	1546	1491	1436	1385	1327	1264	1200
		D	1654	1596	1535	1483	1427	1370	1315	1252	1187	1118
	Low Cool	A	1423	1351	1281	1211	1143	1056	1002	941	883	804
		B	1344	1267	1195	1118	1046	947	896	837	782	700
		C	1225	1141	1066	980	902	785	736	681	630	544
		D	1304	1225	1152	1072	998	893	842	785	731	648
	High Heat	A	1832	1783	1741	1699	1648	1600	1554	1506	1450	1394
		B	1769	1719	1674	1629	1576	1525	1478	1427	1367	1308
		C	1638	1579	1515	1463	1406	1348	1292	1227	1162	1091
		D	1621	1561	1495	1442	1384	1326	1269	1202	1136	1064
	Low Heat	A	1344	1267	1195	1118	1046	947	896	837	782	700
		B	1225	1141	1066	980	902	785	736	681	630	544
		C	1150	1065	984	898	818	700	651	593	538	448
		D	1075	988	902	816	735	615	566	506	446	351

Continued on next page. See notes at end of table.

AIRFLOW PERFORMANCE - SIDE DUCT APPLICATION (Continued)

Model	Jumper Position		External Static Pressure (Inches WC)									
			0.1	0.2	0.3	0.4	0.5	0.6	0.7	0.8	0.9	1.0
			SCFM	SCFM	SCFM	SCFM	SCFM	SCFM	SCFM	SCFM	SCFM	SCFM
48125	High Cool	A	1974	1925	1884	1842	1797	1749	1700	1651	1605	1550
		B	1785	1737	1694	1650	1597	1547	1501	1452	1392	1335
		C	1703	1649	1595	1546	1491	1436	1385	1327	1264	1200
		D	1654	1596	1535	1483	1427	1370	1315	1252	1187	1118
	Low Cool	A	1423	1351	1281	1211	1143	1056	1002	941	883	804
		B	1344	1267	1195	1118	1046	947	896	837	782	700
		C	1225	1141	1066	980	902	785	736	681	630	544
		D	1304	1225	1152	1072	998	893	842	785	731	648
	High Heat	A	2342	2301	2255	2217	2172	2124	2070	2017	1969	1925
		B	2182	2137	2090	2038	1986	1929	1880	1822	1771	1716
		C	2171	2124	2077	2025	1973	1915	1866	1808	1756	1701
		D	1991	1942	1900	1857	1810	1761	1712	1661	1615	1559
	Low Heat	A	1862	1814	1772	1731	1683	1636	1589	1541	1489	1433
		B	1703	1649	1595	1546	1491	1436	1385	1327	1264	1200
		C	1638	1579	1515	1463	1406	1348	1292	1227	1162	1091
		D	1542	1477	1409	1349	1288	1218	1162	1098	1035	960
60065	High Cool	A	2342	2290	2247	2190	2121	2096	2028	1976	1918	1872
		B	2079	2038	1997	1958	1902	1860	1817	1778	1731	1692
		C	1848	1805	1751	1698	1664	1614	1562	1519	1475	1430
		D	1949	1902	1856	1805	1769	1718	1663	1626	1577	1537
	Low Cool	A	1589	1529	1471	1416	1372	1320	1269	1219	1167	1128
		B	1413	1352	1295	1240	1187	1130	1073	1015	959	905
		C	1262	1201	1140	1080	1018	958	898	839	784	729
		D	1413	1352	1295	1240	1187	1130	1073	1015	959	905
	High Heat	A	1479	1418	1361	1306	1256	1201	1147	1092	1037	989
		B	1391	1329	1273	1218	1164	1106	1049	990	933	877
		C	1289	1227	1168	1109	1049	989	930	871	815	759
		D	1182	1121	1056	993	927	866	804	746	691	639
	Low Heat	A	1262	1201	1140	1080	1018	958	898	839	784	729
		B	1102	1041	973	905	835	773	709	652	599	549
		C	976	907	836	762	684	623	547	486	427	371
		D	926	854	781	705	623	563	483	419	358	300
60100	High Cool	A	2342	2290	2247	2190	2121	2096	2028	1976	1918	1872
		B	2079	2038	1997	1958	1902	1860	1817	1778	1731	1692
		C	1848	1805	1751	1698	1664	1614	1562	1519	1475	1430
		D	1949	1902	1856	1805	1769	1718	1663	1626	1577	1537
	Low Cool	A	1589	1529	1471	1416	1372	1320	1269	1219	1167	1128
		B	1413	1352	1295	1240	1187	1130	1073	1015	959	905
		C	1262	1201	1140	1080	1018	958	898	839	784	729
		D	1413	1352	1295	1240	1187	1130	1073	1015	959	905
	High Heat	A	1978	1932	1888	1839	1799	1749	1697	1660	1611	1571
		B	1900	1854	1805	1752	1718	1667	1612	1573	1526	1484
		C	1779	1740	1679	1626	1592	1543	1495	1447	1407	1358
		D	1693	1646	1585	1531	1493	1443	1395	1345	1301	1256
	Low Heat	A	1658	1607	1547	1493	1453	1402	1353	1303	1256	1213
		B	1369	1307	1251	1196	1141	1082	1024	964	907	849
		C	1289	1227	1168	1109	1049	989	930	871	815	759
		D	1391	1329	1273	1218	1164	1106	1049	990	933	877

Continued on next page. See notes at end of table.

AIRFLOW PERFORMANCE - SIDE DUCT APPLICATION (Continued)

Model	Jumper Position	External Static Pressure (Inches WC)										
		0.1	0.2	0.3	0.4	0.5	0.6	0.7	0.8	0.9	1.0	
		SCFM	SCFM	SCFM	SCFM	SCFM	SCFM	SCFM	SCFM	SCFM	SCFM	
60125	High Cool	A	2342	2290	2247	2190	2121	2096	2028	1976	1918	1872
		B	2079	2038	1997	1958	1902	1860	1817	1778	1731	1692
		C	1848	1805	1751	1698	1664	1614	1562	1519	1475	1430
		D	1949	1902	1856	1805	1769	1718	1663	1626	1577	1537
	Low Cool	A	1589	1529	1471	1416	1372	1320	1269	1219	1167	1128
		B	1413	1352	1295	1240	1187	1130	1073	1015	959	905
		C	1262	1201	1140	1080	1018	958	898	839	784	729
		D	1413	1352	1295	1240	1187	1130	1073	1015	959	905
	High Heat	A	2293	2244	2203	2154	2093	2062	2015	1957	1904	1861
		B	2198	2156	2113	2070	2015	1967	1943	1898	1849	1808
		C	2050	2008	1966	1924	1872	1828	1783	1744	1697	1658
		D	2007	1963	1919	1873	1828	1781	1731	1693	1646	1606
	Low Heat	A	1797	1756	1697	1644	1610	1561	1512	1465	1424	1376
		B	1641	1588	1528	1474	1432	1382	1332	1282	1234	1192
		C	1589	1529	1471	1416	1372	1320	1269	1219	1167	1128
		D	1523	1463	1405	1350	1302	1248	1196	1143	1089	1044

NOTES:

1. Airflow tested with dry coil conditions, without air filters, at 460 volts
2. Applications above 0.8" w.c. external static pressure are not recommended.
3. Brushless DC high efficiency standard ECM blower motor used for all indoor blower assemblies.
4. Minimal variations in airflow performance data results from using downflow duct applications. Data above may be used in those cases.
5. Heating applications tested at 0.50" w.c. esp, and cooling applications tested at 0.30" w.c. esp per standards.

ADDITIONAL STATIC RESISTANCE

Size (Tons)	CFM	Wet Indoor Coil	Economizer ¹	Filter/Frame Kit
036 (3.0)	700	0.01	0.00	0.04
	800	0.02	0.01	0.06
	900	0.03	0.01	0.08
	1000	0.04	0.01	0.10
	1100	0.05	0.01	0.13
	1200	0.06	0.02	0.16
	1300	0.07	0.03	0.17
	1400	0.08	0.04	0.18
042 (3.5)	1100	0.02	0.02	0.04
	1200	0.03	0.02	0.04
	1300	0.04	0.02	0.05
	1400	0.05	0.03	0.05
	1500	0.06	0.04	0.06
	1600	0.07	0.04	0.07
	1700	0.07	0.04	0.08
	1800	0.08	0.04	0.09
048 (4.0)	1900	0.09	0.05	0.10
	2000	0.09	0.05	0.11
	1100	0.02	0.02	0.04
	1200	0.03	0.02	0.04
	1300	0.04	0.02	0.05
	1400	0.05	0.03	0.05
	1500	0.06	0.04	0.06
	1600	0.07	0.04	0.07
060 (5.0)	1700	0.07	0.04	0.08
	1800	0.08	0.04	0.09
	1900	0.09	0.05	0.10
	2000	0.09	0.05	0.11

NOTES:

1. The pressure drop through the economizer is greater for 100% outdoor air than for 100% return air. If the resistance of the return air duct is less than 0.25 IWG, the unit will deliver less CFM during full economizer operation. Filter pressure drop based on standard filter media tested at velocities not to exceed 300 ft/min.

BOTTOM DUCT DIMENSIONS (Inches)

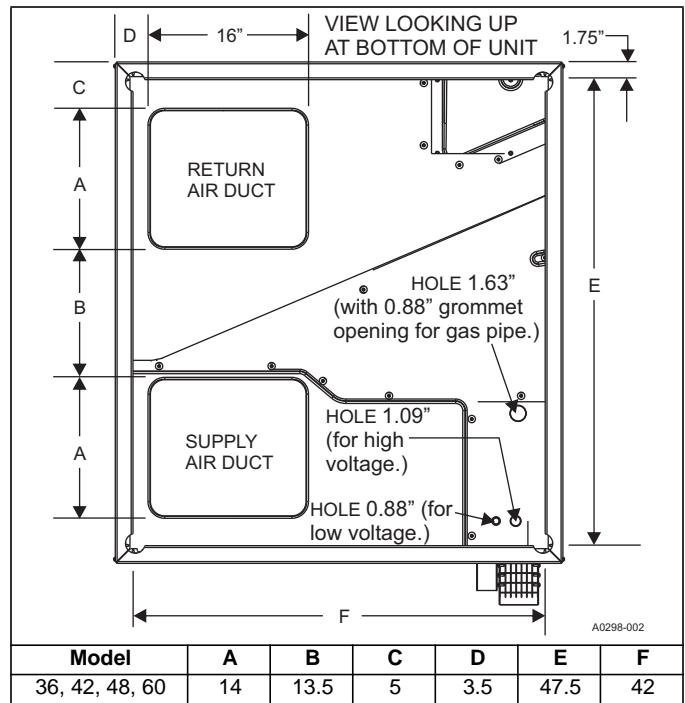

REAR DUCT DIMENSIONS (Inches)

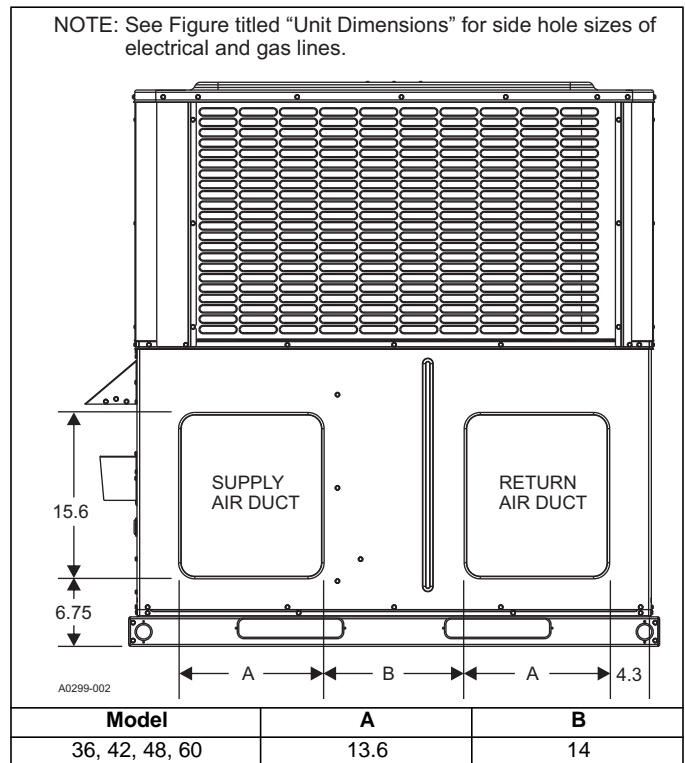

UNIT TYPICAL DUCT APPLICATIONS

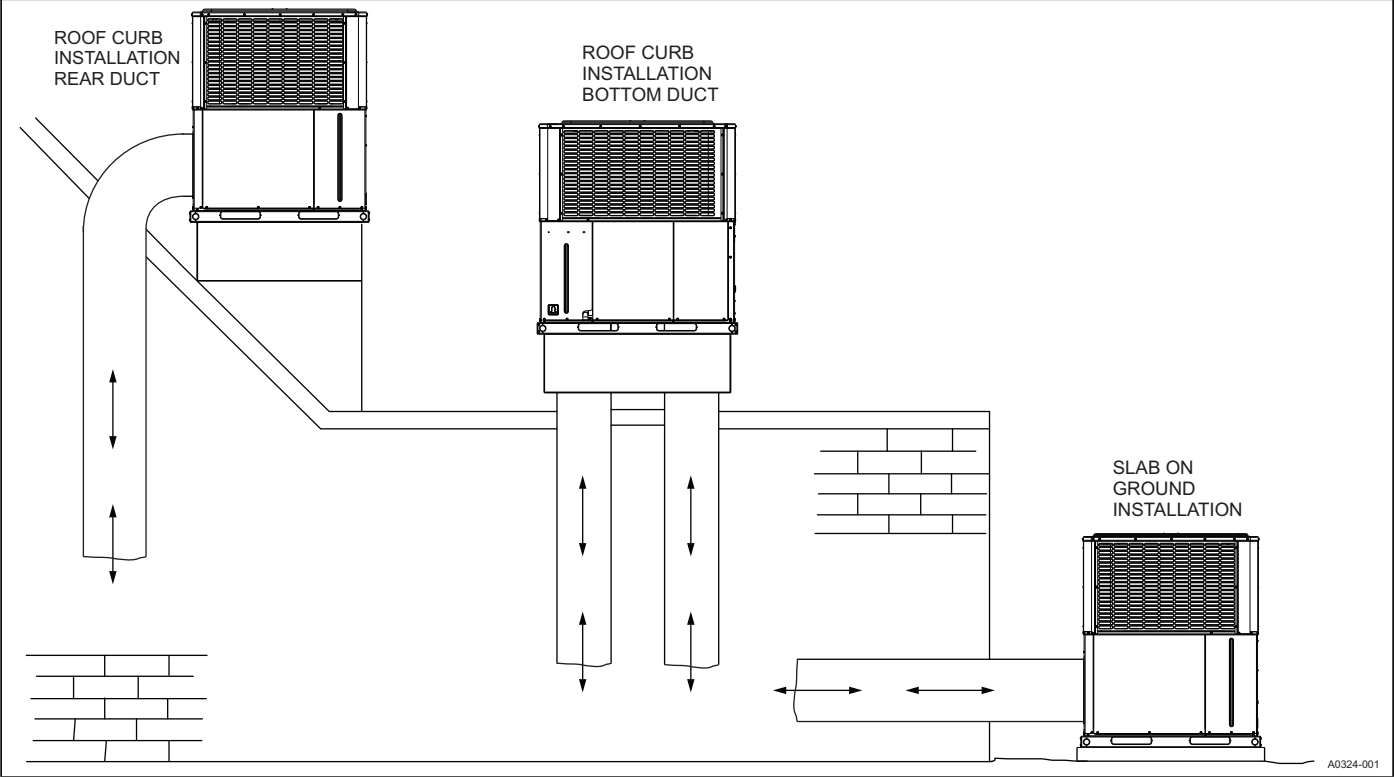

UNIT TYPICAL SLAB ON GROUND INSTALLATION

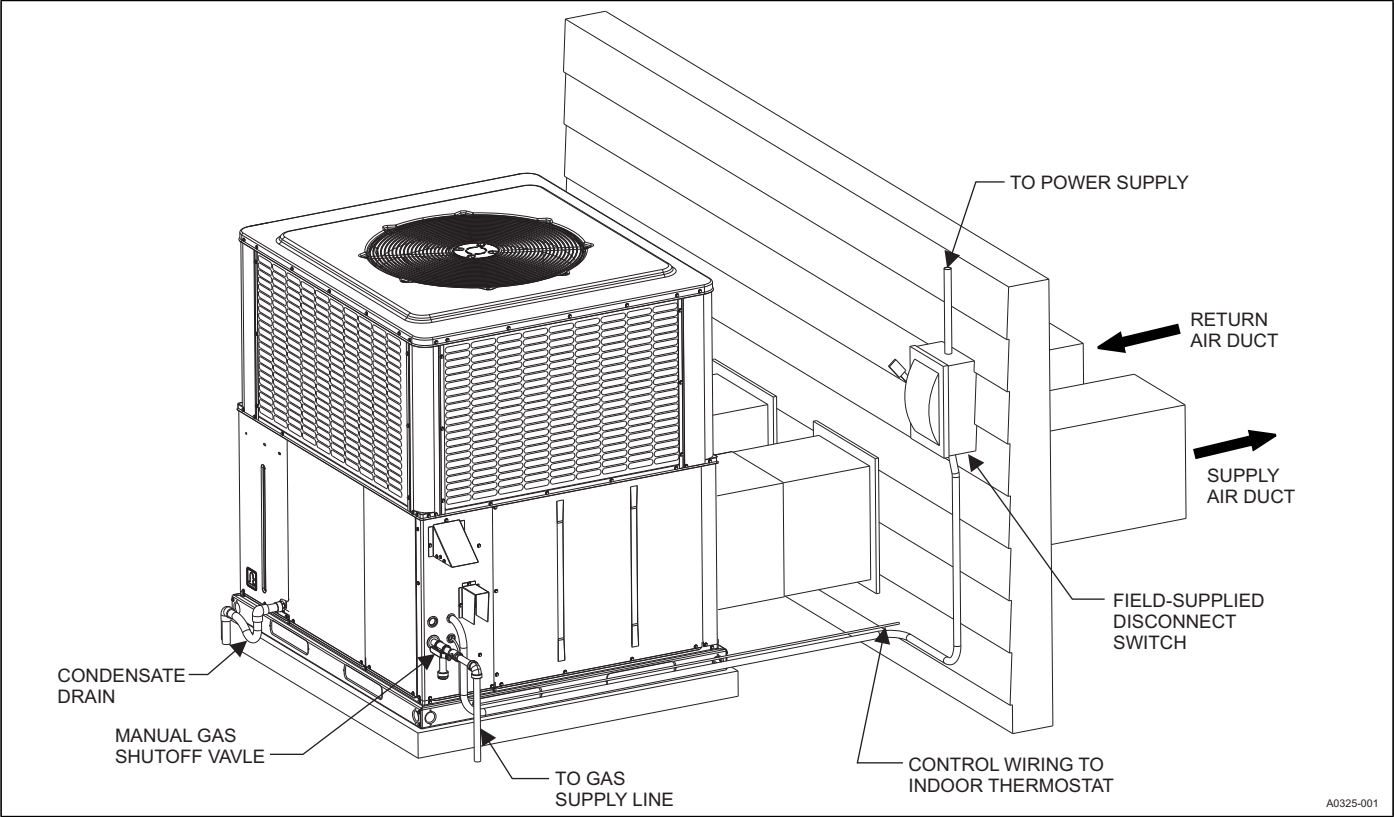

UNIT TYPICAL ROOF CURB INSTALLATION

