

SAMSUNG

VRF

Technical Data Book

**Max Heat DVM S2 for America
(R410A, 60Hz, HP)**



Model : AM***BXVTFH/AA, AM***BXVTJH/AA

History

Version	Modification	Date	Remark
Ver.1.0	Release Max Heat DVM S2 HP TDB for America	22.06.28	
Ver.2.0	Updated the Final Specification	22.08.04	
Ver.2.1	Updated the Design Procedure & Combination Ratio page	22.12.01	

Nomenclature

Outdoor Unit

Model Name

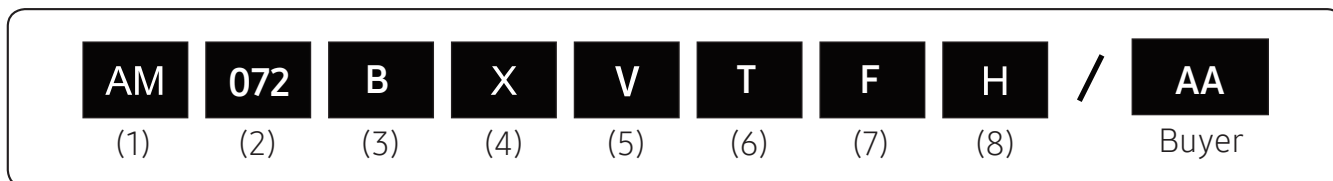

(1) Classification

AM	DVM
-----------	-----

(5) Feature 1

V	Inverter
----------	----------

(2) Capacity

kBtu/h (3 digits)

(6) Feature 2

A	Standard + General Temp.+ Module
H	High EER + Low Temp. + Module
G	High EER + General Temp. + Module
D	Standard + General Temp. + Non-Module
T	High EER+Low Temp.+ Module

(3) Version

B	2022
----------	------

(7) Rating Voltage

F	3Ø, 3#, 208~230V, 60Hz
J	3Ø, 3#, 460V, 60Hz

(4) Product Type

X	Outdoor Unit
N	Indoor Unit

(8) Mode

H	Heat Pump
R	Heat Recovery

Features & Benefits

Rebuilt on all new innovations

Rethink your approach to air conditioning with the Samsung DVM S2. It delivers outstanding comfort and energy efficiency, even in extreme climates. Its intelligent features make installation and maintenance easier and more cost-effective.



Perfectly compatible with WindFree™

Active Frequency Drive 10Hz

Enjoy continuous comfort and avoid wasting energy. Active Frequency Drive 10Hz technology enables the compressor to precisely control a small amount of refrigerant. So it maintains a more consistent temperature and is compatible with Samsung's WindFree™ Cooling.

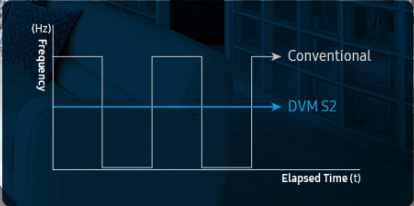

Features & Benefits

Enabling a new era of consistent comfort

Advanced Flash Injection Compressor

Enter a new era of non-stop comfort and efficiency. The Advanced Flash Injection Compressor provides the world's largest capacity*. It combines Flash Injection technology with a strengthened Triple Profile Scroll and efficient Optimal Discharge Superheat (DSH) Control technology.

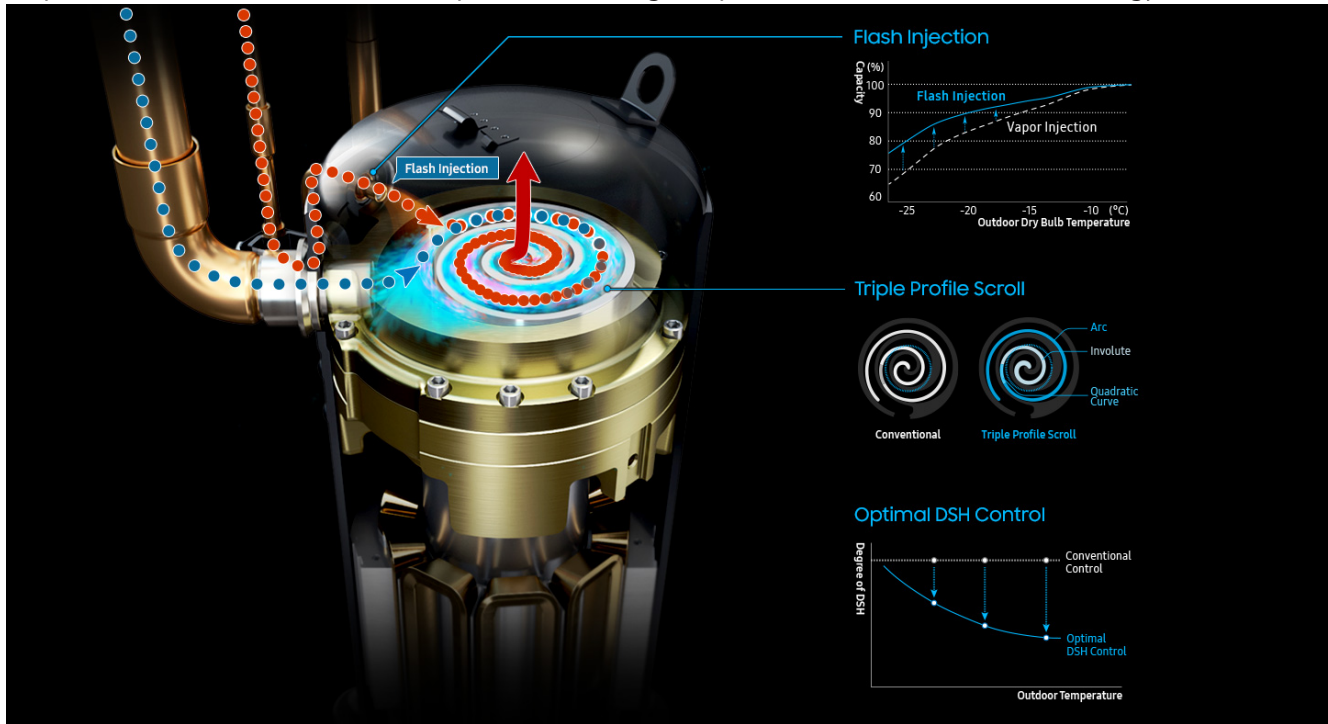

* Samsung circulates 14,400cc/sec refrigerant (= 90cc (displacement volume) x 160rps (revolutions per second)), while Company A circulates 12,480cc/sec (= 96cc x 130rps), Company B circulates 14,080cc/sec (= 88cc x 160rps) and Company C circulates 12,320cc/sec (= 88cc x 140rps).

Contents

1. Combination Table / Design Procedure & Combination Ratio	7
2. Specification	15
3. Electric Characteristics	35
4. Dimensional Drawing	36
5. Center of Gravity	37
6. Electrical Wiring Diagrams	38
7. Sound Data	40
8. Operation Range	44
9. Piping Diagram	46
10. Installation	47
11. AHRI Data	82

1. Combination Table : Outdoor units

DVM S2 HP (208~230V)

Capa (Ton)	Model name for combination	Number of Individual outdoor units	Combined outdoor units		
					
			072 (6Ton)	096 (8Ton)	120 (10Ton)
6	AM072BXVTFH/AA	1	1		
8	AM096BXVTFH/AA	1		1	
10	AM120BXVTFH/AA	1			1
12	AM144BXVTFH/AA	2	2		
14	AM168BXVTFH/AA	2	1	1	
16	AM192BXVTFH/AA	2	1		1
18	AM216BXVTFH/AA	2		1	1
20	AM240BXVTFH/AA	2			2
22	AM264BXVTFH/AA	3	2		1
24	AM288BXVTFH/AA	3	1	1	1
26	AM312BXVTFH/AA	3	1		2
28	AM336BXVTFH/AA	3		1	2
30	AM360BXVTFH/AA	3			3

NOTE

- Make sure to use an indoor unit that is compatible with DVM S2.
- Indoor units can be connected within the range indicated in following table.
- If the total capacity of the connected indoor units exceeds the indicated maximum capacity, cooling and heating capacity of the indoor unit may decrease.
- The standard allowed combination ratio of the total rated indoor unit capacity over the rated outdoor unit capacity is 50~130%.
Combination ratio of up to 184% is allowed depending on operation mode, minimum operation ratio and connected indoor unit models. DVM Pro 2 design software supports designing over 130% based on system design. Refer to the “Design Procedure & Combination Ratio” section of this document for details
- ※ You can connect maximum 64 indoor units to the outdoor unit. Maximum quantity of connectable indoor unit is set to 64 since outdoor unit only support up to 64 communication address. Indoor unit address can be assigned from 0~63. If the indoor unit address was assigned from 64~79, E201 error will occur.
- ※ Maximum 32 Wall-mount type indoor units with EEV (AM***NQG***, AM***NVD***) can be connected.

1. Combination Table : Outdoor units

DVM S2 HP (460V)

Capa (Ton)	Model name for combination	Number of Individual outdoor units	Combined outdoor units		
					
			072 (6Ton)	096 (8Ton)	120 (10Ton)
6	AM072BXVTJH/AA	1	1		
8	AM096BXVTJH/AA	1		1	
10	AM120BXVTJH/AA	1			1
12	AM144BXVTJH/AA	2	2		
14	AM168BXVTJH/AA	2	1	1	
16	AM192BXVTJH/AA	2	1		1
18	AM216BXVTJH/AA	2		1	1
20	AM240BXVTJH/AA	2			2
22	AM264BXVTJH/AA	3	2		1
24	AM288BXVTJH/AA	3	1	1	1
26	AM312BXVTJH/AA	3	1		2
28	AM336BXVTJH/AA	3		1	2
30	AM360BXVTJH/AA	3			3



NOTE

- Make sure to use an indoor unit that is compatible with DVM S2.
- Indoor units can be connected within the range indicated in following table.
- If the total capacity of the connected indoor units exceeds the indicated maximum capacity, cooling and heating capacity of the indoor unit may decrease.
- The standard allowed combination ratio of the total rated indoor unit capacity over the rated outdoor unit capacity is 50~130%.
Combination ratio of up to 184% is allowed depending on operation mode, minimum operation ratio and connected indoor unit models. DVM Pro 2 design software supports designing over 130% based on system design. Refer to the “Design Procedure & Combination Ratio” section of this document for details
- ※ You can connect maximum 64 indoor units to the outdoor unit. Maximum quantity of connectable indoor unit is set to 64 since outdoor unit only support up to 64 communication address. Indoor unit address can be assigned from 0~63. If the indoor unit address was assigned from 64~79, E201 error will occur.
- ※ Maximum 32 Wall-mount type indoor units with EEV (AM***NQD***, AM***NVD***) can be connected.

1. Combination Table : Outdoor units

External Appearance



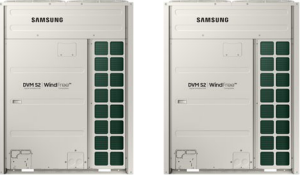

DVM S2 HP (208~230V)

Capa [TON]	Model Name	Model	Capa [TON]	Model Name	Model
6	AM072BXVTFH/AA		22	AM264BXVTFH/AA	
8	AM096BXVTFH/AA				
10	AM120BXVTFH/AA				
12	AM144BXVTFH/AA		24	AM288BXVTFH/AA	
14	AM168BXVTFH/AA				
16	AM192BXVTFH/AA				
18	AM216BXVTFH/AA				
20	AM240BXVTFH/AA				

1. Combination Table : Outdoor units

External Appearance

DVM S2 HP (460V)

Capa [TON]	Model Name	Model	Capa [TON]	Model Name	Model
6	AM072BXVTJH/AA		22	AM264BXVTJH/AA	
8	AM096BXVTJH/AA				
10	AM120BXVTJH/AA				
12	AM144BXVTJH/AA		24	AM288BXVTJH/AA	
14	AM168BXVTJH/AA				
16	AM192BXVTJH/AA				
18	AM216BXVTJH/AA				
20	AM240BXVTJH/AA				
			26	AM312BXVTJH/AA	
			28	AM336BXVTJH/AA	
			30	AM360BXVTJH/AA	

Design Procedure & Combination Ratio

Combination Ratio (Connection Ratio)

Definition of Combination Ratio, CR

$$CR = \frac{\text{Sum of Nominal Cooling Capacity of Indoor units}}{\text{Nominal Cooling Capacity of Outdoor unit}} * 100\%$$

Constraints of Allowable Combination Ratio

DVM S systems are normally designed to utilize a CR 50% to 130% to ensure effective load balancing between indoor units and outdoor unit. As buildings have become more insulated, and usage and occupancy of buildings are highly variable, more buildings can realize a higher load balancing between IDUs and ODU, thus higher CR (>130%) is often required. If a system design exceeds 130%, risks associated to increased indoor sound level and reduced comfort levels should be considered. Therefore, when it is necessary to design a combination ratio exceeding 130%, the following conditions must be complied with: -

Design & Selection Procedure

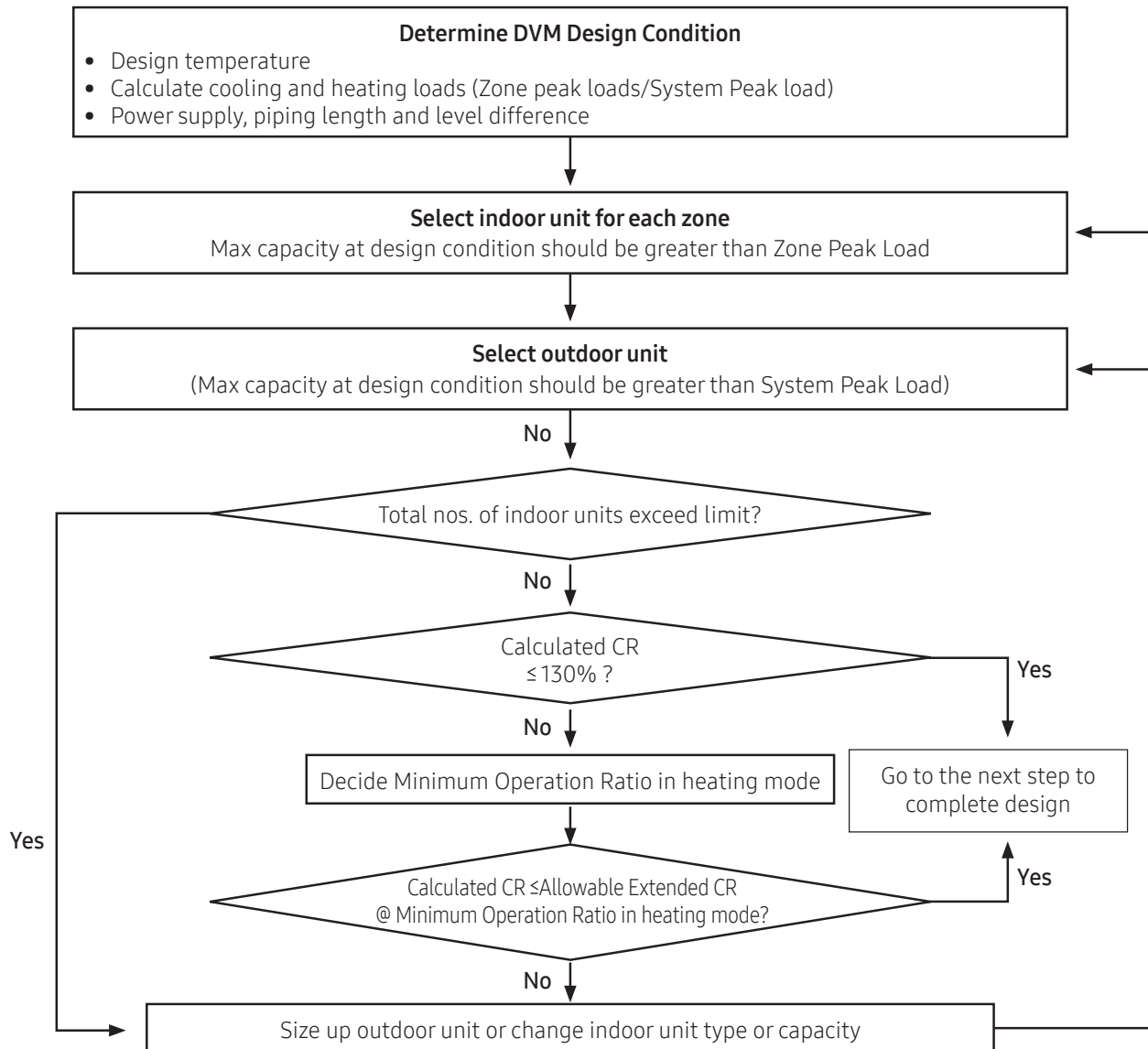

Fig. 1 Design & Selection Procedure for Extended Combination Ratio

Design Procedure & Combination Ratio

Combination Ratio (Connection Ratio)

Satisfying cooling & heating comfort

The Maximum Capacity of outdoor unit at design condition calculated from Samsung capacity data table or design tool (DVM Pro) should always be the same or greater than System Peak Load (Block Load) defined in table 1.

Time	Room A	Room B	Room C	Room D	Room E	Room F	Total
	Music Room	Class room	Class room	Class room	Class room	Class room	
09:00	8.4	8.0	8.4	8.0	8.4	8.6	49.8
12:00	9.2	8.8	10.8	8.6	10.8	9.8	58.0
14:00	10.0	9.6	9.6	9.6	11.4	10.8	61.0
16:00	11.0	10.6	8.8	10.8	9.6	9.6	60.4
18:00	9.4	9.0	8.8	9.0	9.0	8.4	53.6

Table 1. Example of System Peak loads

- ▶ Zone Peak Loads (■): To satisfy the demand for each room any time
 - Sum of Zone peak Loads = 65.4kW (11.0 + 10.6 + 10.8 + 10.8 + 11.4 + 10.8)
- ▶ Block load (■): Total peak load at a given time of day.
 - Sum of Zone Peak Loads at 14:00 = 61.0kW



- When a system combination ratio is over 130%, a max system capacity is the same as the published capacity in TDB capacity table at the combination ratio of 130%

Cooling Operation Only

When only cooling operation is used, CR is allowed up to 180% if the Max Capacity of outdoor unit is greater than System Peak Load (Block load) as shown table 2.

Outdoor unit	All capacities of H/P & H/R model
Indoor unit	All indoor unit types
Operation Condition	Cooling mode only
Allowable CR	180%

Table 2. Allowable CR in only cooling operation



- Table 2 shows a standard for allowable CR of cooling only model. Samsung Electronics is not responsible for any problem caused by using a heating mode at the site with a system designed by table 2. If heating operation is required, extended CR design must follow section "Allowable CR limit to avoid abnormal sound level risks in heating operation."

Design Procedure & Combination Ratio

Combination Ratio (Connection Ratio)

Allowable CR limit to avoid abnormal sound level risks in heating operation

- ▶ If the CR exceeds 130%, in a specific case of heating operation, an indoor unit may have higher sound level than the level specified in the technical documents.
- ▶ In order to minimize the sound level, the system minimum operation ratio needs to be verified and considered as follows:

※ Operation Ratio(%), OR

- Heat Pump system, H/P

$$OR_{(H/P)} (\%) = \frac{\text{Sum of nominal capacity of indoor units running in heating mode}}{\text{Sum of nominal capacity of indoor units}} * 100\%$$

- Heat Recovery system, H/R

$$OR_{(H/R)} (\%) = \frac{\text{Sum of nominal capacity of indoor units running in both cooling & heating mode}}{\text{Sum of nominal capacity of indoor units}} * 100\%$$

The Minimum Operation Ratio should be determined during the project design stage using Fig. 2.

Outdoor unit	All capacities of H/P & H/R (Single, Dual and Triple Module Systems)		
Indoor unit	All indoor unit types ^{*)} except Wall-Mounted		Wall-Mounted
Operation Ratio	Nominal Capacity ≤ 18kBtu/h	Nominal capacity > 18kBtu/h	All capacities
10%	150%	158%	141%
20%	161%	170%	155%
30%	171%	184%	173%

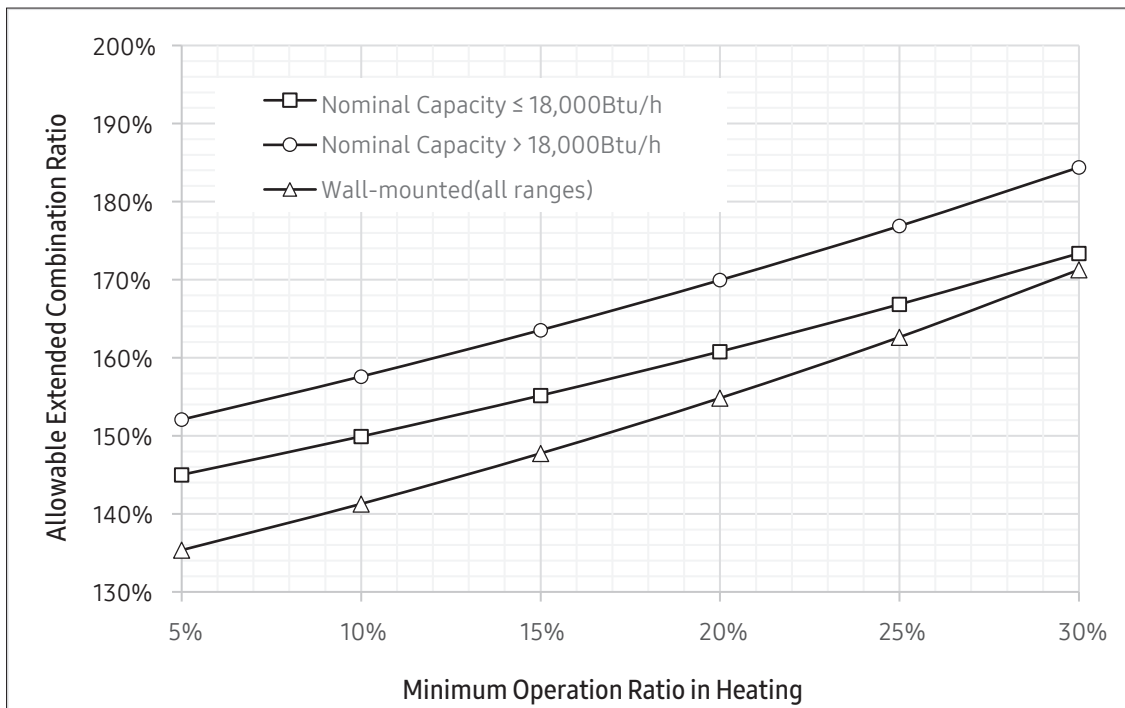

Fig. 2 Allowable CR with respect to indoor unit type as operation ratio increases

Design Procedure & Combination Ratio

Combination Ratio (Connection Ratio)

- The minimum operation ratio should be considered during the design stage.
- If a system has a mix of unit types or capacity, the lowest extended connection ratio curve must be utilized.
- In case that a designed Minimum Operation Ratio is less than 5% or more than 30%, the Allowable Extended CR must be considered as the value at 5% and 30%, respectively.
- *If one of following indoor unit types is included in a system, the CR cannot be extended beyond 130%.

Type of indoor unit	Limited by CR130%
1Way Cassette / 4Way Cassette (600 x 600)	9kBtu/h or below
360 Cassette / Slim Duct (LSP duct)	12kBtu/h or below
4Way Cassette	18kBtu/h or below
Floor Standing (Exposed or Concealed)	18kBtu/h only
Ceiling Suspended	24kBtu/h only
Hydro unit (HE/HT)	All capacities



NOTE

- Samsung is not responsible for any issue, including abnormal noise that arises during heating operation due solely to the operation rate being lower than the designated combination ratio shown in Fig. 2. Please contact your local Samsung representative for further details if the project requires you to design the project with a connection ratio greater than 130%.

2. Specification

DVM S2 (208~230V)

Model Name				AM072BXVTFH/AA	AM096BXVTFH/AA	AM120BXVTFH/AA
Outdoor unit module 1				-	-	-
Outdoor unit module 2				-	-	-
Outdoor unit module 3				-	-	-
Outdoor unit module 4				-	-	-
Power Supply			Ø, #, V, Hz	3, 3, 208~230, 60	3, 3, 208~230, 60	3, 3, 208~230, 60
Mode			-	Heat Pump	Heat Pump	Heat Pump
Performance			TON	6	8	10
Capacity (Nominal)		Cooling	Btu/h	72,000	96,000	120,000
		Heating	Btu/h	81,000	108,000	135,000
Capacity (Rated)		Cooling	Btu/h	69,000	92,000	114,000
		Heating	Btu/h	77,000	103,000	129,000
Maximum number of connectable indoor units			EA	12	16	20
Total capacity of the connected Indoor Units		Min.	Btu/h	36,000	48,000	60,000
		Max.	Btu/h	93,600	124,800	156,000
Power	Current	MCA	A	50.0	62.0	76.0
		MOP	A	60	70	90
Casing	Material	Body	-	GI Steel Plate	GI Steel Plate	GI Steel Plate
		Base	-	GI Steel Plate	GI Steel Plate	GI Steel Plate
Heat Exchanger	Type		-	Fin & Tube	Fin & Tube	Fin & Tube
	Material	Fin	-	Al	Al	Al
		Tube	-	Cu	Cu	Cu
Fin Treatment		-		Anti-corrosion	Anti-corrosion	Anti-corrosion
Compressor	Type		-	Inverter Scroll x 2	Inverter Scroll x 2	Inverter Scroll x 2
	Output		kW x n	4.39 x 2	6.45 x 2	6.45 x 2
	Model Name		-	DS2GT7046EV* x 2	DS4GT5066EV* x 2	DS4GT5066EV* x 2
	Oil	Type	-	PVE	PVE	PVE
		Initial charge	cc x n	900 x 2	1,100 x 2	1,100 x 2
		fl oz x n	30.4 x 2	37.2 x 2	37.2 x 2	
Fan	Type		-	Propeller	Propeller	Propeller
	Discharge direction		-	Top	Top	Top
	Quantity		EA	2	2	2
	Air Flow Rate		CFM (m ³ /min)	9,924 (281)	9,571 (271)	10,171 (288)
	External Static Pressure	Max.	mmAq	11	11	11
			Pa	110	110	110
		in Wg (Pa)	0.43 (107.87)	0.43 (107.87)	0.43 (107.87)	
Fan Motor	Type		-	BLDC Motor	BLDC Motor	BLDC Motor
	Output		W x n	620 x 2	620 x 2	620 x 2
Piping Connections	Liquid Pipe		Type	Braze connection	Braze connection	Braze connection
			Φ, inch (mm)	3/8 (9.52)	3/8 (9.52)	1/2 (12.70)
	Gas Pipe		Type	Braze connection	Braze connection	Braze connection
			Φ, inch (mm)	3/4 (19.05)	7/8 (22.22)	1-1/8 (28.58)
	Heat Insulation		-	Both liquid and gas pipes	Both liquid and gas pipes	Both liquid and gas pipes
	Piping length (ODU-IDU)	Max. [Equiv.]	ft	656 [722]	656 [722]	656 [722]
	Piping length (1st Branch-IDU)	Max.	ft	295	295	295
	Total piping length (System)	Max.	ft	3,281	3,281	3,281
	Level difference (ODU in highest position)	Max.	ft	361	361	361
	Level difference (IDU in highest position)	Max.	ft	361	361	361
Level difference (IDU-IDU)	Max.	ft	164	164	164	

2. Specification

DVM S2 (208~230V)

Model Name				AM072BXVTFH/AA	AM096BXVTFH/AA	AM120BXVTFH/AA	
Outdoor unit module 1				-	-	-	
Outdoor unit module 2				-	-	-	
Outdoor unit module 3				-	-	-	
Outdoor unit module 4				-	-	-	
Wiring Connections	Transmission Cable	Min.	mm ²	0.75	0.75	0.75	
		Remark	-	F1, F2	F1, F2	F1, F2	
	Power supply intake			-	Both indoor and outdoor unit	Both indoor and outdoor unit	Both indoor and outdoor unit
Refrigerant	Type		-	R410A	R410A	R410A	
	Factory Charging		lbs (kg)	17.6 (8.0)	23.1 (10.5)	23.1 (10.5)	
Sound	Sound Pressure	Cooling	dB(A)	55.0	57.0	59.0	
		Heating	dB(A)	56.0	58.0	59.0	
	Sound Power		dB(A)	74.0	77.0	79.0	
External Dimension	Net Weight		lbs (kg)	553 (251)	644 (292)	644 (292)	
	Shipping Weight		lbs (kg)	591 (268)	681 (309)	681 (309)	
	Net Dimensions (WxHxD)			mm	1,295 x 1,695 x 765	1,295 x 1,695 x 765	1,295 x 1,695 x 765
				inch	51 x 66-3/4 x 30-1/8	51 x 66-3/4 x 30-1/8	51 x 66-3/4 x 30-1/8
	Shipping Dimensions (WxHxD)			mm	1,363 x 1,887 x 829	1,363 x 1,887 x 829	1,363 x 1,887 x 829
				inch	53-11/16 x 74-5/16 x 32-11/16	53-11/16 x 74-5/16 x 32-11/16	53-11/16 x 74-5/16 x 32-11/16
Operating Temp. Range	Cooling		°F (°C)	5 ~ 122 (-15 ~ 50)	5 ~ 122 (-15 ~ 50)	5 ~ 122 (-15 ~ 50)	
	Heating		°F (°C)	-22 ~ 75 (-30 ~ 24)	-22 ~ 75 (-30 ~ 24)	-22 ~ 75 (-30 ~ 24)	

NOTE

- Specification may be subject to change without prior notice.
 - Specification comply with EN14511.
- Nominal capacities are based on (Equivalent refrigerant piping : 25ft, Level differences : 0ft);
 - Cooling : Indoor temperature 80°F DB, 67°F WB / Outdoor temperature 95°F DB, 75°F WB
 - Heating : Indoor temperature 70°F DB, 60°F WB / Outdoor temperature 47°F DB, 43°F WB
 - The standard allowed combination ratio of the total rated indoor unit capacity over the rated outdoor unit capacity is 50~130%. Combination ratio of up to 184% is allowed depending on operation mode, minimum operation ratio and connected indoor unit models. DVM Pro 2 design software supports designing over 130% based on system design. Refer to the "Design Procedure & Combination Ratio" section of this document for details
 - If outdoor unit is located in a higher position than indoor unit, level difference is 361ft or under.
 - (If the level difference is higher than 164ft, the PDM kit should be installed)
 - *PDM kit: Pressure Drop Modulation kit
 - These products contain R410A which is fluorinated greenhouse gas.
 - Sound pressure was acquired in a dead room. Thus actual noise level may be different depending on the installation conditions.
 - Sound power level is an absolute value that a sound source generates.
 - Sound pressure level is a relative value, depending on the distance and acoustic environment.
 - Sound values are obtained in an anechoic room.
 - Sound values of multi combination are theoretical values based on sound results of individual installed units.
 - Cooling operation is possible at -15°C(5°F) or higher if satisfied following conditions.
 - (If the outdoor temperature below -5°C(23°F), wind(snow) protection duct must be installed on the suction side of the heat exchanger and at least 50%capacity of the connected indoor units must be operated.) However, if the outdoor unit is installed below the indoor unit, cooling operation is possible only at -5°C(23°F) or higher.
 - External static pressure of the model installed as a combined module follows the external static pressure of each single unit.
- For more information regarding capacity correction, please refer to capacity tables available at www.SamsungHVAC.com/downloads.

2. Specification

DVM S2 (208~230V)

Model Name				AM144BXVTFH/AA	AM168BXVTFH/AA	AM192BXVTFH/AA	
Outdoor unit module 1				AM072BXVTFH/AA	AM072BXVTFH/AA	AM072BXVTFH/AA	
Outdoor unit module 2				AM072BXVTFH/AA	AM096BXVTFH/AA	AM120BXVTFH/AA	
Outdoor unit module 3				-	-	-	
Outdoor unit module 4				-	-	-	
Power Supply			Ø, #, V, Hz	3, 3, 208~230, 60	3, 3, 208~230, 60	3, 3, 208~230, 60	
Mode			-	Heat Pump	Heat Pump	Heat Pump	
Performance			TON	12	14	16	
Capacity (Nominal)		Cooling	Btu/h	144,000	168,000	192,000	
		Heating	Btu/h	162,000	189,000	216,000	
Capacity (Rated)		Cooling	Btu/h	138,000	160,000	182,000	
		Heating	Btu/h	154,000	180,000	206,000	
Maximum number of connectable indoor units			EA	25	29	33	
Total capacity of the connected Indoor Units		Min.	Btu/h	72,000	84,000	96,000	
		Max.	Btu/h	187,200	218,400	249,600	
Power		Current		MCA	A	-	
		MOP		A	-	-	
Casing		Material		Body	-	GI Steel Plate	
		Base		-	GI Steel Plate	GI Steel Plate	
Heat Exchanger		Type		-	Fin & Tube	Fin & Tube	
		Material		Fin	-	Al	Al
				Tube	-	Cu	Cu
Fin Treatment		-		Anti-corrosion	Anti-corrosion	Anti-corrosion	
Compressor		Type		-	Inverter Scroll x 4	Inverter Scroll x 4	
		Output		kW x n	(4.39 x 2) x 2	(4.39 x 2) x 1 + (6.45 x 2) x 1	(4.39 x 2) x 1 + (6.45 x 2) x 1
		Model Name		-	(DS2GT7046EV* x 2) x 2	(DS2GT7046EV* x 2) x 1 + (DS4GT5066EV* x 2) x 1	(DS2GT7046EV* x 2) x 1 + (DS4GT5066EV* x 2) x 1
		Oil		Type	-	PVE	PVE
				Initial charge	cc x n	(900 x 2) x 2	(900 x 2) x 1 + (1,100 x 2) x 1
			fl oz x n	(30.4 x 2) x 2	(30.4 x 2) x 1 + (37.2 x 2) x 1	(30.4 x 2) x 1 + (37.2 x 2) x 1	
Fan		Type		-	Propeller	Propeller	
		Discharge direction		-	Top	Top	
		Quantity		EA	4	4	4
		Air Flow Rate		CFM (m ³ /min)	9,924 x 2 (281 x 2)	9,924 x 1 + 9,571 x 1 (281 x 1 + 271 x 1)	9,924 x 1 + 10,171 x 1 (281 x 1 + 288 x 1)
		External Static Pressure		Max.	mmAq	-	-
					Pa	-	-
			in Wg (Pa)	-	-		
Fan Motor		Type		-	BLDC Motor	BLDC Motor	
		Output		W x n	(620 x 2) x 2	(620 x 2) x 2	(620 x 2) x 2
Piping Connections		Liquid Pipe		Type	Braze connection	Braze connection	
				Φ, inch (mm)	1/2 (12.70)	5/8 (15.88)	
		Gas Pipe		Type	Braze connection	Braze connection	
				Φ, inch (mm)	1-1/8 (28.58)	1-1/8 (28.58)	
		Heat Insulation		-	Both liquid and gas pipes	Both liquid and gas pipes	
		Piping length (ODU-IDU)	Max. [Equiv.]	ft	656 [722]	656 [722]	
		Piping length (1st Branch-IDU)	Max.	ft	295	295	
		Total piping length (System)	Max.	ft	3,281	3,281	
Level difference (ODU in highest position)	Max.	ft	361	361			
Level difference (IDU in highest position)	Max.	ft	361	361			
Level difference (IDU-IDU)	Max.	ft	164	164			

2. Specification

DVM S2 (208~230V)

Model Name				AM144BXVTFH/AA	AM168BXVTFH/AA	AM192BXVTFH/AA	
Outdoor unit module 1				AM072BXVTFH/AA	AM072BXVTFH/AA	AM072BXVTFH/AA	
Outdoor unit module 2				AM072BXVTFH/AA	AM096BXVTFH/AA	AM120BXVTFH/AA	
Outdoor unit module 3				-	-	-	
Outdoor unit module 4				-	-	-	
Wiring Connections	Transmission Cable	Min.	mm ²	0.75	0.75	0.75	
		Remark	-	F1, F2	F1, F2	F1, F2	
	Power supply intake			-	Both indoor and outdoor unit	Both indoor and outdoor unit	Both indoor and outdoor unit
Refrigerant	Type		-	R410A	R410A	R410A	
	Factory Charging		lbs (kg)	17.6 x 2 (8.0 x 2)	17.6 x 1 + 23.1 x 1 (8.0 x 1 + 10.5 x 1)	17.6 x 1 + 23.1 x 1 (8.0 x 1 + 10.5 x 1)	
Sound	Sound Pressure	Cooling	dB(A)	58.0	59.1	60.5	
		Heating	dB(A)	59.0	60.1	60.8	
	Sound Power		dB(A)	77.0	78.8	80.2	
External Dimension	Net Weight		lbs (kg)	553 x 2 (251 x 2)	553 x 1 + 644 x 1 (251 x 1 + 292 x 1)	553 x 1 + 644 x 1 (251 x 1 + 292 x 1)	
	Shipping Weight		lbs (kg)	591 x 2 (268 x 2)	591 x 1 + 681 x 1 (268 x 1 + 309 x 1)	591 x 1 + 681 x 1 (268 x 1 + 309 x 1)	
	Net Dimensions (WxHxD)			mm	(1,295 x 1,695 x 765) x 2	(1,295 x 1,695 x 765) x 2	(1,295 x 1,695 x 765) x 2
				inch	(51 x 66-3/4 x 30-1/8) x 2	(51 x 66-3/4 x 30-1/8) x 2	(51 x 66-3/4 x 30-1/8) x 2
	Shipping Dimensions (WxHxD)			mm	(1,363 x 1,887 x 829) x 2	(1,363 x 1,887 x 829) x 2	(1,363 x 1,887 x 829) x 2
				inch	(53-11/16 x 74-5/16 x 32-11/16) x 2	(53-11/16 x 74-5/16 x 32-11/16) x 2	(53-11/16 x 74-5/16 x 32-11/16) x 2
Operating Temp. Range	Cooling		°F (°C)	5 ~ 122 (-15 ~ 50)	5 ~ 122 (-15 ~ 50)	5 ~ 122 (-15 ~ 50)	
	Heating		°F (°C)	-22 ~ 75 (-30 ~ 24)	-22 ~ 75 (-30 ~ 24)	-22 ~ 75 (-30 ~ 24)	

NOTE

- Specification may be subject to change without prior notice.
 - Specification comply with EN14511.
- Nominal capacities are based on (Equivalent refrigerant piping : 25ft, Level differences : 0ft);
 - Cooling : Indoor temperature 80°F DB, 67°F WB / Outdoor temperature 95°F DB, 75°F WB
 - Heating : Indoor temperature 70°F DB, 60°F WB / Outdoor temperature 47°F DB, 43°F WB
 - The standard allowed combination ratio of the total rated indoor unit capacity over the rated outdoor unit capacity is 50~130%. Combination ratio of up to 184% is allowed depending on operation mode, minimum operation ratio and connected indoor unit models. DVM Pro 2 design software supports designing over 130% based on system design. Refer to the "Design Procedure & Combination Ratio" section of this document for details
 - If outdoor unit is located in a higher position than indoor unit, level difference is 361ft or under.
 - (If the level difference is higher than 164ft, the PDM kit should be installed)
 - *PDM kit: Pressure Drop Modulation kit
 - These products contain R410A which is fluorinated greenhouse gas.
 - Sound pressure was acquired in a dead room. Thus actual noise level may be different depending on the installation conditions.
 - Sound power level is an absolute value that a sound source generates.
 - Sound pressure level is a relative value, depending on the distance and acoustic environment.
 - Sound values are obtained in an anechoic room.
 - Sound values of multi combination are theoretical values based on sound results of individual installed units.
 - Cooling operation is possible at -15°C(5°F) or higher if satisfied following conditions.
 - (If the outdoor temperature below -5°C(23°F), wind(snow) protection duct must be installed on the suction side of the heat exchanger and at least 50%capacity of the connected indoor units must be operated.) However, if the outdoor unit is installed below the indoor unit, cooling operation is possible only at -5°C(23°F) or higher.
 - External static pressure of the model installed as a combined module follows the external static pressure of each single unit.
- For more information regarding capacity correction, please refer to capacity tables available at www.SamsungHVAC.com/downloads.

2. Specification

DVM S2 (208~230V)

Model Name				AM216BXVTFH/AA	AM240BXVTFH/AA	AM264BXVTFH/AA
Outdoor unit module 1				AM096BXVTFH/AA	AM120BXVTFH/AA	AM072BXVTFH/AA
Outdoor unit module 2				AM120BXVTFH/AA	AM120BXVTFH/AA	AM072BXVTFH/AA
Outdoor unit module 3				-	-	AM120BXVTFH/AA
Outdoor unit module 4				-	-	-
Power Supply			Ø, #, V, Hz	3, 3, 208~230, 60	3, 3, 208~230, 60	3, 3, 208~230, 60
Mode			-	Heat Pump	Heat Pump	Heat Pump
Performance	TON		TON	18	20	22
	Capacity (Nominal)	Cooling	Btu/h	216,000	240,000	264,000
		Heating	Btu/h	243,000	270,000	297,000
	Capacity (Rated)	Cooling	Btu/h	206,000	228,000	252,000
Heating		Btu/h	232,000	258,000	282,000	
Maximum number of connectable indoor units			EA	37	41	45
Total capacity of the connected Indoor Units		Min.	Btu/h	108,000	120,000	132,000
		Max.	Btu/h	280,800	312,000	343,200
Power	Current	MCA	A	-	-	-
		MOP	A	-	-	-
Casing	Material	Body	-	GI Steel Plate	GI Steel Plate	GI Steel Plate
		Base	-	GI Steel Plate	GI Steel Plate	GI Steel Plate
Heat Exchanger	Type		-	Fin & Tube	Fin & Tube	Fin & Tube
	Material	Fin	-	Al	Al	Al
		Tube	-	Cu	Cu	Cu
	Fin Treatment		-	Anti-corrosion	Anti-corrosion	Anti-corrosion
Compressor	Type		-	Inverter Scroll x 4	Inverter Scroll x 4	Inverter Scroll x 6
	Output		kW x n	(6.45 x 2) x 2	(6.45 x 2) x 2	(4.39 x 2) x 2 + (6.45 x 2) x 1
	Model Name		-	(DS4GT5066EV* x 2) x 2	(DS4GT5066EV* x 2) x 2	(DS2GT7046EV* x 2) x 2 + (DS4GT5066EV* x 2) x 1
	Oil	Type	-	PVE	PVE	PVE
		Initial charge	cc x n	(1,100 x 2) x 2	(1,100 x 2) x 2	(900 x 2) x 2 + (1,100 x 2) x 1
		fl oz x n	(37.2 x 2) x 2	(37.2 x 2) x 2	(30.4 x 2) x 2 + (37.2 x 2) x 1	
Fan	Type		-	Propeller	Propeller	Propeller
	Discharge direction		-	Top	Top	Top
	Quantity		EA	4	4	6
	Air Flow Rate		CFM (m ³ /min)	9,571 x 1 + 10,171 x 1 (271 x 1 + 288 x 1)	10,171 x 2 (288 x 2)	9,924 x 2 + 10,171 x 1 (281 x 2 + 288 x 1)
	External Static Pressure	Max.	mmAq	-	-	-
			Pa	-	-	-
		in Wg (Pa)	-	-	-	
Fan Motor	Type		-	BLDC Motor	BLDC Motor	BLDC Motor
	Output		W x n	(620 x 2) x 2	(620 x 2) x 2	(620 x 2) x 3
Piping Connections	Liquid Pipe		Type	Braze connection	Braze connection	Braze connection
			Φ, inch (mm)	5/8 (15.88)	5/8 (15.88)	3/4 (19.05)
	Gas Pipe		Type	Braze connection	Braze connection	Braze connection
			Φ, inch (mm)	1-1/8 (28.58)	1-3/8 (34.92)	1-3/8 (34.92)
	Heat Insulation		-	Both liquid and gas pipes	Both liquid and gas pipes	Both liquid and gas pipes
	Piping length (ODU-IDU)	Max. [Equiv.]	ft	656 [722]	656 [722]	656 [722]
	Piping length (1st Branch-IDU)	Max.	ft	295	295	295
	Total piping length (System)	Max.	ft	3,281	3,281	3,281
	Level difference (ODU in highest position)	Max.	ft	361	361	361
	Level difference (IDU in highest position)	Max.	ft	361	361	361
Level difference (IDU-IDU)	Max.	ft	164	164	164	

2. Specification

DVM S2 (208~230V)

Model Name				AM216BXVTFH/AA	AM240BXVTFH/AA	AM264BXVTFH/AA	
Outdoor unit module 1				AM096BXVTFH/AA	AM120BXVTFH/AA	AM072BXVTFH/AA	
Outdoor unit module 2				AM120BXVTFH/AA	AM120BXVTFH/AA	AM072BXVTFH/AA	
Outdoor unit module 3				-	-	AM120BXVTFH/AA	
Outdoor unit module 4				-	-	-	
Wiring Connections	Transmission Cable	Min.	mm ²	0.75	0.75	0.75	
		Remark	-	F1, F2	F1, F2	F1, F2	
	Power supply intake			-	Both indoor and outdoor unit	Both indoor and outdoor unit	Both indoor and outdoor unit
Refrigerant	Type		-	R410A	R410A	R410A	
	Factory Charging		lbs (kg)	23.1 x 2 (10.5 x 2)	23.1 x 2 (10.5 x 2)	17.6 x 2 + 23.1 x 1 (8.0 x 2 + 10.5 x 1)	
Sound	Sound Pressure	Cooling	dB(A)	61.1	62.0	61.5	
		Heating	dB(A)	61.5	62.0	62.0	
	Sound Power		dB(A)	81.1	82.0	81.1	
External Dimension	Net Weight		lbs (kg)	644 x 2 (292 x 2)	644 x 2 (292 x 2)	553 x 2 + 644 x 1 (251 x 2 + 292 x 1)	
	Shipping Weight		lbs (kg)	681 x 2 (309 x 2)	681 x 2 (309 x 2)	591 x 2 + 681 x 1 (268 x 2 + 309 x 1)	
	Net Dimensions (WxHxD)			mm	(1,295 x 1,695 x 765) x 2	(1,295 x 1,695 x 765) x 2	(1,295 x 1,695 x 765) x 3
				inch	(51 x 66-3/4 x 30-1/8) x 2	(51 x 66-3/4 x 30-1/8) x 2	(51 x 66-3/4 x 30-1/8) x 3
	Shipping Dimensions (WxHxD)			mm	(1,363 x 1,887 x 829) x 2	(1,363 x 1,887 x 829) x 2	(1,363 x 1,887 x 829) x 3
				inch	(53-11/16 x 74-5/16 x 32-11/16) x 2	(53-11/16 x 74-5/16 x 32-11/16) x 2	(53-11/16 x 74-5/16 x 32-11/16) x 3
Operating Temp. Range	Cooling		°F (°C)	5 ~ 122 (-15 ~ 50)	5 ~ 122 (-15 ~ 50)	5 ~ 122 (-15 ~ 50)	
	Heating		°F (°C)	-22 ~ 75 (-30 ~ 24)	-22 ~ 75 (-30 ~ 24)	-22 ~ 75 (-30 ~ 24)	

NOTE

- Specification may be subject to change without prior notice.
 - Specification comply with EN14511.
- Nominal capacities are based on (Equivalent refrigerant piping : 25ft, Level differences : 0ft);
 - Cooling : Indoor temperature 80°F DB, 67°F WB / Outdoor temperature 95°F DB, 75°F WB
 - Heating : Indoor temperature 70°F DB, 60°F WB / Outdoor temperature 47°F DB, 43°F WB
 - The standard allowed combination ratio of the total rated indoor unit capacity over the rated outdoor unit capacity is 50~130%. Combination ratio of up to 184% is allowed depending on operation mode, minimum operation ratio and connected indoor unit models. DVM Pro 2 design software supports designing over 130% based on system design. Refer to the "Design Procedure & Combination Ratio" section of this document for details
 - If outdoor unit is located in a higher position than indoor unit, level difference is 361ft or under.
 - (If the level difference is higher than 164ft, the PDM kit should be installed)
 - *PDM kit: Pressure Drop Modulation kit
 - These products contain R410A which is fluorinated greenhouse gas.
 - Sound pressure was acquired in a dead room. Thus actual noise level may be different depending on the installation conditions.
 - Sound power level is an absolute value that a sound source generates.
 - Sound pressure level is a relative value, depending on the distance and acoustic environment.
 - Sound values are obtained in an anechoic room.
 - Sound values of multi combination are theoretical values based on sound results of individual installed units.
 - Cooling operation is possible at -15°C(5°F) or higher if satisfied following conditions.
 - (If the outdoor temperature below -5°C(23°F), wind(snow) protection duct must be installed on the suction side of the heat exchanger and at least 50%capacity of the connected indoor units must be operated.) However, if the outdoor unit is installed below the indoor unit, cooling operation is possible only at -5°C(23°F) or higher.
 - External static pressure of the model installed as a combined module follows the external static pressure of each single unit.
- For more information regarding capacity correction, please refer to capacity tables available at www.SamsungHVAC.com/downloads.

2. Specification

DVM S2 (208~230V)

Model Name				AM288BXVTFH/AA	AM312BXVTFH/AA	AM336BXVTFH/AA		
Outdoor unit module 1				AM072BXVTFH/AA	AM072BXVTFH/AA	AM096BXVTFH/AA		
Outdoor unit module 2				AM096BXVTFH/AA	AM120BXVTFH/AA	AM120BXVTFH/AA		
Outdoor unit module 3				AM120BXVTFH/AA	AM120BXVTFH/AA	AM120BXVTFH/AA		
Outdoor unit module 4				-	-	-		
Power Supply			Ø, #, V, Hz	3, 3, 208~230, 60	3, 3, 208~230, 60	3, 3, 208~230, 60		
Mode			-	Heat Pump	Heat Pump	Heat Pump		
Performance			TON	24	26	28		
Capacity (Nominal)		Cooling	Btu/h	288,000	312,000	336,000		
		Heating	Btu/h	324,000	351,000	378,000		
Capacity (Rated)		Cooling	Btu/h	274,000	296,000	320,000		
		Heating	Btu/h	308,000	334,000	360,000		
Maximum number of connectable indoor units			EA	49	54	58		
Total capacity of the connected Indoor Units		Min.	Btu/h	144,000	156,000	168,000		
		Max.	Btu/h	374,400	405,600	436,800		
Power		Current		MCA	A	-		
		MOP		A	-	-		
Casing		Material		Body	-	GI Steel Plate		
		Base		-	GI Steel Plate	GI Steel Plate		
Heat Exchanger		Type		-	Fin & Tube	Fin & Tube		
		Material		Fin	-	Al	Al	
				Tube	-	Cu	Cu	
Fin Treatment		-		Anti-corrosion	Anti-corrosion	Anti-corrosion		
Compressor		Type		-	Inverter Scroll x 6	Inverter Scroll x 6		
		Output		kW x n	(4.39 x 2) x 1 + (6.45 x 2) x 2	(4.39 x 2) x 1 + (6.45 x 2) x 2	(6.45 x 2) x 3	
		Model Name		-	(DS2GT7046EV* x 2) x 1 + (DS4GT5066EV* x 2) x 2	(DS2GT7046EV* x 2) x 1 + (DS4GT5066EV* x 2) x 2	(DS4GT5066EV* x 2) x 3	
		Oil		Type		-	PVE	PVE
				Initial charge	cc x n	(900 x 2) x 1 + (1,100 x 2) x 2	(900 x 2) x 1 + (1,100 x 2) x 2	(1,100 x 2) x 3
fl oz x n		(30.4 x 2) x 1 + (37.2 x 2) x 2		(30.4 x 2) x 1 + (37.2 x 2) x 2	(37.2 x 2) x 3			
Fan		Type		-	Propeller	Propeller		
		Discharge direction		-	Top	Top		
		Quantity		EA	6	6	6	
		Air Flow Rate		CFM (m ³ /min)	9,924 x 1 + 9,571 x 1 + 10,171 x 1 (281 x 1 + 271 x 1 + 288 x 1)	9,924 x 1 + 10,171 x 2 (281 x 1 + 288 x 2)	9,571 x 1 + 10,171 x 2 (271 x 1 + 288 x 2)	
		External Static Pressure		Max.		mmAq	-	-
				Pa		-	-	-
in Wg (Pa)				-	-	-		
Fan Motor		Type		-	BLDC Motor	BLDC Motor		
		Output		W x n	(620 x 2) x 3	(620 x 2) x 3	(620 x 2) x 3	
Piping Connections		Liquid Pipe		Type	Braze connection	Braze connection		
				Φ, inch (mm)	3/4 (19.05)	3/4 (19.05)		
		Gas Pipe		Type	Braze connection	Braze connection		
				Φ, inch (mm)	1-3/8 (34.92)	1-3/8 (34.92)		
		Heat Insulation		-		Both liquid and gas pipes	Both liquid and gas pipes	
		Piping length (ODU-IDU)	Max. [Equiv.]	ft	656 [722]	656 [722]	656 [722]	
		Piping length (1st Branch-IDU)	Max.	ft	295	295	295	
		Total piping length (System)	Max.	ft	3,281	3,281	3,281	
Level difference (ODU in highest position)	Max.	ft	361	361	361			
Level difference (IDU in highest position)	Max.	ft	361	361	361			
Level difference (IDU-IDU)	Max.	ft	164	164	164			

2. Specification

DVM S2 (208~230V)

Model Name				AM288BXVTFH/AA	AM312BXVTFH/AA	AM336BXVTFH/AA	
Outdoor unit module 1				AM072BXVTFH/AA	AM072BXVTFH/AA	AM096BXVTFH/AA	
Outdoor unit module 2				AM096BXVTFH/AA	AM120BXVTFH/AA	AM120BXVTFH/AA	
Outdoor unit module 3				AM120BXVTFH/AA	AM120BXVTFH/AA	AM120BXVTFH/AA	
Outdoor unit module 4				-	-	-	
Wiring Connections	Transmission Cable	Min.	mm ²	0.75	0.75	0.75	
		Remark	-	F1, F2	F1, F2	F1, F2	
	Power supply intake		-	-	Both indoor and outdoor unit	Both indoor and outdoor unit	Both indoor and outdoor unit
Refrigerant	Type		-	R410A	R410A	R410A	
	Factory Charging		lbs (kg)	17.6 x 1 + 23.1 x 2 (8.0 x 1 + 10.5 x 2)	17.6 x 1 + 23.1 x 2 (8.0 x 1 + 10.5 x 2)	23.1 x 3 (10.5 x 3)	
Sound	Sound Pressure	Cooling	dB(A)	62.1	62.8	63.2	
		Heating	dB(A)	62.6	63.0	63.5	
	Sound Power		dB(A)	81.9	82.6	83.2	
External Dimension	Net Weight		lbs (kg)	553 x 1 + 644 x 2 (251 x 1 + 292 x 2)	553 x 1 + 644 x 2 (251 x 1 + 292 x 2)	644 x 3 (292 x 3)	
	Shipping Weight		lbs (kg)	591 x 1 + 681 x 2 (268 x 1 + 309 x 2)	591 x 1 + 681 x 2 (268 x 1 + 309 x 2)	681 x 3 (309 x 3)	
	Net Dimensions (WxHxD)			mm	(1,295 x 1,695 x 765) x 3	(1,295 x 1,695 x 765) x 3	(1,295 x 1,695 x 765) x 3
				inch	(51 x 66-3/4 x 30-1/8) x 3	(51 x 66-3/4 x 30-1/8) x 3	(51 x 66-3/4 x 30-1/8) x 3
	Shipping Dimensions (WxHxD)			mm	(1,363 x 1,887 x 829) x 3	(1,363 x 1,887 x 829) x 3	(1,363 x 1,887 x 829) x 3
				inch	(53-11/16 x 74-5/16 x 32-11/16) x 3	(53-11/16 x 74-5/16 x 32-11/16) x 3	(53-11/16 x 74-5/16 x 32-11/16) x 3
Operating Temp. Range	Cooling		°F (°C)	5 ~ 122 (-15 ~ 50)	5 ~ 122 (-15 ~ 50)	5 ~ 122 (-15 ~ 50)	
	Heating		°F (°C)	-22 ~ 75 (-30 ~ 24)	-22 ~ 75 (-30 ~ 24)	-22 ~ 75 (-30 ~ 24)	

NOTE

- Specification may be subject to change without prior notice.
 - Specification comply with EN14511.
- Nominal capacities are based on (Equivalent refrigerant piping : 25ft, Level differences : 0ft);
 - Cooling : Indoor temperature 80°F DB, 67°F WB / Outdoor temperature 95°F DB, 75°F WB
 - Heating : Indoor temperature 70°F DB, 60°F WB / Outdoor temperature 47°F DB, 43°F WB
 - The standard allowed combination ratio of the total rated indoor unit capacity over the rated outdoor unit capacity is 50~130%. Combination ratio of up to 184% is allowed depending on operation mode, minimum operation ratio and connected indoor unit models. DVM Pro 2 design software supports designing over 130% based on system design. Refer to the "Design Procedure & Combination Ratio" section of this document for details
 - If outdoor unit is located in a higher position than indoor unit, level difference is 361ft or under.
 - (If the level difference is higher than 164ft, the PDM kit should be installed)
 - *PDM kit: Pressure Drop Modulation kit
 - These products contain R410A which is fluorinated greenhouse gas.
 - Sound pressure was acquired in a dead room. Thus actual noise level may be different depending on the installation conditions.
 - Sound power level is an absolute value that a sound source generates.
 - Sound pressure level is a relative value, depending on the distance and acoustic environment.
 - Sound values are obtained in an anechoic room.
 - Sound values of multi combination are theoretical values based on sound results of individual installed units.
 - Cooling operation is possible at -15°C(5°F) or higher if satisfied following conditions.
 - (If the outdoor temperature below -5°C(23°F), wind(snow) protection duct must be installed on the suction side of the heat exchanger and at least 50%capacity of the connected indoor units must be operated.) However, if the outdoor unit is installed below the indoor unit, cooling operation is possible only at -5°C(23°F) or higher.
 - External static pressure of the model installed as a combined module follows the external static pressure of each single unit.
- For more information regarding capacity correction, please refer to capacity tables available at www.SamsungHVAC.com/downloads.

2. Specification

DVM S2 (208~230V)

Model Name				AM360BXVTFH/AA	
Outdoor unit module 1				AM120BXVTFH/AA	
Outdoor unit module 2				AM120BXVTFH/AA	
Outdoor unit module 3				AM120BXVTFH/AA	
Outdoor unit module 4				-	
Power Supply			Ø, #, V, Hz	3, 3, 208~230, 60	
Mode			-	Heat Pump	
Performance			TON	30	
Capacity (Nominal)		Cooling	Btu/h	360,000	
		Heating	Btu/h	405,000	
Capacity (Rated)		Cooling	Btu/h	342,000	
		Heating	Btu/h	386,000	
Maximum number of connectable indoor units			EA	62	
Total capacity of the connected Indoor Units		Min.	Btu/h	180,000	
		Max.	Btu/h	468,000	
Power	Current	MCA	A	-	
		MOP	A	-	
Casing	Material	Body	-	GI Steel Plate	
		Base	-	GI Steel Plate	
Heat Exchanger	Type		-	Fin & Tube	
	Material	Fin	-	Al	
		Tube	-	Cu	
	Fin Treatment		-	Anti-corrosion	
Compressor	Type		-	Inverter Scroll x 6	
	Output		kW x n	(6.45 x 2) x 3	
	Model Name		-	(DS4GT5066EV* x 2) x 3	
	Oil	Type		-	PVE
		Initial charge	cc x n	-	(1,100 x 2) x 3
			fl oz x n	-	(37.2 x 2) x 3
Fan	Type		-	Propeller	
	Discharge direction		-	Top	
	Quantity		EA	6	
	Air Flow Rate		CFM (m ³ /min)	10,171 x 3 (288 x 3)	
	External Static Pressure	Max.	mmAq	-	
			Pa	-	
in Wg (Pa)			-		
Fan Motor	Type		-	BLDC Motor	
	Output		W x n	(620 x 2) x 3	
Piping Connections	Liquid Pipe		Type	Braze connection	
			Ø, inch (mm)	3/4 (19.05)	
	Gas Pipe		Type	Braze connection	
			Ø, inch (mm)	1-5/8 (41.28)	
	Heat Insulation		-	Both liquid and gas pipes	
	Piping length (ODU-IDU)	Max. [Equiv.]	ft	656 [722]	
	Piping length (1st Branch-IDU)	Max.	ft	295	
	Total piping length (System)	Max.	ft	3,281	
	Level difference (ODU in highest position)	Max.	ft	361	
Level difference (IDU in highest position)	Max.	ft	361		
Level difference (IDU-IDU)	Max.	ft	164		

2. Specification

DVM S2 (208~230V)

Model Name			AM360BXVTFH/AA		
Outdoor unit module 1			AM120BXVTFH/AA		
Outdoor unit module 2			AM120BXVTFH/AA		
Outdoor unit module 3			AM120BXVTFH/AA		
Outdoor unit module 4			-		
Wiring Connections	Transmission Cable	Min.	mm ²	0.75	
		Remark	-	F1, F2	
	Power supply intake		-	Both indoor and outdoor unit	
Refrigerant	Type		-	R410A	
	Factory Charging		lbs (kg)	23.1 x 3 (10.5 x 3)	
Sound	Sound Pressure	Cooling	dB(A)	63.8	
		Heating	dB(A)	63.8	
	Sound Power		dB(A)	83.8	
External Dimension	Net Weight		lbs (kg)	644 x 3 (292 x 3)	
	Shipping Weight		lbs (kg)	681 x 3 (309 x 3)	
	Net Dimensions (WxHxD)			mm	(1,295 x 1,695 x 765) x 3
				inch	(51 x 66-3/4 x 30-1/8) x 3
	Shipping Dimensions (WxHxD)			mm	(1,363 x 1,887 x 829) x 3
				inch	(53-11/16 x 74-5/16 x 32-11/16) x 3
Operating Temp. Range	Cooling		°F (°C)	5 ~ 122 (-15 ~ 50)	
	Heating		°F (°C)	-22 ~ 75 (-30 ~ 24)	

NOTE

- Specification may be subject to change without prior notice.
 - Specification comply with EN14511.
- 1) Nominal capacities are based on (Equivalent refrigerant piping : 25ft, Level differences : 0ft);
 - Cooling : Indoor temperature 80°F DB, 67°F WB / Outdoor temperature 95°F DB, 75°F WB
 - Heating : Indoor temperature 70°F DB, 60°F WB / Outdoor temperature 47°F DB, 43°F WB
 - 2) The standard allowed combination ratio of the total rated indoor unit capacity over the rated outdoor unit capacity is 50~130%. Combination ratio of up to 184% is allowed depending on operation mode, minimum operation ratio and connected indoor unit models. DVM Pro 2 design software supports designing over 130% based on system design. Refer to the "Design Procedure & Combination Ratio" section of this document for details
 - 3) If outdoor unit is located in a higher position than indoor unit, level difference is 361ft or under.
 - (If the level difference is higher than 164ft, the PDM kit should be installed)
 - *PDM kit: Pressure Drop Modulation kit
 - 4) These products contain R410A which is fluorinated greenhouse gas.
 - 5) Sound pressure was acquired in a dead room. Thus actual noise level may be different depending on the installation conditions.
 - 6) Sound power level is an absolute value that a sound source generates.
 - Sound pressure level is a relative value, depending on the distance and acoustic environment.
 - Sound values are obtained in an anechoic room.
 - Sound values of multi combination are theoretical values based on sound results of individual installed units.
 - 7) Cooling operation is possible at -15°C(5°F) or higher if satisfied following conditions.
 - (If the outdoor temperature below -5°C(23°F), wind(snow) protection duct must be installed on the suction side of the heat exchanger and at least 50%capacity of the connected indoor units must be operated.) However, if the outdoor unit is installed below the indoor unit, cooling operation is possible only at -5°C(23°F) or higher.
 - 8) External static pressure of the model installed as a combined module follows the external static pressure of each single unit.
- For more information regarding capacity correction, please refer to capacity tables available at www.SamsungHVAC.com/downloads.

2. Specification

DVM S2 (460V)

Model Name				AM072BXVTJH/AA	AM096BXVTJH/AA	AM120BXVTJH/AA		
Outdoor unit module 1				-	-	-		
Outdoor unit module 2				-	-	-		
Outdoor unit module 3				-	-	-		
Outdoor unit module 4				-	-	-		
Power Supply			Ø, #, V, Hz	3, 3, 460, 60	3, 3, 460, 60	3, 3, 460, 60		
Mode			-	Heat Pump	Heat Pump	Heat Pump		
Performance			TON	6	8	10		
Capacity (Nominal)		Cooling	Btu/h	72,000	96,000	120,000		
		Heating	Btu/h	81,000	108,000	135,000		
Capacity (Rated)		Cooling	Btu/h	69,000	92,000	114,000		
		Heating	Btu/h	77,000	103,000	129,000		
Maximum number of connectable indoor units			EA	12	16	20		
Total capacity of the connected Indoor Units		Min.	Btu/h	36,000	48,000	60,000		
		Max.	Btu/h	93,600	124,800	156,000		
Power		Current		MCA	A	25.0		
				MOP	A	30		
Casing		Material		Body	-	GI Steel Plate		
				Base	-	GI Steel Plate		
Heat Exchanger		Type		-	-	Fin & Tube		
		Material		Fin	-	Al		
				Tube	-	Cu		
		Fin Treatment		-	-	Anti-corrosion		
Compressor		Type		-	-	Inverter Scroll x 2		
		Output		kW x n	4.39 x 2	6.67 x 2		
		Model Name		-	-	DS2GR7046FV* x 2		
		Oil		Type		-	-	PVE
				Initial charge		cc x n	900 x 2	1,100 x 2
						fl oz x n	30.4 x 2	37.2 x 2
Fan		Type		-	-	Propeller		
		Discharge direction		-	-	Top		
		Quantity		EA	2	2		
		Air Flow Rate		CFM (m ³ /min)	9,924 (281)	9,571 (271)		
		External Static Pressure		Max.		mmAq	11	11
						Pa	110	110
				in Wg (Pa)	0.43 (107.87)	0.43 (107.87)		
Fan Motor		Type		-	-	BLDC Motor		
		Output		W x n	620 x 2	620 x 2		
Piping Connections		Liquid Pipe		Type	-	Braze connection		
				Ø, inch (mm)	3/8 (9.52)	3/8 (9.52)		
		Gas Pipe		Type	-	Braze connection		
				Ø, inch (mm)	3/4 (19.05)	7/8 (22.22)		
		Heat Insulation		-	-	Both liquid and gas pipes		
		Piping length (ODU-IDU)		Max. [Equiv.]	ft	656 [722]		
		Piping length (1st Branch-IDU)		Max.	ft	295		
		Total piping length (System)		Max.	ft	3,281		
		Level difference (ODU in highest position)		Max.	ft	361		
		Level difference (IDU in highest position)		Max.	ft	361		
Level difference (IDU-IDU)		Max.	ft	164				

2. Specification

DVM S2 (460V)

Model Name				AM072BXVTJH/AA	AM096BXVTJH/AA	AM120BXVTJH/AA	
Outdoor unit module 1				-	-	-	
Outdoor unit module 2				-	-	-	
Outdoor unit module 3				-	-	-	
Outdoor unit module 4				-	-	-	
Wiring Connections	Transmission Cable	Min.	mm ²	0.75	0.75	0.75	
		Remark	-	F1, F2	F1, F2	F1, F2	
	Power supply intake			-	Both indoor and outdoor unit	Both indoor and outdoor unit	Both indoor and outdoor unit
Refrigerant	Type		-	R410A	R410A	R410A	
	Factory Charging		lbs (kg)	17.6 (8.0)	23.1 (10.5)	23.1 (10.5)	
Sound	Sound Pressure	Cooling	dB(A)	55.0	57.0	59.0	
		Heating	dB(A)	56.0	58.0	59.0	
	Sound Power		dB(A)	74.0	77.0	79.0	
External Dimension	Net Weight		lbs (kg)	571 (259)	661 (300)	661 (300)	
	Shipping Weight		lbs (kg)	608 (276)	699 (317)	699 (317)	
	Net Dimensions (WxHxD)			mm	1,295 x 1,695 x 765	1,295 x 1,695 x 765	1,295 x 1,695 x 765
				inch	51 x 66-3/4 x 30-1/8	51 x 66-3/4 x 30-1/8	51 x 66-3/4 x 30-1/8
	Shipping Dimensions (WxHxD)			mm	1,363 x 1,887 x 829	1,363 x 1,887 x 829	1,363 x 1,887 x 829
				inch	53-11/16 x 74-5/16 x 32-11/16	53-11/16 x 74-5/16 x 32-11/16	53-11/16 x 74-5/16 x 32-11/16
Operating Temp. Range	Cooling		°F (°C)	5 ~ 122 (-15 ~ 50)	5 ~ 122 (-15 ~ 50)	5 ~ 122 (-15 ~ 50)	
	Heating		°F (°C)	-22 ~ 75 (-30 ~ 24)	-22 ~ 75 (-30 ~ 24)	-22 ~ 75 (-30 ~ 24)	

NOTE

- Specification may be subject to change without prior notice.
 - Specification comply with EN14511.
- Nominal capacities are based on (Equivalent refrigerant piping : 25ft, Level differences : 0ft);
 - Cooling : Indoor temperature 80°F DB, 67°F WB / Outdoor temperature 95°F DB, 75°F WB
 - Heating : Indoor temperature 70°F DB, 60°F WB / Outdoor temperature 47°F DB, 43°F WB
 - The standard allowed combination ratio of the total rated indoor unit capacity over the rated outdoor unit capacity is 50~130%. Combination ratio of up to 184% is allowed depending on operation mode, minimum operation ratio and connected indoor unit models. DVM Pro 2 design software supports designing over 130% based on system design. Refer to the "Design Procedure & Combination Ratio" section of this document for details
 - If outdoor unit is located in a higher position than indoor unit, level difference is 361ft or under.
 - (If the level difference is higher than 164ft, the PDM kit should be installed)
 - *PDM kit: Pressure Drop Modulation kit
 - These products contain R410A which is fluorinated greenhouse gas.
 - Sound pressure was acquired in a dead room. Thus actual noise level may be different depending on the installation conditions.
 - Sound power level is an absolute value that a sound source generates.
 - Sound pressure level is a relative value, depending on the distance and acoustic environment.
 - Sound values are obtained in an anechoic room.
 - Sound values of multi combination are theoretical values based on sound results of individual installed units.
 - Cooling operation is possible at -15°C(5°F) or higher if satisfied following conditions.
 - (If the outdoor temperature below -5°C(23°F), wind(snow) protection duct must be installed on the suction side of the heat exchanger and at least 50%capacity of the connected indoor units must be operated.) However, if the outdoor unit is installed below the indoor unit, cooling operation is possible only at -5°C(23°F) or higher.
 - External static pressure of the model installed as a combined module follows the external static pressure of each single unit.
- For more information regarding capacity correction, please refer to capacity tables available at www.SamsungHVAC.com/downloads.

2. Specification

DVM S2 (460V)

Model Name				AM144BXVTJH/AA	AM168BXVTJH/AA	AM192BXVTJH/AA	
Outdoor unit module 1				AM072BXVTJH/AA	AM072BXVTJH/AA	AM072BXVTJH/AA	
Outdoor unit module 2				AM072BXVTJH/AA	AM096BXVTJH/AA	AM120BXVTJH/AA	
Outdoor unit module 3				-	-	-	
Outdoor unit module 4				-	-	-	
Power Supply			Ø, #, V, Hz	3, 3, 460, 60	3, 3, 460, 60	3, 3, 460, 60	
Mode			-	Heat Pump	Heat Pump	Heat Pump	
Performance			TON	12	14	16	
Capacity (Nominal)		Cooling	Btu/h	144,000	168,000	192,000	
		Heating	Btu/h	162,000	189,000	216,000	
Capacity (Rated)		Cooling	Btu/h	138,000	160,000	182,000	
		Heating	Btu/h	154,000	180,000	206,000	
Maximum number of connectable indoor units			EA	25	29	33	
Total capacity of the connected Indoor Units		Min.	Btu/h	72,000	84,000	96,000	
		Max.	Btu/h	187,200	218,400	249,600	
Power		Current		MCA	A	-	
		MOP		A	-	-	
Casing		Material		Body	-	GI Steel Plate	
		Base		-	GI Steel Plate	GI Steel Plate	
Heat Exchanger		Type		-	Fin & Tube	Fin & Tube	
		Material		Fin	-	Al	Al
				Tube	-	Cu	Cu
		Fin Treatment		-	Anti-corrosion	Anti-corrosion	Anti-corrosion
Compressor		Type		-	Inverter Scroll x 4	Inverter Scroll x 4	
		Output		kW x n	(4.39 x 2) x 2	(4.39 x 2) x 1 + (6.67 x 2) x 1	(4.39 x 2) x 1 + (6.67 x 2) x 1
		Model Name		-	(DS2GR7046FV* x 2) x 2	(DS2GR7046FV* x 2) x 1 + (DS4GR7066FV* x 2) x 1	(DS2GR7046FV* x 2) x 1 + (DS4GR7066FV* x 2) x 1
		Oil		Type	-	PVE	PVE
				Initial charge	cc x n	(900 x 2) x 2	(900 x 2) x 1 + (1,100 x 2) x 1
			fl oz x n	(30.4 x 2) x 2	(30.4 x 2) x 1 + (37.2 x 2) x 1	(30.4 x 2) x 1 + (37.2 x 2) x 1	
Fan		Type		-	Propeller	Propeller	
		Discharge direction		-	Top	Top	
		Quantity		EA	4	4	4
		Air Flow Rate		CFM (m ³ /min)	9,924 x 2 (281 x 2)	9,924 x 1 + 9,571 x 1 (281 x 1 + 271 x 1)	9,924 x 1 + 10,171 x 1 (281 x 1 + 288 x 1)
		External Static Pressure		Max.	mmAq	-	-
					Pa	-	-
			in Wg (Pa)	-	-		
Fan Motor		Type		-	BLDC Motor	BLDC Motor	
		Output		W x n	(620 x 2) x 2	(620 x 2) x 2	(620 x 2) x 2
Piping Connections		Liquid Pipe		Type	Braze connection	Braze connection	
				Ø, inch (mm)	1/2 (12.70)	5/8 (15.88)	
		Gas Pipe		Type	Braze connection	Braze connection	
				Ø, inch (mm)	1-1/8 (28.58)	1-1/8 (28.58)	
		Heat Insulation		-	Both liquid and gas pipes	Both liquid and gas pipes	
		Piping length (ODU-IDU)	Max. [Equiv.]	ft	656 [722]	656 [722]	
		Piping length (1st Branch-IDU)	Max.	ft	295	295	
		Total piping length (System)	Max.	ft	3,281	3,281	
Level difference (ODU in highest position)	Max.	ft	361	361			
Level difference (IDU in highest position)	Max.	ft	361	361			
Level difference (IDU-IDU)	Max.	ft	164	164			

2. Specification

DVM S2 (460V)

Model Name				AM144BXVTJH/AA	AM168BXVTJH/AA	AM192BXVTJH/AA	
Outdoor unit module 1				AM072BXVTJH/AA	AM072BXVTJH/AA	AM072BXVTJH/AA	
Outdoor unit module 2				AM072BXVTJH/AA	AM096BXVTJH/AA	AM120BXVTJH/AA	
Outdoor unit module 3				-	-	-	
Outdoor unit module 4				-	-	-	
Wiring Connections	Transmission Cable	Min.	mm ²	0.75	0.75	0.75	
		Remark	-	F1, F2	F1, F2	F1, F2	
	Power supply intake				Both indoor and outdoor unit	Both indoor and outdoor unit	Both indoor and outdoor unit
Refrigerant	Type		-	R410A	R410A	R410A	
	Factory Charging		lbs (kg)	17.6 x 2 (8.0 x 2)	17.6 x 1 + 23.1 x 1 (8.0 x 1 + 10.5 x 1)	17.6 x 1 + 23.1 x 1 (8.0 x 1 + 10.5 x 1)	
Sound	Sound Pressure	Cooling	dB(A)	58.0	59.1	60.5	
		Heating	dB(A)	59.0	60.1	60.8	
	Sound Power		dB(A)		77.0	78.8	80.2
External Dimension	Net Weight		lbs (kg)	571 x 2 (259 x 2)	571 x 1 + 661 x 1 (259 x 1 + 300 x 1)	571 x 1 + 661 x 1 (259 x 1 + 300 x 1)	
	Shipping Weight		lbs (kg)	608 x 2 (276 x 2)	608 x 1 + 699 x 1 (276 x 1 + 317 x 1)	608 x 1 + 699 x 1 (276 x 1 + 317 x 1)	
	Net Dimensions (WxHxD)			mm	(1,295 x 1,695 x 765) x 2	(1,295 x 1,695 x 765) x 2	(1,295 x 1,695 x 765) x 2
				inch	(51 x 66-3/4 x 30-1/8) x 2	(51 x 66-3/4 x 30-1/8) x 2	(51 x 66-3/4 x 30-1/8) x 2
	Shipping Dimensions (WxHxD)			mm	(1,363 x 1,887 x 829) x 2	(1,363 x 1,887 x 829) x 2	(1,363 x 1,887 x 829) x 2
				inch	(53-11/16 x 74-5/16 x 32-11/16) x 2	(53-11/16 x 74-5/16 x 32-11/16) x 2	(53-11/16 x 74-5/16 x 32-11/16) x 2
Operating Temp. Range	Cooling		°F (°C)	5 ~ 122 (-15 ~ 50)	5 ~ 122 (-15 ~ 50)	5 ~ 122 (-15 ~ 50)	
	Heating		°F (°C)	-22 ~ 75 (-30 ~ 24)	-22 ~ 75 (-30 ~ 24)	-22 ~ 75 (-30 ~ 24)	

NOTE

- Specification may be subject to change without prior notice.
 - Specification comply with EN14511.
- Nominal capacities are based on (Equivalent refrigerant piping : 25ft, Level differences : 0ft);
 - Cooling : Indoor temperature 80°F DB, 67°F WB / Outdoor temperature 95°F DB, 75°F WB
 - Heating : Indoor temperature 70°F DB, 60°F WB / Outdoor temperature 47°F DB, 43°F WB
 - The standard allowed combination ratio of the total rated indoor unit capacity over the rated outdoor unit capacity is 50~130%. Combination ratio of up to 184% is allowed depending on operation mode, minimum operation ratio and connected indoor unit models. DVM Pro 2 design software supports designing over 130% based on system design. Refer to the "Design Procedure & Combination Ratio" section of this document for details
 - If outdoor unit is located in a higher position than indoor unit, level difference is 361ft or under.
 - (If the level difference is higher than 164ft, the PDM kit should be installed)
 - *PDM kit: Pressure Drop Modulation kit
 - These products contain R410A which is fluorinated greenhouse gas.
 - Sound pressure was acquired in a dead room. Thus actual noise level may be different depending on the installation conditions.
 - Sound power level is an absolute value that a sound source generates.
 - Sound pressure level is a relative value, depending on the distance and acoustic environment.
 - Sound values are obtained in an anechoic room.
 - Sound values of multi combination are theoretical values based on sound results of individual installed units.
 - Cooling operation is possible at -15°C(5°F) or higher if satisfied following conditions.
 - (If the outdoor temperature below -5°C(23°F), wind(snow) protection duct must be installed on the suction side of the heat exchanger and at least 50%capacity of the connected indoor units must be operated.) However, if the outdoor unit is installed below the indoor unit, cooling operation is possible only at -5°C(23°F) or higher.
 - External static pressure of the model installed as a combined module follows the external static pressure of each single unit.
- For more information regarding capacity correction, please refer to capacity tables available at www.SamsungHVAC.com/downloads.

2. Specification

DVM S2 (460V)

Model Name				AM216BXVTJH/AA	AM240BXVTJH/AA	AM264BXVTJH/AA	
Outdoor unit module 1				AM096BXVTJH/AA	AM120BXVTJH/AA	AM072BXVTJH/AA	
Outdoor unit module 2				AM120BXVTJH/AA	AM120BXVTJH/AA	AM072BXVTJH/AA	
Outdoor unit module 3				-	-	AM120BXVTJH/AA	
Outdoor unit module 4				-	-	-	
Power Supply			Ø, #, V, Hz	3, 3, 460, 60	3, 3, 460, 60	3, 3, 460, 60	
Mode			-	Heat Pump	Heat Pump	Heat Pump	
Performance			TON	18	20	22	
Capacity (Nominal)		Cooling	Btu/h	216,000	240,000	264,000	
		Heating	Btu/h	243,000	270,000	297,000	
Capacity (Rated)		Cooling	Btu/h	206,000	228,000	252,000	
		Heating	Btu/h	232,000	258,000	282,000	
Maximum number of connectable indoor units			EA	37	41	45	
Total capacity of the connected Indoor Units		Min.	Btu/h	108,000	120,000	132,000	
		Max.	Btu/h	280,800	312,000	343,200	
Power		Current	MCA	A	-	-	
			MOP	A	-	-	
Casing		Material	Body	-	GI Steel Plate	GI Steel Plate	
			Base	-	GI Steel Plate	GI Steel Plate	
Heat Exchanger		Type		-	Fin & Tube	Fin & Tube	
		Material		Fin	-	Al	Al
				Tube	-	Cu	Cu
		Fin Treatment		-	Anti-corrosion	Anti-corrosion	Anti-corrosion
Compressor		Type		-	Inverter Scroll x 4	Inverter Scroll x 4	
		Output		kW x n	(6.67 x 2) x 2	(6.67 x 2) x 2	(4.39 x 2) x 2 + (6.67 x 2) x 1
		Model Name		-	(DS4GR7066FV* x 2) x 2	(DS4GR7066FV* x 2) x 2	(DS2GR7046FV* x 2) x 2 + (DS4GR7066FV* x 2) x 1
		Oil		Type	-	PVE	PVE
				Initial charge	cc x n	(1,100 x 2) x 2	(1,100 x 2) x 2
			fl oz x n	(37.2 x 2) x 2	(37.2 x 2) x 2	(30.4 x 2) x 2 + (37.2 x 2) x 1	
Fan		Type		-	Propeller	Propeller	
		Discharge direction		-	Top	Top	Top
		Quantity		EA	4	4	6
		Air Flow Rate		CFM (m ³ /min)	9,571 x 1 + 10,171 x 1 (271 x 1 + 288 x 1)	10,171 x 2 (288 x 2)	9,924 x 2 + 10,171 x 1 (281 x 2 + 288 x 1)
		External Static Pressure		Max.	mmAq	-	-
					Pa	-	-
			in Wg (Pa)	-	-		
Fan Motor		Type		-	BLDC Motor	BLDC Motor	
		Output		W x n	(620 x 2) x 2	(620 x 2) x 2	(620 x 2) x 3
Piping Connections		Liquid Pipe		Type	Braze connection	Braze connection	
				Ø, inch (mm)	5/8 (15.88)	5/8 (15.88)	
		Gas Pipe		Type	Braze connection	Braze connection	
				Ø, inch (mm)	1-1/8 (28.58)	1-3/8 (34.92)	
		Heat Insulation		-	Both liquid and gas pipes	Both liquid and gas pipes	
		Piping length (ODU-IDU)	Max. [Equiv.]	ft	656 [722]	656 [722]	
		Piping length (1st Branch-IDU)	Max.	ft	295	295	
		Total piping length (System)	Max.	ft	3,281	3,281	
Level difference (ODU in highest position)	Max.	ft	361	361			
Level difference (IDU in highest position)	Max.	ft	361	361			
Level difference (IDU-IDU)	Max.	ft	164	164			

2. Specification

DVM S2 (460V)

Model Name				AM216BXVTJH/AA	AM240BXVTJH/AA	AM264BXVTJH/AA	
Outdoor unit module 1				AM096BXVTJH/AA	AM120BXVTJH/AA	AM072BXVTJH/AA	
Outdoor unit module 2				AM120BXVTJH/AA	AM120BXVTJH/AA	AM072BXVTJH/AA	
Outdoor unit module 3				-	-	AM120BXVTJH/AA	
Outdoor unit module 4				-	-	-	
Wiring Connections	Transmission Cable	Min.	mm ²	0.75	0.75	0.75	
		Remark	-	F1, F2	F1, F2	F1, F2	
Power supply intake			-	Both indoor and outdoor unit	Both indoor and outdoor unit	Both indoor and outdoor unit	
Refrigerant	Type		-	R410A	R410A	R410A	
	Factory Charging		lbs (kg)	23.1 x 2 (10.5 x 2)	23.1 x 2 (10.5 x 2)	17.6 x 2 + 23.1 x 1 (8.0 x 2 + 10.5 x 1)	
Sound	Sound Pressure	Cooling	dB(A)	61.1	62.0	61.5	
		Heating	dB(A)	61.5	62.0	62.0	
	Sound Power		dB(A)	81.1	82.0	81.1	
External Dimension	Net Weight		lbs (kg)	661 x 2 (300 x 2)	661 x 2 (300 x 2)	571 x 2 + 661 x 1 (259 x 2 + 300 x 1)	
	Shipping Weight		lbs (kg)	699 x 2 (317 x 2)	699 x 2 (317 x 2)	608 x 2 + 699 x 1 (276 x 2 + 317 x 1)	
	Net Dimensions (WxHxD)			mm	(1,295 x 1,695 x 765) x 2	(1,295 x 1,695 x 765) x 2	(1,295 x 1,695 x 765) x 3
				inch	(51 x 66-3/4 x 30-1/8) x 2	(51 x 66-3/4 x 30-1/8) x 2	(51 x 66-3/4 x 30-1/8) x 3
	Shipping Dimensions (WxHxD)			mm	(1,363 x 1,887 x 829) x 2	(1,363 x 1,887 x 829) x 2	(1,363 x 1,887 x 829) x 3
				inch	(53-11/16 x 74-5/16 x 32-11/16) x 2	(53-11/16 x 74-5/16 x 32-11/16) x 2	(53-11/16 x 74-5/16 x 32-11/16) x 3
Operating Temp. Range	Cooling		°F (°C)	5 ~ 122 (-15 ~ 50)	5 ~ 122 (-15 ~ 50)	5 ~ 122 (-15 ~ 50)	
	Heating		°F (°C)	-22 ~ 75 (-30 ~ 24)	-22 ~ 75 (-30 ~ 24)	-22 ~ 75 (-30 ~ 24)	

NOTE

- Specification may be subject to change without prior notice.
 - Specification comply with EN14511.
- Nominal capacities are based on (Equivalent refrigerant piping : 25ft, Level differences : 0ft);
 - Cooling : Indoor temperature 80°F DB, 67°F WB / Outdoor temperature 95°F DB, 75°F WB
 - Heating : Indoor temperature 70°F DB, 60°F WB / Outdoor temperature 47°F DB, 43°F WB
 - The standard allowed combination ratio of the total rated indoor unit capacity over the rated outdoor unit capacity is 50~130%. Combination ratio of up to 184% is allowed depending on operation mode, minimum operation ratio and connected indoor unit models. DVM Pro 2 design software supports designing over 130% based on system design. Refer to the "Design Procedure & Combination Ratio" section of this document for details
 - If outdoor unit is located in a higher position than indoor unit, level difference is 361ft or under.
 - (If the level difference is higher than 164ft, the PDM kit should be installed)
 - *PDM kit: Pressure Drop Modulation kit
 - These products contain R410A which is fluorinated greenhouse gas.
 - Sound pressure was acquired in a dead room. Thus actual noise level may be different depending on the installation conditions.
 - Sound power level is an absolute value that a sound source generates.
 - Sound pressure level is a relative value, depending on the distance and acoustic environment.
 - Sound values are obtained in an anechoic room.
 - Sound values of multi combination are theoretical values based on sound results of individual installed units.
 - Cooling operation is possible at -15°C(5°F) or higher if satisfied following conditions.
 - (If the outdoor temperature below -5°C(23°F), wind(snow) protection duct must be installed on the suction side of the heat exchanger and at least 50%capacity of the connected indoor units must be operated.) However, if the outdoor unit is installed below the indoor unit, cooling operation is possible only at -5°C(23°F) or higher.
 - External static pressure of the model installed as a combined module follows the external static pressure of each single unit.
- For more information regarding capacity correction, please refer to capacity tables available at www.SamsungHVAC.com/downloads.

2. Specification

DVM S2 (460V)

Model Name				AM288BXVTJH/AA	AM312BXVTJH/AA	AM336BXVTJH/AA	
Outdoor unit module 1				AM072BXVTJH/AA	AM072BXVTJH/AA	AM096BXVTJH/AA	
Outdoor unit module 2				AM096BXVTJH/AA	AM120BXVTJH/AA	AM120BXVTJH/AA	
Outdoor unit module 3				AM120BXVTJH/AA	AM120BXVTJH/AA	AM120BXVTJH/AA	
Outdoor unit module 4				-	-	-	
Power Supply			Ø, #, V, Hz	3, 3, 460, 60	3, 3, 460, 60	3, 3, 460, 60	
Mode			-	Heat Pump	Heat Pump	Heat Pump	
Performance			TON	24	26	28	
Capacity (Nominal)		Cooling	Btu/h	288,000	312,000	336,000	
		Heating	Btu/h	324,000	351,000	378,000	
Capacity (Rated)		Cooling	Btu/h	274,000	296,000	320,000	
		Heating	Btu/h	308,000	334,000	360,000	
Maximum number of connectable indoor units			EA	49	54	58	
Total capacity of the connected Indoor Units		Min.	Btu/h	144,000	156,000	168,000	
		Max.	Btu/h	374,400	405,600	436,800	
Power		Current		MCA	A	-	
		MOP		A	-	-	
Casing		Material		Body	-	GI Steel Plate	
		Base		-	GI Steel Plate	GI Steel Plate	
Heat Exchanger		Type		-	Fin & Tube	Fin & Tube	
		Material		Fin	-	Al	Al
				Tube	-	Cu	Cu
		Fin Treatment		-	Anti-corrosion	Anti-corrosion	Anti-corrosion
Compressor		Type		-	Inverter Scroll x 6	Inverter Scroll x 6	
		Output		kW x n	(4.39 x 2) x 1 + (6.67 x 2) x 2	(4.39 x 2) x 1 + (6.67 x 2) x 2	(6.67 x 2) x 3
		Model Name		-	(DS2GR7046FV* x 2) x 1 + (DS4GR7066FV* x 2) x 2	(DS2GR7046FV* x 2) x 1 + (DS4GR7066FV* x 2) x 2	(DS4GR7066FV* x 2) x 3
		Oil		Type	-	PVE	PVE
				Initial charge	cc x n	(900 x 2) x 1 + (1,100 x 2) x 2	(900 x 2) x 1 + (1,100 x 2) x 2
fl oz x n		(30.4 x 2) x 1 + (37.2 x 2) x 2	(30.4 x 2) x 1 + (37.2 x 2) x 2	(37.2 x 2) x 3			
Fan		Type		-	Propeller	Propeller	
		Discharge direction		-	Top	Top	
		Quantity		EA	6	6	
		Air Flow Rate		CFM (m ³ /min)	9,924 x 1 + 9,571 x 1 + 10,171 x 1 (281 x 1 + 271 x 1 + 288 x 1)	9,924 x 1 + 10,171 x 2 (281 x 1 + 288 x 2)	9,571 x 1 + 10,171 x 2 (271 x 1 + 288 x 2)
		External Static Pressure		Max.	mmAq	-	-
					Pa	-	-
in Wg (Pa)	-				-		
Fan Motor		Type		-	BLDC Motor	BLDC Motor	
		Output		W x n	(620 x 2) x 3	(620 x 2) x 3	
Piping Connections		Liquid Pipe		Type	Braze connection	Braze connection	
				Ø, inch (mm)	3/4 (19.05)	3/4 (19.05)	
		Gas Pipe		Type	Braze connection	Braze connection	
				Ø, inch (mm)	1-3/8 (34.92)	1-3/8 (34.92)	
		Heat Insulation		-	Both liquid and gas pipes	Both liquid and gas pipes	
		Piping length (ODU-IDU)	Max. [Equiv.]	ft	656 [722]	656 [722]	
		Piping length (1st Branch-IDU)	Max.	ft	295	295	
		Total piping length (System)	Max.	ft	3,281	3,281	
Level difference (ODU in highest position)	Max.	ft	361	361			
Level difference (IDU in highest position)	Max.	ft	361	361			
Level difference (IDU-IDU)	Max.	ft	164	164			

2. Specification

DVM S2 (460V)

Model Name				AM288BXVTJH/AA	AM312BXVTJH/AA	AM336BXVTJH/AA	
Outdoor unit module 1				AM072BXVTJH/AA	AM072BXVTJH/AA	AM096BXVTJH/AA	
Outdoor unit module 2				AM096BXVTJH/AA	AM120BXVTJH/AA	AM120BXVTJH/AA	
Outdoor unit module 3				AM120BXVTJH/AA	AM120BXVTJH/AA	AM120BXVTJH/AA	
Outdoor unit module 4				-	-	-	
Wiring Connections	Transmission Cable	Min.	mm ²	0.75	0.75	0.75	
		Remark	-	F1, F2	F1, F2	F1, F2	
	Power supply intake			-	Both indoor and outdoor unit	Both indoor and outdoor unit	Both indoor and outdoor unit
Refrigerant	Type		-	R410A	R410A	R410A	
	Factory Charging		lbs (kg)	17.6 x 1 + 23.1 x 2 (8.0 x 1 + 10.5 x 2)	17.6 x 1 + 23.1 x 2 (8.0 x 1 + 10.5 x 2)	23.1 x 3 (10.5 x 3)	
Sound	Sound Pressure	Cooling	dB(A)	62.1	62.8	63.2	
		Heating	dB(A)	62.6	63.0	63.5	
	Sound Power		dB(A)	81.9	82.6	83.2	
External Dimension	Net Weight		lbs (kg)	571 x 1 + 661 x 2 (259 x 1 + 300 x 2)	571 x 1 + 661 x 2 (259 x 1 + 300 x 2)	661 x 3 (300 x 3)	
	Shipping Weight		lbs (kg)	608 x 1 + 699 x 2 (276 x 1 + 317 x 2)	608 x 1 + 699 x 2 (276 x 1 + 317 x 2)	699 x 3 (317 x 3)	
	Net Dimensions (WxHxD)			mm	(1,295 x 1,695 x 765) x 3	(1,295 x 1,695 x 765) x 3	(1,295 x 1,695 x 765) x 3
				inch	(51 x 66-3/4 x 30-1/8) x 3	(51 x 66-3/4 x 30-1/8) x 3	(51 x 66-3/4 x 30-1/8) x 3
	Shipping Dimensions (WxHxD)			mm	(1,363 x 1,887 x 829) x 3	(1,363 x 1,887 x 829) x 3	(1,363 x 1,887 x 829) x 3
				inch	(53-11/16 x 74-5/16 x 32-11/16) x 3	(53-11/16 x 74-5/16 x 32-11/16) x 3	(53-11/16 x 74-5/16 x 32-11/16) x 3
Operating Temp. Range	Cooling		°F (°C)	5 ~ 122 (-15 ~ 50)	5 ~ 122 (-15 ~ 50)	5 ~ 122 (-15 ~ 50)	
	Heating		°F (°C)	-22 ~ 75 (-30 ~ 24)	-22 ~ 75 (-30 ~ 24)	-22 ~ 75 (-30 ~ 24)	

NOTE

- Specification may be subject to change without prior notice.
 - Specification comply with EN14511.
- 1) Nominal capacities are based on (Equivalent refrigerant piping : 25ft, Level differences : 0ft);
 - Cooling : Indoor temperature 80°F DB, 67°F WB / Outdoor temperature 95°F DB, 75°F WB
 - Heating : Indoor temperature 70°F DB, 60°F WB / Outdoor temperature 47°F DB, 43°F WB
 - 2) The standard allowed combination ratio of the total rated indoor unit capacity over the rated outdoor unit capacity is 50~130%. Combination ratio of up to 184% is allowed depending on operation mode, minimum operation ratio and connected indoor unit models. DVM Pro 2 design software supports designing over 130% based on system design. Refer to the "Design Procedure & Combination Ratio" section of this document for details
 - 3) If outdoor unit is located in a higher position than indoor unit, level difference is 361ft or under.
 - (If the level difference is higher than 164ft, the PDM kit should be installed)
 - *PDM kit: Pressure Drop Modulation kit
 - 4) These products contain R410A which is fluorinated greenhouse gas.
 - 5) Sound pressure was acquired in a dead room. Thus actual noise level may be different depending on the installation conditions.
 - 6) Sound power level is an absolute value that a sound source generates.
 - Sound pressure level is a relative value, depending on the distance and acoustic environment.
 - Sound values are obtained in an anechoic room.
 - Sound values of multi combination are theoretical values based on sound results of individual installed units.
 - 7) Cooling operation is possible at -15°C(5°F) or higher if satisfied following conditions.
 - (If the outdoor temperature below -5°C(23°F), wind(snow) protection duct must be installed on the suction side of the heat exchanger and at least 50%capacity of the connected indoor units must be operated.) However, if the outdoor unit is installed below the indoor unit, cooling operation is possible only at -5°C(23°F) or higher.
 - 8) External static pressure of the model installed as a combined module follows the external static pressure of each single unit.
- For more information regarding capacity correction, please refer to capacity tables available at www.SamsungHVAC.com/downloads.

2. Specification

DVM S2 (460V)

Model Name				AM360BXVTJH/AA
Outdoor unit module 1				AM120BXVTJH/AA
Outdoor unit module 2				AM120BXVTJH/AA
Outdoor unit module 3				AM120BXVTJH/AA
Outdoor unit module 4				-
Power Supply			Ø, #, V, Hz	3, 3, 460, 60
Mode			-	Heat Pump
Performance	TON		TON	30
	Capacity (Nominal)	Cooling	Btu/h	360,000
		Heating	Btu/h	405,000
	Capacity (Rated)	Cooling	Btu/h	342,000
Heating		Btu/h	386,000	
Maximum number of connectable indoor units			EA	62
Total capacity of the connected Indoor Units		Min.	Btu/h	180,000
		Max.	Btu/h	468,000
Power	Current	MCA	A	-
		MOP	A	-
Casing	Material	Body	-	GI Steel Plate
		Base	-	GI Steel Plate
Heat Exchanger	Type		-	Fin & Tube
	Material	Fin	-	Al
		Tube	-	Cu
	Fin Treatment		-	Anti-corrosion
Compressor	Type		-	Inverter Scroll x 6
	Output		kW x n	(6.67 x 2) x 3
	Model Name		-	(DS4GR7066FV* x 2) x 3
	Oil	Type	-	PVE
		Initial charge	cc x n	(1,100 x 2) x 3
		fl oz x n	(37.2 x 2) x 3	
Fan	Type		-	Propeller
	Discharge direction		-	Top
	Quantity		EA	6
	Air Flow Rate		CFM (m ³ /min)	10,171 x 3 (288 x 3)
	External Static Pressure	Max.	mmAq	-
			Pa	-
		in Wg (Pa)	-	
Fan Motor	Type		-	BLDC Motor
	Output		W x n	(620 x 2) x 3
Piping Connections	Liquid Pipe		Type	Braze connection
			Ø, inch (mm)	3/4 (19.05)
	Gas Pipe		Type	Braze connection
			Ø, inch (mm)	1-5/8 (41.28)
	Heat Insulation		-	Both liquid and gas pipes
	Piping length (ODU-IDU)	Max. [Equiv.]	ft	656 [722]
	Piping length (1st Branch-IDU)	Max.	ft	295
	Total piping length (System)	Max.	ft	3,281
Level difference (ODU in highest position)	Max.	ft	361	
Level difference (IDU in highest position)	Max.	ft	361	
Level difference (IDU-IDU)	Max.	ft	164	

2. Specification

DVM S2 (460V)

Model Name			AM360BXVTJH/AA			
Outdoor unit module 1			AM120BXVTJH/AA			
Outdoor unit module 2			AM120BXVTJH/AA			
Outdoor unit module 3			AM120BXVTJH/AA			
Outdoor unit module 4			-			
Wiring Connections	Transmission Cable	Min.	mm ²	0.75		
		Remark	-	F1, F2		
	Power supply intake		-	Both indoor and outdoor unit		
Refrigerant	Type		-	R410A		
	Factory Charging		lbs (kg)	23.1 x 3 (10.5 x 3)		
Sound	Sound Pressure	Cooling	dB(A)	63.8		
		Heating	dB(A)	63.8		
	Sound Power		dB(A)	83.8		
External Dimension	Net Weight		lbs (kg)	661 x 3 (300 x 3)		
	Shipping Weight		lbs (kg)	699 x 3 (317 x 3)		
	Net Dimensions (WxHxD)			mm	(1,295 x 1,695 x 765) x 3	
				inch	(51 x 66-3/4 x 30-1/8) x 3	
	Shipping Dimensions (WxHxD)			mm	(1,363 x 1,887 x 829) x 3	
		inch	(53-11/16 x 74-5/16 x 32-11/16) x 3			
Operating Temp. Range	Cooling		°F (°C)	5 ~ 122 (-15 ~ 50)		
	Heating		°F (°C)	-22 ~ 75 (-30 ~ 24)		

NOTE

- Specification may be subject to change without prior notice.
 - Specification comply with EN14511.
- 1) Nominal capacities are based on (Equivalent refrigerant piping : 25ft, Level differences : 0ft);
 - Cooling : Indoor temperature 80°F DB, 67°F WB / Outdoor temperature 95°F DB, 75°F WB
 - Heating : Indoor temperature 70°F DB, 60°F WB / Outdoor temperature 47°F DB, 43°F WB
 - 2) The standard allowed combination ratio of the total rated indoor unit capacity over the rated outdoor unit capacity is 50~130%. Combination ratio of up to 184% is allowed depending on operation mode, minimum operation ratio and connected indoor unit models. DVM Pro 2 design software supports designing over 130% based on system design. Refer to the "Design Procedure & Combination Ratio" section of this document for details
 - 3) If outdoor unit is located in a higher position than indoor unit, level difference is 361ft or under.
 - (If the level difference is higher than 164ft, the PDM kit should be installed)
 - *PDM kit: Pressure Drop Modulation kit
 - 4) These products contain R410A which is fluorinated greenhouse gas.
 - 5) Sound pressure was acquired in a dead room. Thus actual noise level may be different depending on the installation conditions.
 - 6) Sound power level is an absolute value that a sound source generates.
 - Sound pressure level is a relative value, depending on the distance and acoustic environment.
 - Sound values are obtained in an anechoic room.
 - Sound values of multi combination are theoretical values based on sound results of individual installed units.
 - 7) Cooling operation is possible at -15°C(5°F) or higher if satisfied following conditions.
 - (If the outdoor temperature below -5°C(23°F), wind(snow) protection duct must be installed on the suction side of the heat exchanger and at least 50%capacity of the connected indoor units must be operated.) However, if the outdoor unit is installed below the indoor unit, cooling operation is possible only at -5°C(23°F) or higher.
 - 8) External static pressure of the model installed as a combined module follows the external static pressure of each single unit.
- For more information regarding capacity correction, please refer to capacity tables available at www.SamsungHVAC.com/downloads.

3. Electric Characteristics

DVM S2 (208~230V)

Capacity TON	Model Name	Power Supply		Module #1				Module #2				Module #3			
		Hz	Voltage	FLA[A]		MCA [A]	MOP [A]	FLA[A]		MCA [A]	MOP [A]	FLA[A]		MCA [A]	MOP [A]
				FAN1	FAN2			FAN1	FAN2			FAN1	FAN2		
6	AM072BXVTFH/AA	60	208-230	4.2	4.2	50.0	60.0	-	-	-	-	-	-	-	-
8	AM096BXVTFH/AA	60	208-230	4.2	4.2	62.0	70.0	-	-	-	-	-	-	-	-
10	AM120BXVTFH/AA	60	208-230	4.2	4.2	76.0	90.0	-	-	-	-	-	-	-	-
12	AM144BXVTFH/AA	60	208-230	4.2	4.2	50.0	60.0	4.2	4.2	50.0	60.0	-	-	-	-
14	AM168BXVTFH/AA	60	208-230	4.2	4.2	50.0	60.0	4.2	4.2	62.0	70.0	-	-	-	-
16	AM192BXVTFH/AA	60	208-230	4.2	4.2	50.0	60.0	4.2	4.2	76.0	90.0	-	-	-	-
18	AM216BXVTFH/AA	60	208-230	4.2	4.2	62.0	70.0	4.2	4.2	76.0	90.0	-	-	-	-
20	AM240BXVTFH/AA	60	208-230	4.2	4.2	76.0	90.0	4.2	4.2	76.0	90.0	-	-	-	-
22	AM264BXVTFH/AA	60	208-230	4.2	4.2	50.0	60.0	4.2	4.2	50.0	60.0	4.2	4.2	76.0	90.0
24	AM288BXVTFH/AA	60	208-230	4.2	4.2	50.0	60.0	4.2	4.2	62.0	70.0	4.2	4.2	76.0	90.0
26	AM312BXVTFH/AA	60	208-230	4.2	4.2	50.0	60.0	4.2	4.2	76.0	90.0	4.2	4.2	76.0	90.0
28	AM336BXVTFH/AA	60	208-230	4.2	4.2	62.0	70.0	4.2	4.2	76.0	90.0	4.2	4.2	76.0	90.0
30	AM360BXVTFH/AA	60	208-230	4.2	4.2	76.0	90.0	4.2	4.2	76.0	90.0	4.2	4.2	76.0	90.0

DVM S2 (460V)

Capacity TON	Model Name	Power Supply		Module #1				Module #2				Module #3			
		Hz	Voltage	FLA[A]		MCA [A]	MOP [A]	FLA[A]		MCA [A]	MOP [A]	FLA[A]		MCA [A]	MOP [A]
				FAN1	FAN2			FAN1	FAN2			FAN1	FAN2		
6	AM072BXVTJH/AA	60	460	2.1	2.1	25.0	30.0	-	-	-	-	-	-	-	-
8	AM096BXVTJH/AA	60	460	2.1	2.1	31.0	35.0	-	-	-	-	-	-	-	-
10	AM120BXVTJH/AA	60	460	2.1	2.1	38.0	45.0	-	-	-	-	-	-	-	-
12	AM144BXVTJH/AA	60	460	2.1	2.1	25.0	30.0	2.1	2.1	25.0	30.0	-	-	-	-
14	AM168BXVTJH/AA	60	460	2.1	2.1	25.0	30.0	2.1	2.1	31.0	35.0	-	-	-	-
16	AM192BXVTJH/AA	60	460	2.1	2.1	25.0	30.0	2.1	2.1	38.0	45.0	-	-	-	-
18	AM216BXVTJH/AA	60	460	2.1	2.1	31.0	35.0	2.1	2.1	38.0	45.0	-	-	-	-
20	AM240BXVTJH/AA	60	460	2.1	2.1	38.0	45.0	2.1	2.1	38.0	45.0	-	-	-	-
22	AM264BXVTJH/AA	60	460	2.1	2.1	25.0	30.0	2.1	2.1	25.0	30.0	2.1	2.1	38.0	45.0
24	AM288BXVTJH/AA	60	460	2.1	2.1	25.0	30.0	2.1	2.1	31.0	35.0	2.1	2.1	38.0	45.0
26	AM312BXVTJH/AA	60	460	2.1	2.1	25.0	30.0	2.1	2.1	38.0	45.0	2.1	2.1	38.0	45.0
28	AM336BXVTJH/AA	60	460	2.1	2.1	31.0	35.0	2.1	2.1	38.0	45.0	2.1	2.1	38.0	45.0
30	AM360BXVTJH/AA	60	460	2.1	2.1	38.0	45.0	2.1	2.1	38.0	45.0	2.1	2.1	38.0	45.0

NOTE

- Voltage Tolerance is $\pm 10\%$
- Maximum allowable voltage between phases is 2%
- Refer to module combination table for independent units information
- FLA : Full Load Ampere
- MCA : Minimum Circuit Ampere (A)
- MOP : Maximum Overcurrent Protective Device (A)

4. Dimensional Drawing

Outdoor unit

• AM072/096/120BXVTFH/AA, AM072/096/120BXVTJH/AA

Unit: mm (inches)

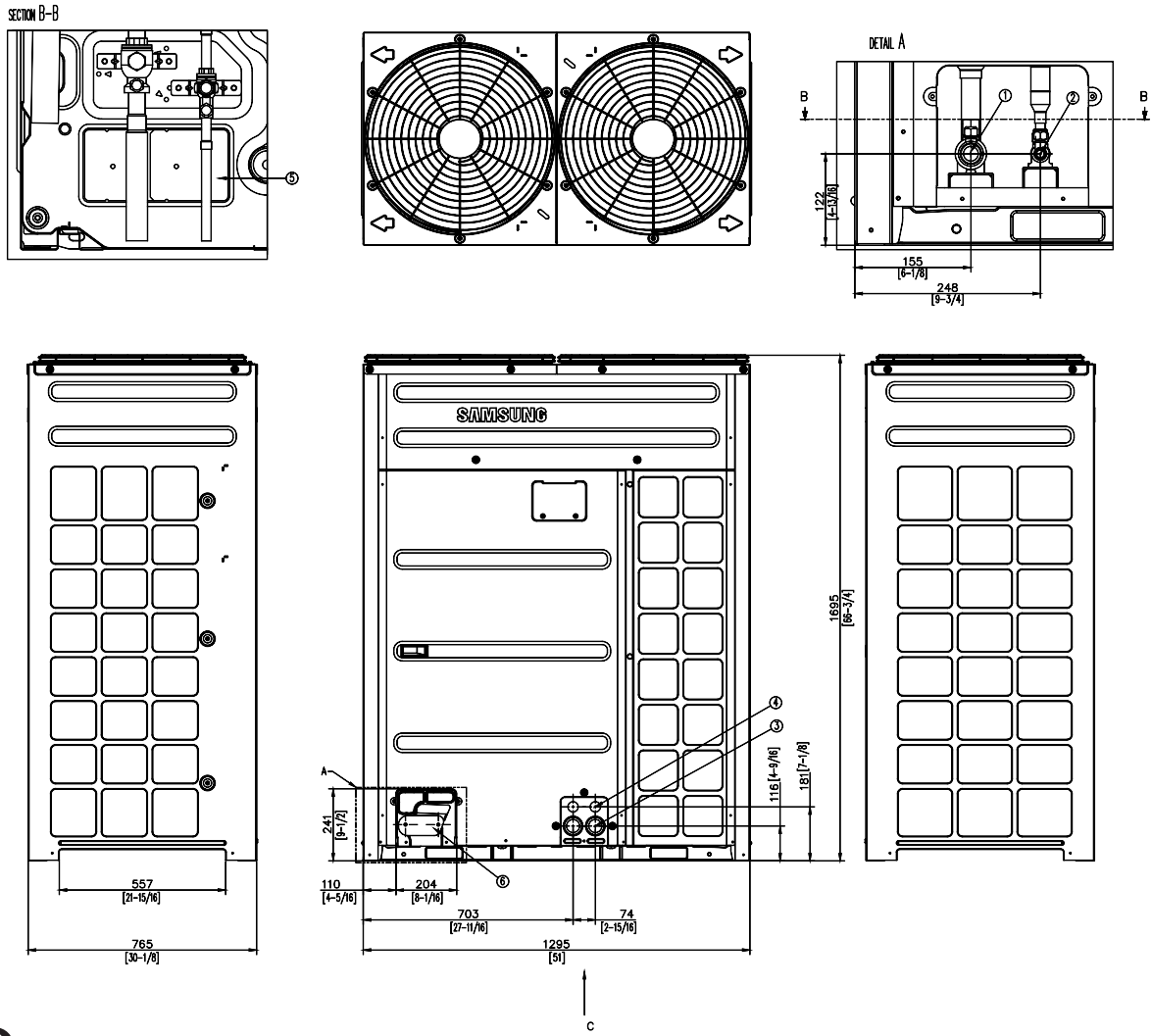

NOTE

- 1 Detail A and SECTION B-B indicate the dimension after fixing the attached piping.
- 2 Item 3-6: Knock-out hole
- 3 View C indicate the dimension of knock-out hole (bottom)
- 4 Pipe [Ø, mm(inch)]: Brazing connection

kBtu	Liquid pipe	Gas pipe
072	3/8 (9.52)	3/4 (19.05)
096	3/8 (9.52)	7/8 (22.22)
120	1/2 (12.70)	1-1/8 (28.58)

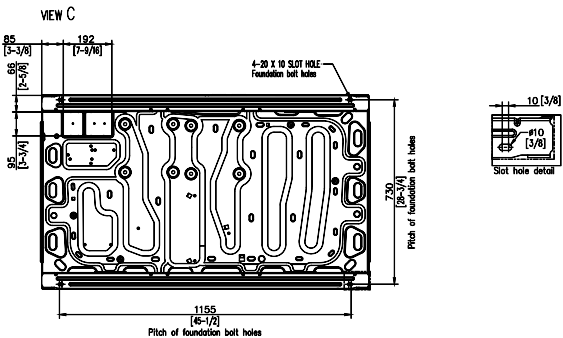

NO	Table of descriptions	Remark	NO	Table of descriptions	Remark
1	Gas Ref.pipe	See NOTE 4.	5	Knock-out Hole for Ref.Piping (bottom)	
2	Liquid Ref.pipe	See NOTE 4.	6	Knock-out Hole for Ref.Piping (front)	
3	Power wiring conduit	Ø44			
4	Communication wiring conduit	Ø34			

5. Center of Gravity

Outdoor unit

Unit: mm (inches)

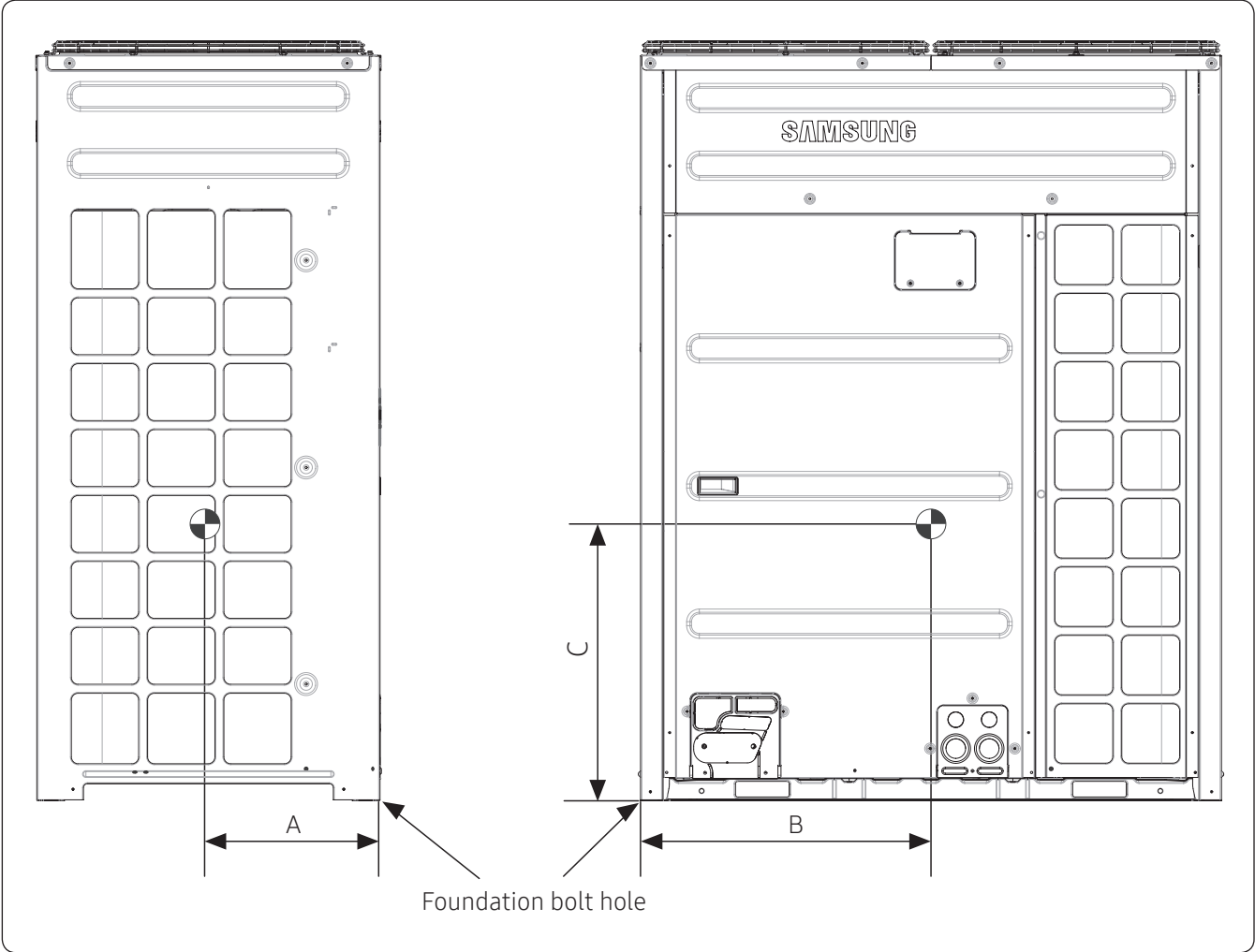

Model	A	B	C
AM072BXVT*H/AA AM096BXVT*H/AA AM120BXVT*H/AA	324 [12 - 3/4]	520 [20 - 1/2]	678 [26 - 11/16]

6. Electrical Wiring Diagrams

Outdoor unit

AM072BXVTFH/AA, AM072/096/120BXVTJH/AA

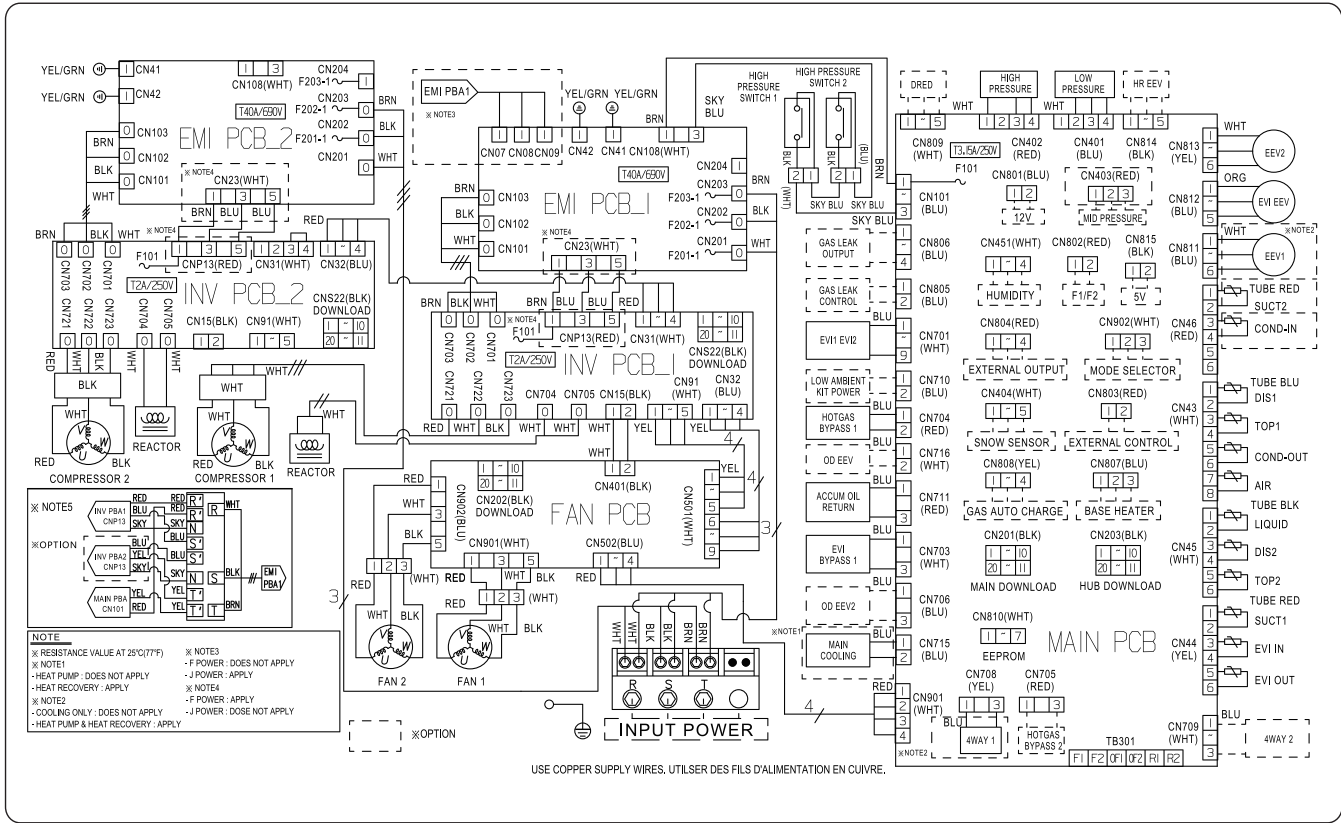

INV PCB1	Printed circuit board (inverter1)	EEV1	Electronic expansion valve 1	HOTGAS1 BYPASS V/V	Solenoid valve (Hot Gas Bypass1)
INV PCB2	Printed circuit board (inverter2)	EEV2	Electronic expansion valve 2	EVI BYPASS1 V/V	Solenoid valve (EVI BYPASS)
EMI PCB1	Printed circuit board (emi1)	EVI-OUT(10K)	Thermistor (EVI-out_10kohm)	ACCUM OIL RETURN V/V	Solenoid valve (Accumulator Oil Return)
EMI PCB2	Printed circuit board (emi2)	EVI-IN(10K)	Thermistor (EVI-in_10kohm)	4WAY1 V/V	Solenoid valve (4 Way valve1)
FAN PCB	Printed circuit board (fan motor)	SUCT1(10K)	Thermistor (Suction Temp.1_10Kohm)	4WAY2 V/V	Solenoid valve (4 Way valve2)
MAIN PCB	Printed circuit board (main)	SUCT2(10K)	Thermistor (Suction Temp.2_10Kohm)	MAIN COOLING	Solenoid valve (Main cooling)
COMPRESSOR1	Motor (compressor1)	COND IN(10K)	Thermistor (Cond In Temp._10Kohm)	HOTGAS2 BYPASS V/V	Solenoid valve (Hot Gas Bypass2)
COMPRESSOR2	Motor (compressor2)	AIR(10K)	Thermistor (Ambient Temp._10Kohm)	OD EEV V/V	Electronic expansion valve (Outdoor EEV)
FAN1	Motor (fan1)	COND(10K)	Thermistor (Cond Out Temp._10Kohm)	F101	FUSE (INV PCB)
FAN2	Motor (fan2)	TOP1(200K)	Thermistor (Compressor Top 1_200Kohm)	690V/40A	FUSE (EMI PCB)
EVI V/V1	Solenode valve (EVI1)	TOP2(200K)	Thermistor (Compressor Top 2200Kohm)	MODE SELECTOR	Connector (Remote switching cool/heat selector)
EVI V/V2	Solenode valve (EVI2)	DIS1(200K)	Thermistor (Discharge Temp.1_200Kohm)	EXTERNAL CONTROL	Connector (Output EXTERNAL CONTROL)
EVI EEV	Electronic expansion valve (EVI)	DIS2(200K)	Thermistor (Discharge Temp.2_200Kohm)	EXTERNAL OUTPUT	Connector (Output EXTERNAL)
SNOW SENSOR	SNOW SENSOR	LIQUID(10K)	Thermistor (Liquid Tube Temp._10Kohm)		

NOTE

- This wiring diagram applies only to the outdoor unit.
- Colors BLK: black, RED: red, BLU: blue, WHT: white, YEL: yellow, BRN: brown, SKY: skyblue
- When operating, don't shortcircuit the protection device (High Pressure switch)
- For connection wiring indoor-outdoor transmission F1-F2, outdoor_outdoor transmission OF1-OF2, refer to the installation manual.
- Protective earth(screw), : connector, : The wire quantity

6. Electrical Wiring Diagrams

Outdoor unit

AM096/120BXVTFH/AA

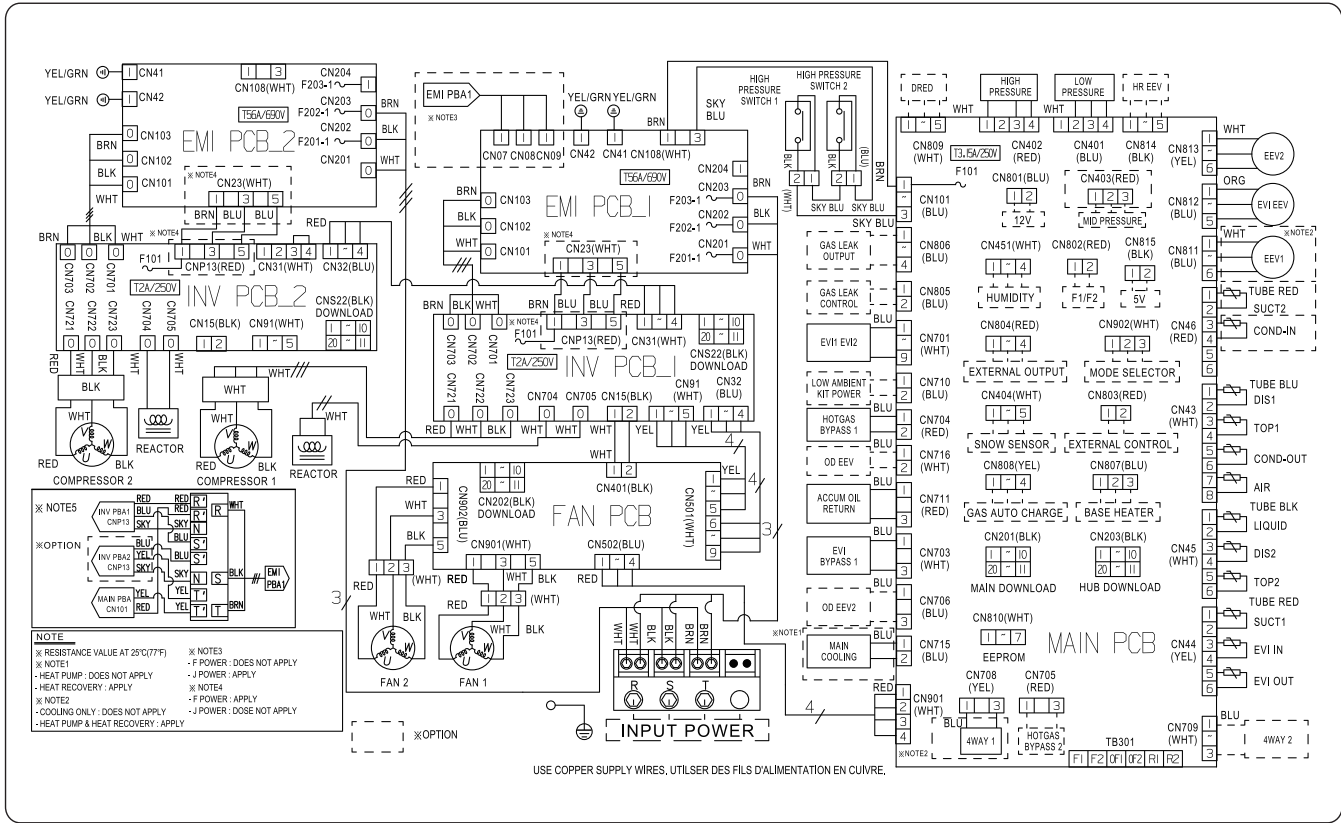

INV PCB1	Printed circuit board (inverter1)	EEV1	Electronic expansion valve 1	HOTGAS1 BYPASS V/V	Solenoid valve (Hot Gas Bypass1)
INV PCB2	Printed circuit board (inverter1)	EEV2	Electronic expansion valve 2	EVI BYPASS1 V/V	Solenoid valve (EVI BYPASS)
EMI PCB1	Printed circuit board (inverter2)	EVI-OUT(10K)	Thermistor (EVI-out_10kohm)	ACCUM OIL RETURN V/V	Solenoid valve (Accumulator Oil Return)
EMI PCB2	Printed circuit board (emi1)	EVI-IN(10K)	Thermistor (EVI-in_10kohm)	4WAY1 V/V	Solenoid valve (4 Way valve1)
FAN PCB	Printed circuit board (emi2)	SUCT1(10K)	Thermistor (Suction Temp.1_10Kohm)	4WAY2 V/V	Solenoid valve (4 Way valve2)
FAN PCB	Printed circuit board (fan motor)	SUCT1(10K)	Thermistor (Suction Temp.2_10Kohm)	MAIN COOLING	Solenoid valve (Main cooling)
MAIN PCB	Printed circuit board (main)	SUCT2(10K)	Thermistor (Cond In Temp._10Kohm)	HOTGAS2 BYPASS V/V	Solenoid valve (Hot Gas Bypass2)
COMPRESSOR1	Motor (compressor1)	COND IN(10K)	Thermistor (Ambient Temp._10Kohm)	OD EEV V/V	Electronic expansion valve (Outdoor EEV)
COMPRESSOR2	Motor (compressor2)	AIR(10K)	Thermistor (Cond Out Temp._10Kohm)	F101	FUSE (INV PCB)
FAN1	Motor (fan1)	COND(10K)	Thermistor (Compressor Top 1_200Kohm)	690V/56A	FUSE (EMI PCB)
FAN2	Motor (fan2)	TOP1(200K)	Thermistor (Compressor Top 2_200Kohm)	MODE SELECTOR	Connector (Remote switching cool/heat selector)
EVI V/V1	Solenoid valve (EVI1)	TOP2(200K)	Thermistor (Discharge Temp.1_200Kohm)	EXTERNAL CONTROL	Connector (Output EXTERNAL CONTROL)
EVI V/V2	Solenoid valve (EVI2)	DIS1(200K)	Thermistor (Discharge Temp.2_200Kohm)	EXTERNAL OUTPUT	Connector (Output EXTERNAL)
EVI EEV	Electronic expansion valve (EVI)	DIS2(200K)	Thermistor (Liquid Tube Temp._10Kohm)		
SNOW SENSOR	SNOW SENSOR	LIQUID(10K)	Thermistor (Liquid Tube Temp._10Kohm)		

NOTE

- This wiring diagram applies only to the outdoor unit.
- Colors BLK: black, RED: red, BLU: blue, WHT: white, YEL: yellow, BRN: brown, SKY: skyblue
- When operating, don't shortcircuit the protection device (High Pressure switch)
- For connection wiring indoor-outdoor transmission F1-F2, outdoor_outdoor transmission OF1-OF2, refer to the installation manual.
- Protective earth(screw), : connector, : The wire quantity

7. Sound Data

Sound Pressure level

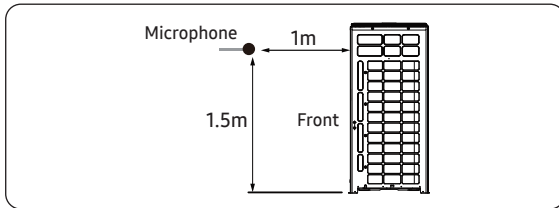

Unit: dB(A)

Model	Cooling	Silent 1	Silent 2	Silent 3
AM072BXVTFH/AA	55	53	51	49
AM096BXVTFH/AA	57	55	53	49
AM120BXVTFH/AA	59	57	53	49

• NC Curve

1) AM072BXVTFH/AA

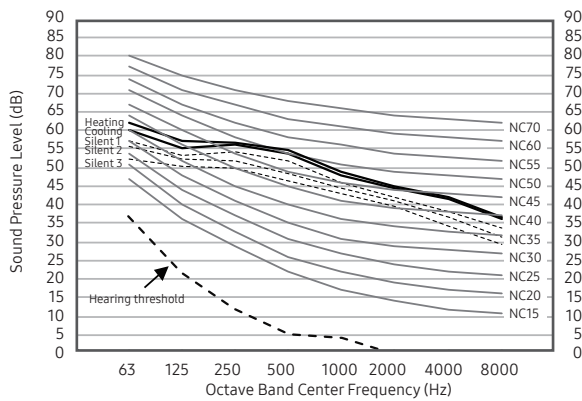

2) AM096BXVTFH/AA

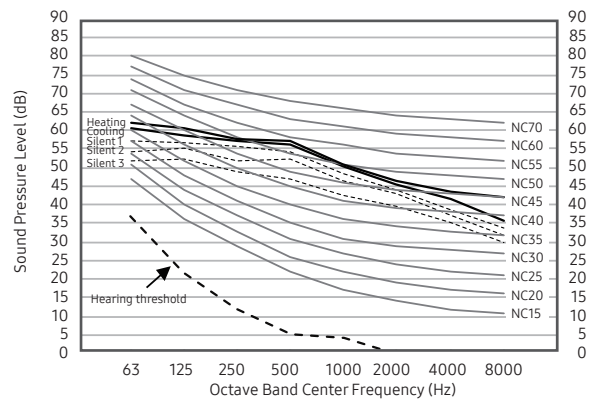

3) AM120BXVTFH/AA

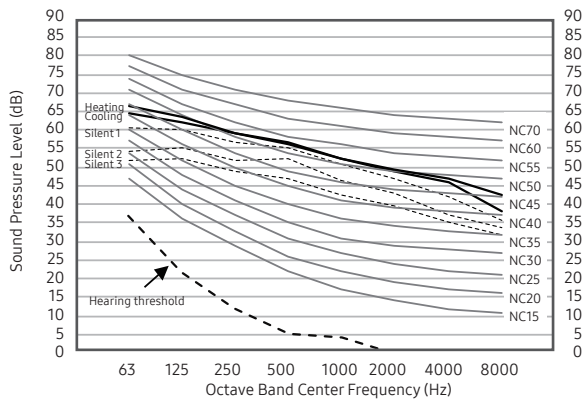

NOTE

- Specifications may be subject to change without prior notice.
 - Sound pressure level is obtained in an anechoic room.
 - Sound pressure level is a relative value, depending on the distance and acoustic environment.
 - Sound pressure level may differ depending on operation condition.
 - dBA = A-weighted sound pressure level
 - Reference acoustic pressure 0 dB = 20μPa

7. Sound Data

Sound Pressure level

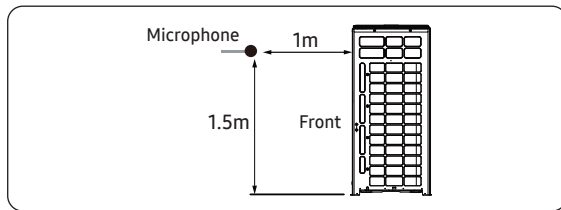

Unit: dB(A)

Model	Cooling	Silent 1	Silent 2	Silent 3
AM072BXVTJH/AA	55	53	51	49
AM096BXVTJH/AA	57	55	53	49
AM120BXVTJH/AA	59	57	53	49

• NC Curve

1) AM072BXVTJH/AA

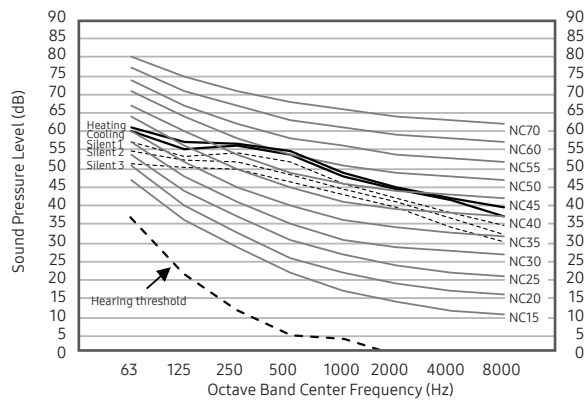

3) AM096BXVTJH/AA

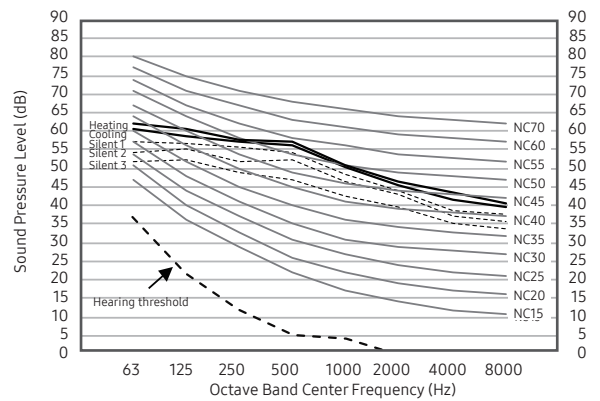

3) AM120BXVTJH/AA

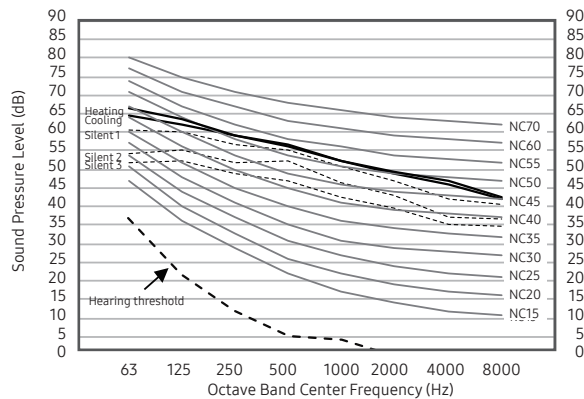

NOTE

- Specifications may be subject to change without prior notice.
 - Sound pressure level is obtained in an anechoic room.
 - Sound pressure level is a relative value, depending on the distance and acoustic environment.
 - Sound pressure level may differ depending on operation condition.
 - dBA = A-weighted sound pressure level
 - Reference acoustic pressure 0 dB = 20μPa

7. Sound Data

Sound Power level

Unit: dB(A)

Model	Cooling
AM072BXVTFH/AA	74
AM096BXVTFH/AA	77
AM120BXVTFH/AA	79

- NC Curve

1) AM072BXVTFH/AA

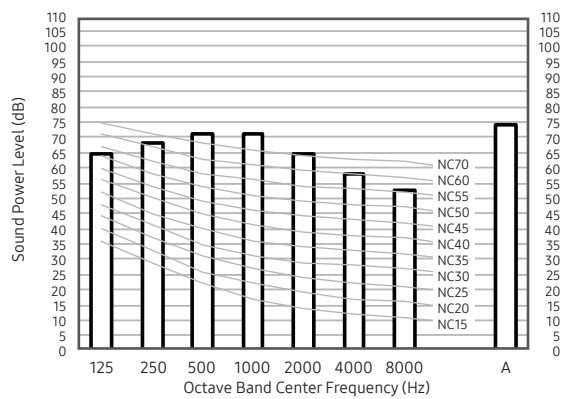

2) AM096BXVTFH/AA

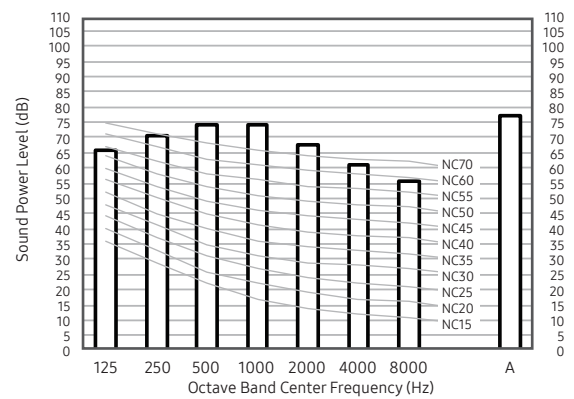

3) AM120BXVTFH/AA

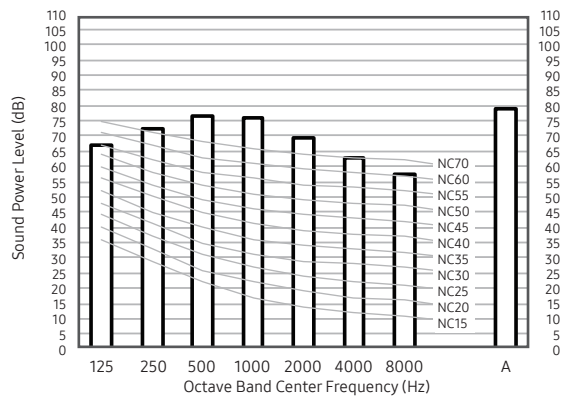

NOTE

- Specifications may be subject to change without prior notice.
 - Sound power level is an absolute value that a sound source generates.
 - dBA = A-weighted sound power level.
 - Reference power : 1pW.
 - Measured according to ISO 3741.

7. Sound Data

Sound Power level

Unit: dB(A)

Model	Cooling
AM072BXVTJH/AA	74
AM096BXVTJH/AA	77
AM120BXVTJH/AA	79

- NC Curve

1) AM072BXVTJH/AA

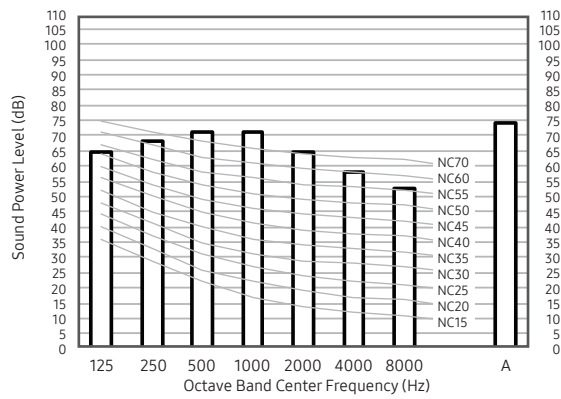

2) AM096BXVTJH/AA

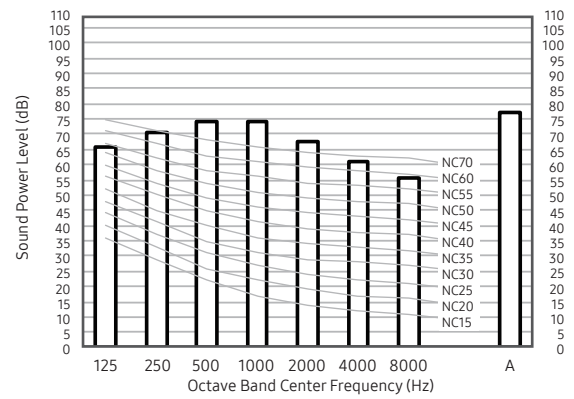

3) AM120BXVTJH/AA

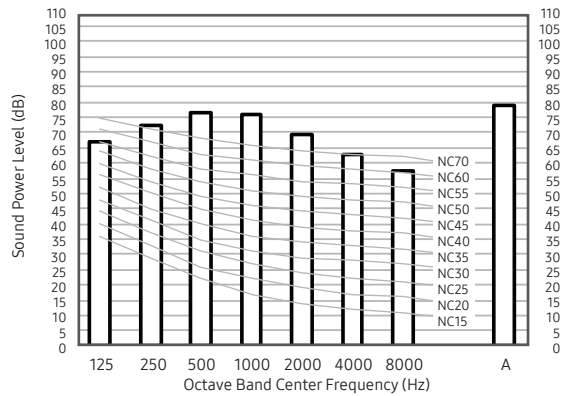

NOTE

- Specifications may be subject to change without prior notice.
 - Sound power level is an absolute value that a sound source generates.
 - dBA = A-weighted sound power level.
 - Reference power : 1pW.
 - Measured according to ISO 3741.

8. Operation Range

Outdoor unit

Cooling

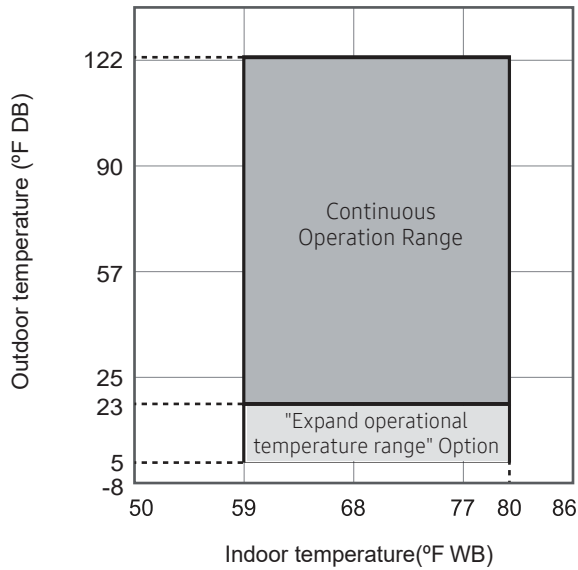

Heating

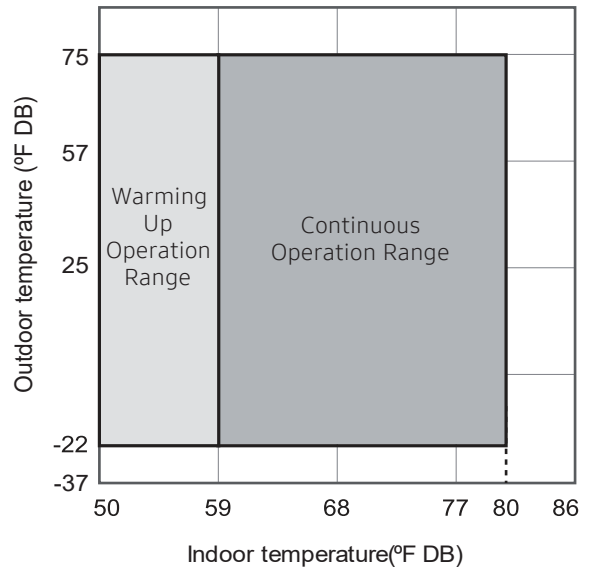

- (1) The operating range is shown in these figures
- (2) The assumed installation conditions are as follows
 - Outdoor units and indoor units combination
 - The Pipe length(including elbow) is 5m (16.4ft)
 - The Level difference is 0m
- (3) In the low temperature expansion option application, the cooling operating is possible under expand operational range only for HR system
- (4) In case of heating mode, operating is possible under warming up operation range. However continuous operating is impossible due to a protection control

8. Operation Range

Outdoor unit

Defrosting correction factor

The heating capacity tables do not take account of the reduction in capacity, when frost has accumulated or while the defrosting operation is in progress.

The capacity values, which take these factors into account, in other words, the integrated heating capacity values, can be calculated as follows :

Formula : $A = B \times C$

Integrated heating capacity = A

Value given in table of capacity characteristics = B

Integrating correction factor for frost accumulation (kW) = C

Outdoor temperature (°F, DB)	14	17.6	21.2	24.8	28.4	32	37.4	41	44.6
Capacity coefficient	0.99	0.98	0.96	0.95	0.91	0.88	0.86	0.91	1.00

Capacity coefficient of outdoor unit on defrost operation

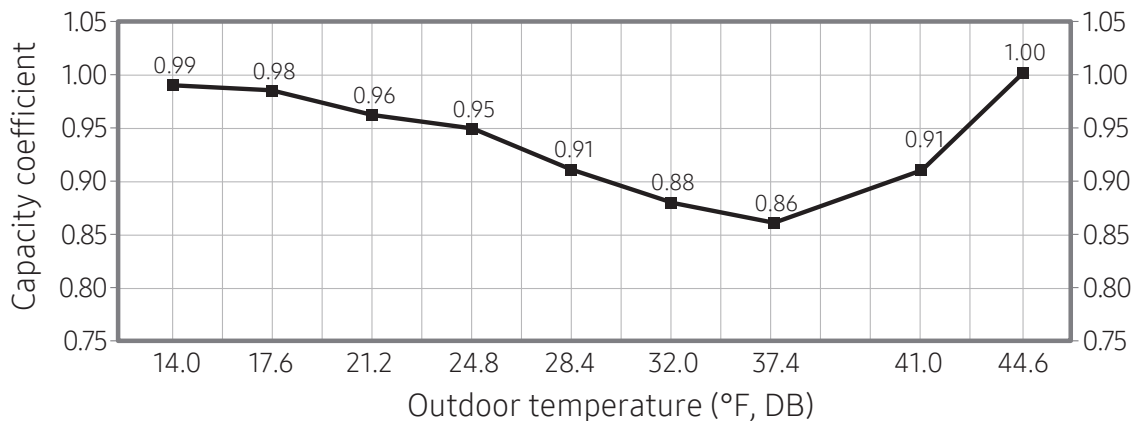

On heating operation, frost can be formed on heat exchanger according to outdoor temperature.

(Frost on heat exchanger results in decreasing the performance.)

To remove frost on heat exchanger of outdoor unit, defrost operation is carried out periodically.

During defrost operation, capacity of outdoor unit may decrease.

The decrement is not considered to the individual capacity tables.

This figure shows an effect of intelligence defrost operation

It is actually the frost occurrence section from 0 °C(32 °F) or less.

Since the outdoor temperature over 0 °C(32 °F), the heating performance is the same before and after applying intelligence defrost operation

In outdoor conditions below 0 °C(32 °F), frost conditions reflect the actual entering the defrost operation because heating performance is improved

9. Piping Diagram

Outdoor unit

AM072BXVT*H/AA, AM096BXVT*H/AA, AM120BXVT*H/AA

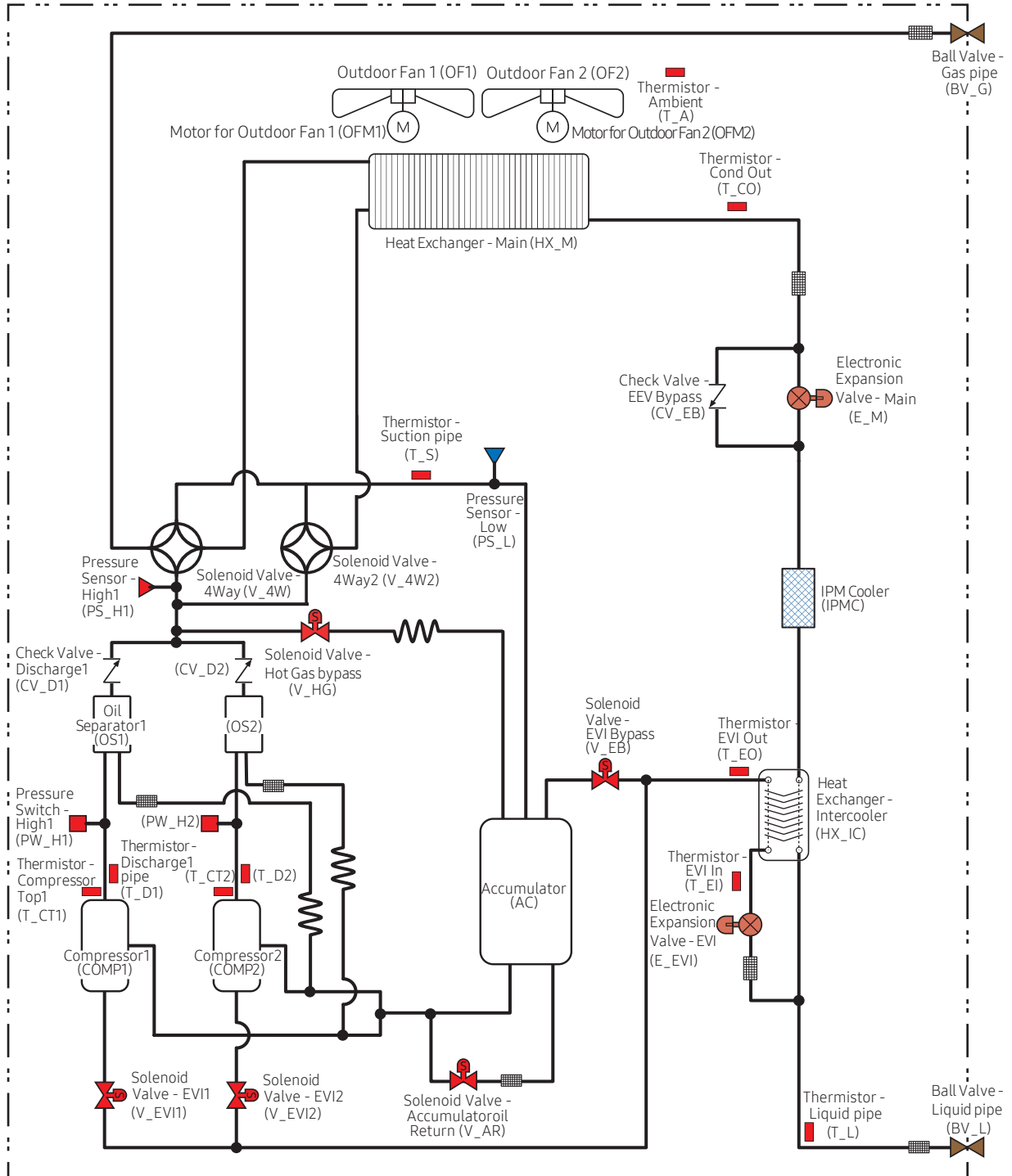

10. Installation

Choosing the installation location

Outdoor unit location requirements

Decide the installation location, with the consideration of the following conditions, under user's approval.

- Place where hot discharge air or noise from the outdoor unit may not disturb the neighbor (Especially in residential areas, keep the operation hours in mind.)
- Place where structure can bear the weight and vibration of the outdoor unit.
- Place with flat surface where rainwater does not settle or leak.
- Place where it is not exposed to strong wind.
- Well ventilated place with sufficient service place for repairs and maintenance. (Discharge duct must be purchased separately in your local market.)
- Place where you can connect the refrigerant pipes between indoor and outdoor units within allowable distance.
- Place where it allows easy waterproofing and draining work for the condensation water generated from the outdoor unit during heating operation.
- Place where there is no risk of inflammable gas leakage.
- Place where there is no direct influence of snow or rain.
- Place where a large amount of water generated by external environment does not directly affect the top of the outdoor unit

Installation Guide at the seashore

Make sure to follow below guides when installing at the seashore.

- 1 Do not install the product in a place where it is directly exposed to sea water and sea breeze.
 - Make sure to install the product behind a structure (such as building) that can block sea breeze.
 - Even when it is inevitable to install the product in seashore, make sure that product is not directly exposed to sea breeze by installing a protection wall.

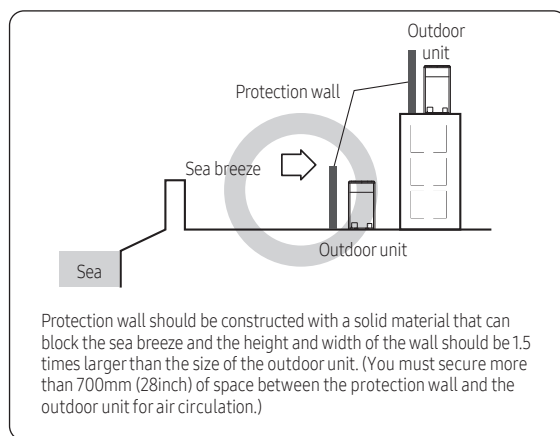

- 2 Consider that the salinity particles clinging to the external panels should be sufficiently washed out.
- 3 Because the residual water at the bottom of the outdoor unit significantly promotes corrosion, make sure that the slope does not disturb drainage.
 - Keep the floor level so that rain does not accumulate.
 - Be careful not to block the drain hole due to foreign substance
- 4 When product is installed in seashore, periodically clean it with water to remove attached salinity.
- 5 Make sure to install the product in a place that provides smooth water drainage. Especially, ensure that the base part has good drainage.
- 6 If the product is damaged during the installation or maintenance, make sure to repair it

10. Installation

Choosing the installation location

7 Check the condition of the product periodically.

- Check the installation site every 3 months and perform anticorrosion treatment such as R-Pro supplied by SAMSUNG (Code : MOK-220SA) or commercial water repellent grease and wax, etc., based on the product condition.
- When the product is to be shut down for a long period of time, such as off-peak hours, take appropriate measures like covering the product.

8 If the product installed within 500m (1640ft) of seashore, special anticorrosion treatment is required.

※ Please contact your local SAMSUNG representative for further details.

If you cannot find a proper location to install the outdoor unit, consult with an expert or specialty store.

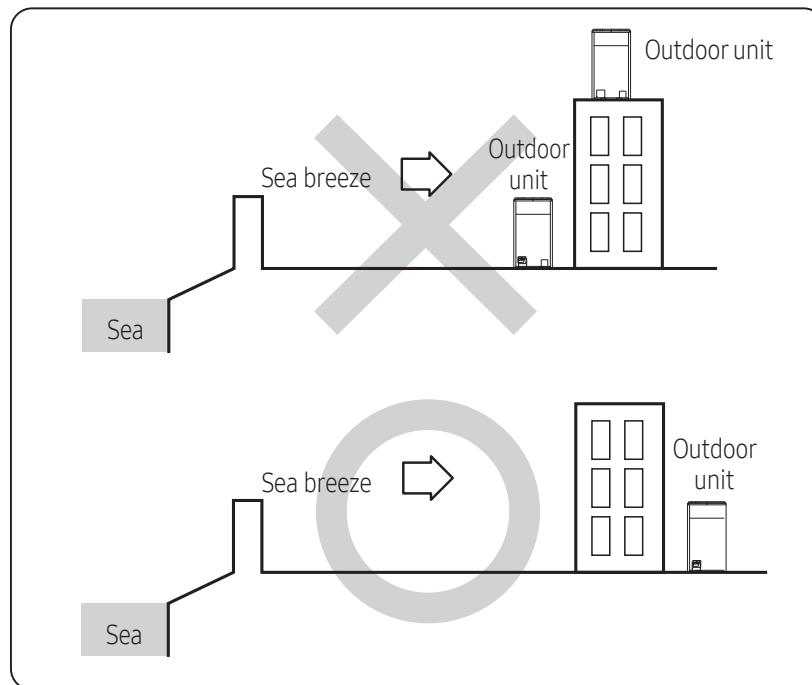

CAUTION

- System air conditioner may cause static noise when listening to AM stations. Therefore, select an installation location for indoor unit where electrical wiring can be done while keeping certain distance from a radio, computer and stereo equipment.
 - Especially, keep the unit at least 3m (9.84ft) away from the electrical equipment in an area with weak electromagnetic waves and put the main power cable and communication cables in a separately installed protection tube.
 - Make sure that there is no equipment that generates electromagnetic waves. If not electromagnetic waves may cause problem to the control systems which may lead to air conditioner malfunction. (Example: Remote control sensor of the indoor unit may not receive the signal very well, due to ballast stabilizer of the lighting equipment.)
- In regions with heavy snowfall, make sure to install the outdoor unit where there is no concerns of direct snowfall on the outdoor unit. Also, build higher base support so that accumulated snow does not block the air inlet or the heat exchanger.
- R-410A refrigerant is a safe, nontoxic and nonflammable refrigerant. However, if the place holds any concerns for exceeding dangerous level of refrigerant concentration in case of refrigerant leakage, extra ventilation system is required.
- When you install the outdoor unit in high places such as a roof, install fence or guardrail around it. When there is no fence or guardrail, service person could fall.

10. Installation

Choosing the installation location

- Do not install the product in places where corrosive gases such as sulfur oxides, ammonia, and sulfur dioxide are produced. (e.g. Toilet outlet, ventilation opening, sewage works, dyeing complex, cattle shed, sulfuric hot spring, nuclear power plant, ship etc.) When installing the product in those places, contact an installation specialty store as the copper pipe and brazing part will need additional corrosion proof or anti-rust additive to prevent corrosion.
- Make sure not to keep any inflammable materials (such as wooden materials, oil etc.) around the outdoor unit. When there's fire, those inflammable material will easily catch the fire and may pass it on to the product.
- Depending on the condition of power supply, unstable power or voltage may cause malfunction of the parts or control system. (At the ship or places using power supply from electric generator...etc)
- Make sure to install MCU when using HR products.
- When you select the location to install the MCU, the location is far away from indoor rooms because the refrigerant running of MCU may create noise.

Outdoor unit space requirements

- Space requirement was decided based on following conditions; Cooling mode, outdoor temperature of 35°C (95 °F). Larger space is required if the outdoor temperature is higher than 35°C (95 °F) or if the place is heated easily by quantity of solar radiation.
- When you secure installation space, consider path for people and the direction of the wind.
- Secure installation space as shown in the below illustration, considering ventilation and the service space.
- If the installation space is narrow, installer or other worker may get injured during work and may also cause problem to the product.
- If you install multiple number of outdoor units in one space, make sure to secure enough ventilation space if there's any walls around the product that may disturb the air flow. If enough ventilation space is not secured, product may malfunction.
- You may install the outdoor units with 20mm (0.78inch) of space between the product, but product's performance may decrease depending on the installation environment.

Single installation

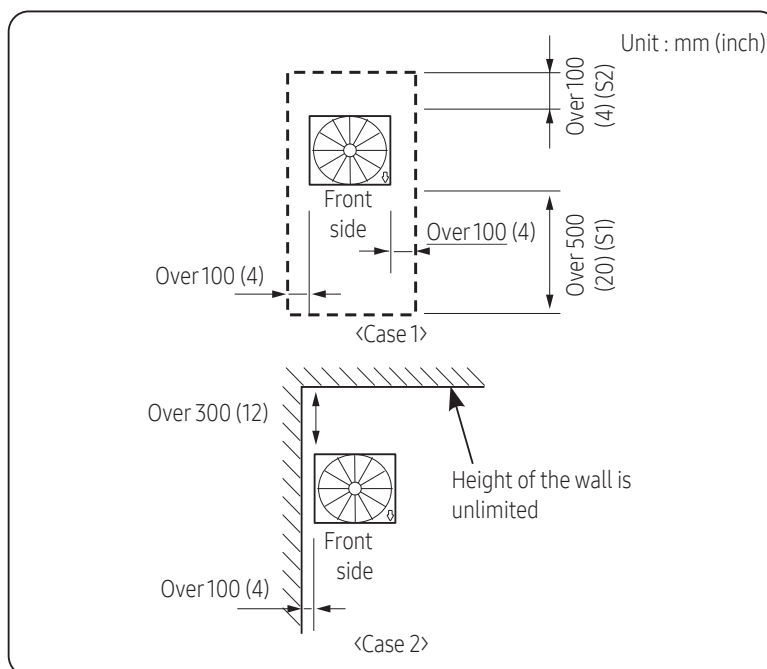

10. Installation

Choosing the installation location

Module installation

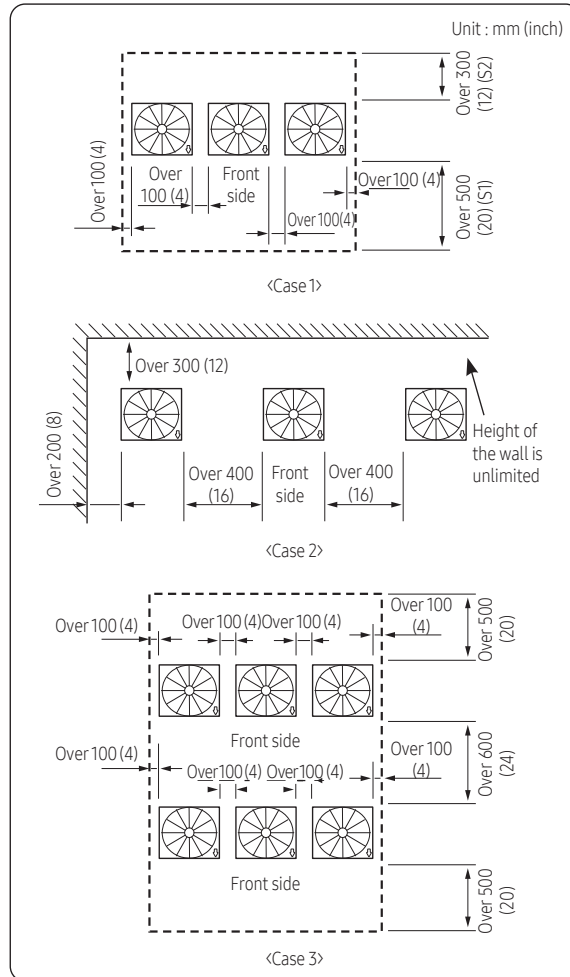

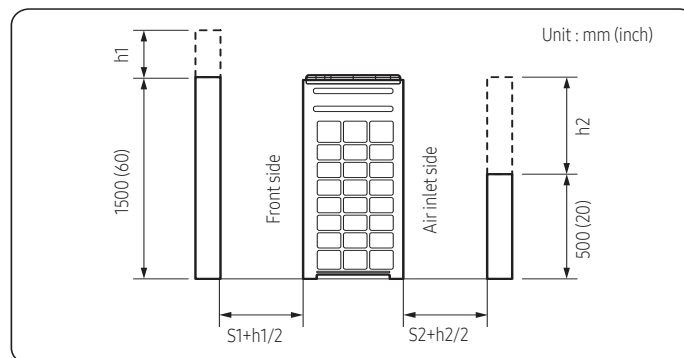

- For <Case 1> or <Case 3>
 - Height of the wall on the front side should not be higher than 1500mm (60inch).
 - Height of the wall on the air inlet side should not be higher than 500mm (20inch).
 - Height of the wall on the side is not limited.
 - If the height of the wall exceeds by certain value (h_1 , h_2), additional clearance $[(h_1)/2, (h_2)/2]$: Half of the exceeded height] should be added to the service space (S_1 , S_2).



10. Installation

Preparing materials and tools

- You must keep the installation manual until the installation is finished.
- Hand over the installation manual to the customer after finishing the installation.

Installation manual (1)	Packing socket (1)
	

※ Certain models are supplied with a packing socket. The socket type may differ, depending on the model.

Optional accessories

- Following optional accessories are needed for connecting pipes between the indoor and outdoor units.

Classification	Model Name	Specification	
		MBH	kW
Y-Joint	MXJ-YA1509M	51 and below	15.0 and below
	MXJ-YA2512M	52~136	15.1 ~40.0
	MXJ-YA2812M	137~154	40.1 ~45.0
	MXJ-YA2815M	155~240	45.1 ~70.3
	MXJ-YA3419M	241~336	70.4 ~98.4
	MXJ-YA4119M	337~461	98.5 ~135.2
	MXJ-YA4422M	Over 461	Over 135.2

Classification	Model Name	Specification	
		MBH	kW
Y-Joint (Only H/R)	MXJ-YA1500M	76 and below	22.4 and below
	MXJ-YA2500M	77~240	22.5 ~70.3
	MXJ-YA3100M	241~461	70.4 ~135.2
	MXJ-YA3800M	Over 461	Over 135.2
Distribution header	MXJ-HA2512M	154 and below (for 4 rooms)	45.0 and below (for 4 rooms)
	MXJ-HA3115M	240 and below (for 8 rooms)	70.3 and below (for 8 rooms)
	MXJ-HA3819M	241 ~ 461 (for 8 rooms)	70.4 ~ 135.2 (for 8 rooms)
Y-Joint - Outdoor unit	MXJ-TA3819M	461 and below	135.2 and below
	MXJ-TA4422M	Over 461	Over 135.2
Y-Joint (Only H/R) - Outdoor unit	MXJ-TA3100M	461 and below	135.2 and below
	MXJ-TA3800M	Over 461	Over 135.2

- ※ If you use an indoor unit with no internal EEV(Electric Expansion Valve), you will need an EEV kit.
- ※ Only use the genuine accessories listed in above table and do not use imitated accessories.

10. Installation

Outdoor unit installation

WARNING

- Make sure to remove the wooden pallet before installing the outdoor unit. If you do not remove the wooden pallet, there is risk of fire during welding the pipes. If the outdoor unit is installed with wooden pallet on, and it was used for long period time, wooden palette may break and cause electrical hazard or high pressure may damage the pipes.
 - ※ Fix an outdoor unit firmly on the base ground with anchor bolts.
 - ※ Manufacturer is not responsible for the damage occurred by not following the installation standards.
- 1 Make sure that the height of the base ground is 200mm (8inch) or higher to protect the outdoor unit from rain water or othe external conditions. Also, install a draining pit around the base ground and connect the drain pipe to the drainage.
 - 2 Considering the vibration and weight of the outdoor unit, strength of the base ground must be strong to prevent noise and the top surface of it should be flat.
 - 3 Base ground should be 1.5 times larger than the bottom of the outdoor unit.
 - 4 Outdoor unit must be fixed firmly so that it can withstand the wind speed of 30m/s. If you cannot fix the outdoor unit on the base ground, fix it by side or use extra structure.
 - 5 In heating operation, defrost water may form so you must really care about the drainage and waterproofing the floor. To prevent defrost water from stagnating or freezing, construct a drainage with over 1/50 slope. (Ice may form on the floor in winter season.)
 - 6 It is necessary to add wire mesh or steel bar during concrete construction for the base ground to prevent damages or cracks.
 - 7 When installing multiple outdoor units at the same place, construct an H beam or an anti-vibration frame on the base ground to install the outdoor unit.
 - 8 After installing an H beam or an anti-vibration frame, apply corrosion protection and other necessary coating.
 - 9 When concrete construction for outdoor unit installation is completed, install an anti-vibration pad (t=20mm/0.78inch or more) or an anti-vibration frame to prevent vibration of the outdoor unit from transferring to the base ground.
 - 10 Place the outdoor unit on an H beam or an anti-vibration frame and fix it with the bolt, nut and washer. (The bearing force has to be over 3.5kN)

Base ground construction

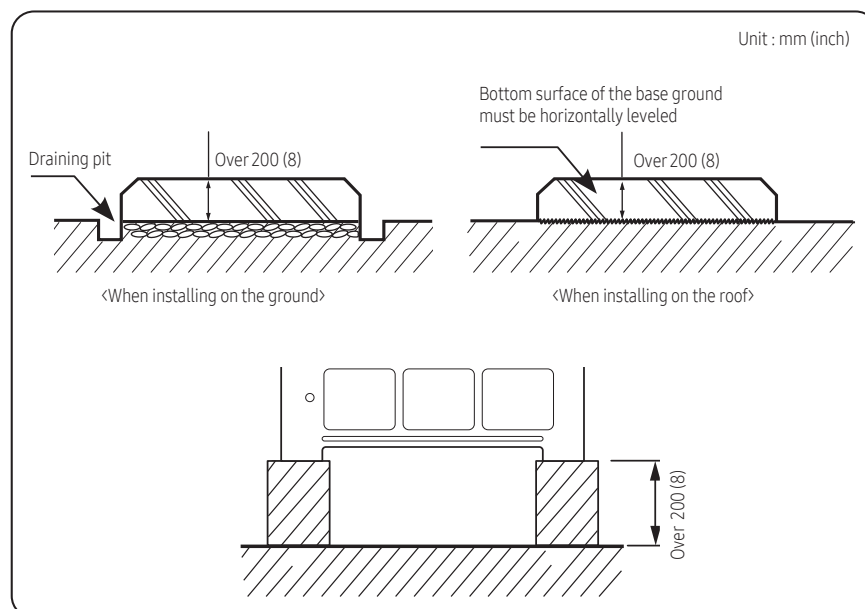

10. Installation

Outdoor unit installation

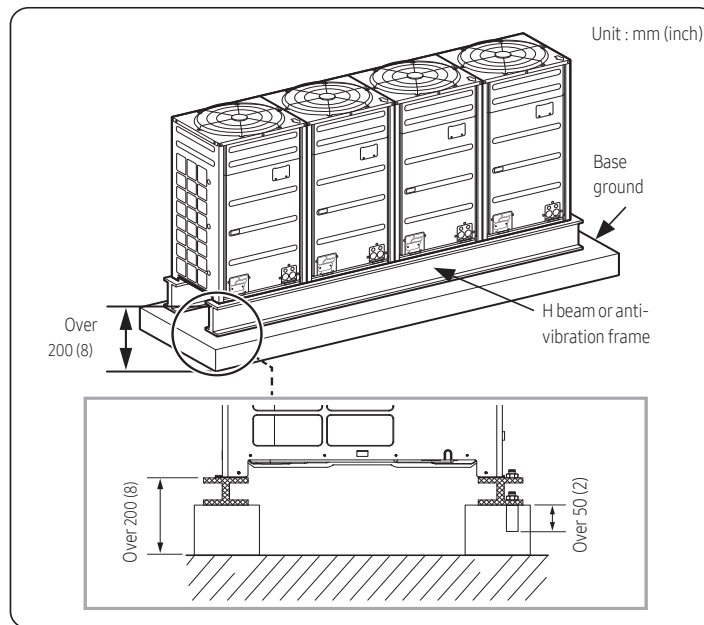

Outdoor unit base mount and anchor bolt position

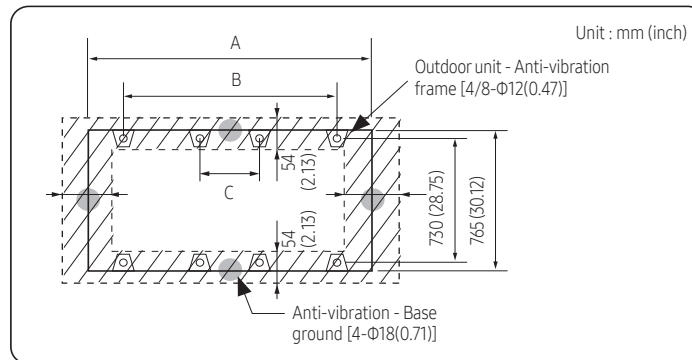

Unit : mm (inch)

Classification	DVM S2 Large type
A	1,295 (51)
B	1,155 (45.5)
C	-

※ Refer to the blueprints in technical data book to make a holes for connecting the anti-vibration pad.

10. Installation

Outdoor unit installation

Examples of draining work

- Construct the drainage ditch with reinforced concretes and make sure that water-proofing work is done.
- For smooth draining of defrost water, make sure to apply 1/50 slope.
- Construct a drainage around the outdoor unit to prevent the defrost water (from the outdoor unit) from stagnating, overflowing or freezing near the installation space.
- When the outdoor unit is installed on the roof, check the strength and waterproof status of the roof.

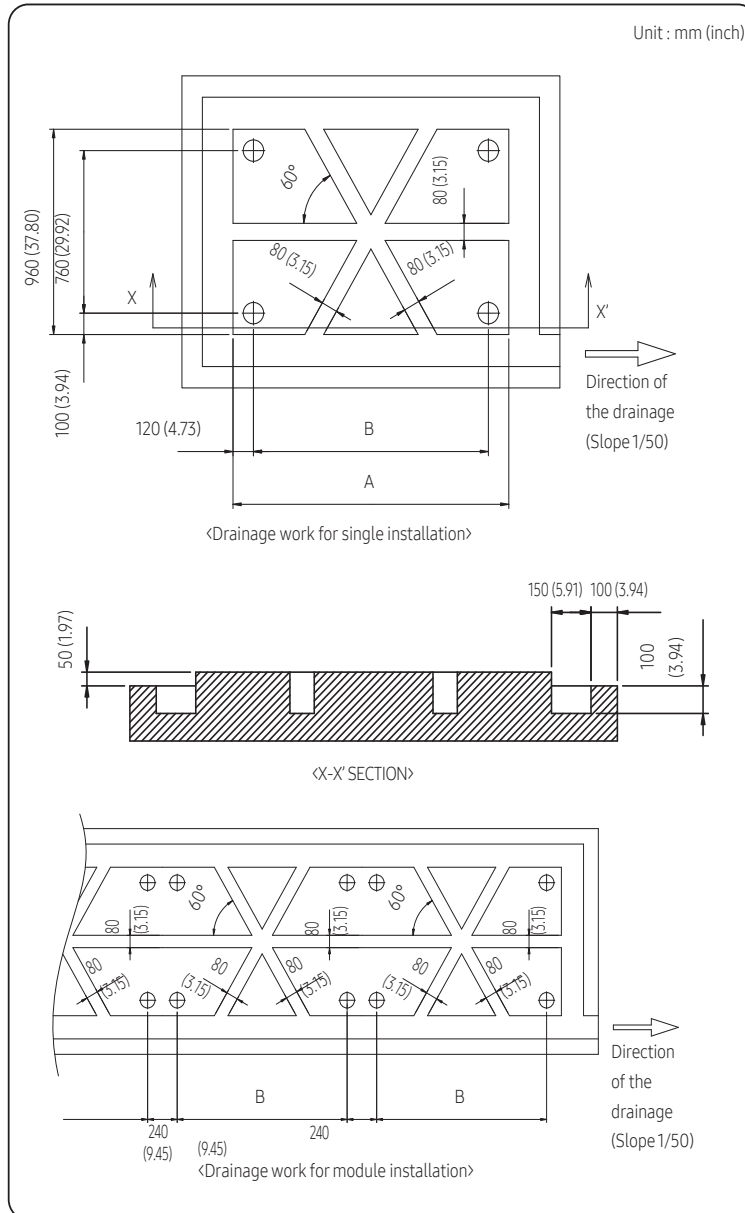

Unit : mm (inch)

Classification	DVM S2 Large type
A	1,395 (54.9)
B	1,155 (45.5)

10. Installation

⚠ CAUTION

- Cautions regarding on connecting the anchor bolt
 - Tighten the rubber washer to prevent the bolt connection part of the outdoor unit from corroding.

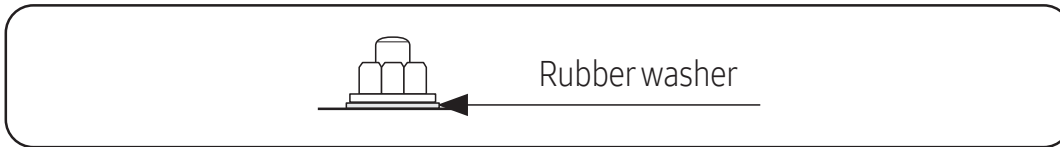

– Anchor specification

Size	Diameter of drill bit (a)	Anchor length (b)	Sleeve length (c)	Insert depth	Fastening torque
Ø 10	14mm (1/2")	75mm (3")	40mm (1-1/2")	50mm (2")	30 N·m

- ※ Use the anchor bolts and nuts that is zinc plated or made of STS material. Regular anchor bolts or nuts may get damaged by corrosion.

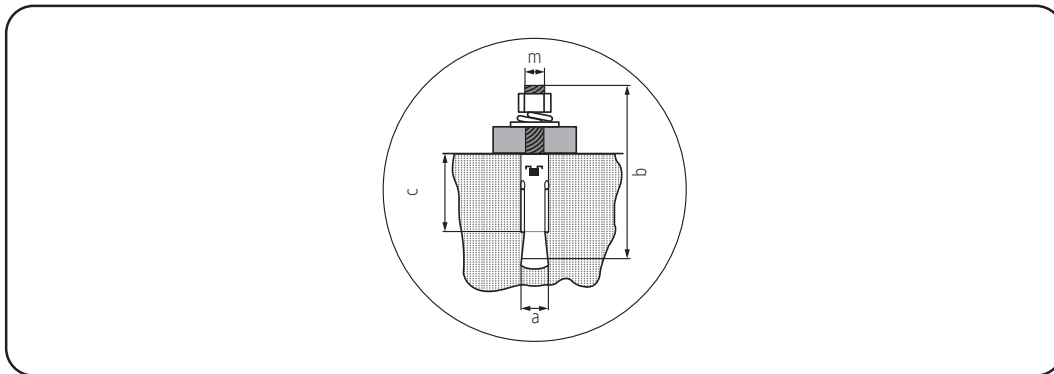

- Cautions regarding on connecting the pipe
 - If you install the outdoor unit on the rooftop, check the strength and make sure to waterproof the rooftop.
 - Construct draining pit around the base construction and pay attention to the drainage around the outdoor unit. (Condensation or defrost water may form during outdoor unit operation.)
 - If there's any possibility of small animals from entering the pipe outlet, block the outlet as shown in the illustration.

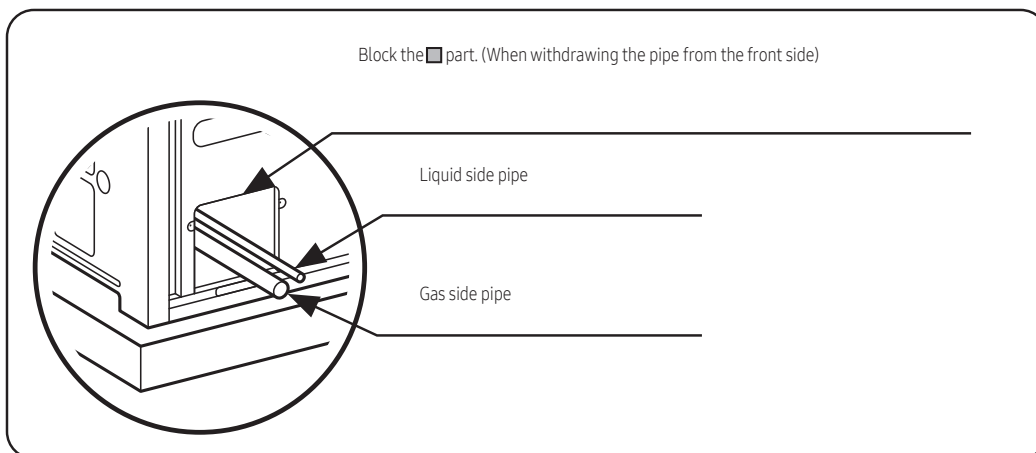

10. Installation

- Cautions regarding on anti-vibration frame installation
 - During installation, make sure there is no gap between the base ground and the supporting structures such as antivibration frame or H beam.
 - Base ground must be constructed strongly to support the bottom part of the anti-vibration mount.

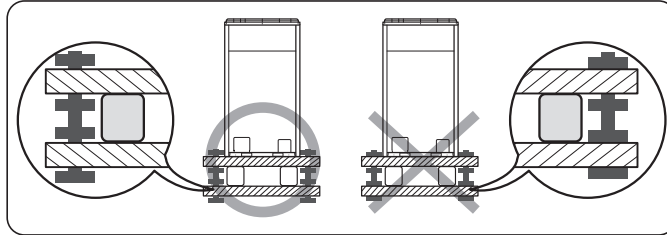

- After installing the anti-vibration frame, untighten the fixing part on the top and bottom part of the frame.
- Caution for installing discharge duct
 - Static pressure of the discharge duct should be within the standard specification when installing the duct.
 - If you remove the fan guard to install the discharge duct, make sure to install a safety net on the duct outlet. Foreign substance may enter into the product and there could be a risk of personal injury.
 - Wear protection equipment at all times when making galvanized sheet metal duct, since the orker may get injured by the sharp parts.
 - When installing the outdoor unit under the tree or near forest, leafs may get into the product and cause problems on the product. Therefore, install a discharge duct to prevent foreign substance infiltration.

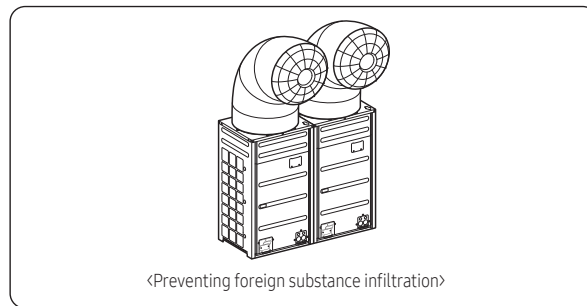

Installing the outdoor unit in various environments

Installing the outdoor unit around the obstacles

- It is necessary to install a discharge guide duct(field supply) to direct exhaust from the fan horizontally, when it is difficult to provide a minimum space of 2m (6.56ft) between the air outlet and a nearby obstacle.

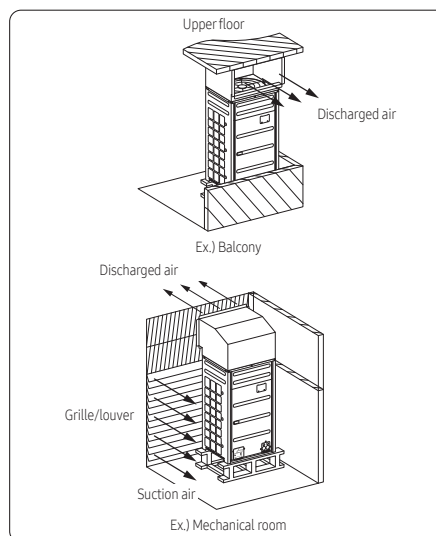

10. Installation

Outdoor unit installation

WARNING

- Should adopt bar type louver. Don't use a type of rain resistance louver.

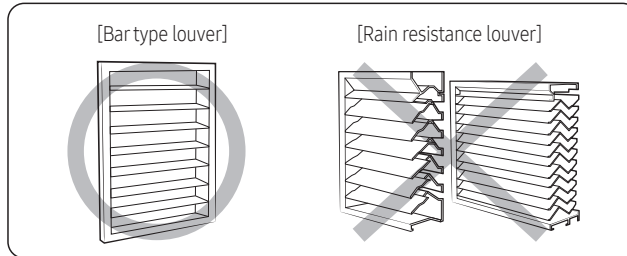

- Louver specifications.
 - Angle criteria : less than 20°
 - Opening ratio criteria : greater than 80%

Installing the outdoor unit in cold region

- In cold regions with lots of snowfall, install a snow prevention duct, as a sufficient countermeasure, to prevent snow from accumulating on the outdoor unit. When the snow prevention duct is not installed, frost may accumulate on the heat exchanger and heating operation may not work normally.
- Air outlet of the duct should not be directed to the enclosed space.

CAUTION

- Cautions regarding on installing the frame and selecting the base ground
 - Height (h) of the frame and the base ground should be higher than the “heaviest expected snowfall”.
 - Area of the frame and the base ground should not be larger than the are of the outdoor unit. Snow may accumulate if the area of the frame or the base ground is larger.

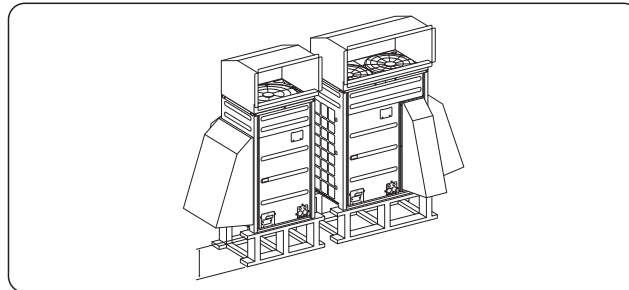

Installing the outdoor unit in windy region

- In windy regions such as near sea shores, protection wall or wind protection duct must be installed for normal operation of the outdoor unit. (Refer to the illustration of the snow prevention duct, for installing the wind protection duct.)
- Install the wind prevention duct with the consideration of major wind direction. If the direction of the discharge part is same as major direction of the wind, it could cause product's performance decrease.

CAUTION

- Cautions regarding on installing the frame and selecting the base ground
 - The base ground must be solid and the outdoor unit must be fixed with anchor bolts.
 - Make sure to install outdoor unit in a place strong enough to withstand its weight. If the place cannot withstand the weight of the outdoor unit, outdoor unit may fall and cause personal injury.
 - When installing on a rooftop subject to strong wind, countermeasures must be taken to prevent the unit from falling down.
 - Use a frame that is resistant to corrosion.

10. Installation

Unit : mm (inch)

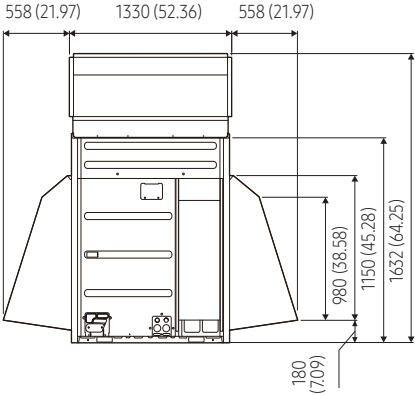
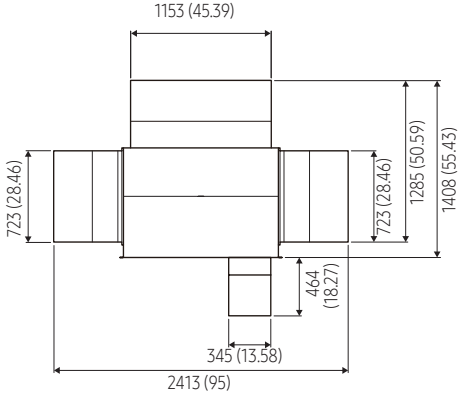

DVM S2 Large type

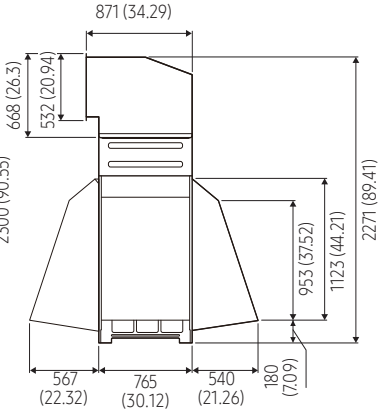

10. Installation

Refrigerant pipe installation

WARNING

- When installing, make sure there is no leakage. When collecting the refrigerant, stop the compressor first before removing the connection pipe. If the refrigerant pipe is not properly connected and the compressor works with the service valve open, the pipe inhales the air and it makes the pressure inside of the refrigerant cycle abnormally high which may lead to explosion and injury.

Refrigerant pipe work

- The length of refrigerant pipe should be as short as possible and the height difference between an indoor and outdoor unit should be minimized.
- Piping work must be done within allowable piping length, height difference, and the allowable length after branching.
- The pressure of the R-410A is high. Use only certified refrigerant pipe and follow the installation method.
- After installing the pipes, calculate the total length of the pipe to check if additional refrigerant is needed. When you need to charge the additional refrigerant, make sure to use R-410A refrigerant.
- Use clean refrigerant pipe and there shouldn't be any harmful ion, oxide, dust, iron content or moisture inside pipe.
- Use tools and accessories that fit on R-410A only.

Tool	Installation process/ purpose	Compatibility with conventional tool
Pipe cutter	Refrigerant pipe installation	Pipe cutting
Flaring tool		Pipe flaring
Refrigerant machine oil		Apply refrigerant oil on flared part
Torque wrench		Connect flare nut with pipe
Pipe bender		Pipe bending
Nitrogen gas	Air tightness test	Prevent oxidation within the pipe
Welder		Pipe welding
Manifold gage	Air tightness test - additional refrigerant charging	Vacuuming, charging refrigerant and checking operation
Refrigerant charging hose		Compatible
Vacuum pump	Pipe drying	Compatible (Use products which contain the check valve to prevent the oil from flowing backward into the outdoor unit.) Use the one that can be vacuumed up to -100.7kpa(5Torr).
Scale for refrigerant charging	Refrigerant charging	Compatible
Gas leak detector	Gas leak test	Need exclusive one (Ones used for R-134a is compatible)
Flare nut	Must use the flare nut equipped with the product.	

10. Installation

Selecting refrigerant pipe

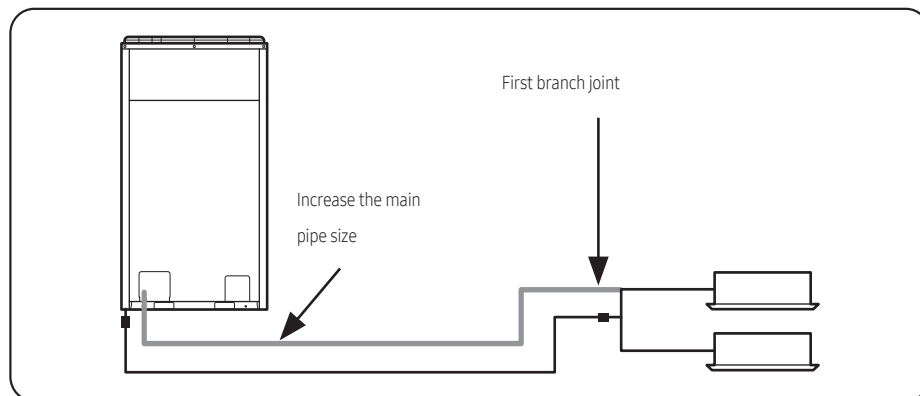

- Install the refrigerant pipe according to main pipe size of each outdoor unit capacity.
- When the pipe length (including elbow) between an outdoor unit and the farthest indoor unit exceeds 90m (295ft), you must increase the size of the pipe (main pipe) by one grade which connects between the outdoor unit to the first branch joint.

10. Installation

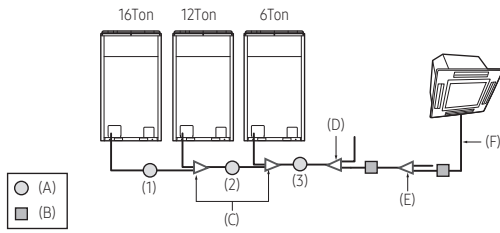

Ex.) 34 Ton

Ton	No.	Pipe size (O.D)			
		Liquid pipe		Gas pipe	
		mm	inch	mm	inch
16	(1)	15.88	5/8	28.58	11/8
28	(2)	19.05	3/4	34.92	13/8
34	(3)	19.05	3/4	41.28	15/8

Size of the pipe connected to the outdoor unit (A)

Select the size of the main pipe according to the below table.

Outdoor unit capacity (MBH) (Cooling)	Outdoor unit capacity (kW) (Cooling)	*Maximum pipe length within 295ft (90m)				*Maximum pipe length over 295ft (90m)					
		Liquid		Gas		Liquid		Gas			
		inch	mm	inch	mm	inch	mm	inch	mm		
Capacity ≤ 85	Capacity ≤ 25	Ø3/8	Ø9.52	Ø3/4	Ø19.05	Ø1/2	Ø12.70	Ø7/8	Ø25.40		
85 < Capacity ≤ 99	25 < Capacity ≤ 29									Ø22.22	note1)
99 < Capacity ≤ 120	29 < Capacity ≤ 35	Ø1/2	Ø12.70	Ø1 1/8	Ø28.58	Ø5/8	Ø15.88	Ø1 1/8	Ø28.58		
120 < Capacity ≤ 140	35 < Capacity ≤ 41									Ø31.75	note2)
140 < Capacity ≤ 160	41 < Capacity ≤ 47									Ø31.75	note2)
160 < Capacity ≤ 181	47 < Capacity ≤ 53									Ø31.75	note2)
181 < Capacity ≤ 222	53 < Capacity ≤ 65	Ø5/8	Ø15.88	Ø1 1/8	Ø34.92	Ø3/4	Ø19.05	Ø1 3/8	Ø34.92		
222 < Capacity ≤ 240	65 < Capacity ≤ 70									Ø38.10	note3)
240 < Capacity ≤ 336	70 < Capacity ≤ 98	Ø3/4	Ø19.05	Ø1 5/8	Ø41.28	Ø7/8	Ø22.22	Ø1 5/8	Ø41.28		
336 < Capacity ≤ 467	98 < Capacity ≤ 137									note3)	note3)
467 < Capacity ≤ 583	137 < Capacity ≤ 171									note3)	note3)

*Maximum pipe length : The pipe length between an outdoor unit and the farthest indoor unit.

Note1) If Ø1" (25.40mm) pipe is not available on site, use Ø1 1/8" (28.58mm) pipe.

Note2) If Ø1 1/4" (31.75mm) pipe is not available on site, use Ø1 3/8" (34.92mm) pipe.

Note3) If Ø1 1/2" (38.10mm) pipe is not available on site, use Ø1 5/8" (41.28mm) pipe.

† For the case that the diameter of the default pipe of an outdoor unit does not match that of the pipe installed on the site, a socket is provided by default together with the outdoor unit.

Size of the pipe between branch joints (B)

Select the pipe size according to the sum of indoor unit capacity which will be connected after the branch.

† However, if the size of the pipe between branch joints (B) is bigger than the size of the pipe connected to the outdoor unit (A), apply the pipe size (A).

Indoor unit capacity (MBH)	Indoor unit capacity (kW)	Branch pipe length within 148ft (45m)				Branch pipe length between 148ft-295ft (45-90m)							
		Liquid		Gas		Liquid		Gas					
		inch	mm	inch	mm	inch	mm	inch	mm				
Capacity < 19	Capacity < 5.7	Ø1/4	Ø6.35	Ø1/2	Ø12.70	Ø3/8	Ø9.52	Ø5/8	Ø15.88				
19 ≤ Capacity < 55	5.7 ≤ Capacity < 16									Ø5/8	Ø15.88	Ø3/4	Ø19.05
55 ≤ Capacity < 79	16 ≤ Capacity < 23.2	Ø3/8	Ø9.52	Ø3/4	Ø19.05	Ø1/2	Ø12.70	Ø7/8	Ø22.22				
79 ≤ Capacity < 115	23.2 ≤ Capacity < 33.6									Ø7/8	Ø22.22	Ø1 note1)	note1)
115 ≤ Capacity < 133	33.6 ≤ Capacity < 39									note1)	note1)		
133 ≤ Capacity < 150	39 ≤ Capacity < 44	Ø1/2	Ø12.70	Ø1 1/8	Ø28.58	Ø5/8	Ø15.88	Ø1 1/8	Ø28.58				
150 ≤ Capacity < 172	44 ≤ Capacity < 50.4									Ø31.75	note2)		
172 ≤ Capacity < 229	50.4 ≤ Capacity < 67.2									Ø31.75	note2)		
230 ≤ Capacity < 248	67.2 ≤ Capacity < 72.8									Ø31.75	note2)		
248 ≤ Capacity < 344	72.8 ≤ Capacity < 100.8	Ø3/4	Ø19.05	Ø1 3/8	Ø34.92	Ø7/8	Ø22.22	Ø1 1/2	Ø38.10				
344 ≤ Capacity < 392	100.8 ≤ Capacity < 115									note3)	note3)		
392 ≤ Capacity < 592	115 ≤ Capacity < 173.6	Ø7/8	Ø22.22	Ø1 5/8	Ø41.28	Ø7/8	Ø22.22	Ø1 5/8	Ø41.28				
592 ≤ Capacity < 676	173.6 ≤ Capacity < 198									note4)	note4)		
676 ≤ Capacity < 860	198 ≤ Capacity < 252									note4)	note4)		
860 ≤ Capacity	252 ≤ Capacity	Ø1 note1)	note1)	Ø2 1/8	Ø53.98	Ø1 1/8	Ø28.58	Ø2 1/8	Ø53.98				

Note1) If Ø1" (25.40mm) pipe is not available on site, use Ø1 1/8" (28.58mm) pipe.

Note2) If Ø1 1/4" (31.75mm) pipe is not available on site, use Ø1 3/8" (34.92mm) pipe.

Note3) If Ø1 1/2" (38.10mm) pipe is not available on site, use Ø1 5/8" (41.28mm) pipe.

Note4) If Ø1 3/4" (44.45mm) pipe is not available on site, use Ø2 1/8" (53.98mm) pipe.

Branch joint (C-E)

Branch joint between outdoor units (C)

Select a branch joint according to the sum of the capacity of outdoor units connected to the branch joint.

Classification	Outdoor unit capacity		Model name
	MBH	kW	
Y-joint for outdoor unit (C)	Capacity ≠ 578	Capacity ≠ 248	MXJ-TA3819M
	467 < Capacity	137 < Capacity	MXJ-TA4422M

First branch joint (D)

Select according to the sum of the capacity of the outdoor unit.

Classification	Outdoor unit capacity		Model name
	MBH	kW	
Y-joint (D)	Capacity ≠ 251	Capacity ≠ 52	MXJ-YA2512M
	Capacity ≠ 271	Capacity ≠ 58	MXJ-YA2812M
	Capacity ≠ 349	Capacity ≠ 81	MXJ-YA2815M
	Capacity ≠ 447	Capacity ≠ 99	MXJ-YA3419M
	Capacity ≠ 578	Capacity ≠ 248	MXJ-YA4119M
	467 < Capacity	137 < Capacity	MXJ-YA4422M

Branch joint (E)

Select a branch joint according to the sum of indoor unit capacity which will be connected after the branch.

※ However, if the branch joints (E) is bigger than the first branch joint (D), apply the branch joint of the same size as the first branch joint (D).

Classification	Indoor unit capacity		Model name
	MBH	kW	
Y-joint (E)	Capacity < 55	Capacity < 16	MXJ-YA1509M
	55 ≤ Capacity < 133	16 ≤ Capacity < 39	MXJ-YA2512M
	133 ≤ Capacity < 172	39 ≤ Capacity < 50.4	MXJ-YA2812M
	172 ≤ Capacity < 248	50.4 ≤ Capacity < 72.8	MXJ-YA2815M
	248 ≤ Capacity < 344	72.8 ≤ Capacity < 100.8	MXJ-YA3419M
	344 ≤ Capacity < 478	100.8 ≤ Capacity < 140	MXJ-YA4119M
Distribution header (E)	478 < Capacity	140 < Capacity	MXJ-YA4422M
	Capacity < 172 (for 4 rooms)	Capacity < 50.4 (for 4 rooms)	MXJ-HA2512M
	Capacity < 248 (for 8 rooms)	Capacity < 72.8 (for 8 rooms)	MXJ-HA3115M
	Capacity < 478 (for 8 rooms)	Capacity < 140 (for 8 rooms)	MXJ-HA3819M

Size of the pipe between the branch joint and the indoor unit (F)

Select according to the capacity of the indoor unit.

Indoor unit capacity		Liquid		Gas	
MBH	kW	inch	mm	inch	mm
Capacity ≤ 20	Capacity ≤ 6	Ø1/4	Ø6.35	Ø1/2	Ø12.7
20 < Capacity ≤ 54	6 < Capacity ≤ 16	Ø3/8	Ø9.52	Ø5/8	Ø15.88
54 < Capacity ≤ 78	16 < Capacity ≤ 23	Ø3/8	Ø9.52	Ø3/4	Ø19.05
78 < Capacity	23 < Capacity	Ø3/8	Ø9.52	Ø7/8	Ø22.22

† If the criteria for selecting the branch in the outdoor installation manual and the branch installation manual are different, please select the branch in accordance with the outdoor installation manual.

10. Installation

Refrigerant pipe installation

When all the following conditions are met, install the main liquid pipe that is one step smaller to reduce piping load and the amount of refrigerant.

Note that the refrigerant for the main liquid pipe must be added by the specified amount upon reduction.

Condition 1: The vertical piping length is less than 131 ft (40m)

Condition 2: For BG units, allowable length A (ft) \geq max. piping length (ft) / { 1 - (vertical piping length (ft) * 0.0046) }

※ Max. piping length : The equivalent length (ft) of piping from the outdoor unit to the farthest indoor unit

For SI units, allowable length A (m) \geq max. piping length (m) / { 1 - (vertical piping length (m) * 0.015) }

※ Max. piping length : The equivalent length (m) of piping from the outdoor unit to the farthest indoor unit

※ If the conditions above are satisfied and one-size smaller piping has been installed, set the "liquid pipe (main pipe) size reduction" option.

- Length allowed to reduce the diameter of liquid pipe, A (equivalent length)

Outdoor unit capacity (Ton)	Maximum pipe length within 90m (295.3ft)				Maximum pipe length over 90m (295.3ft)			
	Pipe diameter		Allowable length		Pipe diameter		Allowable length	
	mm	inch	m	ft	mm	inch	m	ft
6	This capacity is not supported.							
8	This capacity is not supported.							
10	9.52	3/8	50	164	12.7	1/2	200	656
12	9.52	3/8	30	98	12.7	1/2	160	525
14	12.7	1/2	90	295	15.88	5/8	200	656
16	12.7	1/2	90	295	15.88	5/8	200	656
18	12.7	1/2	80	262	15.88	5/8	200	656
20	12.7	1/2	60	197	15.88	5/8	190	623
22	15.88	5/8	90	295	19.05	3/4	200	656
24	15.88	5/8	90	295	19.05	3/4	200	656
26	15.88	5/8	90	295	19.05	3/4	200	656
28	15.88	5/8	90	295	19.05	3/4	200	656
30	15.88	5/8	90	295	19.05	3/4	200	656
32	15.88	5/8	80	262	19.05	3/4	200	656
34	15.88	5/8	70	230	19.05	3/4	200	656
36	15.88	5/8	60	197	19.05	3/4	190	623
38	15.88	5/8	60	197	19.05	3/4	170	558
40	15.88	5/8	50	164	19.05	3/4	150	492

E.g.1 : For a site with 18 tons (BG units), max. piping length of 460ft (395 ft-long horizontal piping and 65ft-long vertical piping) condition, allowable length A \geq max. piping length / { 1 - (vertical piping length * 0.0046) }
 $656ft \geq 460ft / \{ 1 - (65 * 0.0046) \} = 460ft / 0.701 = 656ft$

E.g.2 : For a site with 18 tons (SI units), max. piping length of 140m (120 m-long horizontal piping and 20m-long vertical piping) condition, allowable length A \geq max. piping length / { 1 - (vertical piping length * 0.015) }
 $200m \geq 140m / \{ 1 - (20 * 0.015) \} = 140m / 0.7 = 200m$

Accordingly, the max. piping length of 140m (120m-long horizontal piping and 20m-long vertical piping) is allowable.

10. Installation

Additional refrigerant

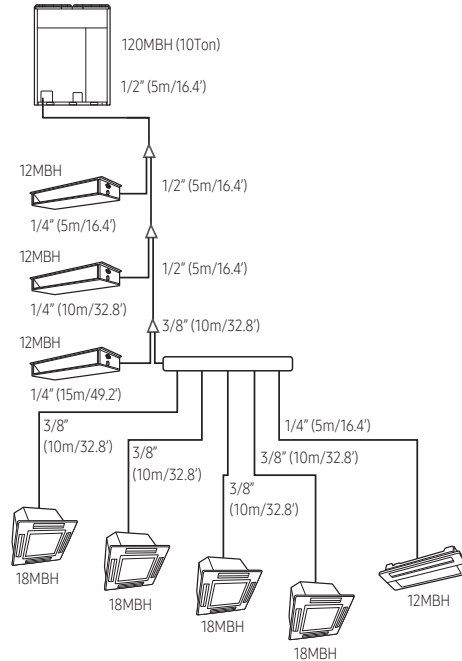

Refrigerant pipe installation

- Basic amount of refrigerant within the outdoor unit [lb(kg)]
 - Amount of additional refrigerant has to be calculated based on the sum of all liquid pipe length.

Classification	AM072BXVT**	AM096BXVT**	AM120BXVT**
Basic amount [lb(kg)]	17.6 (8.0)	23.1 (10.5)	23.1 (10.5)

- Amount of additional refrigerant depending on the pipe size (@)
 - Amount of additional refrigerant has to be calculated based on the sum of all liquid pipe length.

Size of liquid pipe [mm (inch)]	Φ1/4 (Φ6.35)	Φ3/8 (Φ9.52)	Φ1/2 (Φ12.7)	Φ5/8 (Φ15.88)	Φ3/4 (Φ19.05)	Φ7/8 (Φ22.22)	Φ1 (Φ25.4)	Φ1 1/8 (Φ28.58)
Additional amount [lb/ft (kg/m)]	0.013 (0.02)	0.04 (0.06)	0.084 (0.125)	0.121 (0.18)	0.181 (0.27)	0.235 (0.35)	0.356 (0.53)	0.437 (0.65)
Amount of refrigerant added when the diameter of liquid pipe is reduced [kg/m (lb/ft)]	-	0.054 (0.08)	0.087 (0.13)	0.131 (0.195)	0.188 (0.28)	0.282 (0.42)	0.356 (0.53)	-

- For the indoor unit already connected to EEV kit, the additional refrigerant charging is 0.0067lb/ft (0.01kg/m) regardless of the pipe size.

10. Installation

- Amount of additional refrigerant for each indoor unit (㉞)

Unit : lb(kg)

Capacity Index (MBH)	5	6	7	9	12	15	18	20	24	27	28	30	32	36	42	48	54	60	72	76	96	
1way cassette (AM***N1DCH/**)			0.55 (0.25)	0.55 (0.25)	0.55 (0.25)																	
1way cassette (AM***N1PCH/**)	0.33 (0.15)		0.33 (0.15)	0.55 (0.25)	0.55 (0.25)	0.71 (0.32)	0.71 (0.32)		0.71 (0.32)													
4way cassette S (600x600) (AM***NNDCH/**)	0.64 (0.29)		0.64 (0.29)	0.64 (0.29)	0.64 (0.29)		0.82 (0.37)	0.82 (0.37)														
4way cassette S (AM***RN4DCH/**)		0.99 (0.45)		0.99 (0.45)	0.99 (0.45)		1.26 (0.57)		1.26 (0.57)			2.20 (1.00)		2.20 (1.00)		2.20 (1.00)						
4way cassette S (AM***BN4PCH/**)		1.61 (0.73)		1.61 (0.73)	1.61 (0.73)		1.61 (0.73)		1.61 (0.73)			1.94 (0.88)		1.94 (0.88)		1.94 (0.88)						
360 cassette (AM***KN4DCH/**)				0.99 (0.45)	0.99 (0.45)		0.99 (0.45)		0.99 (0.45)			1.52 (0.69)		1.52 (0.69)		1.52 (0.69)						
LSP duct (AM***FNL DCH/**)			0.77 (0.35)	0.77 (0.35)	0.77 (0.35)		0.99 (0.45)		0.99 (0.45)			0.93 (0.42)		0.93 (0.42)		1.37 (0.62)						
MSP duct (AM***ANMDCH/**)		0.99 (0.45)	0.99 (0.45)	0.99 (0.45)	0.99 (0.45)	0.99 (0.45)	1.50 (0.68)															
HSP duct (AM***ANHDCH/**)									1.50 (0.68)	1.50 (0.68)		1.50 (0.68)		1.85 (0.84)		1.85 (0.84)						
HSP duct (AM***FNHDCH/**) (AM***JNHDCH/**)																	2.01 (0.91)			2.60 (1.18)	2.60 (1.18)	
OAP duct (AM***NE*CH/**)																			2.60 (1.18)		2.60 (1.18)	
Floor Standing (AM***NFDCH/**) (AM***NGDCH/**)		0.26 (0.12)		0.49 (0.22)	0.49 (0.22)		0.71 (0.32)		0.71 (0.32)													
Ceiling (AM***NCDCH/**)							0.86 (0.39)		0.86 (0.39)					1.23 (0.56)		2.09 (0.95)						
MPAHU(V-AHU) (AM***NZDCH/**)				0.73 (0.33)		1.10 (0.50)		1.10 (0.50)				1.83 (0.83)		1.94 (0.88)		2.60 (1.18)	2.80 (1.27)	3.73 (1.69)	3.73 (1.69)			
Wall mounted (with EEV) (AM***NVDCH/**) (AM***NQDCH/**)	0.51 (0.23)		0.51 (0.23)	0.71 (0.32)	0.71 (0.32)	1.06 (0.48)	1.06 (0.48)		1.06 (0.48)		1.41 (0.64)		1.50 (0.68)									
MCU (MCU-S*NE**N)	1.10 (0.50)																					

- ※ If there is no additional refrigerant value for the indoor unit in the above table, refer to the indoor unit installation manual.
- If AHU kit is included among the indoor units, you must add 0.018kg(0.04lb) of refrigerant for every 1MBH of AHU capacity increase.
Note1) In case the capacity conjunction of the Hydro Unit HT exceeds 50% among the total indoor unit, please don't put the additional refrigerant.
- Method to calculate total amount of additional refrigerant
 - Amount of additional refrigerant depending on th pipe length (㉞)
 - Amount of additional refrigerant for each indoor unit (㉞) = Σ (Amount of additional refrigerant for each connected indoor unit)
※ Refer to the table
 - Total amount of additional refrigerant = ㉞ + ㉞
- ※ Sum of total amount of additional refrigerant and the basic amount of refrigerant should not exceed 100kg (220lb). If the refrigerant exceeds 100kg (220lb), separate the module so that weight of the refrigerant doesn't exceed 100kg (220lb).
Ex> If the outdoor unit's basic refrigerant amount is 8.7kg (19.1lb), the total amount of additional refrigerant(㉞+㉞) should not exceed 91.3kg (220.9lb)

10. Installation

- Example of refrigerant calculation for HP models

Classification	Size of liquid pipe [mm (inch)]	Length [m (ft)]	Unit amount of refrigerant [kg/m (lb/ft)]	Amount of additional refrigerant [kg (lb)]	Total amount of additional refrigerant [kg (lb)]
		①	②	①×②	Σ(①×②)
Liquid pipe (㉑)	Ø6.35 (Ø1/4)	35 (114.8)	0.02 (0.013)	0.7 (1.49)	㉑ 5.575 (12.19)
	Ø9.52 (Ø3/8)	50 (164.0)	0.06 (0.040)	3.0 (6.56)	
	Ø12.70 (Ø1/2)	15 (49.2)	0.125 (0.084)	1.875 (4.13)	

Classification	Model name of indoor unit	Number of indoor units	Unit amount of refrigerant [kg/EA (lb/EA)]	Amount of additional refrigerant [kg (lb)]	Total amount of additional refrigerant [kg (lb)]
		①	②	①×②	Σ(①×②)
Indoor unit (㉒)	4way cassette (AM018RN4DCH)	4	0.57 (1.26)	2.28 (4.92)	㉒ 3.78 (8.22)
	LSP duct (AM024FNLDCH)	2	0.45 (0.99)	0.90 (1.98)	
	LSP duct (AM012FNLDCH)	1	0.35 (0.77)	0.35 (0.77)	
	1way cassette (AM012AN1PCH)	1	0.25 (0.55)	0.25 (0.55)	

– Total amount of refrigerant (㉑ + ㉒) = 5.575 + 3.78 = 9.355(kg)
 = 12.19 + 8.22 = 20.41(lb)

10. Installation

Refrigerant pipe installation

Pipe installation for an outdoor unit

- 1 Direction of the pipe Refrigerant pipe can be withdrawn from the front, left and right side. Take necessary method to install the pipes according to the condition of the installation site.

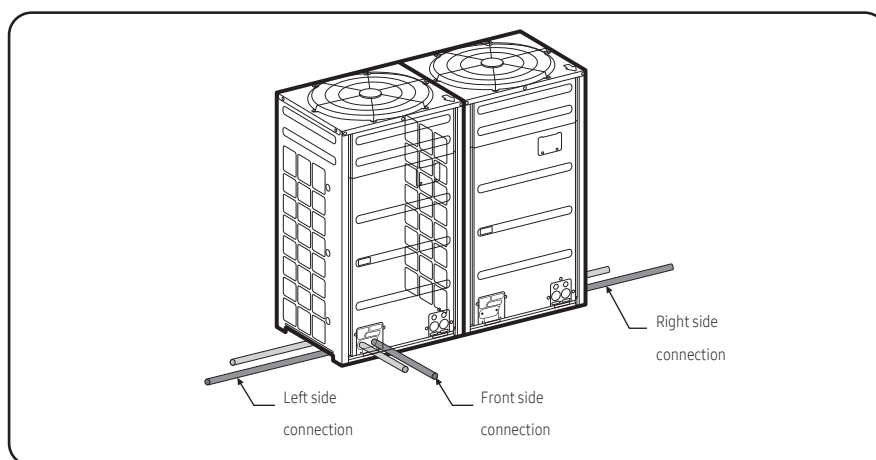

⚠ CAUTION

- Caution for using knock-out hole

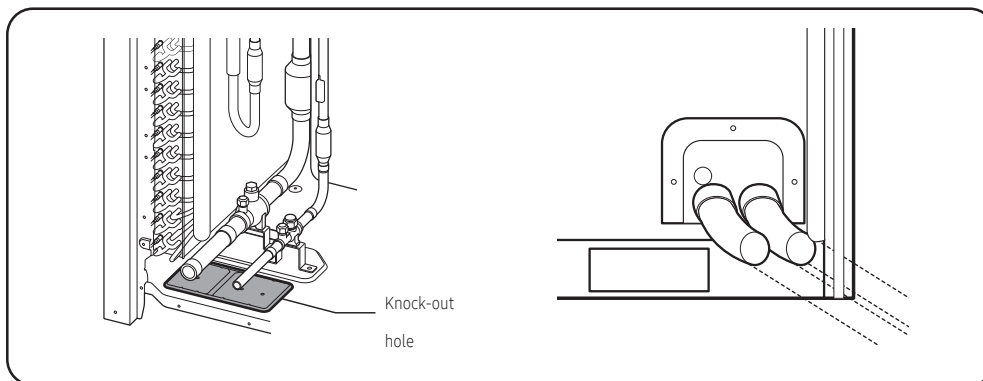

- Make sure to prevent any damages on the exterior of the outdoor unit.
- Remove all burrs around the knock-out hole and apply varnish on the cross section and edges of the knock-out hole to prevent rust.
- Use a cable protection tube and bushing to prevent a cable from being damaged when passing through a knock-out hole.

10. Installation

Refrigerant pipe installation

Pipe installation for an outdoor unit

2 Connecting refrigerant pipe for outdoor unit

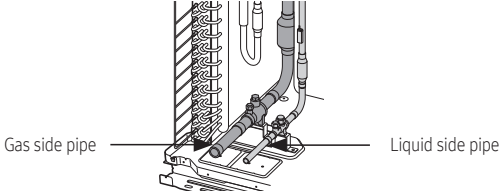
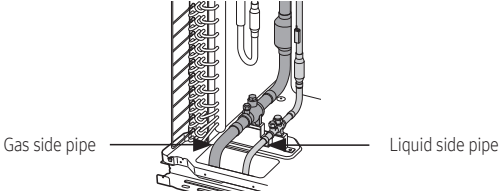
Classification	Front side connection	Right/left (and bottom) side connection
Working process	<ul style="list-style-type: none"> First, remove the piping cover from the outdoor unit. Separate the knock-out hole that you are going to use. If you separate the knock-out hole that is going to be unused, small animals such as squirrels and rats may get into the unit through the hole. Fix the bottom side of the piping cover first and then fix the top part of it. 	<ul style="list-style-type: none"> Separate the knock-out hole at the bottom side of the unit and install the pipe. After installing and insulating the pipe, close up the remaining holes. If not, small animals such as rats and squirrels may get inside the unit.
H/P		

CAUTION

- Caution for welding the pipe to an outdoor unit
 - When welding the pipe, the unit may get damaged by the heat and flame from welding. Use a flame proofing cloth to protect the unit from a welding fire or flame. Sensor for detecting outside temperature is located on the left side of the welding part so be extra careful not to damage the sensor when welding.
 - The O-ring and Teflon packing inside service valve may get damaged by the heat from welding. Wrap the bottom side of the service valve with a wet cloth and weld it as shown in the illustration. Also, water dripping from the wet cloth may interrupt the welding. Make sure the water does not drip from the wet cloth.
 - Make sure that connected pipes does not interrupt each other or make contact with the product. (Vibration may cause damage to the pipes.)
 - When removing the sealed pipe on the bottom side of the service valve, cut it with a pipe cutter first and then start the welding.
When the sealed pipe is welded without cutting, you may get injured by the refrigerant within the pipe.

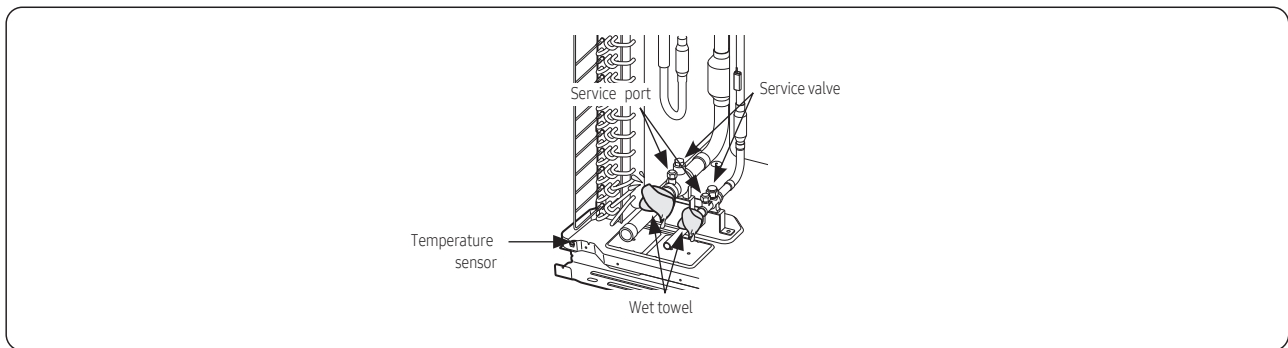

10. Installation

3 Pipe installation between the outdoor units

- You will need branch joints, which is an optional accessory, for connecting in between outdoor units in order to combine outdoor units in module.
 - ※ For optimal distribution of the refrigerant, you must use Y-joint as branch joint for connecting outdoor units. (Do not use T-joint)
- When you install the outdoor units in module, there is no restriction of installation order among outdoor units.
- Height of the connection pipe should be same or lower than the ones connected to the outdoor units.
- Check the changes in comparison with the DVM II, III and IV.

Caution	Correct installation	Incorrect installation
Refrigerant pipes should be connected at the same or lower level than the ones connected to the outdoor unit.		
Refrigerant pipes must be connected by the side of the product.	<p>Straight section should be 300mm (12inch) or more</p>	
Branch joint between outdoor units must be installed horizontally.		
Install a vertical trap in following cases as shown in the figure: Case1. Pipe length between outdoor unit branches exceeds 2m(6.56ft). Case2. Pipe length between outdoor unit and its branch exceeds 2m(6.56ft).	<p>311'9"-9'000 300mm (12inch)</p> <p>1m (3.28ft) or less Over 2m (6.56ft)</p>	<p>Over 2m (6.56ft)</p> <p>Over 2m (6.56ft)</p>

10. Installation

Refrigerant pipe installation

Examples of refrigerant pipe installation

1 Using Y-joint

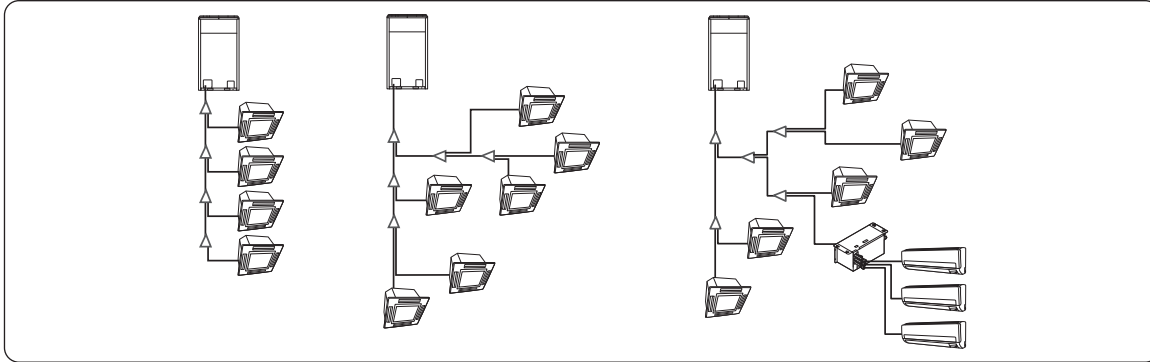

2 Using distribution header

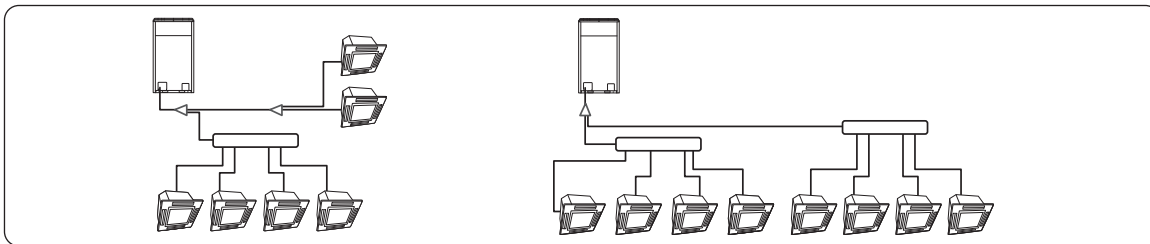

10. Installation

Refrigerant pipe installation

Allowable length of the refrigerant pipe and the installation examples

Classification	Single Installation	Module installation
Installing only with Y-joint		
Installing with Y-joint and distribution header		
Installing only with distribution header		

Classification		Example		Remarks	
Maximum allowable length of pipe	Outdoor unit ~ Indoor unit	Actual length (Equivalent length)	200 m (656') and below [220 m (722') and below]	Installing only with Y-joint $a+b+c+d+e+f+g+p \leq 200$ m (220 m)/656'(722')	Equivalent length Y-joint: 0.5 m (1.64'), Distribution header: 1 m (3.28')
				Installing with Y-joint and distribution header $a+b+h \leq 200$ m (220 m), $a+i+k \leq 200$ m (220 m)/656'(722')	
				Installing only with distribution header $a+i \leq 200$ m (220 m)/656'(722')	
	Outdoor unit ~ Outdoor unit (Module installation)	Total length of pipe (m)	1000 m (3281') or less	Installing only with Y-joint $a+b+c+d+e+f+g+h+i+j+k+l+m+n+p \leq 1000$ m (3281')	-
				Installing with Y-joint and distribution header $a+b+c+d+e+f+g+h+i+j+k \leq 1000$ m (3281')	-
				Installing only with distribution header $a+b+c+d+e+f+g+h+i \leq 1000$ m (3281')	-
	Pipe length	10 m (33') or less	$x \leq 10$ m (33'), $y \leq 10$ m (33'), $z \leq 10$ m (33')		
	Equivalent length	13 m (43') or less	$x \leq 13$ m (43'), $y \leq 13$ m (43'), $z \leq 13$ m (43')		
Maximum allowable height difference of pipe	Outdoor unit ~ Indoor unit	110/110 m (361'/361') <small>Note 2)</small>	$H1 \leq 110/110$ m (361'/361')		
	Indoor unit ~ Indoor unit	50 m (164') or less	$H2 \leq 50$ m (164')	But, when wall-mount type indoor units with EEV (AM***NQD* / AM***NVD*) is installed, H2 is 15 m (49') or less.	

10. Installation

Classification				Example		Remarks
Maximum allowable length after branch joint	First branch joint ~ Farthest Indoor unit	Pipe length	45m (148') or less	Installing only with Y-joint	$b+c+d+e+f+g+p \leq 45m (148')$	-
				Installing with Y-joint and distribution header	$i+k \leq 45m (148')$	
			Installing only with distribution header	$i \leq 45m (148')$		
		45m~90m (148'~295') <small>Note 1)</small>	Required conditions must be satisfied		-	

EEV kit			Model name		Remarks
EEV kit ~ Indoor unit	Actual pipe length	2m (6.6')	MEV-E24SA	1 indoor	Apply to products without EEV (Wall mount & ceiling)
			MEV-E32SA		
		20m (66') or less	MXD-E24K132A	2 indoor	
			MXD-E24K200A		
			MXD-E32K200A		
			MXD-E24K232A	3 indoor	
			MXD-E24K300A		
			MXD-E32K224A		
MXD-E32K300A					

※ Please refer to the EEV Kit manual.

Note 1) Required condition

Classification	Condition	Example
First branch joint ~ Farthest Indoor unit	$45m (148') \leq b+c+d+e+f+g+p \leq 90m (295')$: branch pipes (b, c, d, e, f, g) size must be increased by 1 grade	
Total length of extended pipe	If the size of pipe (main pipe), between the first branch joint and the outdoor unit, is not increased by 1 grade, $a+(b+c+d+e+f+g) \times 2 + h+i+j+k+l+m+n+p \leq 1000m (3281')$	
	If the size of pipe (main pipe), between the first branch joint and the outdoor unit, is increased by 1 grade, $(a+b+c+d+e+f+g) \times 2 + h+i+j+k+l+m+n+p \leq 1000m (3281')$	
Each Y-joint ~ Each indoor unit	$h, i, j, \dots, p \leq 45m (148')$	
Difference between the distance of the outdoor unit to the farthest indoor unit and nearest indoor unit	$(a+b+c+d+e+f+g+p)-(a+h) \leq 45m (148')$	

Note 2) When indoor unit is located at higher level than outdoor unit, allowable height difference is 110m(361'), (If the height difference is over 40m(131'), contact your local dealer for more information.)

but when the indoor unit is located at lower level than outdoor unit, allowable height difference is 110m(361') (If the height difference is over 50m(164'), need to decide whether to install PDM kit or not.)

Model name of the PDM kit : MXD-A38K2A, MXD-A12K2A, MXD-A58K2A

10. Installation

How to connect the pipes

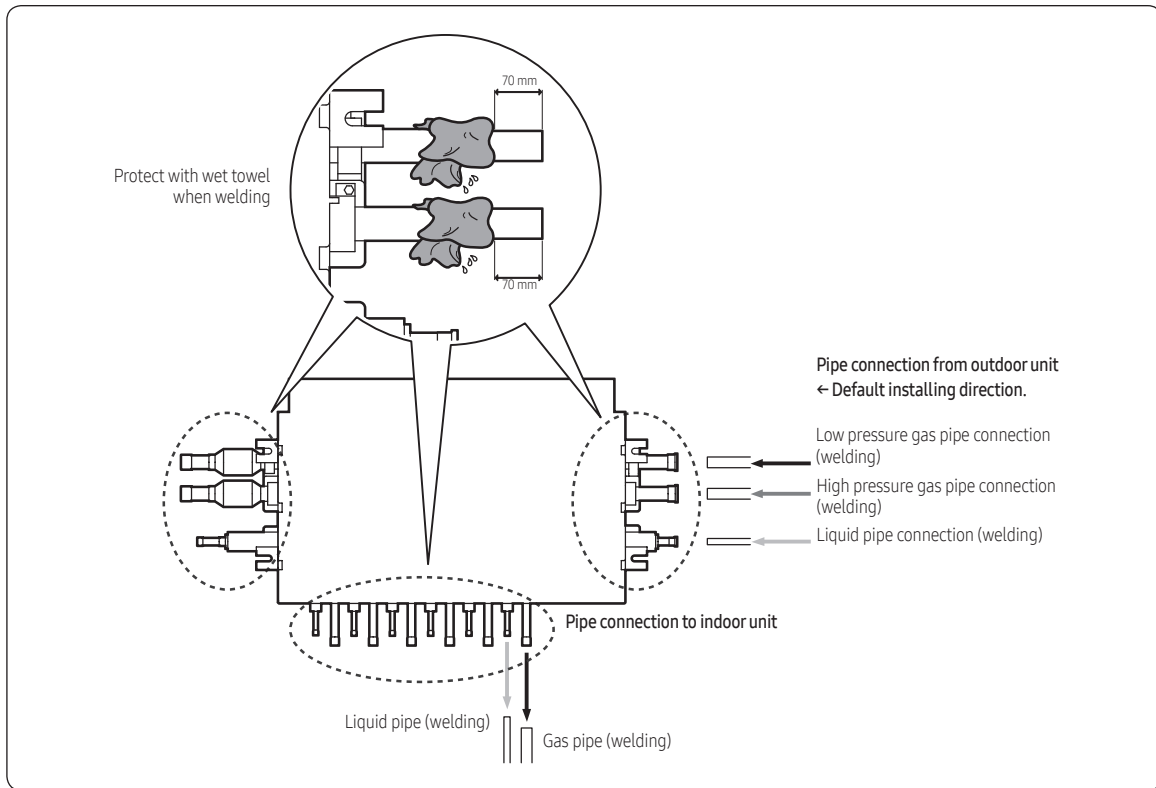

- ※ When installing MCU, use the pattern sheet for installation that is provided with the product.
- ※ When welding the gas pipes, protect the product with the flame-proof sheet.
- ※ When connecting the MCU with outdoor units, default direction is set in the MCU.
If installing opposite direction, weld the enclosed copper cap in each high pressure, low pressure and liquid pipes.

10. Installation

Electrical wiring work

Electric Characteristics

1. Heat Pump / Heat Recovery (208~230V)

Nom. Ton	Model	Units		Module #1						Module #2						Module #3					
				RLA		FLA		Power Supply		RLA		FLA		Power Supply		RLA		FLA		Power Supply	
		Hz	Volts	Comp1	Comp2	FAN1	FAN2	MCA	MOP	Comp1	Comp2	FAN1	FAN2	MCA	MOP	Comp1	Comp2	FAN1	FAN2	MCA	MOP
6Ton	AM072BXVTF*	60	208-230	18	18	4.2	4.2	50	60	-	-	-	-	-	-	-	-	-	-	-	-
8Ton	AM096BXVTF*	60	208-230	22	22	4.2	4.2	62	70	-	-	-	-	-	-	-	-	-	-	-	-
10Ton	AM120BXVTF*	60	208-230	28	28	4.2	4.2	76	90	-	-	-	-	-	-	-	-	-	-	-	-
12Ton	AM144BXVTF*	60	208-230	18	18	4.2	4.2	50	60	18	18	4.2	4.2	50	60	-	-	-	-	-	-
14Ton	AM168BXVTF*	60	208-230	18	18	4.2	4.2	50	60	22	22	4.2	4.2	62	70	-	-	-	-	-	-
16Ton	AM192BXVTF*	60	208-230	18	18	4.2	4.2	50	60	28	28	4.2	4.2	76	90	-	-	-	-	-	-
18Ton	AM216BXVTF*	60	208-230	22	22	4.2	4.2	62	70	28	28	4.2	4.2	76	90	-	-	-	-	-	-
20Ton	AM240BXVTF*	60	208-230	28	28	4.2	4.2	76	90	28	28	4.2	4.2	76	90	-	-	-	-	-	-
22Ton	AM264BXVTF*	60	208-230	18	18	4.2	4.2	50	60	18	18	4.2	4.2	50	60	28	28	4.2	4.2	76	90
24Ton	AM288BXVTF*	60	208-230	18	18	4.2	4.2	50	60	22	22	4.2	4.2	62	70	28	28	4.2	4.2	76	90
26Ton	AM312BXVTF*	60	208-230	18	18	4.2	4.2	50	60	28	28	4.2	4.2	76	90	28	28	4.2	4.2	76	90
28Ton	AM336BXVTF*	60	208-230	22	22	4.2	4.2	62	70	28	28	4.2	4.2	76	90	28	28	4.2	4.2	76	90
30Ton	AM360BXVTF*	60	208-230	28	28	4.2	4.2	76	90	28	28	4.2	4.2	76	90	28	28	4.2	4.2	76	90

2. Heat Pump / Heat Recovery (460V)

Nom. Ton	Model	Units		Module #1						Module #2						Module #3					
				RLA		FLA		Power Supply		RLA		FLA		Power Supply		RLA		FLA		Power Supply	
		Hz	Volts	Comp1	Comp2	FAN1	FAN2	MCA	MOP	Comp1	Comp2	FAN1	FAN2	MCA	MOP	Comp1	Comp2	FAN1	FAN2	MCA	MOP
6Ton	AM072BXVTJ*	60	460	9.2	9.2	2.1	2.1	25	30	-	-	-	-	-	-	-	-	-	-	-	-
8Ton	AM096BXVTJ*	60	460	11.0	11.0	2.1	2.1	31	35	-	-	-	-	-	-	-	-	-	-	-	-
10Ton	AM120BXVTJ*	60	460	14.0	14.0	2.1	2.1	38	45	-	-	-	-	-	-	-	-	-	-	-	-
12Ton	AM144BXVTJ*	60	460	9.2	9.2	2.1	2.1	25	30	9.2	9.2	2.1	2.1	25	30	-	-	-	-	-	-
14Ton	AM168BXVTJ*	60	460	9.2	9.2	2.1	2.1	25	30	11.0	11.0	2.1	2.1	31	35	-	-	-	-	-	-
16Ton	AM192BXVTJ*	60	460	9.2	9.2	2.1	2.1	25	30	14.0	14.0	2.1	2.1	38	45	-	-	-	-	-	-
18Ton	AM216BXVTJ*	60	460	11.0	11.0	2.1	2.1	31	35	14.0	14.0	2.1	2.1	38	45	-	-	-	-	-	-
20Ton	AM240BXVTJ*	60	460	14.0	14.0	2.1	2.1	38	45	14.0	14.0	2.1	2.1	38	45	-	-	-	-	-	-
22Ton	AM264BXVTJ*	60	460	9.2	9.2	2.1	2.1	25	30	9.2	9.2	2.1	2.1	25	30	14	14	2.1	2.1	38	45
24Ton	AM288BXVTJ*	60	460	9.2	9.2	2.1	2.1	25	30	11.0	11.0	2.1	2.1	31	35	14	14	2.1	2.1	38	45
26Ton	AM312BXVTJ*	60	460	9.2	9.2	2.1	2.1	25	30	14.0	14.0	2.1	2.1	38	45	14	14	2.1	2.1	38	45
28Ton	AM336BXVTJ*	60	460	11.0	11.0	2.1	2.1	31	35	14.0	14.0	2.1	2.1	38	45	14	14	2.1	2.1	38	45
30Ton	AM360BXVTJ*	60	460	14.0	14.0	2.1	2.1	38	45	14.0	14.0	2.1	2.1	38	45	14	14	2.1	2.1	38	45

NOTE

- RLA is based on AHRI 1230 Cooling Standard Condtn (Indoor Temp : 26.7°C / 80°F(DB) / 19.46°C / 67°F (WB), Outdoor Temp : 35°C / 95°F (DB))
- Voltage Tolerance is $\pm 10\%$
- Maximum allowable voltage between phases is 2%
- Refer to module combination table for independent units information
- Symbols :
 - RLA : Rated Load Ampere
 - FLA : Full Load Ampere
 - MCA : Minimum Circuit Ampere (A)
 - MOP : Maximum Overcurrent Protective Device (A)"

10. Installation

Electrical wiring work

⚠ CAUTION

- Caution for electrical work
 - You must install ELCB or MCCB + ELB
 - ELCB: Earth leakage breaker
 - MCCB: Molded case circuit breaker
 - ELB: Earth leakage breaker
 - Do not operate the outdoor unit before completing the refrigerant pipe work.
 - Do not disconnect or change the cable inside the product. It may cause damage to the product.
 - Specification of the power cable is selected based on following installation condition; culvert installation/ ambient temperature 30°C/ single multi conductor cables. If the condition is different from the ones stated, please consult an electrical installation expert and re-select the power cable.
 - If the length of power cable exceed 50m, re-select the power cable considering the voltage drop.
 - Use a power cable made out of incombustible material for the insulator (inner cover) and the sheath (outer cover).
 - Do not use the power cable with the core wire exposed due to insulator damage occurred during removal of the sheath. When the core wire is exposed, it may cause fire

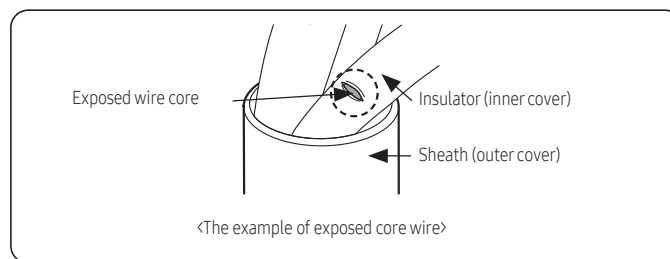

Power and communication cable configuration

- Main power and the ground cable must be withdrawn through the knock-out hole on the bottom-right or right side of the cabinet.
- Withdraw the communication cable from the designated knock-out hole on the bottom-right side of the front part.
- Install the power and communication cable using separate cable protection tube.
- Fix a protection tube to the knock-out hole on the outdoor unit by using a CD connector or bushing. Make sure to use insulating bushing.

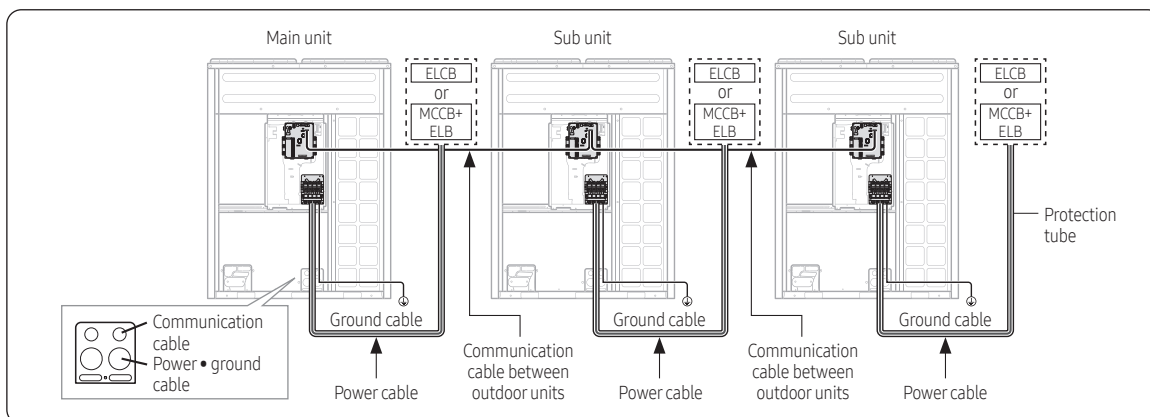

10. Installation

Specification of the protection tube

Name	Temper grade	Applicable conditions
Flexible PVC conduit	PVC	When the protection tube is installed indoor and not exposed to outside, because it is embedded in concrete structure
Class 1 flexible conduit	Galvanized steel sheet	When the protection tube is installed indoor but exposed to outside so there are risk of damage to the protection tube
Class 1 PVC coated flexible conduit	Galvanized steel sheet and Soft PVC compound	When the protection tube is installed outdoor and exposed to outside so there are risk of damage to the protection tube and extra waterproof is needed

CAUTION

- Caution for perforating the knock-out hole
- Perforate a knock-out hole by punching it with a hammer
- After perforating the knock-out hole, apply rust resisting paint around the hole.
- When you need to pass the cables through the knock-out hole, remove burrs on the hole and protection the cable with a protection tape or bushing etc.
- Caution for installing communication cable
- When you connect the cable, it may sag and pressed by other parts. Therefore cables should be fixed to a clamp highlighted with a box on the illustration.

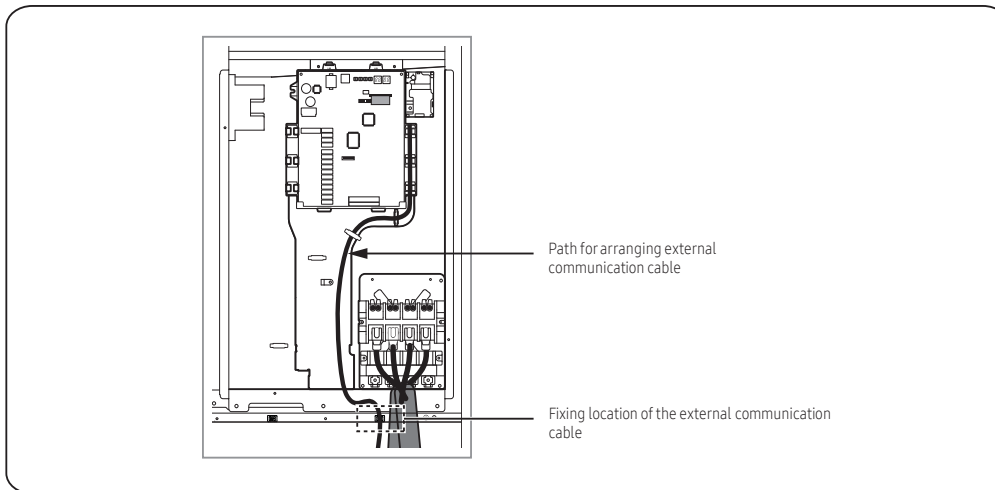

10. Installation

Power wiring diagram

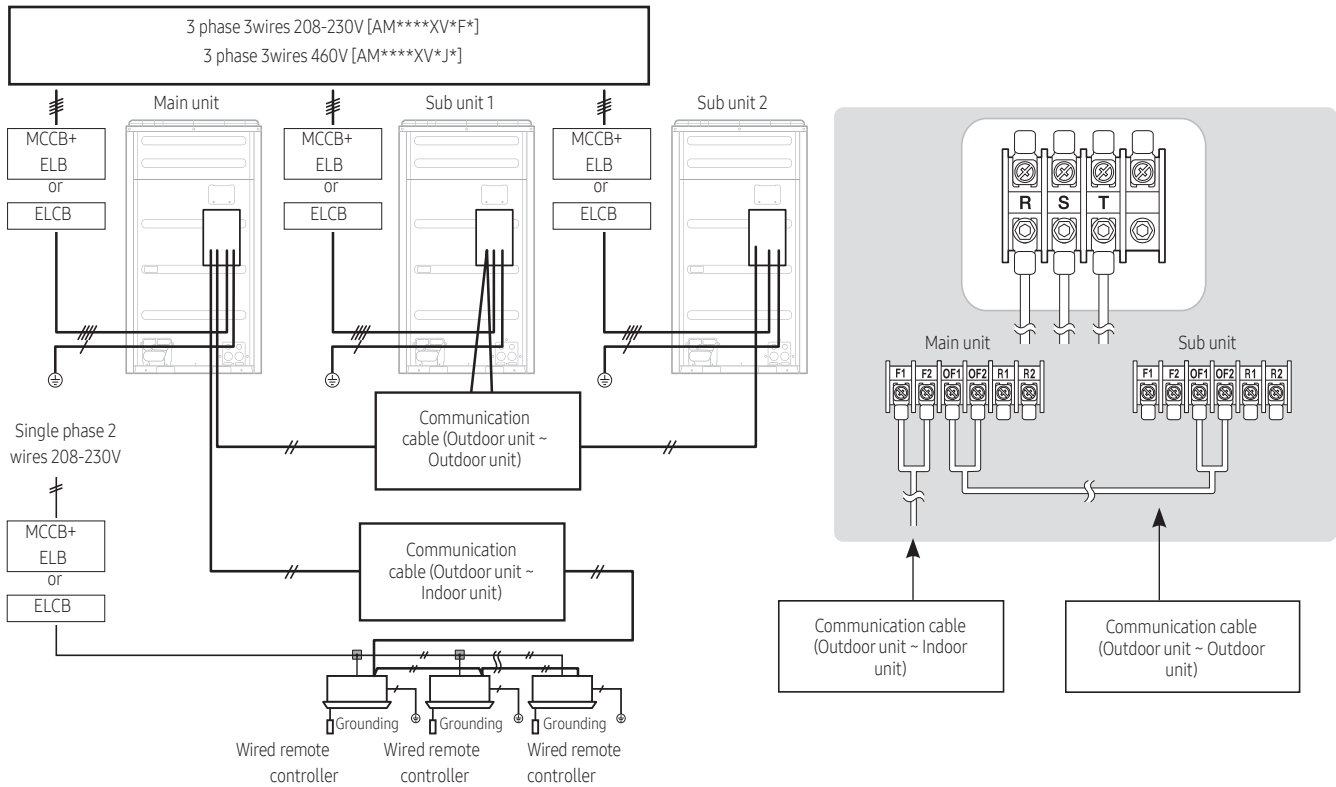

- Connect a power cable of the outdoor unit after checking that R-S-T (3 phase 3 wire) is properly connected.
- Malfunction may occur if one or more of the wires among R-S-T phases (3 Phases - 3 Wires) are not connected properly.
(*Malfunction : Turing on/off, occurrence of error, consecutive reset)
- Communication cable between indoor and outdoor units and communication cable between outdoor units has no polarity.
- Arrange the cables with a cable tie.
- ※ ELCB and ELB must be installed since there is risk of electric shock or fire when they are not installed.

10. Installation

Selecting solderless ring terminal

- Select a solderless ring terminal for a power cable according to the nominal dimensions for cable
- Apply insulation coating to the connection part of the solderless ring terminal and the power cable

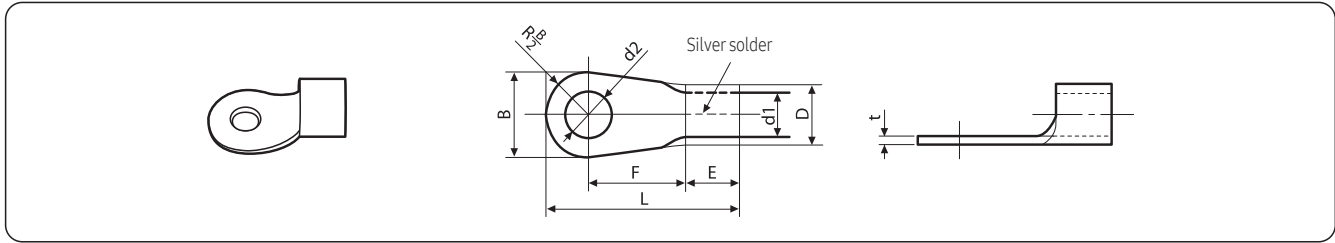

Nominal dimensions for cable [mm ² (inch ²)]		4/6 (0.006/0.009)		10 (0.01)	16 (0.02)	25 (0.03)		35 (0.05)		50 (0.07)	70 (0.10)
Nominal dimensions for screw [mm (inch)]		4 (3/8)	8 (3/16)	8 (3/16)	8 (3/16)	8 (3/16)	8 (3/16)	8 (3/16)	8 (3/16)	8 (3/16)	8 (3/16)
B	Standard dimension [mm (inch)]	9.5 (3/8)	15 (9/16)	15 (9/16)	16 (10/16)	12 (1/2)	16.5 (10/16)	16 (10/16)	22 (7/8)	22 (7/8)	24 (1)
	Allowance [mm (inch)]	±0.2 (±0.007)		±0.2 (±0.007)	±0.2 (±0.007)	±0.3 (±0.011)		±0.3 (±0.011)		±0.3 (±0.011)	±0.4 (±0.015)
D	Standard dimension [mm (inch)]	5.6 (1/4)		7.1 (1/4)	9 (3/8)	11.5 (7/16)		13.3 (1/2)		13.5 (1/2)	17.5 (1/2)
	Allowance [mm (inch)]	+0.3 (+0.011) -0.2 (-0.007)		+0.3 (+0.011) -0.2 (-0.007)	+0.3 (+0.011) -0.2 (-0.007)	+0.5 (+0.019) -0.2 (-0.007)		+0.5 (+0.019) -0.2 (-0.007)		+0.5 (+0.019) -0.2 (-0.007)	+0.5 (+0.019) -0.4 (-0.015)
d1	Standard dimension [mm (inch)]	3.4 (1/8)		4.5 (3/16)	5.8 (1/4)	7.7 (5/16)		9.4 (3/8)		11.4 (7/16)	13.3 (1/2)
	Allowance [mm (inch)]	±0.2 (±0.007)		±0.2 (±0.007)	±0.2 (±0.007)	±0.2 (±0.007)		±0.2 (±0.007)		±0.3 (±0.011)	±0.4 (±0.015)
E	Min. [mm (inch)]	6 (1/4)		7.9 (5/16)	9.5 (5/16)	11 (3/8)		12.5 (1/2)		17.5 (11/16)	18.5 (3/4)
F	Min. [mm (inch)]	5 (3/16)	9 (3/8)	9 (3/8)	13 (1/2)	15 (5/8)	13 (1/2)	13 (1/2)	13 (1/2)	14 (9/16)	20 (3/4)
L	Max. [mm (inch)]	20 (3/4)	28.5 (1-1/8)	30 (1-3/16)	33 (1-5/16)	34 (1-3/8)		38 (1-1/2)	43 (1-11/16)	50 (2)	51 (2)
d2	Standard dimension [mm (inch)]	4.3 (3/16)	8.4 (1-3/16)	8.4 (1-3/16)	8.4 (1-3/16)	8.4 (1-3/16)	8.4 (1-3/16)	8.4 (1-3/16)	8.4 (1-3/16)	8.4 (1-3/16)	8.4 (1-3/16)
	Allowance [mm (inch)]	+ 0.2 (+0.007) 0 (0)	+ 0.4 (+0.015) 0 (0)	+ 0.4 (+0.015) 0 (0)	+ 0.4 (+0.015) 0 (0)	+ 0.4 (+0.015) 0 (0)		+ 0.4 (+0.015) 0 (0)		+ 0.4 (+0.015) 0 (0)	+ 0.4 (+0.015) 0 (0)
t	Min. [mm (inch)]	0.9 (0.03)		1.15 (0.04)	1.45 (0.05)	1.7 (0.06)		1.8 (0.07)		1.8 (0.07)	2.0 (0.078)

10. Installation

Connecting the power terminal

- Connect the cables to the terminal board with solderless ring terminals.
- Properly connect the cables by using certified and rated cables and make sure to fix them properly so that external force is not applied to the terminal.
- Use a driver and wrench that can apply the rated torque when tightening the screws on the terminal board.
- Tighten the terminal screws by complying rated torque value. If the terminal is loose, fire can occur due to arc heat generation and if the terminal is too tight, terminal board could get damaged.

1 Front connection

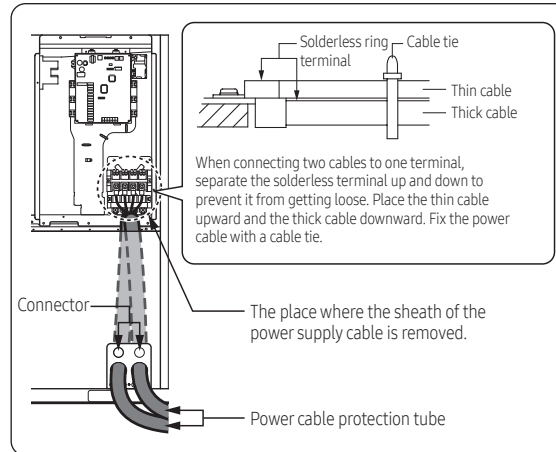

2 Closing the cover

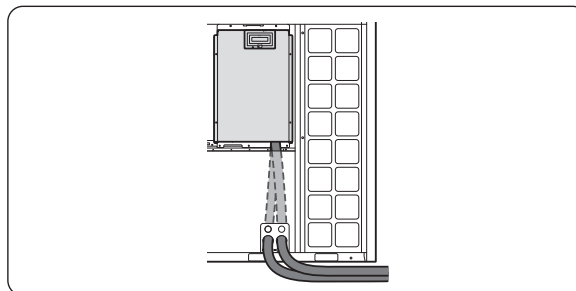

Screw	Tightening torque for terminal		Remarks
	N·m	lbf·ft	
M3.5	0.78~1.18	0.6~0.9	communication cable
M4	1.2~1.8	0.9~1.3	Single phase 208~230V power cable
M8	5.5~7.3	4.1~5.4	3 phase 208~230V / 460V power cable

CAUTION

- When removing the outer sheath of the power supply cable, be careful not to scratch the inner sheath of the cable.
- Make sure that more than 20mm (0.79inch) of the outer sheath of the indoor unit power and communication cable are inside the electrical component box.
- Install the communication cable separately from power cable and other communication cables.
- There is a risk of electric shock when power is applied. Close the cover of the control box before proceeding to work.
- To inspect the compressor or PBA, first make sure to turn off the system. Electricity may flow even in a compressor that has not been used recently. Exercise caution to protect yourself from an electric shock.

10. Installation

Fixing the power cable

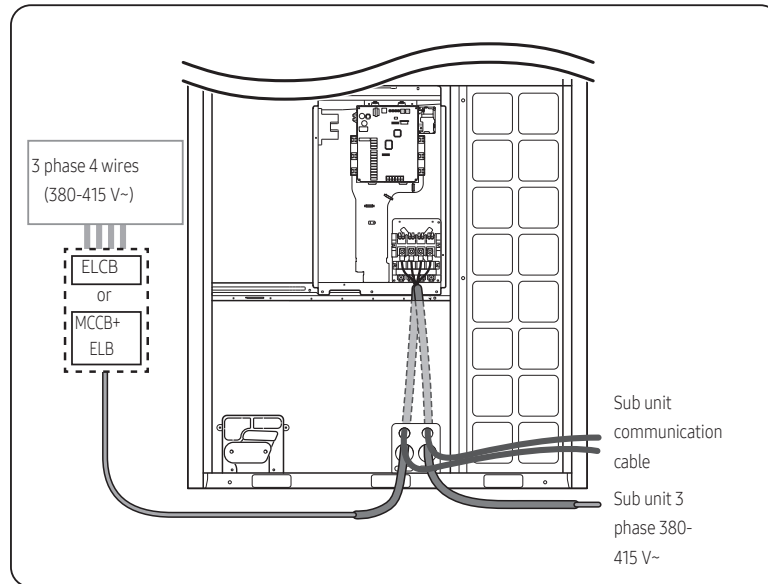

CAUTION

- Do not let the power cable come into contact with the pipes inside the outdoor unit. If the power supply cable touches the pipes, the vibration of the compressor is transferred to the pipes and can damage the power supply cables or pipes, creating the danger of fire or explosion.
- Make sure that the place where the sheath of power supply cable is removed is inside the power supply box. If it is impossible, you should connect the protection tube for power cable to the power supply box.
- After arranging the power cable into the power supply box, tighten the cover.

10. Installation

Connect the ring terminal of 3 phase cable

- 1 Cut the power cable to an appropriate length and connect it with the solderless terminal.
- 2 After connecting the power cable to the terminal as seen in the illustration, fix it with cable tie.
- 3 Fix the housing, which has an insulator, to the terminal board.

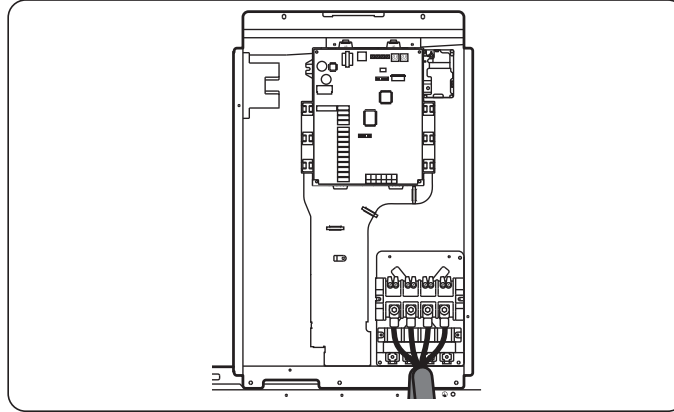

Fixing the ground cable

- Connect the ground cable to the grounding hole inside the power supply box

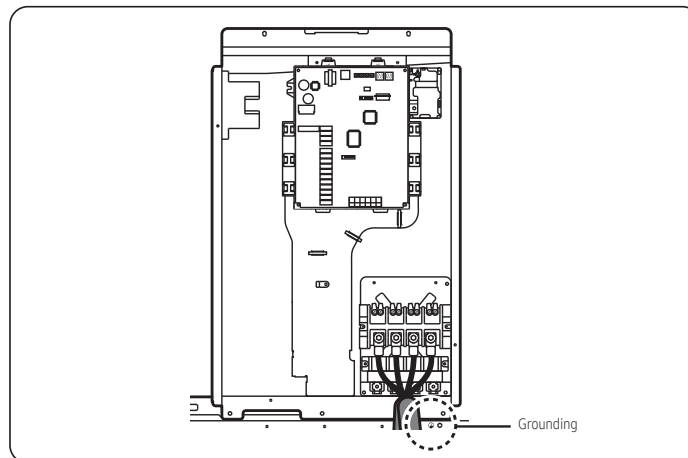

Withdrawing the power cable

- Withdrawing from the front side
 - Connect the power cable protection tube into the power supply box as shown picture.
 - Be sure that the power supply cable is not damaged by burr on the knock-out hole.

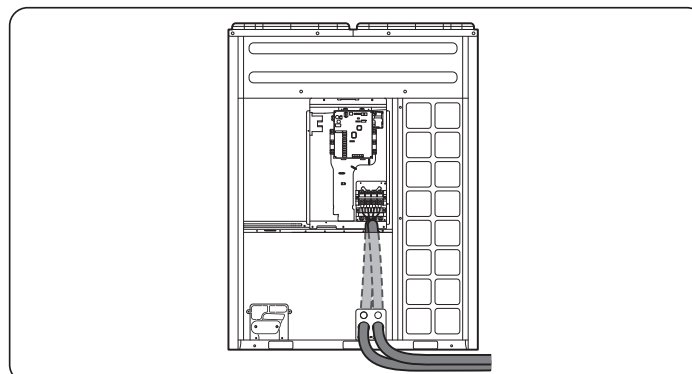

10. Installation

Installing the Solution device

When the number of indoor units installed with the outdoor unit is 16 or less

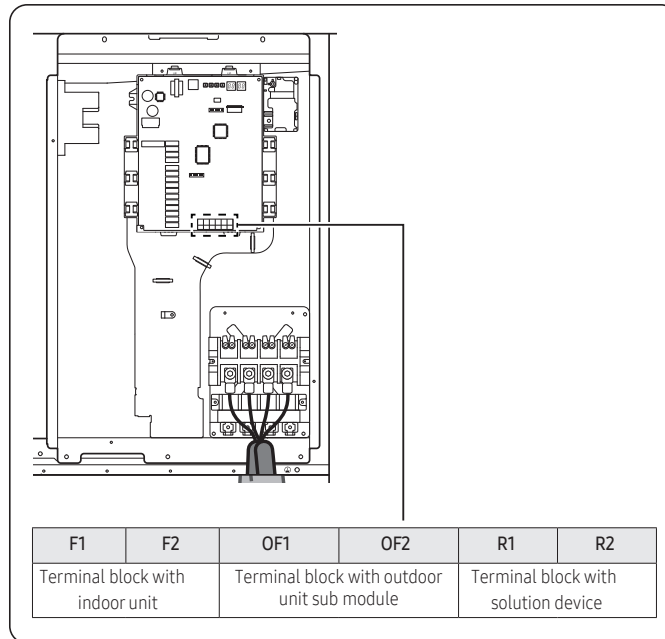

Where to install the interface module

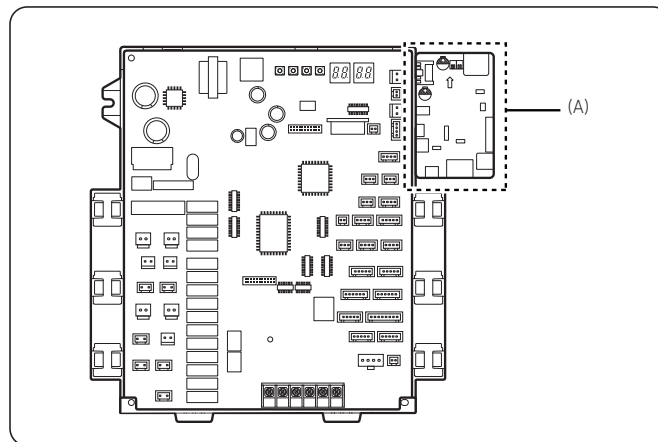

- Install the interface module in location (A), considering the installation conditions.
– For details on how to install, refer to the interface module installation manual.

11. AHRI Data

Model	Rated Capacity (Btu/h)		EER (Btu/h)		IEER (Btu/h)		COP (W/W)		Low COP(17F) (W/W)		SCHE (Btu/h/W)	
	Cooling	Heating	Non-Ducted	Ducted	Non-Ducted	Ducted	Non-Ducted	Ducted	Non-Ducted	Ducted	Non-Ducted	Ducted
AM072BXVT**	69,000	77,000	14.43	12.66	34.60	24.70	4.55	4.14	2.69	2.46	29.80	26.10
AM096BXVT**	92,000	103,000	14.75	12.81	36.10	26.10	4.42	3.94	2.60	2.47	29.60	26.40
AM120BXVT**	114,000	129,000	13.86	12.65	33.60	26.20	4.33	3.92	2.08	2.32	29.40	25.60
AM144BXVT**	138,000	154,000	14.00	12.28	32.90	21.10	4.28	3.89	2.56	2.34	27.70	25.80
AM168BXVT**	160,000	180,000	14.01	12.23	33.20	24.10	4.17	3.86	2.49	2.32	26.80	24.80
AM192BXVT**	182,000	206,000	13.58	12.15	32.10	24.10	4.13	3.83	2.27	2.27	25.90	23.90
AM216BXVT**	206,000	232,000	13.59	12.09	31.70	24.10	4.03	3.81	2.18	2.23	26.40	23.90
AM240BXVT**	228,000	258,000	13.17	12.02	31.60	24.00	3.98	3.80	2.06	2.16	23.40	23.40
AM264BXVT**	252,000	282,000	13.10	11.58	31.50	23.40	3.76	3.74	2.31	2.15	23.50	23.00
AM288BXVT**	274,000	308,000	12.91	11.5	31.30	23.00	3.68	3.60	2.28	2.13	23.80	22.00
AM312BXVT**	296,000	334,000	12.36	11.13	29.90	22.60	3.61	3.51	2.12	2.11	24.50	21.39
AM336BXVT**	320,000	360,000	12.17	10.92	29.60	22.30	3.53	3.38	2.07	2.09	24.20	21.21
AM360BXVT**	342,000	386,000	11.64	10.63	28.20	22.00	3.46	3.33	2.06	2.06	23.80	20.74

2022.12
Ver.2.1

Samsung Electronics Co., LTD.

Head Office (Suwon Korea) 129, Samsung-Ro, Yeongtong-Gu, Suwon City, Gyeonggi-Do, Korea 16677
Website : www.samsung.com, <https://partnerhub.samsung.com> E-mail : airconditioner@samsung.com
Images and data in this book may subject to change without prior notice.