

VRF

Technical Data Book

DVM S IDU for NA (Floor Standing)

SAMSUNG

Model Names

AM	006	J	N	F	D	C	H	/	AA
(1)	(2)	(3)	(4)	(5)	(6)	(7)	(8)		Buyer

(1) Classification

AM	DVM
----	-----

(2) Capacity

kBtu/h (3digits)

(3) Version

F	2013
H	2014
J	2015

(4) Product type

X	Outdoor unit
N	Indoor unit

(5) Feature 1

F	Concealed Floor Mounting
G	Floor Mounting

(6) Feature 2

D	DELUXE
---	--------

(7) Power supply (Φ , V, Hz)

C	1, 208~230, 60
F	3, 208~230, 60

(8) Mode

H	Heat pump
R	Heat recovery

Floor standing

Type			Concealed	Floor Standing	Concealed	Floor Standing
Model Name			AM006JNFDCH/AA	AM006JNGDCH/AA	AM009JNFDCH/AA	AM009JNGDCH/AA
Power Supply		Ø, #, V, Hz	1,2,208-230,60	1,2,208-230,60	1,2,208-230,60	1,2,208-230,60
Mode			-	HP/HR	HP/HR	HP/HR
Performance	Ton		0.50	0.50	0.79	0.79
		Capacity (Nominal)	Cooling	kW	1.76	1.76
	Btu/h			6,000	6,000	9,500
	Heating		US RT	0.50	0.50	0.79
			kW	1.96	1.96	3.08
	Btu/h	6,700	6,700	10,500		
US RT	0.56	0.56	0.87			
Power	Power Input (Nominal)	Cooling	W	35.00	35.00	40.00
		Heating	W	35.00	35.00	40.00
	Current Input (Nominal)	Cooling	A	0.20	0.20	0.22
		Heating	A	0.20	0.20	0.22
Fan	Motor	Type	-	Sirocco Fan	Sirocco Fan	Sirocco Fan
		Output x n	W	10 x 1	10 x 1	10 x 1
	Air Flow	H/M/L (UL)	CFM	175.00 / 140.00 / 105.00	175.00 / 140.00 / 105.00	250.00 / 195.00 / 160.00
	External Pressure	Min / Std / Max	Pa	-	-	-
			In Wg	-	-	-
Piping Connections	Liquid Pipe	Ø, mm	6.35	6.35	6.35	
		Ø, inch	1/4"	1/4"	1/4"	
	Gas Pipe	Ø, mm	12.70	12.70	12.70	
		Ø, inch	1/2"	1/2"	1/2"	
	Drain Pipe	Ø, mm	ID18 HOSE	ID18 HOSE	ID18 HOSE	
Field Wiring	Power Source Wire	mm ²	2.5	2.5	2.5	
	Transmission Cable	mm ²	0.75 - 1.50	0.75 - 1.50	0.75 - 1.50	
Refrigerant	Type	-	R410A	R410A	R410A	
	Control Method	-	EEV INCLUDED	EEV INCLUDED	EEV INCLUDED	
Sound	Pressure	High / Mid / Low	dB(A)	23 / 22 / 20	23 / 22 / 20	26 / 24 / 21
	Power	Cooling		-	-	-
Dimensions	Net Weight	kg	23.00	25.99	23.00	
		lbs	50.70	57.30	50.70	
	Shipping Weight	kg	26.99	29.48	26.99	
		lbs	59.50	65.00	59.50	
	Net Dimensions (WxHxD)	mm	945 x 600 x 220	1,168 x 600 x 220	944 x 600 x 220	
		inch	37.20 x 23.62 x 8.66	45.98 x 23.62 x 8.66	37.17 x 23.62 x 8.66	
	Shipping Dimensions (WxHxD)	mm	1,035 x 690 x 310	1,255 x 690 x 310	1,035 x 690 x 310	
inch		40.75 x 27.17 x 12.20	49.41 x 27.17 x 12.20	40.75 x 27.17 x 12.20		
Panel Size	Panel Model	-	-	-	-	
	Panel Net Weight	kg	-	-	-	
		lbs	-	-	-	
	Shipping Weight	kg	-	-	-	
		lbs	-	-	-	
	Net Dimensions (WxHxD)	mm	-	-	-	
		inch	-	-	-	
	Shipping Dimensions (WxHxD)	mm	-	-	-	
inch		-	-	-		
Additional Accessories	Drain pump	Drain pump	-	-	-	
		Max. lifting Height / Displacement	mm / liter / h	-	-	
	Air Filter	-	Long Life Filter	Long Life Filter	Long Life Filter	

- Nominal capacity are based on (Refrigerant Piping : 25ft , Level Differences : 0ft);

.Cooling : Indoor temperature : 80°F DB, 67°F WB / Outdoor temperature : 95°F DB, 75°F WB

.Heating : Indoor temperature : 70°F DB, 60°F WB / Outdoor temperature : 47°F DB, 43°F WB

- Sound pressure was acquired in a dead room. Thus actual noise level may be different depending on the installation conditions.

- Specifications are subject to change without prior notice for product improvement.

Floor standing

Type			Concealed	Floor Standing	Concealed	Floor Standing	
Model Name			AM012JNFDCH/AA	AM012JNGDCH/AA	AM018JNFDCH/AA	AM018JNGDCH/AA	
Power Supply		Ø, #, V, Hz	1,2,208-230,60	1,2,208-230,60	1,2,208-230,60	1,2,208-230,60	
Mode			-	HP/HR	HP/HR	HP/HR	
Performance	Ton		1.00	1.00	1.50	1.50	
		Capacity (Nominal)	Cooling	kW	3.52	3.52	5.28
	Btu/h			12,000	12,000	18,000	18,000
	Heating		US RT	1.00	1.00	1.50	1.50
			kW	3.96	3.96	5.86	5.86
	Btu/h	13,500	13,500	20,000	20,000		
US RT	1.13	1.13	1.67	1.67			
Power	Power Input (Nominal)	Cooling	W	50.00	50.00	110.00	110.00
		Heating		50.00	50.00	110.00	110.00
	Current Input (Nominal)	Cooling	A	0.24	0.24	0.53	0.53
		Heating		0.24	0.24	0.53	0.53
Fan	Motor	Type	-	Sirocco Fan	Sirocco Fan	Sirocco Fan	Sirocco Fan
		Output x n	W	10 x 1	10 x 1	50 x 1	50 x 1
	Air Flow	H/M/L (UL)	CFM	350.00 / 300.00 / 210.00	350.00 / 300.00 / 210.00	550.00 / 495.00 / 390.00	550.00 / 495.00 / 390.00
	External Pressure	Min / Std / Max	Pa	-	-	-	-
			In Wg	-	-	-	-
Piping Connections	Liquid Pipe	Ø, mm	6.35	6.35	6.35	6.35	
		Ø, inch	1/4"	1/4"	1/4"	1/4"	
	Gas Pipe	Ø, mm	12.70	12.70	12.70	12.70	
		Ø, inch	1/2"	1/2"	1/2"	1/2"	
	Drain Pipe	Ø, mm	ID18 HOSE	ID18 HOSE	ID18 HOSE	ID18 HOSE	
Field Wiring	Power Source Wire	mm ²	2.5	2.5	2.5	2.5	
	Transmission Cable	mm ²	0.75 - 1.50	0.75 - 1.50	0.75 - 1.50	0.75 - 1.50	
Refrigerant	Type	-	R410A	R410A	R410A	R410A	
	Control Method	-	EEV INCLUDED	EEV INCLUDED	EEV INCLUDED	EEV INCLUDED	
Sound	Pressure	High / Mid / Low	dB(A)	37 / 32 / 27	37 / 32 / 27	40 / 36 / 32	40 / 36 / 32
	Power	Cooling		-	-	-	-
Dimensions	Net Weight	kg	23.00	25.99	28.49	31.48	
		lbs	50.70	57.30	62.80	69.40	
	Shipping Weight	kg	26.99	29.48	33.48	36.51	
		lbs	59.50	65.00	73.80	80.50	
	Net Dimensions (WxHxD)	mm	944 x 600 x 220	1,168 x 600 x 220	1,225 x 600 x 220	1,449 x 600 x 220	
		inch	37.17 x 23.62 x 8.66	45.98 x 23.62 x 8.66	48.23 x 23.62 x 8.66	57.05 x 23.62 x 8.66	
	Shipping Dimensions (WxHxD)	mm	1,035 x 690 x 310	1,255 x 690 x 310	1,335 x 690 x 310	1,534 x 690 x 310	
		inch	40.75 x 27.17 x 12.20	49.41 x 27.17 x 12.20	52.56 x 27.17 x 12.20	60.39 x 27.17 x 12.20	
Panel Size	Panel Model	-	-	-	-	-	
	Panel Net Weight	kg	-	-	-	-	
		lbs	-	-	-	-	
	Shipping Weight	kg	-	-	-	-	
		lbs	-	-	-	-	
	Net Dimensions (WxHxD)	mm	-	-	-	-	
		inch	-	-	-	-	
	Shipping Dimensions (WxHxD)	mm	-	-	-	-	
inch		-	-	-	-		
Additional Accessories	Drain pump	Drain pump	-	-	-	-	
		Max. lifting Height / Displacement	mm / liter / h	-	-	-	-
	Air Filter	-	Long Life Filter	Long Life Filter	Long Life Filter	Long Life Filter	

- Nominal capacity are based on (Refrigerant Piping : 25ft , Level Differences : 0ft);

.Cooling : Indoor temperature : 80°F DB, 67°F WB / Outdoor temperature : 95°F DB, 75°F WB

.Heating : Indoor temperature : 70°F DB, 60°F WB / Outdoor temperature : 47°F DB, 43°F WB

- Sound pressure was acquired in a dead room. Thus actual noise level may be different depending on the installation conditions.

- Specifications are subject to change without prior notice for product improvement.

Floor standing

Type			Concealed	Floor Standing	
Model Name			AM024JNFDCH/AA	AM024JNGDCH/AA	
Power Supply		Ø, #, V, Hz	1,2,208-230,60	1,2,208-230,60	
Mode			HP/HR	HP/HR	
Performance	Ton		2.00	2.00	
	Capacity (Nominal)	Cooling	kW	7.03	7.03
			Btu/h	24,000	24,000
		Heating	US RT	2.00	2.00
			kW	7.91	7.91
			US RT	2.25	2.25
Power	Power Input (Nominal)	Cooling	W	110.00	110.00
		Heating	W	110.00	110.00
	Current Input (Nominal)	Cooling	A	0.53	0.53
		Heating	A	0.53	0.53
Fan	Motor	Type	-	Sirocco Fan	Sirocco Fan
		Output x n	W	50 x 1	50 x 1
	Air Flow	H/M/L (UL)	CFM	550.00 / 495.00 / 390.00	550.00 / 495.00 / 390.00
	External Pressure	Min / Std / Max	Pa	-	-
			In Wg	-	-
Piping Connections	Liquid Pipe		Ø, mm	9.52	9.52
			Ø, inch	3/8"	3/8"
	Gas Pipe		Ø, mm	15.88	15.88
			Ø, inch	5/8"	5/8"
	Drain Pipe	Ø, mm	ID18 HOSE	ID18 HOSE	
Field Wiring	Power Source Wire		mm ²	2.5	2.5
	Transmission Cable		mm ²	0.75 - 1.50	0.75 - 1.50
Refrigerant	Type		-	R410A	R410A
	Control Method		-	EEV INCLUDED	EEV INCLUDED
Sound	Pressure	High / Mid / Low	dB(A)	40 / 36 / 32	40 / 36 / 32
	Power	Cooling		-	-
Dimensions	Net Weight		kg	28.49	31.48
			lbs	62.80	69.40
	Shipping Weight		kg	33.48	36.51
			lbs	73.80	80.50
	Net Dimensions (WxHxD)		mm	1,225 x 600 x 220	1,449 x 600 x 220
			inch	48.23 x 23.62 x 8.66	57.05 x 23.62 x 8.66
	Shipping Dimensions (WxHxD)		mm	1,335 x 690 x 310	1,534 x 690 x 310
			inch	52.56 x 27.17 x 12.20	60.39 x 27.17 x 12.20
Panel Size	Panel Model		-	-	-
	Panel Net Weight		kg	-	-
			lbs	-	-
	Shipping Weight		kg	-	-
			lbs	-	-
	Net Dimensions (WxHxD)		mm	-	-
			inch	-	-
	Shipping Dimensions (WxHxD)		mm	-	-
inch			-	-	
Additional Accessories	Drain pump	Drain pump	-	-	
		Max. lifting Height / Displacement	mm / liter / h	-	-
	Air Filter		-	Long Life Filter	Long Life Filter

- Nominal capacity are based on (Refrigerant Piping : 25ft , Level Differences : 0ft);

.Cooling : Indoor temperature : 80°F DB, 67°F WB / Outdoor temperature : 95°F DB, 75°F WB

.Heating : Indoor temperature : 70°F DB, 60°F WB / Outdoor temperature : 47°F DB, 43°F WB

- Sound pressure was acquired in a dead room. Thus actual noise level may be different depending on the installation conditions.

- Specifications are subject to change without prior notice for product improvement.

Capacity table

Floor standing

Cooling

TC : Total Capacity, SHC : Sensible Heat Capacity

Model	Outdoor temperature (°F, DB)	Indoor temperature (°F, WB)													
		57.0		61.0		64.0		67.0		70.0		72.0		75.0	
		TC	SHC	TC	SHC	TC	SHC	TC	SHC	TC	SHC	TC	SHC	TC	SHC
AM024JNFDCH/AA	50.0	16.60	14.50	19.60	16.90	22.60	17.50	24.00	18.20	25.00	18.90	27.00	19.20	28.70	18.20
	54.0	16.60	14.50	19.60	16.90	22.60	17.50	24.00	18.20	25.00	18.90	26.70	18.90	28.70	18.20
	58.0	16.60	14.50	19.60	16.90	22.60	17.50	24.00	18.20	25.00	18.90	26.70	18.90	28.70	18.20
	60.0	16.60	14.50	19.60	16.90	22.60	17.50	24.00	18.20	25.00	18.90	26.70	18.90	28.40	17.90
	64.0	16.60	14.50	19.60	16.90	22.60	17.50	24.00	18.20	25.00	18.90	26.70	18.90	28.40	17.90
	67.0	16.60	14.50	19.60	16.90	22.60	17.50	24.00	18.20	25.00	18.90	26.70	18.90	28.40	17.90
	70.0	16.60	14.50	19.60	16.90	22.60	17.50	24.00	18.20	25.00	18.90	26.70	18.90	28.40	17.90
	73.0	16.60	14.50	19.60	16.90	22.60	17.50	24.00	18.20	25.00	18.90	26.70	18.90	28.40	17.90
	77.0	16.60	14.50	19.60	16.90	22.60	17.50	24.00	18.20	25.00	18.90	26.70	18.90	28.40	17.90
	80.0	16.60	14.50	19.60	16.90	22.60	17.50	24.00	18.20	25.00	18.90	26.70	18.90	28.40	17.90
	84.0	16.60	14.50	19.60	16.90	22.60	17.50	24.00	18.20	25.00	18.90	26.70	18.90	28.40	17.90
	88.0	16.60	14.50	19.60	16.90	22.60	17.50	24.00	18.20	25.00	18.90	26.70	18.90	28.40	17.90
	92.0	16.60	14.50	19.60	16.90	22.60	17.50	24.00	18.20	25.00	18.90	26.70	18.90	28.40	17.90
	95.0	16.60	14.50	19.60	16.90	22.60	17.50	24.00	18.20	25.00	18.90	26.70	18.90	28.40	17.90
	99.0	16.60	14.50	19.60	16.90	22.60	17.50	24.00	18.20	24.70	18.50	26.40	18.50	27.70	17.50
	103.0	16.60	14.50	19.60	16.90	22.60	17.50	24.00	18.20	24.70	18.50	26.00	18.20	27.40	17.20
	107.0	16.60	14.50	19.60	16.90	22.50	17.40	23.70	18.00	24.40	18.30	25.60	17.90	26.70	16.80
	111.0	16.60	14.50	19.60	16.90	21.90	16.90	22.90	17.40	23.70	17.80	24.60	17.20	25.80	16.20
115.0	16.60	14.50	19.40	16.70	21.50	16.70	22.20	16.80	23.00	17.30	23.80	16.60	25.10	15.70	
118.0	16.40	14.30	19.20	16.50	21.20	16.40	21.60	16.40	22.50	16.90	23.10	16.10	24.20	15.20	
120.0	16.10	14.10	18.90	16.30	20.70	16.00	21.40	16.20	21.80	16.40	22.20	15.50	23.30	14.60	
AM024JNGDCH/AA	50.0	16.60	14.50	19.60	16.90	22.60	17.50	24.00	18.20	25.00	18.90	27.00	19.20	28.70	18.20
	54.0	16.60	14.50	19.60	16.90	22.60	17.50	24.00	18.20	25.00	18.90	26.70	18.90	28.70	18.20
	58.0	16.60	14.50	19.60	16.90	22.60	17.50	24.00	18.20	25.00	18.90	26.70	18.90	28.70	18.20
	60.0	16.60	14.50	19.60	16.90	22.60	17.50	24.00	18.20	25.00	18.90	26.70	18.90	28.40	17.90
	64.0	16.60	14.50	19.60	16.90	22.60	17.50	24.00	18.20	25.00	18.90	26.70	18.90	28.40	17.90
	67.0	16.60	14.50	19.60	16.90	22.60	17.50	24.00	18.20	25.00	18.90	26.70	18.90	28.40	17.90
	70.0	16.60	14.50	19.60	16.90	22.60	17.50	24.00	18.20	25.00	18.90	26.70	18.90	28.40	17.90
	73.0	16.60	14.50	19.60	16.90	22.60	17.50	24.00	18.20	25.00	18.90	26.70	18.90	28.40	17.90
	77.0	16.60	14.50	19.60	16.90	22.60	17.50	24.00	18.20	25.00	18.90	26.70	18.90	28.40	17.90
	80.0	16.60	14.50	19.60	16.90	22.60	17.50	24.00	18.20	25.00	18.90	26.70	18.90	28.40	17.90
	84.0	16.60	14.50	19.60	16.90	22.60	17.50	24.00	18.20	25.00	18.90	26.70	18.90	28.40	17.90
	88.0	16.60	14.50	19.60	16.90	22.60	17.50	24.00	18.20	25.00	18.90	26.70	18.90	28.40	17.90
	92.0	16.60	14.50	19.60	16.90	22.60	17.50	24.00	18.20	25.00	18.90	26.70	18.90	28.40	17.90
	95.0	16.60	14.50	19.60	16.90	22.60	17.50	24.00	18.20	25.00	18.90	26.70	18.90	28.40	17.90
	99.0	16.60	14.50	19.60	16.90	22.60	17.50	24.00	18.20	24.70	18.50	26.40	18.50	27.70	17.50
	103.0	16.60	14.50	19.60	16.90	22.60	17.50	24.00	18.20	24.70	18.50	26.00	18.20	27.40	17.20
	107.0	16.60	14.50	19.60	16.90	22.50	17.40	23.70	18.00	24.40	18.30	25.60	17.90	26.70	16.80
	111.0	16.60	14.50	19.60	16.90	21.90	16.90	22.90	17.40	23.70	17.80	24.60	17.20	25.80	16.20
115.0	16.60	14.50	19.40	16.70	21.50	16.70	22.20	16.80	23.00	17.30	23.80	16.60	25.10	15.70	
118.0	16.40	14.30	19.20	16.50	21.20	16.40	21.60	16.40	22.50	16.90	23.10	16.10	24.20	15.20	
120.0	16.10	14.10	18.90	16.30	20.70	16.00	21.40	16.20	21.80	16.40	22.20	15.50	23.30	14.60	

Capacity table

Floor standing

Heating

TC : Total Capacity

Model	Outdoor temperature (°F)		Indoor temperature (°F, DB)				
			61.0	65.0	70.0	72.0	75.0
	DB	WB	TC	TC	TC	TC	TC
AM006JNFDCH/AA	-12.6	-13.0	3.59	3.59	3.59	3.59	3.59
	-7.1	-7.6	3.86	3.86	3.86	3.86	3.86
	-3.6	-4.0	4.04	4.04	4.04	4.04	4.04
	-1.8	-2.2	4.13	4.13	4.13	4.13	4.13
	2.0	1.0	4.33	4.29	4.29	4.29	4.29
	6.0	5.0	4.58	4.34	4.34	4.34	4.31
	10.0	9.0	4.77	4.72	4.72	4.72	4.50
	13.0	12.0	5.23	5.23	5.03	5.03	4.96
	17.0	15.0	5.49	5.45	5.23	5.14	5.14
	19.0	18.0	5.76	5.63	5.49	5.23	5.23
	23.0	21.0	6.16	5.90	5.90	5.36	5.36
	26.0	24.0	6.43	6.16	6.16	5.90	5.90
	30.0	28.0	6.70	6.70	6.43	6.16	5.90
	35.0	32.0	6.97	6.70	6.70	6.16	5.90
	39.0	36.0	7.24	6.97	6.70	6.16	5.90
	44.0	40.0	7.50	7.24	6.70	6.16	5.90
	47.0	43.0	7.50	7.24	6.70	6.16	5.90
	51.0	47.0	8.04	7.24	6.70	6.16	5.90
	54.0	50.0	8.04	7.24	6.70	6.16	5.90
57.0	53.0	8.04	7.24	6.70	6.16	5.90	
60.0	56.0	8.04	7.24	6.70	6.16	5.90	
AM006JNGDCH/AA	-12.6	-13.0	3.59	3.59	3.59	3.59	3.59
	-7.1	-7.6	3.86	3.86	3.86	3.86	3.86
	-3.6	-4.0	4.04	4.04	4.04	4.04	4.04
	-1.8	-2.2	4.13	4.13	4.13	4.13	4.13
	2.0	1.0	4.33	4.29	4.29	4.29	4.29
	6.0	5.0	4.58	4.34	4.34	4.34	4.31
	10.0	9.0	4.77	4.72	4.72	4.72	4.50
	13.0	12.0	5.23	5.23	5.03	5.03	4.96
	17.0	15.0	5.49	5.45	5.23	5.14	5.14
	19.0	18.0	5.76	5.63	5.49	5.23	5.23
	23.0	21.0	6.16	5.90	5.90	5.36	5.36
	26.0	24.0	6.43	6.16	6.16	5.90	5.90
	30.0	28.0	6.70	6.70	6.43	6.16	5.90
	35.0	32.0	6.97	6.70	6.70	6.16	5.90
	39.0	36.0	7.24	6.97	6.70	6.16	5.90
	44.0	40.0	7.50	7.24	6.70	6.16	5.90
	47.0	43.0	7.50	7.24	6.70	6.16	5.90
	51.0	47.0	8.04	7.24	6.70	6.16	5.90
	54.0	50.0	8.04	7.24	6.70	6.16	5.90
57.0	53.0	8.04	7.24	6.70	6.16	5.90	
60.0	56.0	8.04	7.24	6.70	6.16	5.90	
AM009JNFDCH/AA	-12.6	-13.0	5.71	5.71	5.71	5.71	6.23
	-7.1	-7.6	6.04	6.04	6.04	6.04	6.23
	-3.6	-4.0	6.26	6.26	6.26	6.26	6.23
	-1.8	-2.2	6.37	6.37	6.37	6.37	6.23
	2.0	1.0	6.61	6.61	6.56	6.56	6.23
	6.0	5.0	6.92	6.92	6.63	6.59	6.30
	10.0	9.0	7.15	7.15	7.09	6.82	6.76
	13.0	12.0	7.47	7.47	7.47	7.38	7.14
	17.0	15.0	7.66	7.60	7.60	7.60	7.27
	19.0	18.0	7.87	7.71	7.71	7.71	7.38
	23.0	21.0	8.20	7.87	7.87	7.87	7.55
	26.0	24.0	8.53	8.53	8.20	8.20	7.87
	30.0	28.0	9.19	8.86	8.86	8.53	8.20
	35.0	32.0	9.52	9.19	9.19	8.86	8.53
	39.0	36.0	9.84	9.84	9.52	9.19	8.86
	44.0	40.0	10.50	10.17	10.17	9.52	8.86
	47.0	43.0	10.83	10.50	10.50	9.84	8.86
	51.0	47.0	11.16	10.83	10.50	9.84	8.86
	54.0	50.0	11.48	10.83	10.50	9.84	8.86
57.0	53.0	11.81	11.16	10.50	9.84	8.86	
60.0	56.0	12.14	11.16	10.50	9.84	8.86	
AM009JNGDCH/AA	-12.6	-13.0	5.71	5.71	5.71	5.71	6.23
	-7.1	-7.6	6.04	6.04	6.04	6.04	6.23
	-3.6	-4.0	6.26	6.26	6.26	6.26	6.23
	-1.8	-2.2	6.37	6.37	6.37	6.37	6.23
	2.0	1.0	6.61	6.61	6.56	6.56	6.23
	6.0	5.0	6.92	6.92	6.63	6.59	6.30
	10.0	9.0	7.15	7.15	7.09	6.82	6.76
	13.0	12.0	7.47	7.47	7.47	7.38	7.14
	17.0	15.0	7.66	7.60	7.60	7.60	7.27
	19.0	18.0	7.87	7.71	7.71	7.71	7.38
	23.0	21.0	8.20	7.87	7.87	7.87	7.55
	26.0	24.0	8.53	8.53	8.20	8.20	7.87
	30.0	28.0	9.19	8.86	8.86	8.53	8.20
	35.0	32.0	9.52	9.19	9.19	8.86	8.53
	39.0	36.0	9.84	9.84	9.52	9.19	8.86
	44.0	40.0	10.50	10.17	10.17	9.52	8.86
	47.0	43.0	10.83	10.50	10.50	9.84	8.86
	51.0	47.0	11.16	10.83	10.50	9.84	8.86
	54.0	50.0	11.48	10.83	10.50	9.84	8.86
57.0	53.0	11.81	11.16	10.50	9.84	8.86	
60.0	56.0	12.14	11.16	10.50	9.84	8.86	

Floor standing

Heating

TC : Total Capacity

Model	Outdoor temperature (°F)		Indoor temperature (°F, DB)				
			61.0	65.0	70.0	72.0	75.0
	DB	WB	TC	TC	TC	TC	TC
AM012JNFDCH/AA	-12.6	-13.0	7.02	7.56	7.22	7.22	7.76
	-7.1	-7.6	7.70	7.90	7.56	7.56	7.76
	-3.6	-4.0	8.15	8.12	7.79	7.79	7.76
	-1.8	-2.2	8.37	8.23	7.90	7.90	7.76
	2.0	1.0	8.83	8.49	8.15	8.15	7.81
	6.0	5.0	9.15	8.81	8.51	8.47	8.17
	10.0	9.0	9.38	9.04	8.98	8.71	8.64
	13.0	12.0	9.70	9.62	9.62	9.28	9.28
	17.0	15.0	9.90	9.90	9.84	9.56	9.51
	19.0	18.0	10.12	10.12	9.96	9.79	9.62
	23.0	21.0	10.46	10.46	10.12	10.12	9.79
	26.0	24.0	11.14	10.80	10.80	10.46	10.12
	30.0	28.0	11.48	11.48	11.14	10.80	10.46
	35.0	32.0	12.15	12.15	11.81	11.48	10.80
	39.0	36.0	12.82	12.49	12.49	11.81	11.48
	44.0	40.0	13.16	13.16	12.82	12.15	11.48
	47.0	43.0	13.84	13.84	13.50	12.49	11.48
	51.0	47.0	14.18	13.84	13.50	12.49	11.48
	54.0	50.0	14.85	14.18	13.50	12.49	11.48
	57.0	53.0	15.19	14.18	13.50	12.49	11.48
60.0	56.0	15.52	14.51	13.50	12.49	11.48	
AM012JNGDCH/AA	-12.6	-13.0	7.02	7.56	7.22	7.22	7.76
	-7.1	-7.6	7.70	7.90	7.56	7.56	7.76
	-3.6	-4.0	8.15	8.12	7.79	7.79	7.76
	-1.8	-2.2	8.37	8.23	7.90	7.90	7.76
	2.0	1.0	8.83	8.49	8.15	8.15	7.81
	6.0	5.0	9.15	8.81	8.51	8.47	8.17
	10.0	9.0	9.38	9.04	8.98	8.71	8.64
	13.0	12.0	9.70	9.62	9.62	9.28	9.28
	17.0	15.0	9.90	9.90	9.84	9.56	9.51
	19.0	18.0	10.12	10.12	9.96	9.79	9.62
	23.0	21.0	10.46	10.46	10.12	10.12	9.79
	26.0	24.0	11.14	10.80	10.80	10.46	10.12
	30.0	28.0	11.48	11.48	11.14	10.80	10.46
	35.0	32.0	12.15	12.15	11.81	11.48	10.80
	39.0	36.0	12.82	12.49	12.49	11.81	11.48
	44.0	40.0	13.16	13.16	12.82	12.15	11.48
	47.0	43.0	13.84	13.84	13.50	12.49	11.48
	51.0	47.0	14.18	13.84	13.50	12.49	11.48
	54.0	50.0	14.85	14.18	13.50	12.49	11.48
	57.0	53.0	15.19	14.18	13.50	12.49	11.48
60.0	56.0	15.52	14.51	13.50	12.49	11.48	
AM018JNFDCH/AA	-12.6	-13.0	11.87	11.05	11.56	11.24	11.24
	-7.1	-7.6	12.19	11.68	11.87	11.56	11.56
	-3.6	-4.0	12.40	12.11	12.09	11.77	11.77
	-1.8	-2.2	12.51	12.32	12.19	11.87	11.87
	2.0	1.0	12.79	12.75	12.43	12.11	12.06
	6.0	5.0	13.40	13.08	12.76	12.48	12.16
	10.0	9.0	13.84	13.52	13.21	13.14	12.82
	13.0	12.0	14.44	14.37	14.05	13.81	13.73
	17.0	15.0	14.76	14.71	14.44	14.13	14.02
	19.0	18.0	15.08	14.92	14.76	14.44	14.13
	23.0	21.0	15.56	15.24	15.24	14.92	14.29
	26.0	24.0	16.51	16.19	15.87	15.56	14.92
	30.0	28.0	17.14	16.82	16.82	16.19	15.56
	35.0	32.0	18.09	17.78	17.46	16.82	15.87
	39.0	36.0	18.73	18.73	18.41	17.78	16.82
	44.0	40.0	19.68	19.36	19.05	18.09	16.82
	47.0	43.0	20.63	20.32	20.00	18.41	16.82
	51.0	47.0	21.27	20.63	20.00	18.41	16.82
	54.0	50.0	21.90	20.95	20.00	18.41	16.82
	57.0	53.0	22.54	21.27	20.00	18.41	16.82
60.0	56.0	23.17	21.59	20.00	18.41	16.82	
AM018JNGDCH/AA	-12.6	-13.0	11.87	11.05	11.56	11.24	11.24
	-7.1	-7.6	12.19	11.68	11.87	11.56	11.56
	-3.6	-4.0	12.40	12.11	12.09	11.77	11.77
	-1.8	-2.2	12.51	12.32	12.19	11.87	11.87
	2.0	1.0	12.79	12.75	12.43	12.11	12.06
	6.0	5.0	13.40	13.08	12.76	12.48	12.16
	10.0	9.0	13.84	13.52	13.21	13.14	12.82
	13.0	12.0	14.44	14.37	14.05	13.81	13.73
	17.0	15.0	14.76	14.71	14.44	14.13	14.02
	19.0	18.0	15.08	14.92	14.76	14.44	14.13
	23.0	21.0	15.56	15.24	15.24	14.92	14.29
	26.0	24.0	16.51	16.19	15.87	15.56	14.92
	30.0	28.0	17.14	16.82	16.82	16.19	15.56
	35.0	32.0	18.09	17.78	17.46	16.82	15.87
	39.0	36.0	18.73	18.73	18.41	17.78	16.82
	44.0	40.0	19.68	19.36	19.05	18.09	16.82
	47.0	43.0	20.63	20.32	20.00	18.41	16.82
	51.0	47.0	21.27	20.63	20.00	18.41	16.82
	54.0	50.0	21.90	20.95	20.00	18.41	16.82
	57.0	53.0	22.54	21.27	20.00	18.41	16.82
60.0	56.0	23.17	21.59	20.00	18.41	16.82	

Capacity table

Floor standing

Heating

TC : Total Capacity

Model	Outdoor temperature (°F)		Indoor temperature (°F, DB)				
			61.0	65.0	70.0	72.0	75.0
	DB	WB	TC	TC	TC	TC	TC
AM024JNFDCH/AA	-12.6	-13.0	15.46	16.00	15.66	15.32	15.32
	-7.1	-7.6	16.13	16.33	16.00	15.66	15.66
	-3.6	-4.0	16.58	16.56	16.22	15.88	15.88
	-1.8	-2.2	16.81	16.67	16.33	16.00	16.00
	2.0	1.0	17.31	16.98	16.64	16.25	16.20
	6.0	5.0	17.99	17.65	17.31	16.67	16.33
	10.0	9.0	18.70	18.36	18.02	17.62	17.28
	13.0	12.0	19.66	19.32	18.98	18.65	18.56
	17.0	15.0	20.08	19.74	19.41	19.07	19.01
	19.0	18.0	20.42	20.08	19.74	19.41	19.24
	23.0	21.0	20.92	20.59	20.25	19.91	19.58
	26.0	24.0	21.94	21.94	21.60	20.92	20.25
	30.0	28.0	23.29	22.95	22.61	21.60	20.92
	35.0	32.0	24.30	23.96	23.62	22.61	21.60
	39.0	36.0	25.65	25.31	24.64	23.96	22.95
	44.0	40.0	26.66	26.33	25.99	24.30	22.95
	47.0	43.0	27.67	27.34	27.00	24.98	22.95
	51.0	47.0	28.69	27.67	27.00	24.98	22.95
	54.0	50.0	29.36	28.35	27.00	24.98	22.95
	57.0	53.0	30.37	28.69	27.00	24.98	22.95
60.0	56.0	31.05	29.03	27.00	24.98	22.95	
AM024JNGDCH/AA	-12.6	-13.0	15.46	16.00	15.66	15.32	15.32
	-7.1	-7.6	16.13	16.33	16.00	15.66	15.66
	-3.6	-4.0	16.58	16.56	16.22	15.88	15.88
	-1.8	-2.2	16.81	16.67	16.33	16.00	16.00
	2.0	1.0	17.31	16.98	16.64	16.25	16.20
	6.0	5.0	17.99	17.65	17.31	16.67	16.33
	10.0	9.0	18.70	18.36	18.02	17.62	17.28
	13.0	12.0	19.66	19.32	18.98	18.65	18.56
	17.0	15.0	20.08	19.74	19.41	19.07	19.01
	19.0	18.0	20.42	20.08	19.74	19.41	19.24
	23.0	21.0	20.92	20.59	20.25	19.91	19.58
	26.0	24.0	21.94	21.94	21.60	20.92	20.25
	30.0	28.0	23.29	22.95	22.61	21.60	20.92
	35.0	32.0	24.30	23.96	23.62	22.61	21.60
	39.0	36.0	25.65	25.31	24.64	23.96	22.95
	44.0	40.0	26.66	26.33	25.99	24.30	22.95
	47.0	43.0	27.67	27.34	27.00	24.98	22.95
	51.0	47.0	28.69	27.67	27.00	24.98	22.95
	54.0	50.0	29.36	28.35	27.00	24.98	22.95
	57.0	53.0	30.37	28.69	27.00	24.98	22.95
60.0	56.0	31.05	29.03	27.00	24.98	22.95	

Dimensional drawing

Floor standing

AM006JNFDCH/AA, AM009JNFDCH/AA, AM012JNFDCH/AA

Units : mm / inches

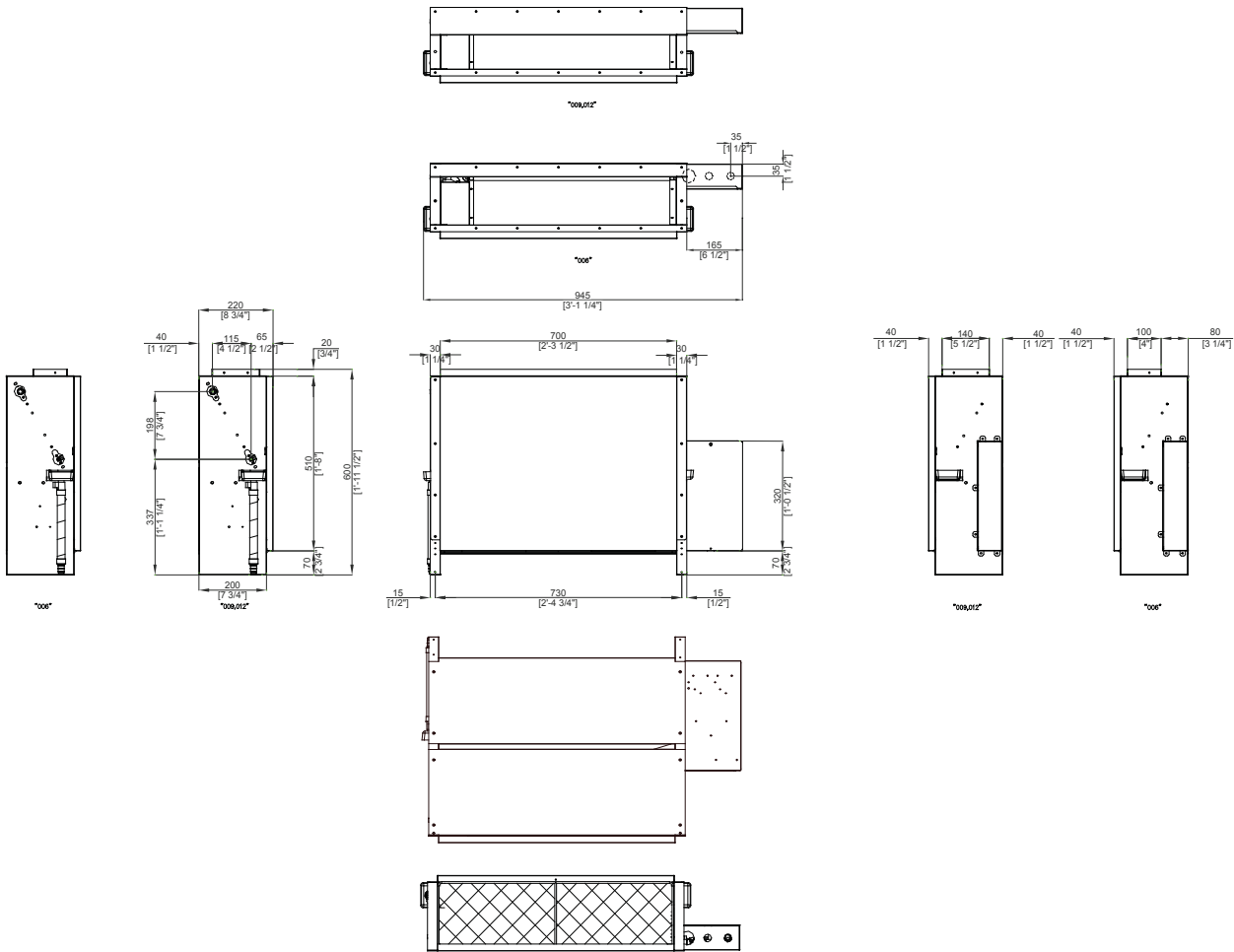

* Installation Guide

Unit: inch (mm)

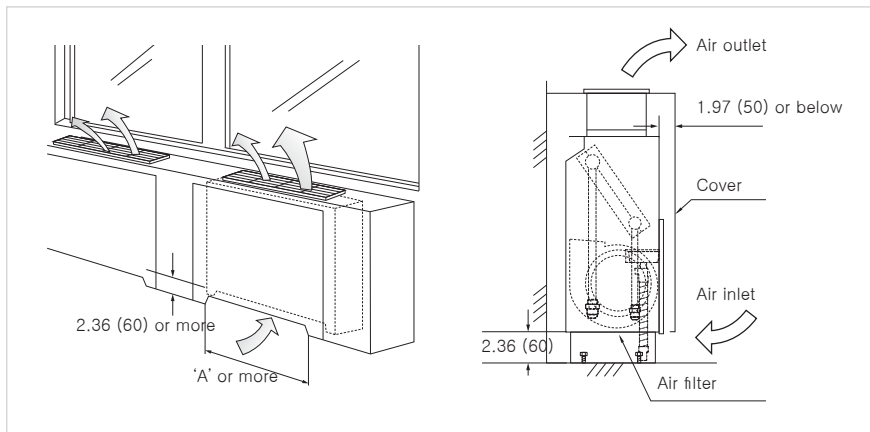

Dimensional drawing

Floor standing

AM006JNGDCH/AA, AM009JNGDCH/AA, AM012JNGDCH/AA

Units : mm / inches

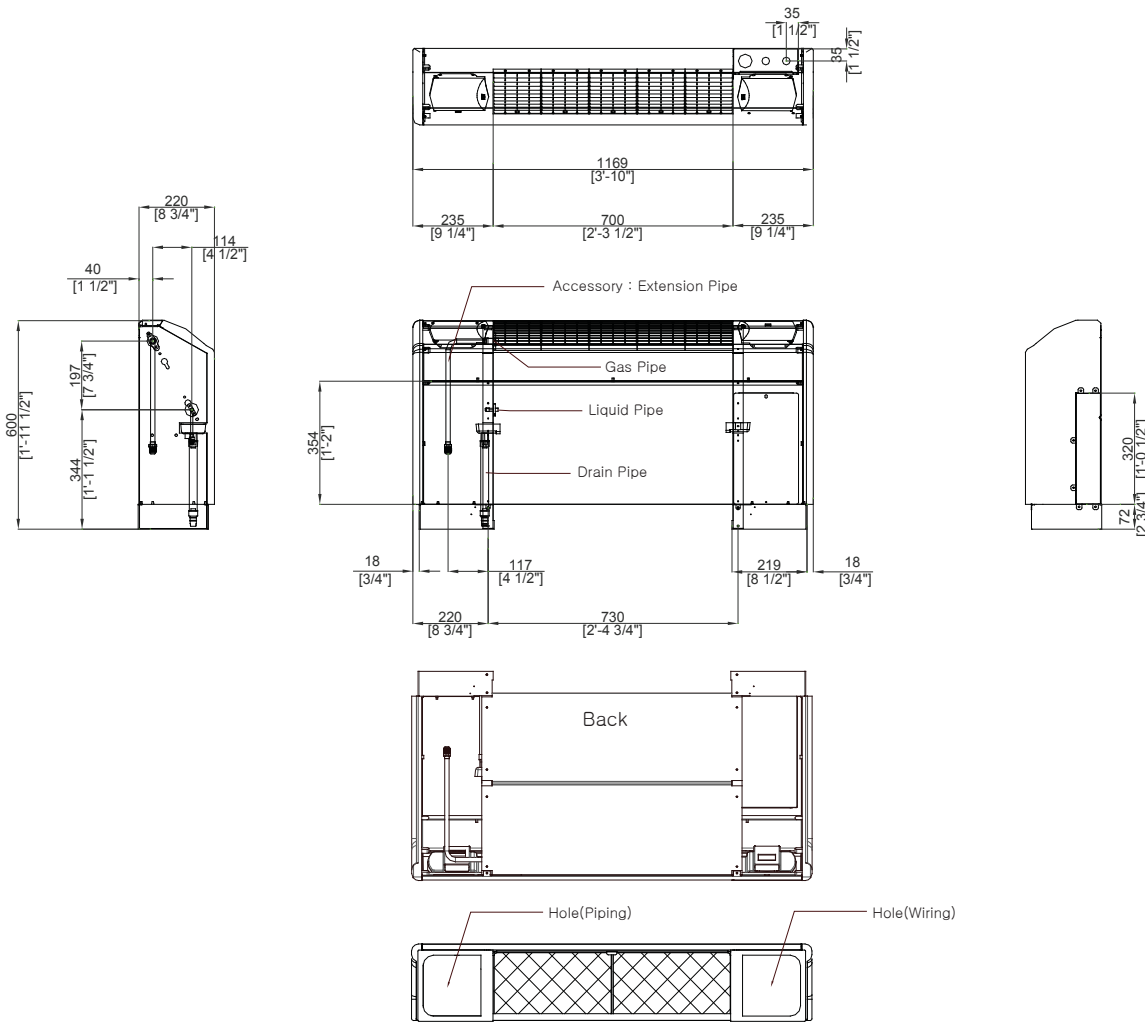

* Installation Guide

Unit: inch (mm)

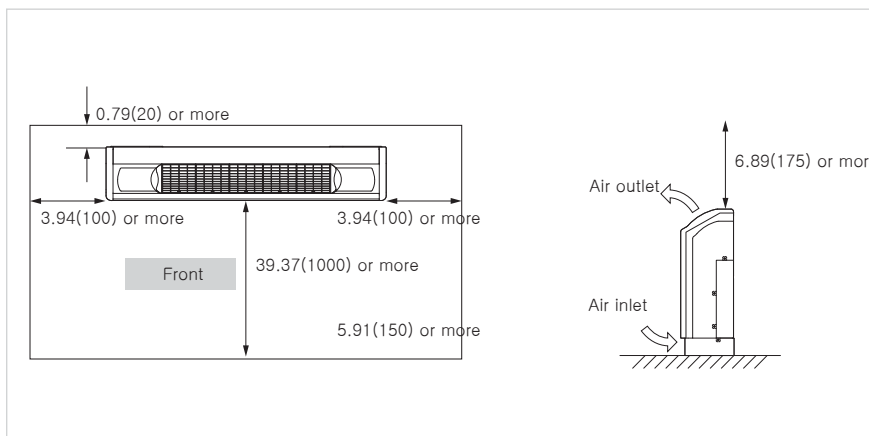

Dimensional drawing

Floor standing

AM018JNFDCH/AA, AM024JNFDCH/AA

Units : mm / inches

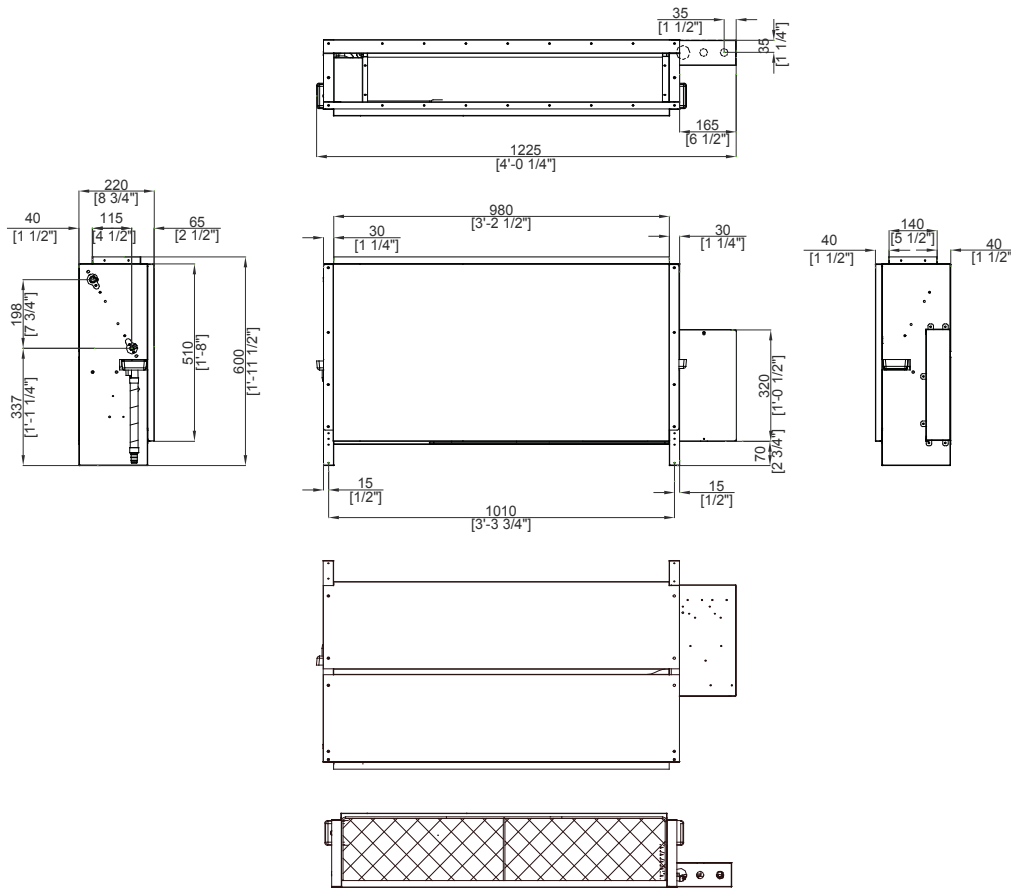

* Installation Guide

Unit: inch (mm)

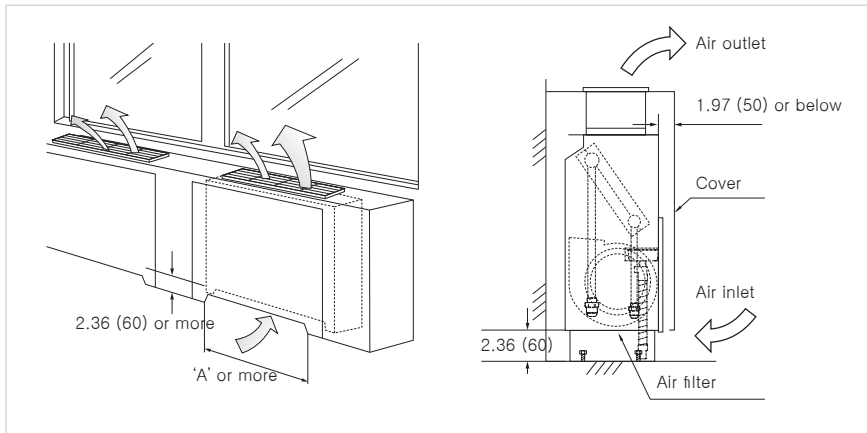

Dimensional drawing

Floor standing

AM018JNGDCH/AA, AM024JNGDCH/AA

Units : mm / inches

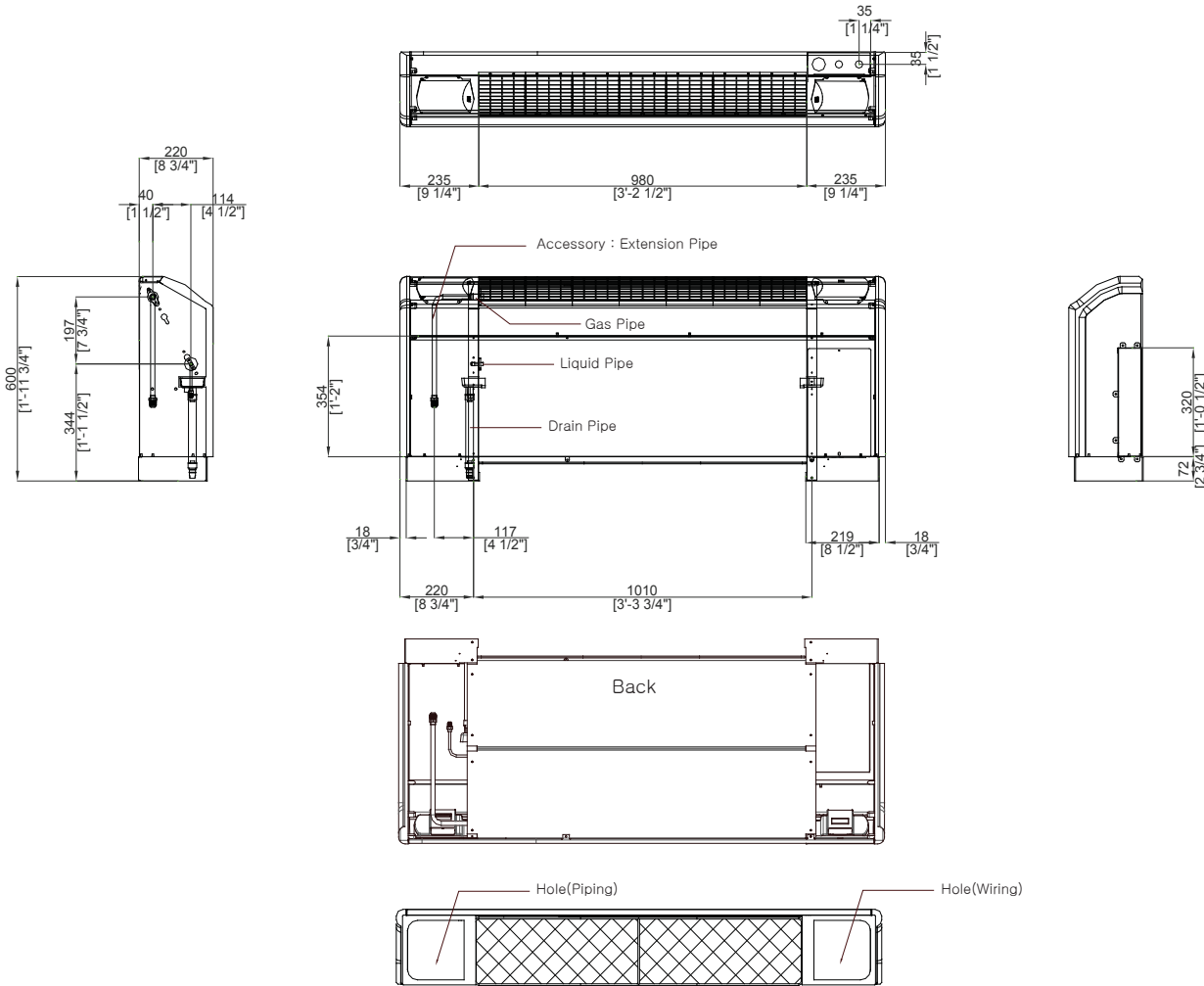

* Installation Guide

Unit: inch (mm)

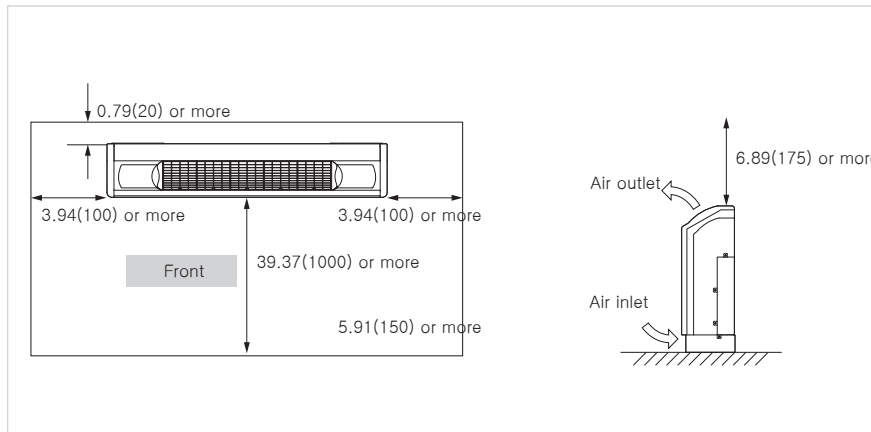

Electrical wiring diagram

Floor standing

AM006JNFDCH/AA, AM006JNGDCH/AA, AM009JNFDCH/AA, AM009JNGDCH/AA, AM012JNFDCH/AA, AM012JNGDCH/AA, AM018JNFDCH/AA
 AM018JNGDCH/AA, AM024JNFDCH/AA, AM024JNGDCH/AA

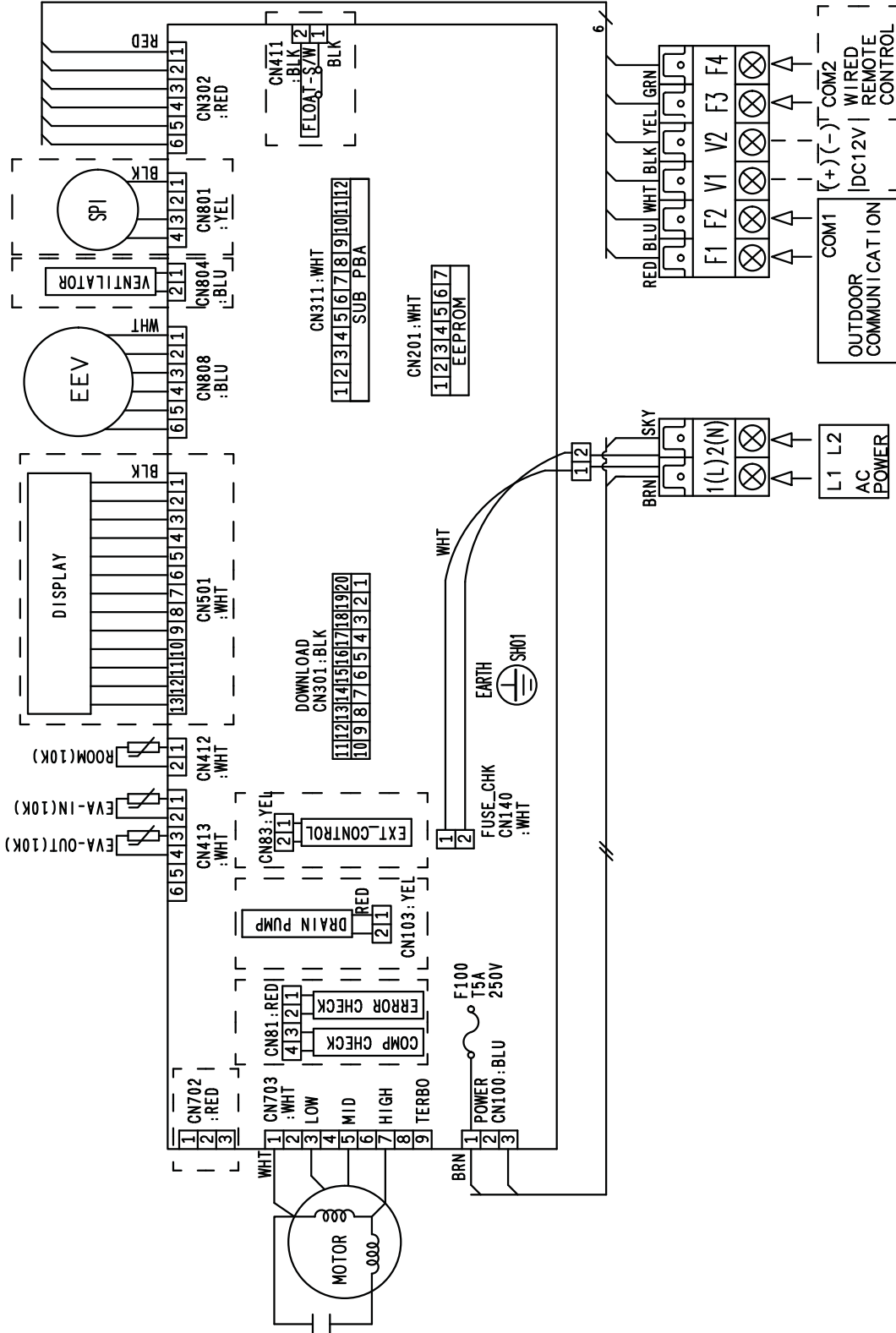

Sound pressure level

Floor standing

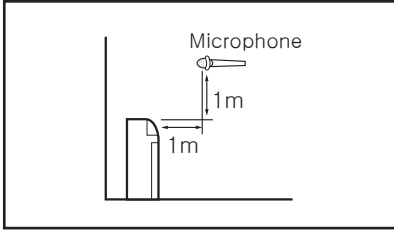

Unit: dB(A)

Model	High	Low
AM006JNFDCH/AA	23	20
AM006JNGDCH/AA	23	20
AM009JNFDCH/AA	26	21
AM009JNGDCH/AA	26	21

Note

- These operation values were obtained in an anechoic room. - Sound pressure level will vary depending on a factors such as the construction of the particular room where the equipment is installed.
- Operation sound level may differ depending on operation and ambient conditions.

NC curve

1) AM006JNFDCH/AA

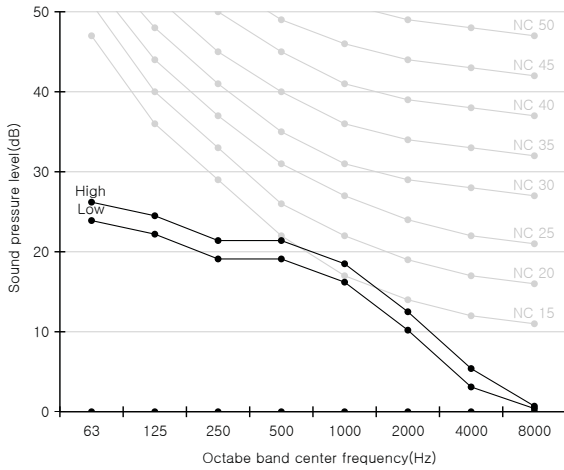

2) AM006JNGDCH/AA

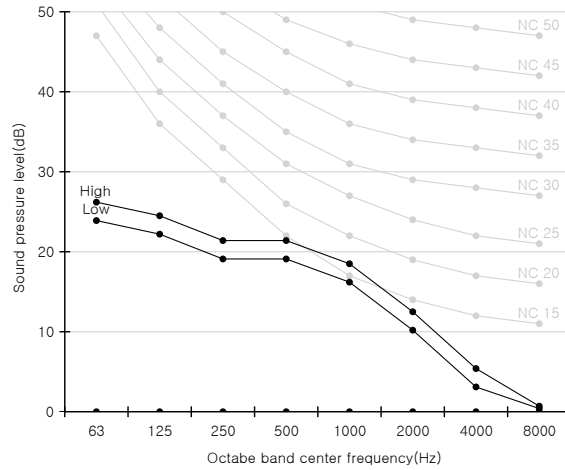

3) AM009JNFDCH/AA

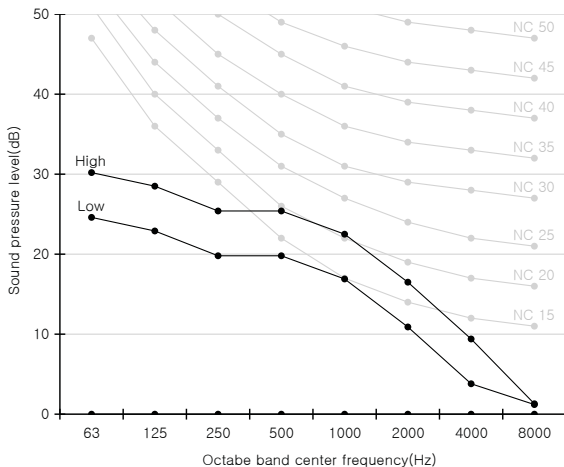

4) AM009JNGDCH/AA

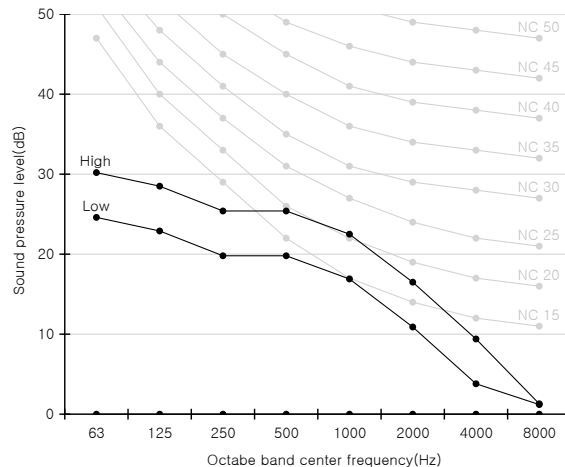

Sound pressure level

Floor standing

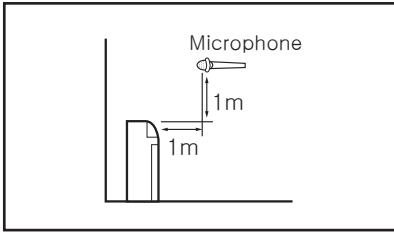

Unit: dB(A)

Model	High	Low
AM012JNFDCH/AA	37	27
AM012JNGDCH/AA	37	27
AM018JNFDCH/AA	40	32
AM018JNGDCH/AA	40	32

Note

- These operation values were obtained in an anechoic room. - Sound pressure level will vary depending on a factors such as the construction of the particular room where the equipment is installed.
- Operation sound level may differ depending on operation and ambient conditions.

NC curve

1) AM012JNFDCH/AA

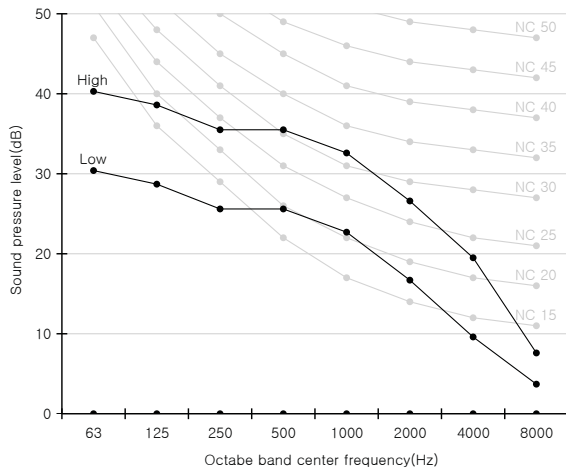

2) AM012JNGDCH/AA

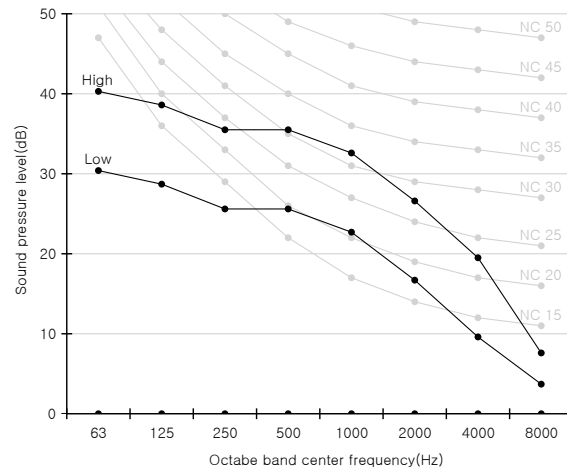

3) AM018JNFDCH/AA

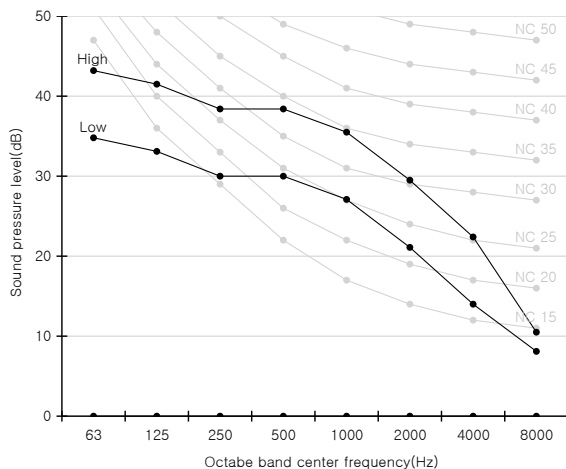

4) AM018JNGDCH/AA

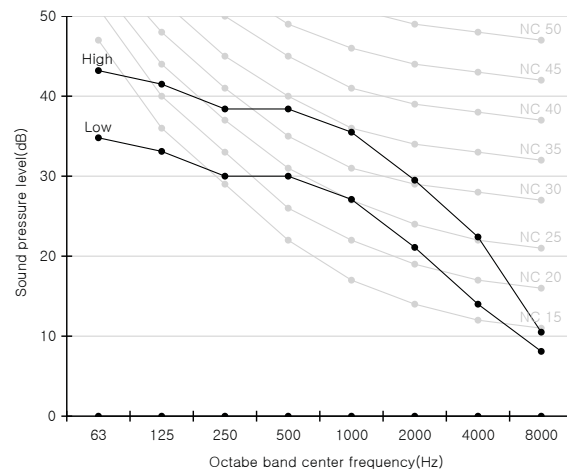

Sound pressure level

Floor standing

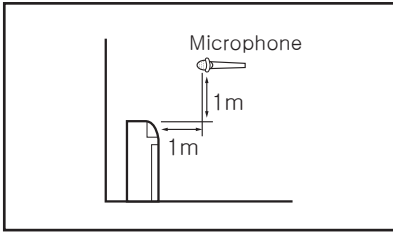

Unit: dB(A)

Model	High	Low
AM024JNFDCH/AA	40	32
AM024JNGDCH/AA	40	32

Note

- These operation values were obtained in an anechoic room. - Sound pressure level will vary depending on a factors such as the construction of the particular room where the equipment is installed.
- Operation sound level may differ depending on operation and ambient conditions.

NC curve

1) AM024JNFDCH/AA

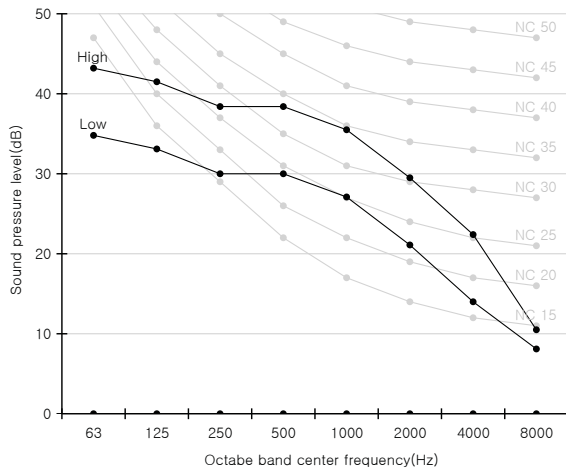

2) AM024JNGDCH/AA

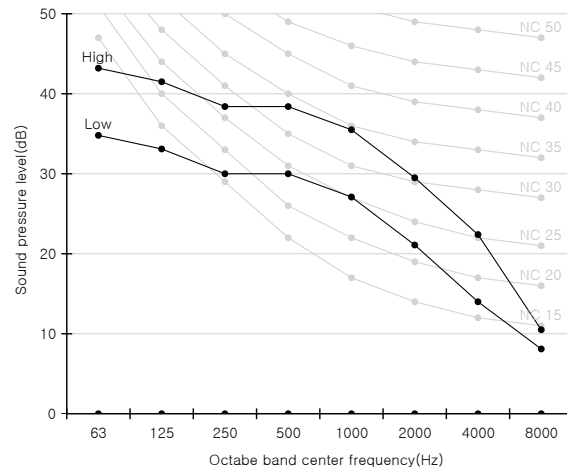

Floor standing

AM006JNGDCH/AA

(1) Cooling air velocity distribution

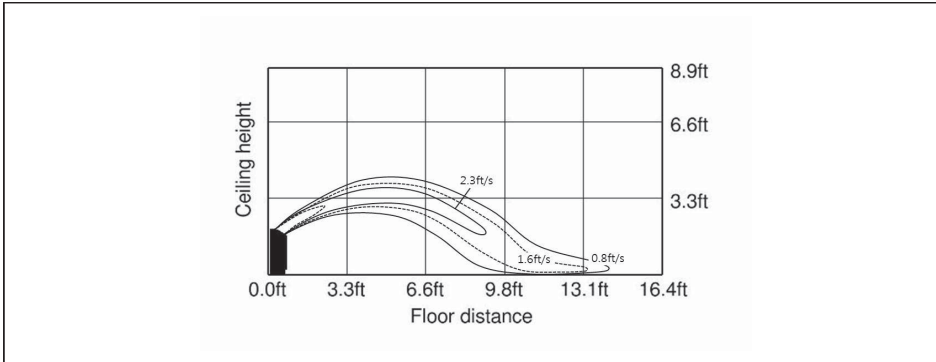

(2) Cooling temperature distribution

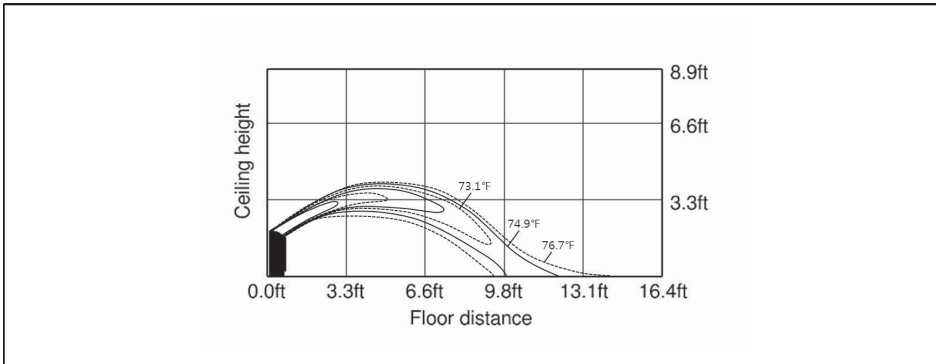

(3) Heating air velocity distribution

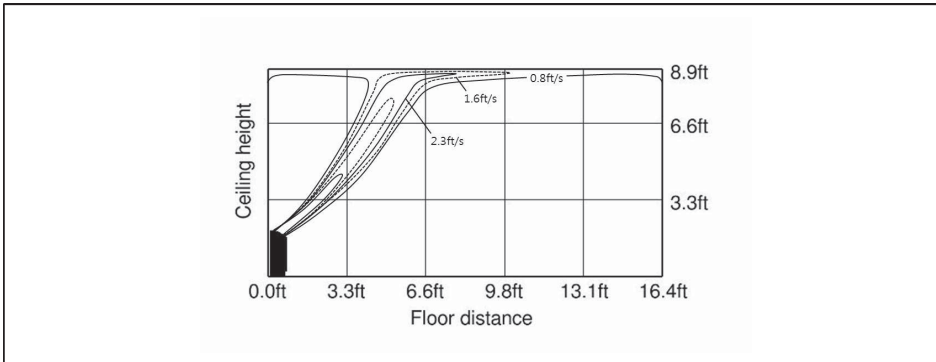

(4) Heating temperature distribution

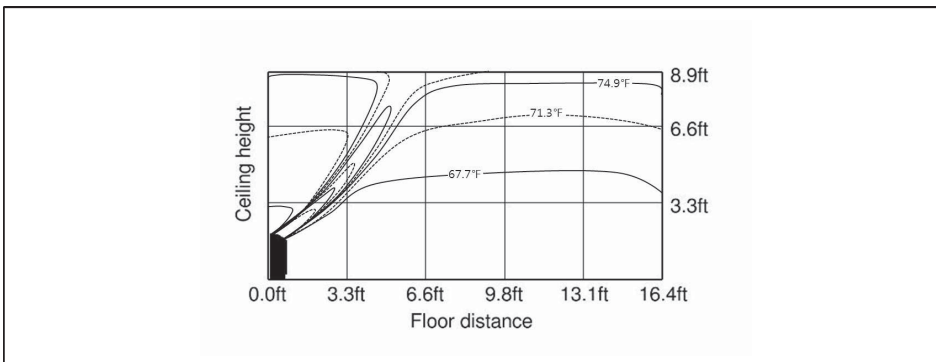

Floor standing

AM009JNGDCH/AA

(1) Cooling air velocity distribution

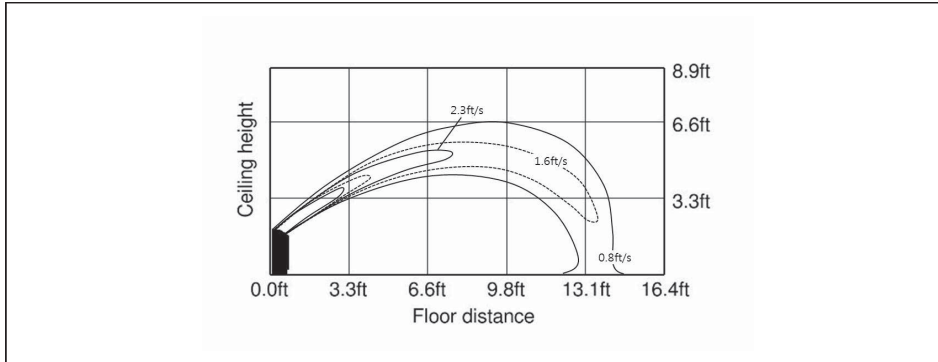

(2) Cooling temperature distribution



(3) Heating air velocity distribution

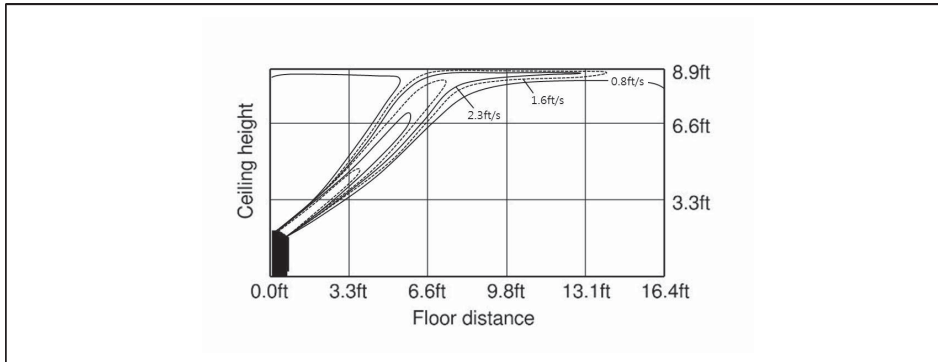

(4) Heating temperature distribution

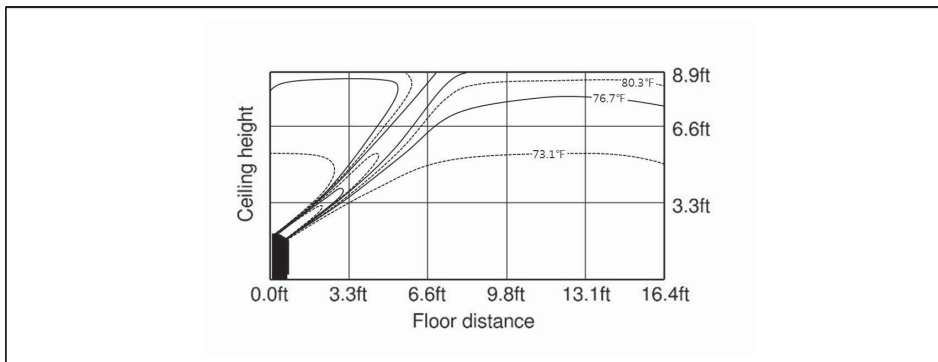

Floor standing

AM012JNGDCH/AA

(1) Cooling air velocity distribution

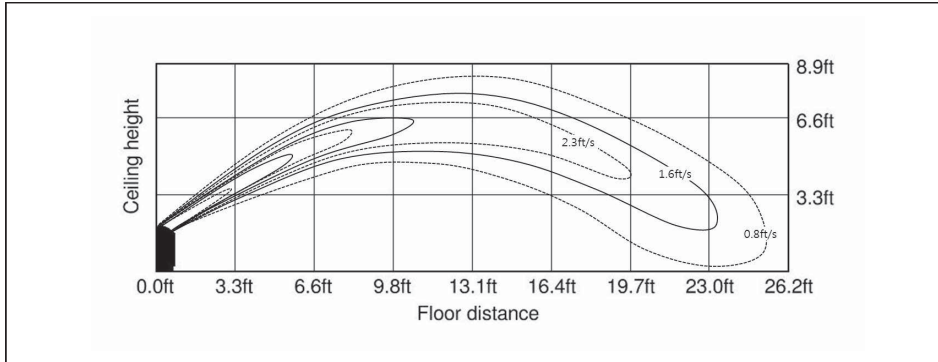

(2) Cooling temperature distribution

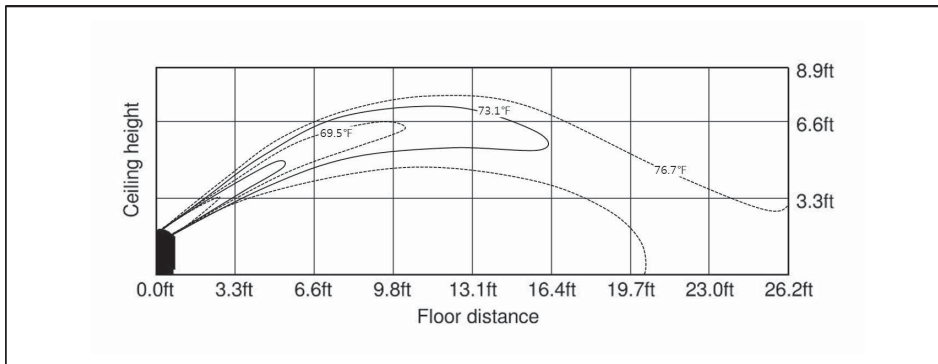

(3) Heating air velocity distribution

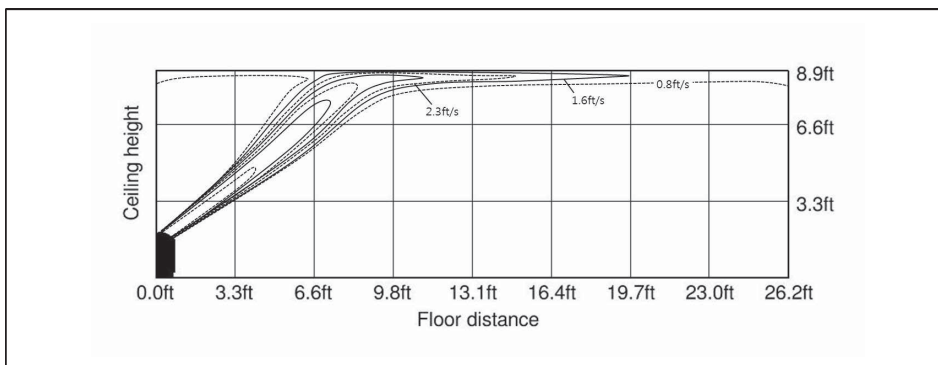

(4) Heating temperature distribution

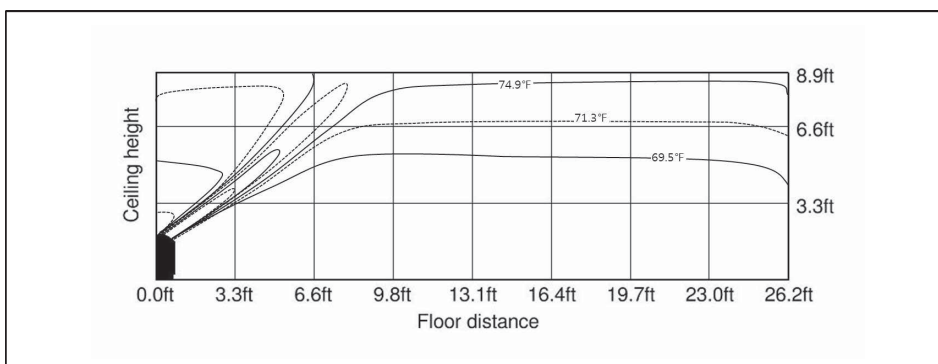

Floor standing

AM018JNGDCH/AA

(1) Cooling air velocity distribution

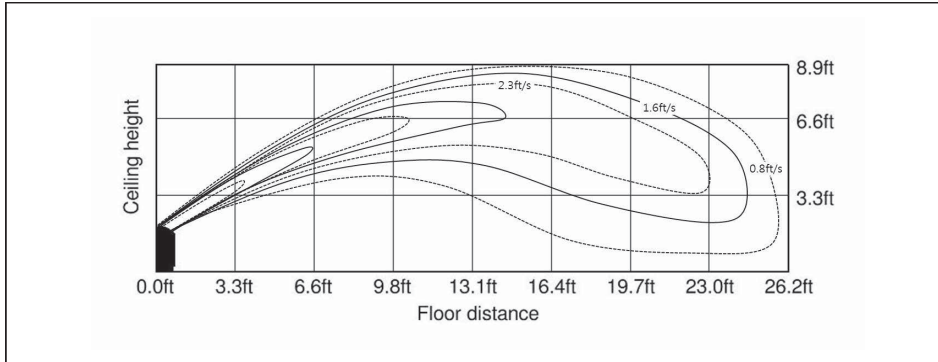

(2) Cooling temperature distribution

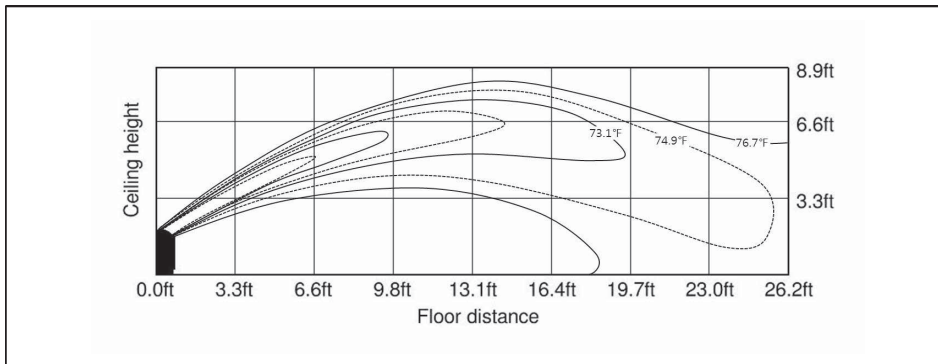

(3) Heating air velocity distribution

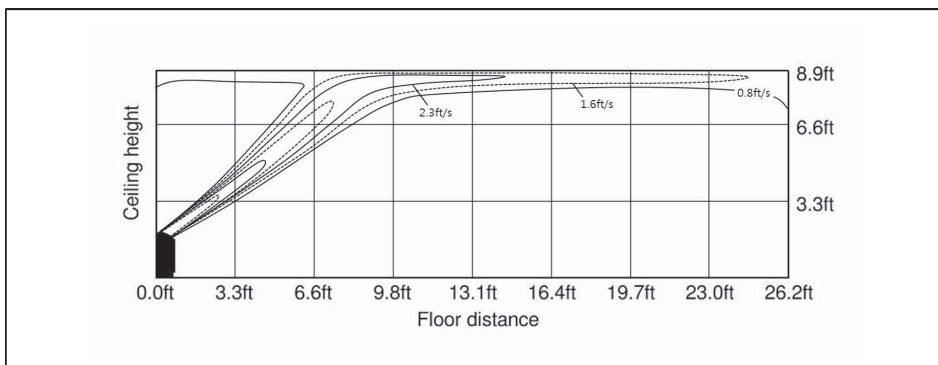

(4) Heating temperature distribution

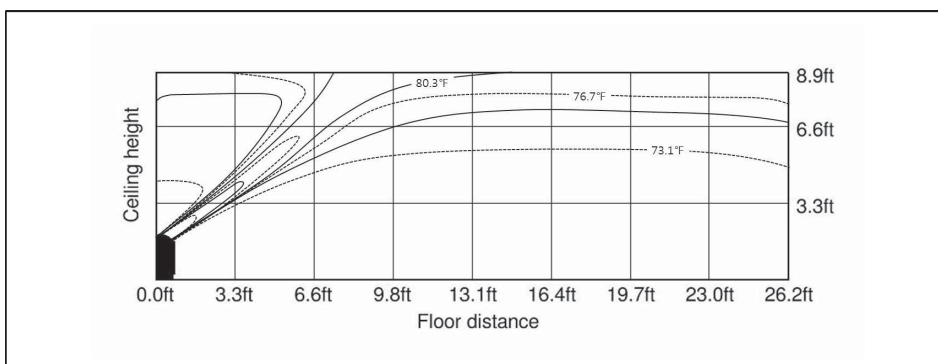

Temperature and air flow distribution

Floor standing

AM024JNGDCH/AA

(1) Cooling air velocity distribution

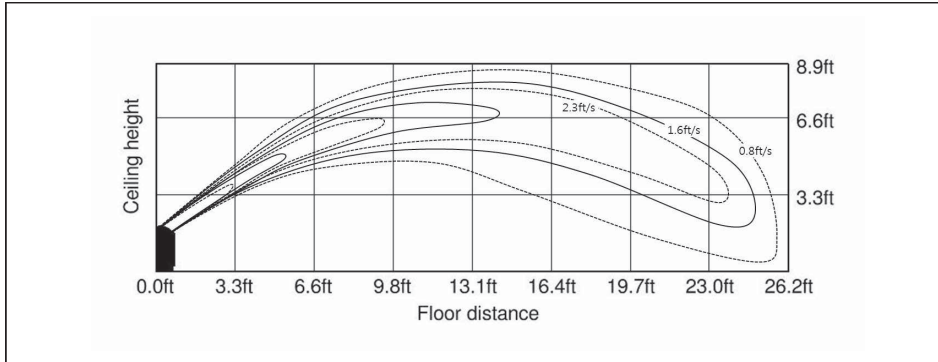

(2) Cooling temperature distribution

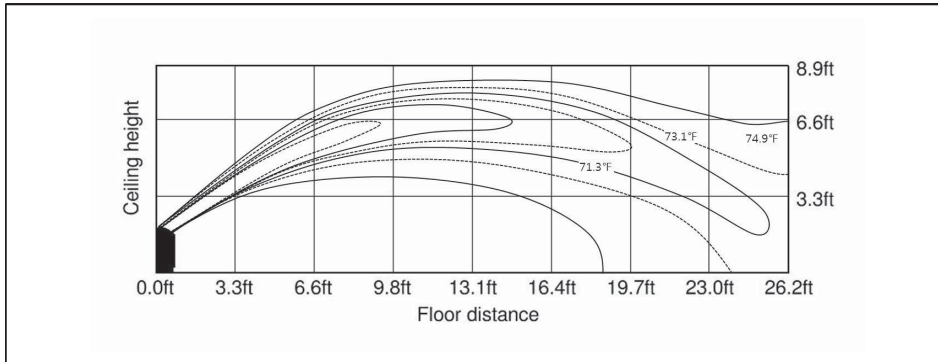

(3) Heating air velocity distribution

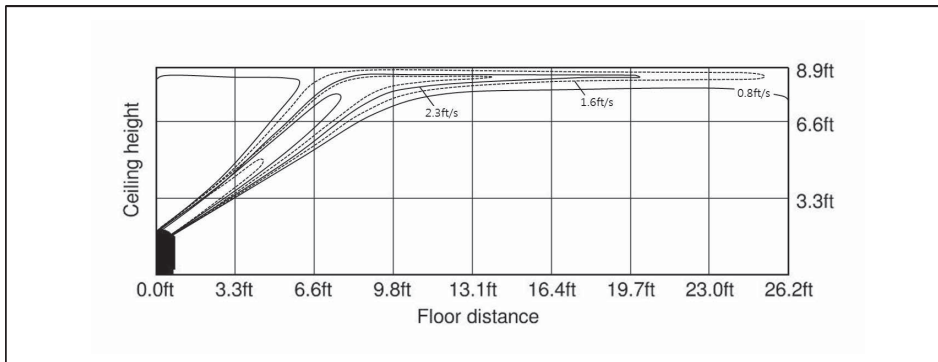

(4) Heating temperature distribution

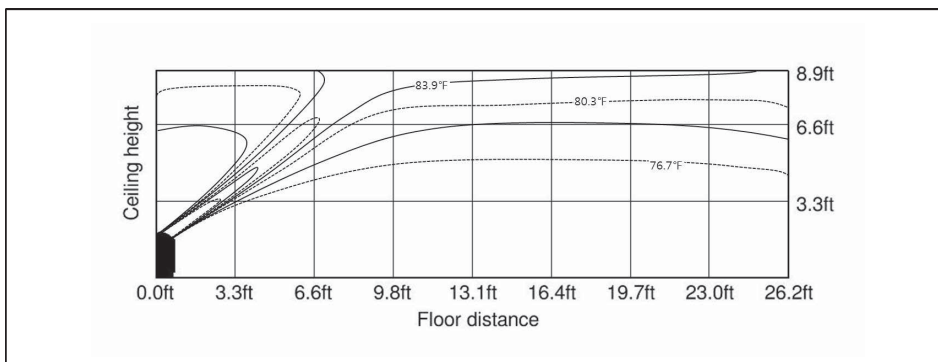

2016.12

The Samsung logo, consisting of the word "SAMSUNG" in a bold, sans-serif font, is enclosed within a white oval shape. The oval is positioned on the left side of a dark grey rounded rectangular box at the bottom of the page.

SAMSUNG

Samsung Electronics Co., LTD.

B2B PM / SE

Head Office (Suwon Korea) 129, Samsung-Ro, Yeongtong-Gu, Suwon City, Gyeonggi-Do, Korea 443-742

Website : www.samsung.com Email : airconditioner@samsung.com

Images and data in this book may subject to change without prior notice.