

PORTACOOOL HURRICANE OWNER'S MANUAL

PACHR370, PACHR360



PORTACOOOL™

WHEN COMFORT COUNTS™

QUICK SETUP

1



Remove box and pallet

2



Position cooler on level surface

3



Fill tank or attach water hose*

*Maximum water pressure 50 psi/345 kPa

4



120v for HR3600
and HR360

240v for HR370

Plug into appropriate outlet

5

For setup, Kuul® evaporative media should appear wet before starting the fan. Check the low water indicator on the control panel to monitor water level in tank. The water adjustment valve on each portable evaporative cooler is set at max flow. However, ensure the knob is turned completely to the right before use. Turn to the left to increase water flow. If entrainment occurs - water is spitting from the front of the product - use the valve to decrease the water flow until entrainment ceases.

Fill the tank, then turn on the pump switch and the fan

6

Your Portacool portable evaporative cooler is meant to be used in an open-air environment, such as a patio. If you plan to use your evaporative cooler in a more closed environment - such as a garage, sunroom or barn - you must provide adequate ambient airflow to ensure your evaporative cooler works at its highest efficiency. When using in a semi-closed environment, be sure to leave a door or window open to allow for the proper amount of airflow.

Ensure proper airflow is available

SAFETY

OPERATION WARNINGS

1. Not for use by children
2. Not for use by persons with reduced physical, sensory or mental capabilities
3. Not for use by persons who have not reviewed the owner's manual and familiarized themselves with the operation of the product

SAFE OPERATION

To reduce the risk of electric shock, fire or injury:

- Do not operate any evaporative cooler with a damaged cord or plug.
- Do not run power cord under carpeting or cover with throwrugs, runners or similar coverings. Arrange power cord away from traffic areas to avoid tripping hazards.
- Read the evaporative cooler's instructions, owner's manual and labels thoroughly before use.
- Always unplug the power cord to the evaporative cooler before performing inspections or repairs.
- Always unplug the evaporative cooler during filling and cleaning.
- Do not step on or roll over power cord with heavy or sharp objects.
- Do not operate evaporative cooler unless all KUUL® evaporative media is securely in place.
- Test the GFCI receptacle or breaker monthly to ensure it is functioning properly.
- Remove the plug from the electrical receptacle by pulling on the plug, not the power cord.
- Operation near open flames or sparks is not recommended.
- If operating near open flame or sparks, ensure the pump is continuously running in order to saturate and wet KUUL evaporative media.
- When cleaning your evaporative cooler, ensure water does not get into the motor or electrical system to prevent damage.
- The use of extension cords with your evaporative cooler is not recommended. However, if the owner determines that his or her circumstance or intended use requires the use of an extension cord, the following requirements must be met:
 - Use properly grounded 14 AWG or greater for PACHR3600 and PACHR360
 - Use properly grounded 12 AWG or greater for PACHR370
 - Extension cord must not exceed 50 feet (15.24 meters) in length; and
 - Extension cord must be properly grounded
- Evaporative coolers should not be modified in any way (other than repairs made by qualified individuals with Portacool replacement parts).
- If the evaporative cooler is damaged or malfunctions, do not continue to operate it. Refer to the warranty, troubleshooting or FAQ sections of this owner's manual, call Portacool, LLC Customer Service at (936) 598-5651 or (800) 695-2942, or email support@portacool.com.

OVERVIEW



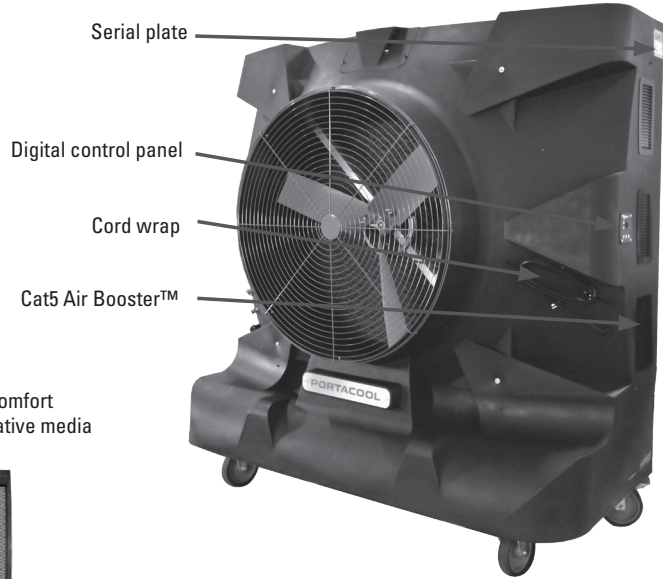
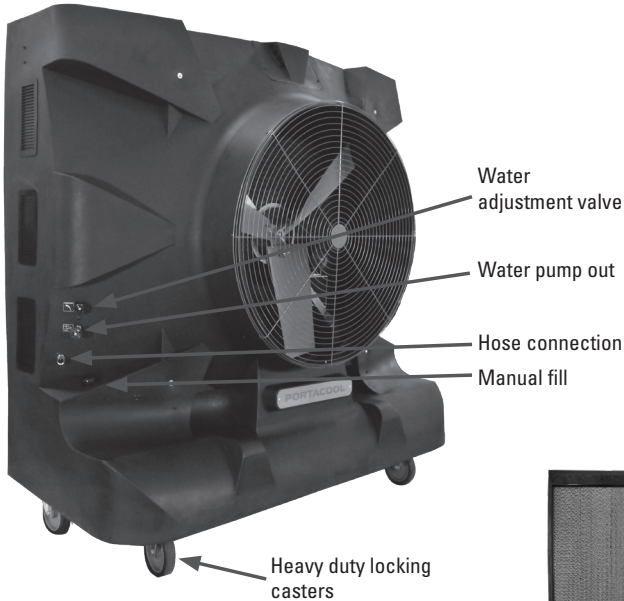

HURRICANE 370



Kuul® Comfort evaporative media



Two inch drain

WARNING: Consult Owner's Manual. Service by trained personnel recommended.				
 <p>Rotating fan blades Can cause serious injury or cut. Keep hands clear. Turn off product before servicing.</p>	 <p>Hazardous voltage inside Disconnect power before servicing. GFCI device required.</p>	 <p>Some components flammable Keep flames and heat away.</p>	 <p>Do not run pump without water in product Can cause damage to components.</p>	<small>© 2014</small>

OVERVIEW



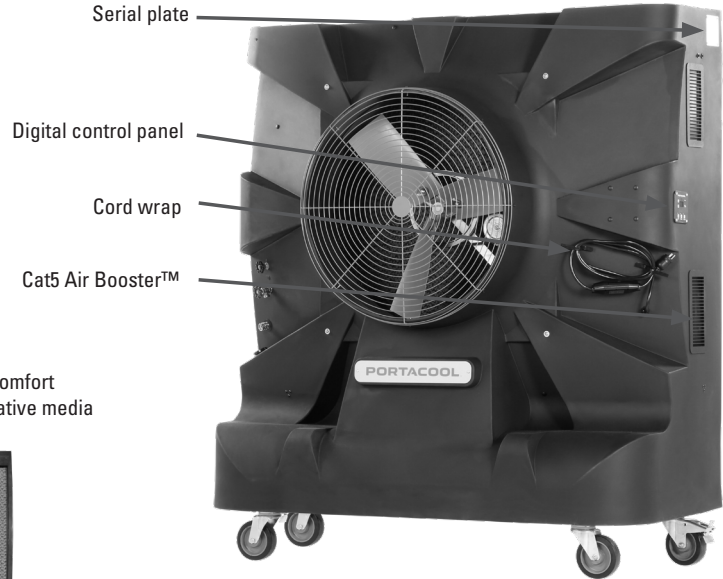
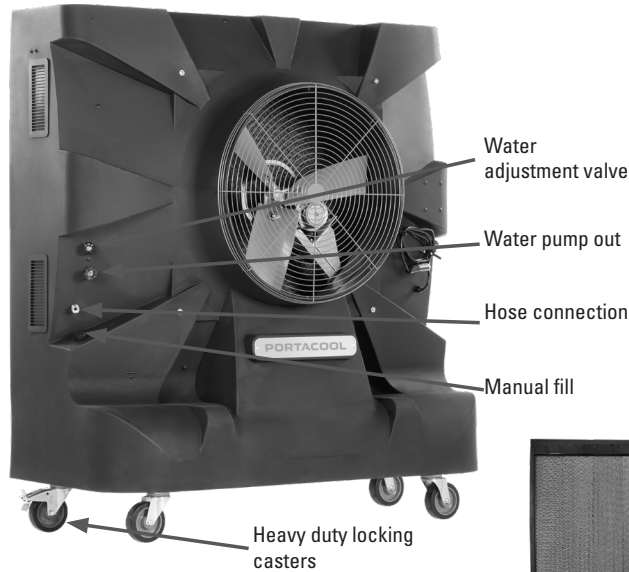

HURRICANE 360

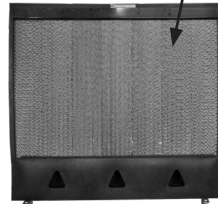

Kuul® Comfort evaporative media



WARNING: Consult Owner's Manual. Service by trained personnel recommended.

 <p>Rotating fan blades Can cause serious injury or cut. Keep hands clear. Turn off product before servicing.</p>	 <p>Hazardous voltage inside Disconnect power before servicing. GFCI device required.</p>	 <p>Some components flammable Keep flames and heat away.</p>	 <p>Do not run pump without water in product Can cause damage to components.</p>
--	--	---	---

GFCI/ELCI

The Portacool Hurricane™ series utilizes a ELCI (Equipment Leakage Circuit Interrupter) to help protect users against ground electrical faults, which prevent some fire and electrical shock hazards. These devices are intended to trip at very low leakage currents.

- Portacool Hurricane model PACHR360 uses an ELCI, which is built into the power cord and requires a 5-20R (120V) electrical outlet

The ELCI on model PACHR360 will not automatically reset when the evaporative cooler is plugged into an electrical outlet; the “reset” button located on the ELCI device must be pressed each time the evaporative cooler is plugged in.

If the ELCI is tripped and a simple “reset” will not work, please contact the Portacool Customer Service at (936) 598-5651 or (800) 695-2942 for more troubleshooting information.

START UP

PLACEMENT

- 1) Make sure there is a clear, unobstructed path in front of the evaporative cooler to provide maximum airflow.
- 2) If the evaporative cooler is positioned on a raised platform, ensure the platform is stable, well constructed, and will not allow the evaporative cooler to tip over and that it allows for the full weight of the evaporative cooler including a tank full of water. The cooler must be level and in the upright position. The casters should also be locked to prevent the evaporative cooler from moving.
- 3) If placed near a wall or other obstruction, position the evaporative cooler a minimum of 3 feet (0.9 meters) from the wall or obstruction with evaporative media facing the wall. This allows the unrestricted flow of warm air to the KUUL Comfort™ evaporative media side of the evaporative cooler. When using multiple evaporative coolers in close proximity, be sure to aim each evaporative cooler so the air flows complement each other to achieve maximum cooling capacity.

STARTING THE PUMP AND ADJUSTING THE WATER FLOW

Once the tank is full of water, moving the pump switch to the "ON" position on the control panel will turn on the pump. When initially turning on the pump, the level in the water tank will drop suddenly and restart the flow of supply water. This is a normal condition, as the evaporative media requires a large amount of water for proper wetting.

New Kuul Comfort™ evaporative media will require an initial 'breaking-in' period. This period is required for the media to begin readily absorbing water. It may require up to a week to achieve maximum efficiency.

It is important to ensure that the water flow to the evaporative media is properly adjusted when first starting the water flow in the evaporative cooler. Increasing the flow using the water adjustment valve makes this adjustment. Proper water adjustment should leave the evaporative media saturated with water, but not flooded. Evaporative media should appear wet.

When turning the evaporative cooler off at the end of the day or week, the pump should be turned off about 15 minutes before the fan to allow the Kuul evaporative media to dry.

STARTING THE PORTACOOOL EVAPORATIVE COOLER

Start the fan by turning the fan switch to the desired speed on the control panel. Before starting, make sure casters are in locked position.

DIGITAL CONTROLS

The user interface includes touch sensitive buttons for operation of the Portacool Hurricane™ 370. The user interface also includes status indicator LEDs and a 7-segment display to show the status of the evaporative cooler.

- 1** Power
The green Power LED is illuminated when the evaporative cooler is plugged in.
- 2** Water level
The red water level LED is illuminated when the float switch detects a low water level and the pump is not turning on. This LED flashes if the pump is running during a low water occurrence to indicate that more water needs to be added in order to continue running the pump.
- 3** Timer
The controller features five pre-programmed modes which control the fan / pump sequence for a pre-defined period. Each touch of the program button cycles through the five modes: 1HR, 2HR, 4HR, 8HR, and TIMER OFF. During the program run, the user can adjust the maximum fan speed with the up/down buttons. When the program is active, the Timer LED will be on and, for five seconds, the user will be shown which program (1H, 2H, 4H, or 8H) is active.
- 4** Pump
Press the pump button once to power on and again to power off. The green Pump LED is illuminated when the pump is enabled. The LED flashes slowly if continuously held and the timer is disabled.
- 5** Fan
When the fan is off, touch the fan button once to turn the fan on in full speed. When the fan is on, touch of the Fan button again to turn the fan off. The green Fan LED is illuminated when the fan is active. The LED flashes slowly if continuously held and the timer is disabled.
- 6** Speeds
The buttons control the air velocity of the cooler. Beginning with "Lo", or 30% air flow, then 50%, then up to "Hi" or 100% airflow and increasing in five percent increments.
- 7** Two digits display the cooler's temperature, fan speed, and timer program. If the cooler does not have a temperature sensor connected, the display will constantly show fan speed. If the cooler does feature a temperature sensor, then the temperature is displayed unless: a fan speed change is being called upon either by means of the up/down button or by the timer's program. When a fan speed change is requested, the fan speed will be displayed for five seconds before returning to the cooler temperature.

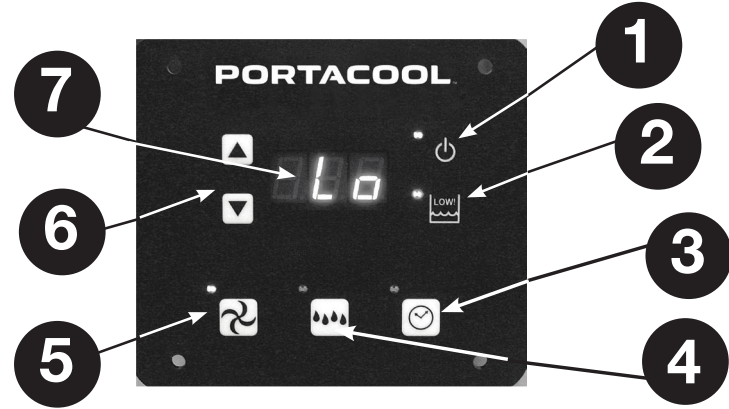

LOCK OUT FEATURE

If the operator would like to lock settings so that they can't be adjusted, simply press the "up" arrow and the fan button simultaneously to lock the controls. To unlock, press the "down" button and the fan icon. When enabled, "L-E", or "Lock Enabled", will be displayed in the LED.

FAHRENHEIT VS CELSIUS

If the operator would like to change the temperature setting from Fahrenheit to Celsius, press the fan, motor and timer buttons simultaneously. To switch from Celsius to Fahrenheit, simply repeat the process.

MAINTENANCE

While the rugged, corrosion-resistant construction ensures low maintenance will be required, keeping your evaporative cooler clean will ensure it stays in peak operating condition.

DAILY MAINTENANCE

The pump should be turned off approximately 15 minutes before the fan is turned off, which allows the Kuul® evaporative media to dry. Ensuring your Kuul evaporative media is dry at the end of the day not only extends its life, it also helps control the growth of mildew, mold, bacteria and other odor-causing elements.

WEEKLY MAINTENANCE

Your Portacool portable evaporative cooler should be shut down, disconnected from power and the tank should be drained once a week by removing the drain cap. Once the tank is drained and the power disconnected, the Kuul evaporative media may be removed to allow cleaning of the tank, where dust may collect over time. Replace Kuul evaporative media in correct airflow direction, referring to the label on the Kuul evaporative media.

If conditions, such as hard water, warrant, Portacool Hard Water Treatment™ can be purchased at www.portacoolparts.com or from authorized distributors. Portacool Hard Water Treatment keeps minerals present in your water in solution and off of your Kuul evaporative media by changing the ionic structure of the particles. It can increase cooling efficiency, remove and inhibit scale building up, reduce equipment corrosion, and extend evaporative media life.

STORAGE

1. Drain all water from the tank and wipe the tank clean, ensuring the Kuul evaporative media and tank are dry.
2. Roll up the power cord and secure it to ensure it will not be rolled over, tripped over or caught in equipment.
3. Cover the evaporative cooler completely to prevent dust build-up and store in a dry area. This also helps to prevent damage to the Kuul evaporative media. Optional protective covers are available from your distributor or at www.portacoolparts.com.

**ORDER PARTS
ONLINE**
portacoolparts.com

TROUBLESHOOT

Turn off all power to the evaporative cooler before attempting to troubleshoot any of the following symptoms. For problems not listed, please contact Customer Service.

SYMPTOM

POSSIBLE CAUSES

REMEDY

Evaporative cooler fails to start or deliver air

1. No electricity to the evaporative cooler
 - A. Circuit breaker tripped
 - B. ELCI tripped
 - C. Power unplugged or damaged
2. Motor overheated and/or frozen

1. Check power
 - A. Reset breaker*
 - B. Reset ELCI**
 - C. Plug in cord(s) or replace if damaged
2. Replace motor

Evaporative cooler starts, but air delivery is inadequate

1. Kuul evaporative media side of the evaporative cooler is too close to a wall
2. Fan motor failure
3. Capacitor failure

1. Move evaporative cooler at least three feet from the wall
2. Replace fan motor
3. Replace capacitor

Water draining from the evaporative cooler

1. Seat in float valve leaking
2. Drain plug not tight

1. Replace float valve
2. Tighten plug

Knocking, shaking, or rattling sounds

1. Loose parts
2. Fan blade rubbing shroud

1. Check and tighten where needed
2. Inspect and adjust, or replace fan blade

* If condition persists, call electrician

** See GFCI/ELCI section

TROUBLESHOOT

SYMPTOM

POSSIBLE CAUSES

REMEDY

Musty or unpleasant odor

1. Stale or stagnant water in tank
2. Kuul evaporative media is mildewed or clogged

1. Drain, flush and clean tank
2. Replace Kuul evaporative media

Water droplets in the air stream

1. Too much water delivered to Kuul evaporative media
2. Leaking hose

1. Make sure Kuul evaporative media is properly positioned in the frames and evaporative cooler is level
2. Tighten connection or replace hose

ORDER PARTS
ONLINE
portacoolparts.com

WARRANTY

TECHNICAL SUPPORT

Technical support and service is available directly from your distributor or call Portacool, LLC Customer Service at (800) 695-2942 for the distributor nearest you. You may also contact Customer Service for consultation on troubleshooting and parts replacement.

Please have serial number and model number of evaporative cooler available.

WARRANTY AND REPLACEMENT PARTS

PORTACOOl™ EVAPORATIVE COOLER LIMITED WARRANTY

For five (5) years from date of purchase, Portacool, LLC (hereafter "Portacool") warrants any original component part or parts of its Portacool™ portable evaporative coolers (the "Equipment") that are found, upon examination by factory-authorized personnel, to be defective in material or workmanship.

Notwithstanding anything herein to the contrary, Portacool warrants its Hurricane 370 and 360 housings for the full lifetime of the product to the extent they are found, upon examination by factory-authorized personnel, to be defective in material or workmanship. The Lifetime Warranty on product housings is void if the housing is found upon examination by Portacool to have been misused, abused or otherwise tampered with by unqualified personnel. The Lifetime Warranty on product housings does not cover ordinary wear and tear and is non-transferrable.

If the Equipment and/or its original component parts, develop a defect covered by this limited warranty within the applicable time periods described above, the same may be repaired by the customer after receiving the appropriate parts from Portacool or entirely replaced with a new product of the same by Portacool at the option of Portacool.

All transportation charges for shipment of the Equipment and/or its component parts that are submitted for replacement or repair under this warranty must be borne by the purchaser.

This warranty is void if: i) the Equipment and/or its component parts are found to have been misused, abused, repaired by or tampered with by unqualified personnel; ii) any of the product's component parts have been replaced with parts that were not authorized Portacool replacement parts; iii) the product has been modified in any way (other than repairs made by qualified individuals with Portacool replacement parts); iv) the product has not been appropriately registered by its original purchaser; or v) the customer cannot show proof of purchase as the product's original owner.

PORTACOOl LIMITATION OF LIABILITY

IN THE CASE OF A BREACH OF ANY IMPLIED OR WRITTEN WARRANTY RELATING TO THE EQUIPMENT AND/OR ITS COMPONENT PARTS, PORTACOOl SHALL NOT BE LIABLE FOR ANY INCIDENTAL OR CONSEQUENTIAL DAMAGES, AND THE LIMITS OF LIABILITY AGAINST PORTACOOl FOR ANY SUCH BREACH SHALL NOT EXCEED THE COST OF REPLACEMENT OR REPAIR OF THE EQUIPMENT.

PORTACOOOL PROTECT

Portacool, LLC is proud to provide world-class service and support. Portacool Protect™ brings together our commitment to service and support in the form of best-in-class warranties, service programs, technical support and live customer service to provide our customers with an ownership experience that is second to none.

Each of the following components are included with your Portacool Hurricane™ series product:

5

Year warranty
on Hurricane series
motor and electrical
components



Lifetime warranty
on all molded
 housings



Live, U.S.-based
Customer
Service

For complete warranty information and limitations, please see [Warranty page](#). Beyond these aspects of Portacool Protect™, we ask that you not hesitate to contact us with any additional questions or comments you might have. For more than 25 years, we have built our business on service and support. We look forward to speaking with you.

FAQ

Q. What assembly is required?

A. None. Portacool Hurricane evaporative coolers are ready to use right out of the box.

Q. How do I prepare my evaporative cooler for storage?

A. Drain the evaporative cooler, dry out the evaporative media, cover the evaporative cooler and store in a dry place.

Q. I just ran my evaporative cooler for the first time and there is an unpleasant odor.

A. Our unique design and manufacturing technique, together with our superior materials, enable our products to perform efficiently within a wide range of conditions. When installed correctly, our evaporative media products allow complete molecular evaporation of water ensuring a pure, clean stream of air. When new, it is possible that a small amount of aromatic molecules may evaporate along with the water molecules, which could be detected as a slight smell. This scent lessens in time. Our product does not, in any way, allow harmful chemicals to be evaporated into the air stream.

Q. My evaporative cooler is not putting out any cool air.

A. First, make sure the water source and electricity source are connected and working. Second, check to see if the Kuul evaporative media is damp. If not, adjust the water flow with the water adjustment valve. Third, make sure there is water in the tank. It should be allowed to fill before you turn the pump on.

Q. What is the best environment to produce the most cool air?

A. For optimum performance, the temperature should be 85° F or higher and the relative humidity should be below 75%. However, Portacool evaporative coolers will reduce the temperature in almost any environment, making it more comfortable.

Q. How often should my Kuul Comfort™ evaporative media be replaced?

A. Depending on the quality of maintenance and frequency of use, Kuul Comfort evaporative media typically last up to five years. However, should you have any questions about the life of the media in your Portacool® portable evaporative cooler, please call our Customer Service department for more detailed information.

Q. What is the difference between evaporative cooling and misting systems?

A. Misting systems spray a shower of water into the air that will collect on people, objects, equipment, floors, etc. Portacool evaporative coolers use the process of evaporation to produce cooler air, but do not produce a mist.

Q. Where can I buy replacement parts?

A. Replacement parts may be purchased online at www.portacoolparts.com or from any Portacool distributor. You may also contact Portacool Customer Service department for additional assistance.

Q. What is the amount of moisture produced?

A. An increase in humidity of approximately two to five percent is produced, depending on the temperature and humidity of the environment. This increase is not noticeable in a ventilated area where the air produced by the cooler is exhausted.

Q. How long will the water supply last in the tank?

A. With no direct water source available, the water will evaporate in a filled tank within two to 10 hours of operation, depending on the water capacity of the evaporative cooler, ambient conditions, temperature and humidity. A water source for refilling the tank is recommended by the manufacturer.

FAQ

Q. Where are the model and serial numbers found?

A. The model number can be found on a metal plate on the outside of the evaporative cooler. Model numbers begin with the letters "PAC." Serial numbers are all digits.

Q. What if my questions are not answered here?

A. Check out our videos on www.portacool.com or our YouTube channel. Our U.S.-based Customer Service staff is available 8 a.m. to 5 p.m. Central Time, Monday through Friday at (800) 695-2942 or you can e-mail them at support@portacool.com.

HOW TO REPLACE YOUR KUUL COMFORT™ EVAPORATIVE MEDIA

Step 1

Be sure to unplug your Portacool portable evaporative cooler before doing any maintenance. Lock the casters to keep your evaporative cooler from moving while you are working. Remove the flap and Kuul Comfort™ evaporative media from the evaporative cooler. The flap is attached at the top of the evaporative cooler with screws. Remove the screws and set the flap aside.

Step 2

All Kuul Comfort evaporative media must be removed before accessing the inside of the evaporative cooler. Remove the center set of Kuul Comfort evaporative media first by grasping at the top and tilting it out and away from the evaporative cooler. While tilting the Kuul Comfort evaporative media out, lift it up and out of the evaporative cooler.

Step 3

Remove remaining Kuul Comfort evaporative media in the same manner. Set aside in a safe place to prevent damage while out of the evaporative cooler. Once all the Kuul Comfort evaporative media has been removed, you should have access to the inside of the evaporative cooler and internal components.

Step 4

Replace your Kuul Comfort evaporative media by beginning on the outer edges and working towards the center. Pay close attention to the stickers on the evaporative media the arrow sticker should point up and inward. Replace the evaporative media flap, securing it with screws.

PARTS

	370	360
MOTOR	PARMTRH3700A	PARMTRH3600A
PUMP	PARPMPH3700A	PARPMPH3600A
MEDIA	PARKULH37000	PARKULH36000
FAN ASSEMBLY	PARFANH370F0	PARFANH360F0
HMI	PARCTLH37000	PARCTLH36000
VFD	PARVFDH37000	-
COVER	PARCVRH37000	-
HARD WATER TREATMENT	PARPACHWTB00	PARPACHWTB00

Additional parts can be found at www.portacoolparts.com

For products sold outside North America, contact Customer Service at 800-695-2942 or email support@portacool.com for item numbers and product availability.

PORTACOOOL™

WHEN COMFORT COUNTS™

CUSTOMER SERVICE CONTACT

1-936-598-5651 * 1-800-695-2942
SUPPORT@PORTACOOOL.COM

TECHNICAL/PARTS CONTACT

1-936-598-5651 * 1-800-695-2942
SUPPORT@PORTACOOOL.COM

VISIT PORTACOOOL.COM
OR CALL 1-936-598-5651
FOR MORE INFORMATION

Portacool, LLC • Manufacturer of Portacool™
portable evaporative coolers and
Kuul® evaporative media
711 FM 2468 • Center, Texas 75935 • 936-598-5651
www.portacool.com • www.thekuuleffect.com

The manual is available in other languages.
To download a digital copy, please visit
www.portacool.com.

El manual está disponible en otros idiomas.
Para descargar una copia digital, por favor
visite www.portacool.com.

Le manuel est disponible en d'autres langues.
Pour télécharger une copie numérique, se il
vous plaît visitez www.portacool.com.

MANR0016
Dec 17

REGISTER YOUR PRODUCT AT WWW.PORTACOOOL.COM

One (1) free hat will be sent to the address given when registration is completed.