

PANDUIT®

Best Seller and Featured Parts Catalog



Industrial Electrical Infrastructure North America



Best Seller and Featured Products for Industrial Construction, MRO and OEM

Partner with a company committed to meeting the daily challenges you face. Panduit offers a full solution of **Best Seller and Featured Products** – from cable ties to power connectors, terminals to identification – Panduit products are engineered for all aspects of designing, installing and maintaining infrastructures within heavy-duty industrial environments. Our robust partner ecosystem, global staff, unmatched service and support make Panduit a valuable and trusted partner.



Proven **QUALITY**
performance



Subject matter
EXPERTISE

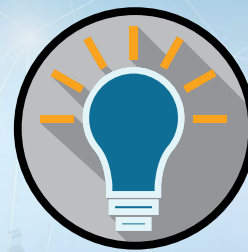

Customer-driven
INNOVATION

For the complete offering, please contact your local Panduit representative or visit us at www.panduit.com

www.panduit.com

< PREVIOUS PAGE | TABLE OF CONTENTS | NEXT PAGE >



Applications and Market Solutions

Commercial Construction

Panduit offers a broad product portfolio across two trusted brands to support contractor needs for the toughest electrical construction applications and environments. The Panduit brand products are engineered for best-in-class safety, reliability and productivity for maximum contractor value and the Stronghold brand products are designed to be reliable, convenient and economical. From power & grounding connectors, to electrical supplies, pre-fab components and wire management products, Panduit is the partner of choice for leading electrical contractors.

Food and Beverage

Food and beverage manufacturers are faced with countless product safety, quality and manufacturing challenges. Maximizing productivity while reducing downtime requires a robust integrated electrical infrastructure that can deliver optimum productivity, reliability and profitability.

Oil and Gas

The world's appetite for energy grows every day, and oil and gas are still the best options for meeting global demand. Faced with the need to explore in challenging locations, integrate new oil sands and shale capabilities, meet updated safety protocols, and identify new technologies to handle remote environments, energy producers are looking for partners who can help them keep up with changing business conditions and goals.

Renewable Energy

Panduit has the proven renewable energy solutions, along with global supply chain and engineering guidance you need to design and build best-in-class solar and wind environments. Our renewable energy electrical infrastructure solutions play a vital role in the world's top renewable energy production facilities. Panduit rigorously tests all solar and wind equipment to ensure outstanding performance in high wind and high vibration operations, under intense UV exposure, in extreme temperatures, and in the presence of corrosive agents.

Safety

As facilities become more complex than ever, managers need solutions that simplify operations and reduce risk. Utilizing a Prevention through Design approach, Panduit is pioneering new ways to protect customer assets, people, and places with revolutionary solutions that unlock efficiency and enable organizations to achieve more.

Transportation

Electrical connectors and wire management products are critical components in vehicles that transport goods or people, from light-rail cars to heavy duty truck and buses for commercial, military, and aerospace industries. Panduit transportation solutions can help you overcome challenges around evolving safety standards and certifications requirements, complex design specifications, and the rigors of harsh environments. Our products withstand vibration, shock, abrasion, and temperature extremes and are tested and certified to meet global standards.

www.panduit.com

< PREVIOUS PAGE | TABLE OF CONTENTS | NEXT PAGE >

Table of Contents

<u>Abrasion Protection</u>	5-13
<u>Cable Cleats</u>	14-18
<u>Cable Ties</u>	19-55
<u>Cable Tie Accessories</u>	56-74
<u>Cable Tie Tools</u>	75-78
<u>Identification Products</u>	79-96
<u>Power Connectors</u>	97-119
<u>Grounding Connectors</u>	120-136
<u>Safety Solutions</u>	137-142
<u>Stainless Steel Ties</u>	143-147
<u>Terminals</u>	148-170
<u>Wiring Duct</u>	171-179

Pan-Wrap™ Split Harness Wrap



- Patented slot pattern provides improved flexibility and abrasion protection in any application
- Unique wall design provides for easy cable breakouts
- Innovative design maintains uniform bundle protection in dynamic applications
- Considerably reduces installation time
- Large overlap accommodates a wide range of bundle diameters
- Packaged on a reel for easy handling and dispensing of product
- UL File: E141152
- Voltage rating: 600 V

Part Number	Material*	Color	Length Per Reel		Max Bundle Diameter		Min. Bundle Diameter‡		Temperature Range	Nominal I.D.		Std. Pkg. Qty.*
			Ft.	m	In.	mm	In.	mm		In.	mm	
PW50F-T	Polyethylene	Natural	200	61.0	0.55	14.0	0.43	10.9	-40°F – 122°F (-40°C – 50°C)	0.50	12.7	1
PW50F-T20		Black										
PW75F-C		Natural	100	30.5	0.81	20.6	0.55	14.0		0.75	19.1	
PW75F-C20		Black										
PW100F-C20	Flame Retardant Polyethylene	Black	100	30.5	1.13	28.6	0.81	20.6	-4°F – 122°F (-20°C – 50°C)	1.00	25.4	
PW100FR-C20Y												

‡Diameter can be further reduced with the use of Panduit cable ties.
*Order number of reels required.

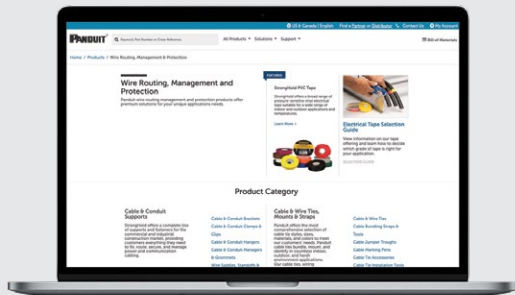

Like what you see? Want more?

Visit www.panduit.com for the full offering of Panduit products

www.panduit.com

Spiral Wrap

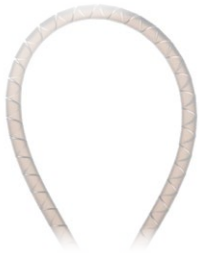

- Installation tool supplied in each package
- Available in multiple materials
- Reusable
- UL File: E141152
- Voltage Rating: 600 V

Part Number	Material*	Color	Length Per Reel‡		Bundle Diameter Range		Outside Diameter		Temperature Range	Wall Thickness		Std. Pkg. Qty.	
			Ft.	m	In.	mm	In.	mm		In.	mm		
BEST SELLER T25F-C	Polyethylene	Natural	100	30.5	3/16 – 2	4.8 – 50.8	0.25	6.4	-40°F – 122°F (-40°C – 50°C)	0.040	1.02	1	
T25F-C3Y		Orange											
T25F-M		Natural	1000	304.8									
BEST SELLER T38F-C			100	30.5	5/16 – 3	7.9 – 76.2	0.38	9.5		0.055	1.40		
T38F-TL		250	76.2	3/8 – 4	9.5 – 101.6	0.50	12.7	0.060		1.52			
BEST SELLER T50F-C		Yellow	100								30.5		
BEST SELLER T50F-C4Y			Natural								250		76.2
T50F-TL		Yellow											
T62F-C		Weather Resistant Polyethylene	Black	100	30.5	1/2 – 4 1/2	12.7 – 114.3	0.62		15.9	0.062		1.57
T75F-C						5/8 – 5	15.9 – 127.0	0.75		19.1	0.065		1.65
T100F-C						7/8 – 6	22.2 – 152.4	1.00		25.4	0.070		1.78
T25F-C0						3/16 – 2	4.8 – 50.8	0.25		6.4	0.040		1.02
T38F-C0				5/16 – 3	7.9 – 76.2	0.38	9.5	0.055		1.40			
BEST SELLER T50F-C0				3/8 – 4	9.5 – 101.6	0.50	12.7	0.060		1.52			
T50F-TL0	250			76.2	5/8 – 5	15.9 – 127.0	0.75	19.1	0.065	1.65			
T75F-C0					7/8 – 6	22.2 – 152.4	1.00	25.4	0.070	1.78			
T100F-C0					3/16 – 2	4.8 – 50.8	0.25	6.4	0.040	1.02			
T25R-CY	Fire Resistant Polyethylene			Natural	100	30.5	3/8 – 4	9.5 – 101.6	0.50	12.7	0.055	1.40	
T50R-CY		3/8 – 4	9.5 – 101.6				0.50	12.7	0.060	1.52			
T50R-TLY		250	76.2		3/16 – 2	4.8 – 50.8	0.25	6.4	0.040	1.02			
T25FR-CY	Flame Retardant Polyethylene	Natural	100	30.5	3/16 – 2	4.8 – 50.8	0.25	6.4	-4°F – 122°F (-20°C – 50°C)	0.040	1.02		
T38FR-C20Y					5/16 – 3	7.9 – 76.2	0.38	9.5		0.055	1.40		
T50FR-CY					3/8 – 4	9.5 – 101.6	0.50	12.7		0.060	1.52		
T50FR-C20Y			250	76.2	3/8 – 4	9.5 – 101.6	0.50	12.7		0.060	1.52		
T50FR-TLY					Natural								
T75FR-CY			100	30.5	5/8 – 5	15.9 – 127.0	0.75	19.1		0.065	1.65		
T75FR-C20Y					Black								
T25N-C	Nylon 6.6	Natural	250	76.2	3/16 – 2	4.8 – 50.8	0.25	6.4	-40°F – 149°F (-40°C – 65°C)	0.023	0.58		
T38N-TL					5/16 – 3	5/16 – 3	0.38	9.5		0.030	0.76		
T25N-C0	Weather Resistant Nylon 6.6	Black	100	30.5	3/16 – 2	4.8 – 50.8	0.25	6.4	-40°F – 239°F (-40°C – 115°C)	0.023	0.58		
T62N-C0					1/2 – 4 1/2	12.7 – 114.3	0.62	15.9		0.035	0.89		
T38P-C0	Weather Resistant Polypropylene	Black	100	30.5	5/16 – 3	7.9 – 76.2	0.38	9.5	-40°F – 239°F (-40°C – 115°C)	0.030	0.76		
T50P-C0					3/8 – 4	9.5 – 101.6	0.50	12.7					

*Flame retardant products are manufactured from a material that is rated UL 94V-0.

‡Reel packaging may contain splices. Contact Panduit Customer Service for further information.

(continued on next page)

Spiral Wrap (continued)

Part Number	Material*	Color	Length Per Reel‡		Bundle Diameter Range		Outside Diameter		Temperature Range	Wall Thickness		Std. Pkg. Qty.
			Ft.	m	In.	mm	In.	mm		In.	mm	
T12T-C	TFE^	Natural	100	30.5	1/16 – 1/2	1.6 – 12.7	0.12	3.2	-454°F – 356°F (-270°C – 180°C)	0.020	0.51	1
T25T-L			50	15.2	3/16 – 2	4.8 – 50.8	0.25	6.4		0.030	0.76	
T38T-L					5/16 – 3	7.9 – 76.2	0.38	9.5				
T50T-Q			25	7.6	3/8 – 4	9.5 – 101.6	0.50	12.7				
T62T-Q					1/2 – 4 1/2	12.7 – 114.3	0.62	15.9				
T75T-X					5/8 – 5	15.9 – 127.0	0.75	19.1				

*Flame retardant products are manufactured from a material that is rated UL 94V-0.
 ‡Reel packaging may contain splices. Contact Panduit Customer Service for further information.
 ^TFE is Polytetrafluoroethylene material.

Grommet Edging

- Use slotted product on irregularly shaped and round panel holes
- Provided in 0.030 inches (0.8mm) thick material making it highly flexible
- Adhesive Lined Grommet Edging: 3 year shelf life

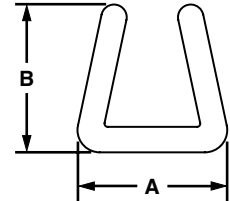
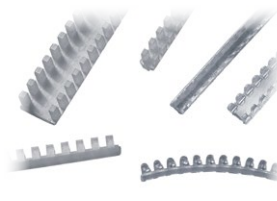
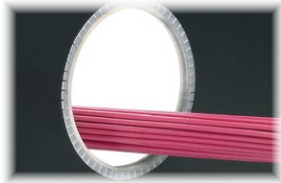

Part Number	Width A		Height B		Panel Thickness Range		Material	Color	Temperature Range	Std. Pkg. Qty.
	In.	mm	In.	mm	In.	mm				

Slotted

GEE62F-C	0.13	3.3	0.16	4.1	0.036 – 0.062	0.9 – 1.6	Polyethylene	Natural*	-40°F – 122°F (-40°C – 50°C)	1
GEE189F-C	0.297	7.55	0.301	7.65	0.144 – 0.189	3.66 – 4.8		Weather Resistant Polyethylene		
GEE189F-C0										

Slotted Adhesive Lined

GEE62F-A-C	0.13	3.3	0.16	4.1	0.036 – 0.062	0.9 – 1.6	Polyethylene	Natural*	-40°F – 122°F (-40°C – 50°C)	1
GEE62F-A-C0							Weather Resistant Polyethylene	Black		
GEE99F-A-C	0.17	4.3	0.19	4.7	0.062 – 0.099	1.6 – 2.5	Polyethylene	Natural*		
GEE99F-A-C0							Weather Resistant Polyethylene	Black		
GEE144F-A-C	0.21	5.4	0.22	5.6	0.099 – 0.144	2.5 – 3.7	Polyethylene	Natural*		
GEE144F-A-C0							Weather Resistant Polyethylene	Black		
GEE189F-A-C	0.297	7.55	0.301	7.65	0.144 – 0.189	3.66 – 4.8	Polyethylene	Natural*		
GEE189F-A-C0							Weather Resistant Polyethylene	Black		

Solid Adhesive Lined – Use on straight edges only

GES62F-A-C	0.13	3.3	0.16	4.1	0.036 – 0.062	0.9 – 1.6	Polyethylene	Natural*	-40°F – 122°F (-40°C – 50°C)	1
GES99F-A-C	0.17	4.3	0.19	4.7	0.062 – 0.099	1.6 – 2.5		Weather Resistant Polyethylene		
GES99F-A-C0										
GES189F-A-C	0.297	7.55	0.301	7.65	0.144 – 0.189	3.66 – 4.8	Polyethylene	Natural*		
GES189F-A-C0							Weather Resistant Polyethylene	Black		

National Aerospace Standard** NAMS21266 in 12.75" Lengths

GE128-C	0.22	5.6	0.16	3.9	0.085 – 0.128	2.2 – 3.3	Nylon 6.6	Natural*	-40°F – 149°F (-40°C – 65°C)	100
GE255-L	0.39	9.8	0.24	6.1	0.192 – 0.255	4.9 – 6.5				50

*Natural color can range from opaque to clear.

Corrugated Loom Tubing



- Provides abrasion resistance as well as light crush and impact resistance
- UV Resistant Corrugated Loom Tubing can be used in outdoor applications

Part Number	Material	Color	Length Per Reel*		Inside Diameter		Outside Diameter		Temperature Range	Std. Pkg. Qty.
			Ft.	m	In.	mm	In.	mm		

UV Resistant Polypropylene Slit Wall

CLT75PUV-0	Polypropylene	Black	4265	1300	0.811	20.60	0.984	25.00	40°F – 185°F (-40°C – 85°C)	1
CLT100PUV-0			2329	710	1.142	29.01	1.358	34.49		
CLT150PUV-0			1542	470	1.417	36.00	1.673	42.49		
CLT188PUV-0			885	270	1.890	48.01	2.146	54.51		

Part Number	Material	Color	Length Per Reel*		Inside Diameter		Outside Diameter		Temperature Range	Std. Pkg. Qty.
			Ft.	m	In.	mm	In.	mm		

Polyethylene Slit Wall

BEST SELLER	CLT25F-C20	Polyethylene	Black	100	30.5	0.28	7.2	0.40	10.1	-40°F – 122°F (-40°C – 50°C)	1			
	CLT38F-C20					0.39	10.0	0.52	13.3					
	CLT50F-C3					Orange	0.51	13.0	0.65			16.6		
	CLT50F-C4												Yellow	
BEST SELLER	CLT50F-C20					Black	0.66	16.9	0.85			21.1		
	CLT62F-C20												Orange	
	CLT75F-C3					Yellow	0.77	19.5	0.94			23.9		
	CLT75F-C4												Black	
BEST SELLER	CLT75F-C20					2000	609.6	0.91	23.2			1.10		28.0
	CLT75F-2M20												Orange	
	CLT100F-C3					Yellow	1.28	32.5	1.54			39.0		
BEST SELLER	CLT100F-C20												Black	
BEST SELLER	CLT125F-L20					50	15.2	1.58	40.0			1.85		47.0
	CLT150F-X4												Yellow	
	CLT150F-X20					Black	200	61.0	1.85			47.0		2.19
	CLT150F-T20												Yellow*	
	CLT188F-C20					10	3.1	1.51	38.4			1.76		44.6
	CLT150F-X4F													

Polyethylene Solid Wall

CLTS25F-C	Polyethylene	Black	100	30.5	0.28	7.2	0.40	10.1	-40°F – 122°F (-40°C – 50°C)	1
-----------	--------------	-------	-----	------	------	-----	------	------	---------------------------------	---

Nylon Slit

CLT25N-C630	Heat Stabilized Nylon 6	Black	100	30.5	0.28	7.2	0.40	10.1	-40°F – 230°F (-40°C – 110°C)	1
CLT50N-C630					0.51	13.0	0.65	16.6		
CLT75N-C630					0.77	19.5	0.94	23.9		

Nylon Solid

CLTS25N-C	Heat Stabilized Nylon 6	Black	100	30.5	0.28	7.2	0.40	10.1	-40°F – 230°F (-40°C – 110°C)	1
-----------	-------------------------	-------	-----	------	------	-----	------	------	----------------------------------	---

*Reel packaging may contain splices. Contact Panduit Customer Service for further information.

*This Yellow matches closely with FiberRunner® Yellow.

www.panduit.com

Braided Expandable Sleeving – Polyethylene Terephthalate (PET)



- Compliant with U.S. and European passenger rail standards
- Rated for use up to 257°F (125°C)
- UL: E116868
- CSA: 227630

Part Number	Color	Nominal I.D.		Nominal Diameter Range		Length Per Reel‡		Std. Pkg. Qty.	Std. Ctn. Qty.
		In.	mm	In.	mm	Ft.	m		
SE12P-TR0	Black	0.12	3.2	0.094 – 0.250	2.4 – 6.4	200	61.0	1	4
SE25P-TR0		0.25	6.4	0.125 – 0.375	3.2 – 9.5	1000	304.8		2
SE25P-MR0		0.38	9.5	0.188 – 0.500	4.8 – 12.7	200	61.0		4
SE38P-TR0		0.38	9.5	0.188 – 0.500	4.8 – 12.7	1000	304.8		2
SE50P-CR0		0.50	12.7	0.250 – 0.750	6.4 – 19.1	100	30.5		4
SE50P-DR0		0.50	12.7	0.250 – 0.750	6.4 – 19.1	500	152.4		2
SE75P-CR0		0.75	19.1	0.500 – 1.25	12.7 – 31.8	100	30.5		4
SE75P-DR0		0.75	19.1	0.500 – 1.25	12.7 – 31.8	500	152.4		2
SE125P-LR0		1.25	31.8	0.750 – 1.50	19.1 – 38.1	50	15.2		4
SE125P-TR0		1.25	31.8	0.750 – 1.50	19.1 – 38.1	200	61.0		2

BEST SELLER

‡Reel packaging may contain splices. Contact Panduit Customer Service for further information.

Braided Expandable Sleeving – Flame Retardant Polyethylene Terephthalate



- Compliant with U.S. and European passenger rail standards
- Rated for use up to 257°F (125°C)
- Flammability: Meets UL 1441 VW-1
- UL E116868
- CSA: 227630

Part Number	Color	Nominal I.D.		Nominal Diameter Range		Length Per Reel‡		Std. Pkg. Qty.	Std. Ctn. Qty.
		In.	mm	In.	mm	Ft.	m		
SE12PFR-TR0	Black	0.12	3.2	0.094 – 0.250	2.4 – 6.4	200	61.0	1	4
SE12PFR-MR0						1000	304.8		2
SE25PFR-TR0		0.25	6.4	0.125 – 0.375	3.2 – 9.5	200	61.0		4
SE25PFR-MR0						1000	304.8		2
SE38PFR-MR0		0.38	9.5	0.188 – 0.500	4.8 – 12.7	200	61.0		4
SE38PFR-TR0						100	30.5		
SE50PFR-CR0		0.50	12.7	0.250 – 0.750	6.4 – 19.1	500	152.4		2
SE50PFR-DR0						100	30.5		
SE75PFR-DR0		0.75	19.1	0.500 – 1.25	12.7 – 31.8	500	152.4		2
SE125PFR-TR0		1.25	31.8	0.750 – 1.50	19.1 – 38.1	200	61.0		

BEST SELLER

‡Reel packaging may contain splices. Contact Panduit Customer Service for further information.

www.panduit.com

Fray Resistant Braided Expandable Sleeving



- Sleeving design resists fraying when cut with scissors
- Provides continuous abrasion protection resistance for wires, cables, and tubing
- Rated for use up to 257°F (125°C)
- Material: Polyethylene Terephthalate
- UL E116868

Part Number	Color	Nominal I.D.		Nominal Diameter Range		Length Per Reel‡		Std. Pkg. Qty.	Std. Ctn. Qty.
		In.	mm	In.	mm	Ft.	m		
SE75PSC-CR0	Black	0.75	19.1	0.63 – 1.0	15.9 – 25.4	100	30.5	1	4

‡Reel packaging may contain splices. Contact Panduit Customer Service for further information.

Pan-Wrap™ Braided Sleeving



- Split wrap design allows for installation after cable routing is complete, breakouts of single and multiple cables, and addition or removal of cables post-installation
- 25% edge overlap ensures complete coverage without opening
- Highly flexible open weave will not trap heat or humidity
- Rated for use up to 257°F (125°C)
- Material: Polyethylene Terephthalate (PET)
- Flammability – Meets UL94V-0

Part Number	Color	Nominal Size Diameter		Nominal Wall Thickness		Length Per Reel		Std. Pkg. Qty.	Std. Ctn. Qty.	
		In.	mm	In.	mm	Ft.	m			
SE38PS-CLR0	Black	0.38	9.7	0.025	0.64	150	45.7	1	2	
SE38PSFR-CLR0										
SE50PS-CLR0		0.50	12.7		0.6					
SE75PS-CR0										
SE100PS-CR0		1.00	25.4	1.0	100	30.5				
SE125PS-LQR0		0.038	1.25	31.8	0.97	75	22.9			
SE125PSFR-LQR0										
SE200PS-LR0										2
SE200PSFR-LR0										

Tinned Copper Braided Sleeving



Part Number	Color	Nominal Diameter		Current Capacity	Length per Roll	
		In.	mm		Ft.	m
SE12TC-C	Silver	0.125	3.2	25	100	30.5
SE25TC-C		0.25	6.4	53		
SE38TC-C		0.375	9.5	62		
SE50TC-L		0.50	12.7	100	50	15.2
SE88TC-L		0.875	22.2	120		
SE100TC-L		1.0	25.4	145		
SE125TC-L		1.25	31.8	165		
SE150TC-L		1.50	38	180		
SE200TC-L		2.0	50.8			

NEW Heavy Duty Nylon Braided Sleeving



Part Number	Color	Nominal Diameter		Minimum Diameter		Maximum Diameter		Length per Roll	
		In.	mm	In.	mm	In.	mm	Ft.	m
SE38N-C	Black	0.375	9.5	0.25	6.4	0.50	12.7	100	30.5
SE50N-C		0.50	12.7	0.375	9.5	0.625	15.9		
SE75N-L		0.75	19.1	0.625	15.9	1.00	25.4		
SE100N-L		1.0	25.4	0.875	22.2	1.25	31.8	50	15.2
SE125N-L		1.25	31.8	1.00	25.4	1.50	38		
SE150N-Q		1.50	38	1.25	31.8	1.75	44.5	25	7.62
SE175N-Q		1.75	44.5	1.50	38	2.00	50.8		
SE200N-Q		2.0	50.8	1.75	44.5	2.75	69.9		
SE300N-Q		3.0	76.2	2.25	57.2	3.50	88.9		

NEW Insulating Fiberglass Tubing



Part Number	Color	Nominal Diameter		Wall Thickness		Length per Roll	
		In.	mm	In.	mm	Ft.	m
FT38-C	Silver	0.375	9.5	0.025	0.6	100	30.5
FT50-C		0.5	12.7				
FT62-C		0.625	15.9				
FT75-C		0.75	19.1				
FT100-C		1.0	25.4				
FT125-C		1.25	31.8				
FT150-C		1.5	38				
FT200-L		2.0	50.8			50	15.2
FT300-L		3.0	76.2				

Duct Seal – Sealing Compounds



- Dielectric strength: 200 V/Mil, Min 0.030 inches thick
- Temperature range: -30°F – 210°F (-34°C – 98°C)
- 10 year minimum shelf life
- Indoor use only

Part Number	Description	Std. Pkg. Qty.
DS1	Duct seal (sealing compound) 1 lb. package	1
DS5	Duct seal (sealing compound) 5 lb. package	

Heat Shrink End Caps



- Applications include insulating and protecting wires and cables
- Adhesive lined inner wall seals and provides excellent protection against moisture
- Voltage rating of 600 V
- Shrink ratio: 2.5:1 (HSEC)
- Temperature range: HSEC: -40°F to 257°F (-40°C to 125°C)
- For wet locations
- Material: Adhesive lined black cross-linked Polyolefin
- 10 year shelf life***

Part Number	Min. Expanded I.D.		Max. Recovered I.D.		Nominal Recovered Wall Thickness		Usable Cap Length		Std. Pkg. Qty.	Std. Ctn. Qty.
	In.	mm	In.	mm	In.	mm	In.	mm		
HSEC0.5-X	0.47	11.9	0.18	4.6	0.09	2.2	1.48	37.6	10	100
HSEC0.8-X	0.79	20.1	0.30	7.6	0.10	2.4	1.79	45.5		

***Shelf life applies only to expanded and recovered dimensions. Material performance is not affected.

UL® HSTT Heat Shrink 4 Foot Pieces and Reels

- Applications include insulating, protecting, and color coding wires and cables
- Voltage: 600 V
- Shrink ratio: 2:1
- Flammability: Flame retardant EXCEPT clear
- Color: Black
- Mil Spec: AMS-DTL-23053/5 Class 1 (Colors) Class 2 (Clear)**
- Temperature range: -67°F to 275°F (-55°C to 135°C)
- For dry locations
- Material: Cross-linked Polyolefin
- UL: E122770 (Except Clear)
- CSA: 222627
- 5 year shelf life***



Part Number	Nominal Expanded I.D.		Max. Recovered I.D.		Nominal Recovered Wall Thickness		Length		Length Per Reel		Std. Pkg. Qty.	Std. Ctn. Qty.
	In.	mm	In.	mm	In.	mm	Ft.	m	Ft.	m		
HSTT06-C	0.063	1.6	0.031	0.8	0.017	0.4	—	—	100	30.5	1	10
HSTT12-C	0.125	3.2	0.062	1.6	0.020	0.5	—	—	—	—	25	—
HSTT19-48-Q	0.187	4.8	0.093	2.4			4	1.2	—	—		
HSTT25-48-Q	0.250	6.4	0.125	3.2	0.025	0.6	—	—	100	30.5	1	10
HSTT25-C‡							—	—	—	—	—	—
HSTT38-48-Q	0.375	9.5	0.187	4.8	0.025	0.6	4	1.2	—	—	25	—
HSTT38-C‡							—	—	100	30.5	1	10
HSTT50-48-5	0.500	12.7	0.250	6.4	0.025	0.6	4	1.2	—	—	5	—
HSTT50-C‡							—	—	100	30.5	1	10
HSTT75-48-5	0.750	19.1	0.375	9.5	0.030	0.8	4	1.2	—	—	5	—
HSTT75-C‡							—	—	100	30.5	1	10
HSTT100-48-5	1.00	25.4	0.500	12.7	0.035	0.9	4	1.2	—	—	5	—
HSTT100-C‡							—	—	100	30.5	1	2
HSTT150-48-5	1.50	38.1	0.750	19.1	0.040	1.0	4	1.2	—	—	5	—
HSTT150-C‡							—	—	100	30.5	1	2
HSTT200-48-5	2.00	50.8	1.00	25.4	0.045	1.1	4	1.2	—	—	5	—
HSTT200-L‡							—	—	50	15.2	1	2
HSTT300-L‡	3.00	76.2	1.50	38.1	0.050	1.3	—	—	—	—	1	0

*For colors, add C (Clear), 1 (Brown), 2 (Red), 3 (Orange), 4 (Yellow), 45 (Yellow/Green), 5 (Green), 6 (Blue) and 10 (White) to end of part number. Contact customer service for availability.

‡Part sold per reel.

**Material Performance Only.

***Shelf life applies only to expanded and recovered dimensions. Material performance is not affected.

HSTTT TFE Heat Shrink 4 Foot Pieces



- Applications include insulating and protecting wires and cables
- Voltage: 600 V
- Shrink ratio: 2:1
- Mil Spec: AMS-DTL-23053/12 Class 2 and 3**
- Temperature range: -88°F to 482°F (-67°C to 250°C)
- Color: Opaque
- For dry locations
- Material: Halogen-Free Polytetrafluoroethylene (TFE)
- High temperature; resists corrosive atmosphere
- 4 year shelf life***

Part Number	Nominal Diameter		Nominal Expanded I.D.		Max. Recovered I.D.		Nominal Recovered Wall Thickness		Length		Std. Pkg. Qty.
	In.	mm	In.	mm	In.	mm	In.	mm	Ft.	m	
HSTTT08-48-Q	18 AWG	1.9	0.076	1.9	0.049	1.2	0.012	0.3	4	1.2	25

**Material Performance Only.

***Shelf life applies only to expanded and recovered dimensions. Material performance is not affected.

www.panduit.com

HSTTA Heat Shrink 4 Foot (1.22m) Pieces

- Applications include insulating and protecting wires and cables
- Flexible tubing with an adhesive inner wall which seals and protects components from moisture and corrosion
- Voltage rating: 600 V
- Shrink ratio: 3:1
- Flammability: Outer wall flame retardant
- Mil Spec: AMS-DTL-23053/4 Class 3**
- Temperature range: -67°F to 230°F (-55°C to 110°C)
- For damp locations
- Material: Adhesive lined black cross-linked Polyolefin
- UL: E342365
- 5 year shelf life***



Part Number	Min Expanded I.D.		Max Recovered I.D.		Nominal Recovered Wall Thickness		Std. Pkg. Qty.	Std. Ctn. Qty.
	In.	mm	In.	mm	In.	mm		
HSTTA25-48-TL	0.250	6.4	0.080	2.0	0.040	1.0	250	—
HSTTA50-48-5	0.500	12.7	0.160	4.1	0.070	1.8	5	
HSTTA75-48-5	0.750	19.1	0.250	6.4	0.085	2.2		
HSTTA100-48-5	1.00	25.4	0.320	8.1	0.100	2.5		
HSTTA150-48-Q	1.50	38.1	0.510	12.9	0.100			

**Material Performance Only.

***Shelf life applies only to expanded and recovered dimensions. Material performance is not affected.



HST Thick Wall Polyolefin Heat Shrink

- Applications include insulating and protecting wires and cables
- Adhesive-lined inner wall seals and protects against moisture
- Thick wall suitable for direct burial according to UL 486D and provides excellent protection
- Voltage rating: UL 486D Listed for 600 V 90°C continuous use
- Shrink ratio: 3:1
- Flammability: Flame retardant outer wall meets UL 224 VW-1
- UL/UR: E342365
- UL Listed: E173379
- CSA 244528
- Mil Spec: AMS-DTL-23053/15**
- Temperature range: -67°F to 230°F (-55°C to 110°C)
- Suitable for wet locations; Black HST suitable for outdoor, direct sunlight applications
- Material: Adhesive lined black and red cross-linked Polyolefin
- 10 year shelf life***



Part Number	Min Expanded I.D.		Max Recovered I.D.		Nominal Recovered Wall Thickness		Length		Color	Std. Pkg. Qty.	Std. Ctn. Qty.	
	In.	mm	In.	mm	In.	mm	In.	mm				
HST0.4-48-5Y*	0.40	10.2	0.16	4.1	0.08	2.0	48.0	1219.2	Black	5	20	
HST0.8-48-5Y*	0.75	19.1	0.22	5.6	0.09	2.3				6.0	152.4	10
HST0.8-6-XY*							5	20				
HST1.1-48-5Y	1.10	27.9	0.38	9.5	0.12	3.0	48.0	1219.2		5	15	
HST1.5-48-5Y	1.50	38.1	0.50	12.7	0.16	4.1				1219.2	5	15
HST2.0-48-2Y	2.00	50.8	0.67	16.9							2	8

The following parts are not UL listed, UL recognized or CSA certified

HST3.0-48-2	3.00	76.2	1.00	25.4	0.16	4.1	48.0	1219.2	Black	2	8
-------------	------	------	------	------	------	-----	------	--------	-------	---	---

*Product meets performance requirements of AMS-DTL-23053/15; some dimensions differ from specification.

**Material Performance Only.

***Shelf life applies only to expanded and recovered dimensions. Material performance is not affected.

Strapping Cable Cleats

- Inherent cable range taking, compatible with quad, trefoil, and single/multicore cables
- Strapping cleats made from 304 or 316L stainless steel
- Cushion sleeve options available as reels for custom-length applications or discrete lengths providing intuitive quick and easy installation.
- Uniclip Brackets feature high resistance to lateral and axial movement, eliminate diagonal installations, and allows Panduit stainless steel ties and straps to be installed on any style or design of cable tray; slotted or unslotted

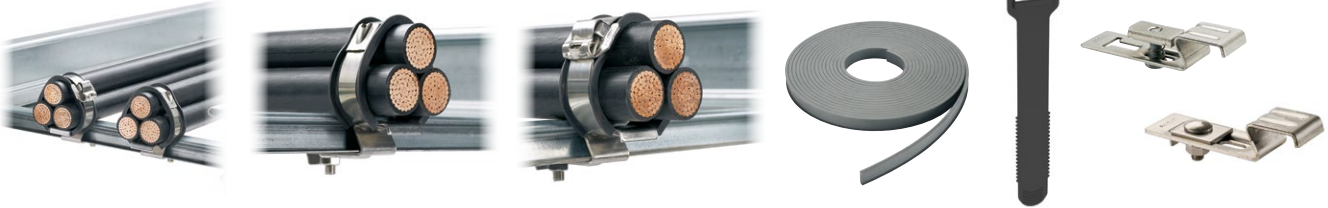

Locking Strap Cable Cleat

Part Number	Flat/Multicore Double Loop Cable Diameter Range		Trefoil Double Loop Cable Diameter Range		Quad Double Loop Cable Diameter Range		Width		Std. Pkg. Qty.
	In.	mm	In.	mm	In.	mm	In.	mm	
MLT4DEH15-Q316	0.47 – 3.62	12 – 92	0.47 – 1.85	12 – 47	0.47 – 1.57	12 – 40	0.50	12.70	25
MLT4DSH-Q316							0.63	15.90	
MLT6DEH15-Q316	3.62 – 5.51	92 – 140	1.85 – 2.80	47 – 71	1.57 – 2.40	40 – 61	0.50	12.70	
MLT6DSH-Q316							0.62	15.90	
MLT8DEH15-Q316	5.51 – 7.68	140 – 195	2.80 – 3.94	71 – 100	2.40 – 3.27	61 – 83	0.50	12.70	
MLT8DSH-Q316							0.63	15.90	

Buckle Strap Cable Cleat

Part Number	Flat/Multicore Double Loop Cable Diameter Range		Flat/Multicore Triple Loop Cable Diameter Range		Trefoil Double Loop Cable Diameter Range		Trefoil Triple Loop Cable Diameter Range		Quad Double Loop Cable Diameter Range		Quad Triple Loop Cable Diameter Range		Width		Std. Pkg. Qty.
	In.	mm	In.	mm	In.	mm	In.	mm	In.	mm	In.	mm	In.	mm	
MS4W75T30-Q6	0.47–2.05	12–52	0.47–1.34	12–34	0.47–1.02	12–26	0.47–0.67	12–17	0.47–0.87	12–22	0.47–0.59	12–15	0.75	19.10	25
MS6W75T30-Q6	2.05–3.03	52–77	1.34–2.01	34–51	1.02–1.54	26–39	0.67–1.02	17–26	0.87–1.34	22–34	0.59–0.87	15–22			
MS8W75T30-Q6	3.03–4.02	77–102	2.01–2.68	51–68	1.54–2.05	39–52	1.02–1.38	26–35	1.34–1.77	34–45	0.87–1.18	22–30			
MS10W75T30-Q6	4.02–5.04	102–128	2.68–3.35	68–85	2.05–2.56	52–65	1.38–1.69	35–43	1.77–2.20	45–56	1.18–1.46	30–37			
MS12W75T30-Q6	5.04–6.02	128–153	3.35–4.02	85–102	2.56–3.07	65–78	1.69–2.05	43–52	2.20–2.64	56–67	1.46–1.77	37–45			
MS14W75T30-Q6	6.02–6.89	153–175	4.02–4.61	102–117	3.07–3.50	78–89	2.05–2.32	52–59	2.64–3.03	67–77	1.77–2.01	45–51			

Individual Cushion Sleeve

Part Number	Flat/Multicore Cable Diameter Range		Trefoil Cable Diameter Range		Quad Cable Diameter Range		Length		Width		Thickness		Std. Pkg. Qty.
	In.	mm	In.	mm	In.	mm	In.	mm	In.	mm	In.	mm	
CSB42-150-230-Q	1.38 – 2.75	35 – 70	0.71 – 1.26	18 – 32	0.63 – 1.14	16 – 29	10.80	274	2.62	66.70	0.10	2.50	25
CSB42-230-330-Q	2.75 – 3.94	70 – 100	1.26 – 1.97	32 – 50	1.14 – 1.73	29 – 44	14.80	376					
CSB42-330-430-Q	3.94 – 5.12	100 – 130	1.97 – 2.75	50 – 70	1.73 – 2.28	44 – 58	18.80	478					

(continued on next page)

Strapping Cable Cleats (continued)

Cushion Sleeve

BEST SELLER
BEST SELLER

Part Number	Material	Length		Width		Thickness		Std. Pkg. Qty.
		Ft.	m	In.	mm	In.	mm	
PCSLSH-B-CR	TPE Low Smoke, Halogen Free	100	30.5	1.05	26.8	0.08	2.2	1
PCSSH-B-CR	Neoprene			0.91	23.1	0.12	3.1	

UC Series Brackets

Part Number	Description	Std. Pkg. Qty.
UCSQ1-V316	Mounting bracket – Strut Type, 316L stainless steel	5
UCIB1-V316	Mounting bracket - I-Beam, 316L stainless steel	
UCTH1-V316	Mounting Bracket - Top Hat Type, 316L Stainless Steel	

Stainless Steel Cable Cleats

- Cable range taking capability, compatible with trefoil and quad cable arrangements
- Cable Cleats are made from 316/316L stainless steel and spacers are made from low-smoke, halogen free TPE
- Metal Cable Cleat Brackets are made from 316/316L stainless steel

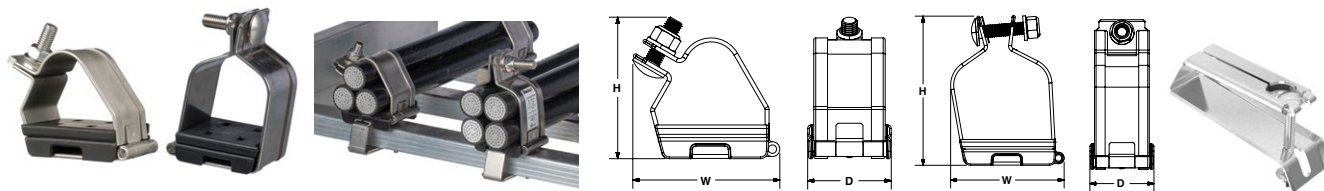

Stainless Steel Trefoil Cable Cleats

Part Number	Cable Diameter Range		H		W		D		Weight		Mounting Holes	Std. Pkg. Qty.
	In.	mm	In.	mm	In.	mm	In.	mm	lb.	g		
CCSSTR2025-X	0.79 – 0.98	20 – 25	3.43	87	3.39	86	2.48	63	0.92	417	1 X M8	10
CCSSTR2328-X	0.91 – 1.10	23 – 28	3.58	91	3.54	90			0.97	439		
CCSSTR2632-X	1.02 – 1.26	26 – 32	3.74	95	3.82	97			1.06	480		
CCSSTR3036-X	1.18 – 1.42	30 – 36	3.94	100	4.13	105			1.14	518		
CCSSTR3440-X	1.34 – 1.58	34 – 40	4.25	108	4.37	111			1.21	547		
CCSSTR3844-X	1.50 – 1.73	38 – 44			4.69	119			1.28	581		
CCSSTR4248-X	1.65 – 1.89	42 – 48	4.41	112	4.96	126			1.35	613		
CCSSTR4652-X	1.81 – 2.05	46 – 52	4.61	117	5.24	133			1.43	647		
CCSSTR5057-X	1.97 – 2.24	50 – 57	4.84	123	5.63	143			1.51	686		
CCSSTR5461-X	2.13 – 2.40	54 – 61	5.12	130	5.91	150			1.59	720		
CCSSTR5865-X	2.28 – 2.56	58 – 65	5.43	138	6.18	157			1.66	754		
CCSSTR6269-X	2.44 – 2.72	62 – 69	5.71	145	6.50	165			1.72	782		

Stainless Steel Quad Cable Cleat

Part Number	Cable Diameter Range		H		W		D		Weight		Mounting Holes	Std. Pkg. Qty.
	In.	mm	In.	mm	In.	mm	In.	mm	Lb.	g		
CCSSQD2226-X	0.87 – 1.02	22 – 26	4.06	103	2.76	70	2.48	63	0.89	404	1 x M8	10
CCSSQD2529-X	0.98 – 1.14	25 – 29	4.41	112	3.03	77	2.48	63	0.94	426		
CCSSQD2834-X	1.10 – 1.34	28 – 34	4.80	122	3.46	88	2.48	63	1.05	477		
CCSSQD3339-X	1.30 – 1.54	33 – 39	5.31	135	3.98	101	2.48	63	1.13	512		
CCSSQD3844-X	1.50 – 1.73	38 – 44	5.79	147	4.41	112	2.48	63	1.25	566		

(continued on next page)

www.panduit.com

Stainless Steel Cable Cleats *(continued)*

CBH Series Brackets

Part Number	Description	Rung Height		Rung Width		Part Weight	
		In.	mm	In.	mm	lb.	g
CBH15L50-V6	Cleat bracket, height 15 mm, length 50 mm, 316L stainless steel.	0.00 – 0.59	0 – 15	1.97	50	0.32	145
CBH20L50-V6	Cleat bracket, height 20 mm, length 50 mm, 316L stainless steel.	0.59 – 0.79	15 – 20				
CBH25L50-V6	Cleat bracket, height 25 mm, length 50 mm, 316L stainless steel.	0.79 – 0.98	20 – 25			0.33	151
CBH30L50-V6	Cleat bracket, height 30 mm, length 50 mm, 316L stainless steel.	0.98 – 1.18	25 – 30				

Aluminum Cable Cleats

- Features rounded edges for cable protection and ridges to hold cabling in place
- Hinged trefoil cleats are designed for additional cable range-taking and nylon insert lock nut assists in vibration dampening
- One-hole and two-hole cleats are designed to be installed on the cable tray run via fixing hole(s) and user-supplied M10 bolt(s)

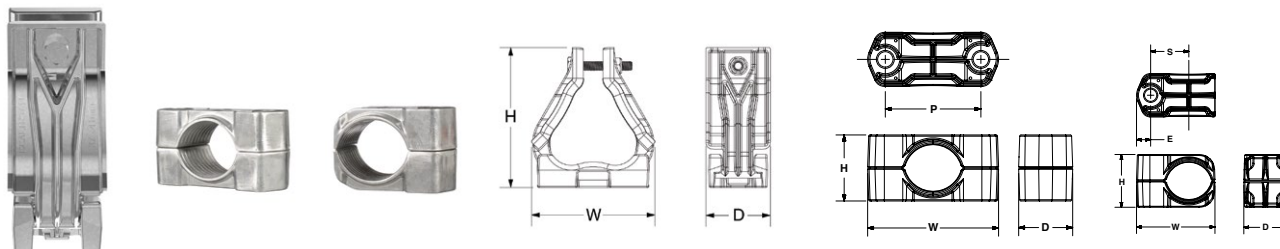

Aluminum Trefoil Cable Cleat

Part Number	Cable Diameter Range		H		W		D		Weight		Mounting Holes	Std. Pkg. Qty.
	In.	mm	In.	mm	In.	mm	In.	mm	lb.	g		
CCALTR2326-X	0.91 – 1.02	23 – 26	3.94	100	3.98	101	2.17	55	0.81	370	1 x M8	10
CCALTR2528-X	0.98 – 1.10	25 – 28	4.06	103	4.13	105			0.85	385		
CCALTR2730-X	1.06 – 1.18	27 – 30	4.21	107	3.85	98			0.87	397		
CCALTR2932-X	1.14 – 1.26	29 – 32	4.33	110	0.92	418						
CCALTR3135-X	1.22 – 1.38	31 – 35	1.57	116	3.97	101			0.93	424		
CCALTR3438-X	1.34 – 1.50	34 – 38	4.76	121	4.18	106			0.98	448		
CCALTR3741-X	1.46 – 1.61	37 – 41	4.99	127	4.41	112			1.05	477		
CCALTR4044-X	1.57 – 1.73	40 – 44	5.24	133	4.64	118			1.14	516		
CCALTR4347-X	1.69 – 1.85	43 – 47	5.52	140	4.85	123			1.23	558		
CCALTR4651-X	1.81 – 2.01	46 – 51	5.83	148	5.05	128			1.32	602		
CCALTR5056-X	1.97 – 2.20	50 – 56	6.22	158	5.50	140			1.42	647		
CCALTR5561-X	2.17 – 2.40	55 – 61	6.57	167	5.72	145			1.55	706		
CCALTR6067-X	2.36 – 2.64	60 – 67	7.01	178	6.15	156			1.73	787		
CCALTR6675-X	2.60 – 2.95	66 – 75	7.6	193	6.72	171						

(continued on next page)

Aluminum Cable Cleats (continued)

Aluminum Two-Hole Cable Cleat

Part Number	Cable Diameter Range		H		W		D		P		Weight		Mounting Holes	Std. Pkg. Qty.
	In.	mm	In.	mm	In.	mm	In.	mm	In.	mm	lb.	g		
CCAL2H3846-X	1.50 – 1.81	38 – 46	2.01	51	3.98	101	1.64	42	2.91	74	0.50	226	2 x M10	10
CCAL2H4658-X	1.81 – 2.28	46 – 58	2.36	60	4.52	115	1.69	43	3.39	86	0.64	291		
CCAL2H5870-X	2.28 – 2.76	58 – 70	2.87	73	5.20	132	1.77	45	3.97	101	0.89	404		
CCAL2H7083-X	2.76 – 3.27	70 – 83	3.39	86	5.71	145	1.81	46	4.48	114	1.09	496		
CCAL2H8397-X	3.27 – 3.82	83 – 97	3.94	100	6.37	162	1.85	47	5.07	129	1.39	630		
CCAL2H97109-X	3.82 – 4.29	97 – 109	4.53	115	3.89	175	1.93	49	5.55	141	1.66	754		
CCAL2H109120-X	4.29 – 4.72	109 – 120	5.04	128	7.33	186	1.98	50	5.99	152	1.92	873		

Aluminum One-Hole Cable Cleat

Part Number	Cable Diameter Range		H		W		D		E		S		Weight		Mounting Holes	Std. Pkg. Qty.
	In.	mm	In.	mm	In.	mm	In.	mm	In.	mm	In.	mm	lb.	g		
CCAL1H1013-X	0.39 – 0.51	10 – 13	0.91	23	1.57	40	1.61	41	0.48	12	0.79	20	0.11	50	1 x M10	10
CCAL1H1316-X	0.51 – 0.63	13 – 16	1.02	26	1.72	44	1.61	41	0.48	12	0.83	21	0.13	59		
CCAL1H1619-X	0.63 – 0.75	16 – 19	1.14	29	1.88	48	1.61	41	0.51	13	0.91	23	0.15	68		
CCAL1H1923-X	0.75 – 0.91	19 – 23	1.26	32	2.04	52	1.61	41	0.51	13	0.99	25	0.17	77		
CCAL1H2327-X	0.91 – 1.06	23 – 27	1.42	36	2.28	58	1.61	41	0.51	13	1.07	27	0.20	89		
CCAL1H2732-X	1.06 – 1.26	27 – 32	1.57	40	2.44	62	1.61	41	0.55	14	1.19	30	0.24	107		
CCAL1H3238-X	1.26 – 1.50	32 – 38	1.77	45	2.68	68	1.65	42	0.55	14	1.30	33	0.27	125		
CCAL1H3846-X	1.50 – 1.81	38 – 46	2.01	51	2.98	76	1.65	42	0.55	14	1.45	37	0.33	149		
CCAL1H4651-X	1.81 – 2.01	46 – 51	2.36	60	3.26	83	1.65	42	0.55	14	1.58	40	0.40	181		
CCAL1H5157-X	2.01 – 2.24	51 – 57	2.56	65	3.49	89	1.66	42	0.55	14	1.70	43	0.44	202		

Polymer Cable Cleats

- Features rounded edges for cable protection and ridges to hold cabling in place
- Construction features corrosion resistant body

- Cable cleats are designed to be installed on the cable tray run via fixing hole(s) and user-supplied M10 bolt(s)

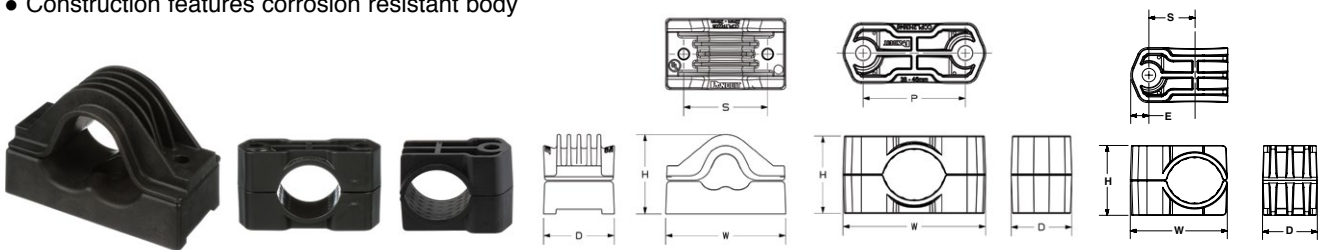

Polymer Trefoil Cable Cleat

Part Number	Cable Diameter Range		H		W		D		S		Weight		Mounting Holes	Std. Pkg. Qty.
	In.	mm	In.	mm	In.	mm	In.	mm	In.	mm	lb.	g		
CCPLTR2228-X	0.87 – 1.10	22 – 28	3.46	88	5.20	132	3.07	78	3.62	92	1.29	585	1 X M10, 2 X M10	10
CCPLTR2633-X	1.02 – 1.30	26 – 33	3.86	98	5.59	142			4.02	102	1.39	630		
CCPLTR3139-X	1.22 – 1.54	31 – 39	4.13	105	6.06	154			4.49	114	1.51	685		
CCPLTR3745-X	1.46 – 1.77	37 – 45	4.61	117	6.54	166			4.96	126	1.64	745		
CCPLTR4352-X	1.69 – 2.05	43 – 52	5.04	128	7.09	180			5.51	140	1.80	815		
CCPLTR5060-X	1.97 – 2.36	50 – 60	5.55	141	7.76	197			6.14	156	1.97	895		

(continued on next page)

Polymer Cable Cleats (continued)

Polymer Two-Hole Cable Cleat

Part Number	Cable Diameter Range		H		W		D		P		Weight		Mounting Holes	Std. Pkg. Qty.
	In.	mm	In.	mm	In.	mm	In.	mm	In.	mm	lb.	g		
CCPL2H3846-X	1.50 – 1.81	38 – 46	2.20	56	4.07	103	1.73	44	2.92	74	0.31	143	2 x M10	10
CCPL2H4658-X	1.81 – 2.28	46 – 58	2.56	65	4.53	115	1.74	44	3.37	86	0.38	175		
CCPL2H5870-X	2.28 – 2.76	58 – 70	3.07	78	5.04	128	1.76	45	3.85	98	0.48	220		
CCPL2H7083-X	2.76 – 3.27	70 – 83	3.19	81	5.56	141	1.85	47	4.36	111	0.60	273		
CCPL2H8397-X	3.27 – 3.82	83 – 97	4.13	105	6.13	156	1.95	50	4.91	125	0.74	335		
CCPL2H97109-X	3.82 – 4.29	97 – 109	4.72	120	6.64	169	2.06		5.40	137	0.88	402		
CCPL2H109120-X	4.29 – 4.72	109 – 120	5.24	133	7.10	180	2.09	53	5.84	148	1.01	460		
CCPL2H120135-X	4.72 – 5.31	120 – 135	5.71	145	7.69	195	2.17	55	6.42	163	1.17	533		
CCPL2H135150-X	5.31 – 5.91	135 – 150	6.34	161	8.31	211	2.19	56	7.01	178	1.35	615		
CCPL2H150165-X	5.91 – 6.50	150 – 165	6.97	177	8.92	227	2.29	58	7.61	193	1.57	712		

Polymer One-Hole Cable Cleat

Part Number	Cable Diameter Range		H		W		D		E		S		Weight		Mounting Holes	Std. Pkg. Qty.
	In.	mm	In.	mm	In.	mm	In.	mm	In.	mm	In.	mm	lb.	g		
CCPL1H1013-X	0.39 – 0.51	10 – 13	1.10	28	1.74	44	1.69	43	0.56	14	0.83	21	0.08	38	1 x M10	10
CCPL1H1316-X	0.51 – 0.63	13 – 16	1.22	31	1.87	48					0.87	22	0.10	44		
CCPL1H1619-X	0.63 – 0.75	16 – 19	1.34	34	2.00	51					0.94	24	0.11	49		
CCPL1H1923-X	0.75 – 0.91	19 – 23	1.46	37	2.15	55					1.01	26	0.12	56		
CCPL1H2327-X	0.91 – 1.06	23 – 27	1.61	41	2.32	59					1.09	28	0.14	63		
CCPL1H2732-X	1.06 – 1.26	27 – 32	1.77	45	2.52	64	1.73	44	0.55	15	1.19	30	0.16	72		
CCPL1H3238-X	1.26 – 1.50	32 – 38	1.97	50	2.75	70					1.31	33	0.18	82		
CCPL1H3846-X	1.50 – 1.81	38 – 46	2.28	58	3.06	78					1.46	37	0.21	96		
CCPL1H4651-X	1.81 – 2.01	46 – 51	2.56	65	3.29	84					1.57	40	0.25	114		
CCPL1H5157-X	2.01 – 2.24	51 – 57	2.76	70	3.53	90					1.69	43	0.28	125		

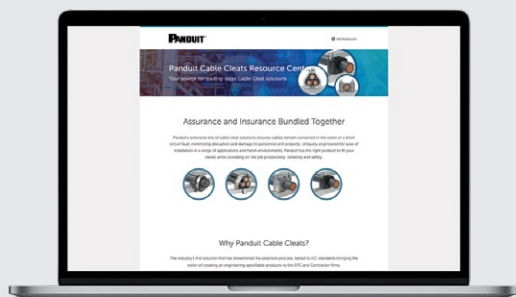

**Like what you see?
Want more?**

Visit www.panduit.com for the full offering of Panduit products

Panduit Cable Ties

Panduit® offers the most comprehensive selection of cable tie styles, sizes, materials, and colors to meet the needs of our customers. Our cable ties bundle, mount, and identify in countless indoor, outdoor, and harsh environment applications.



Most Popular Cable Tie Styles

Cable Tie Style	Description
Panduit Locking Cable Ties	Designed to satisfy the needs of general applications, while delivering consistent performance and reliability. Featuring a curved tip to allow for easy pick up from flat surfaces and faster initial threading.
Panduit Dome-Top® Barb Tys	Features a unique patented design with its round smooth edges. Paired with the stainless steel locking barb, these cable ties provide consistent performance, reliability and infinite adjustability through the entire bundle range.
Panduit Releasable Cable Ties	The release tab permits easy release where changes are anticipated during development, production or servicing in the field. Ideal for heavy duty applications.

Most Popular Cable Tie Materials

Cable Tie Material	Description	Continuous Use Temperature Rating
Nylon 6.6	Nylon 6.6 material is very versatile and can be used in countless applications. Because of the plenum rating Nylon 6.6 cable ties can be used in air handling spaces. Designed to be used in indoor environments only.	-76°F (-60°C) to 185°F (85°C)
Weather Resistant Nylon 6.6	Weather Resistant Nylon 6.6 material has great resistance to damage caused by ultraviolet light and can be used in both indoor and outdoor environments.	-76°F (-60°C) to 185°F (85°C)
Heat Stabilized Nylon 6.6	Heat Stabilized material is designed for high temperature applications in indoor environments only.	-76°F (-60°C) to 239°F (115°C)
Metal Detectable Nylon 6.6	Metal Detectable material is designed to help the food, beverage and pharmaceutical industries meet product manufacturing standards. The metal impregnated material is identifiable by metal detection equipment and is for indoor use only.	-40°F (-40°C) to 185°F (85°C)
Tefzel	Tefzel material is ideal for applications requiring resistance to environmental stresses such as: chemical attack, gamma radiation, ultraviolet radiation, and extreme high and low temperatures, can be used in both indoor and outdoor environments.	-76°F (-60°C) to 338°F (170°C)



Panduit Locking Tie Cable Ties – Nylon 6.6

- For indoor use
- Versatile cable ties can be used in countless applications
- One-piece construction for consistent performance and reliability
- Among the lowest threading force of any one-piece cable tie in the industry
- Curved tip is easy to pick up from flat surfaces and allows faster initial threading to speed installation
- A variety of materials and colors available for specific applications
- UL Listed for use in plenum or air handling spaces per NEC except PLT.6SM and PLT5H/6H/8H/13H

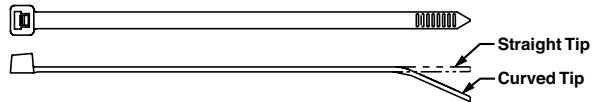
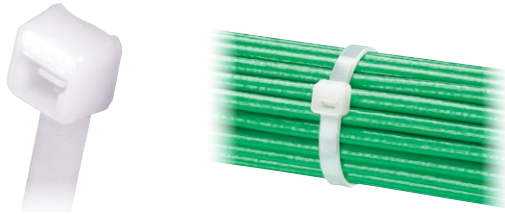

Part Number	Length In. (mm)	Width In. (mm)	Max Bundle Diameter In. (mm)	Material	Color	Resistance Properties	AH-2 Plenum Rated	UL 94 Flammability Rating	UL 62275 Type	Pkg. Qty.	Installation Tools
Subminiature Cable Tie											
PLT.6SM-C	2.8 (71)	0.070 (1.8)	0.60 (15)	Nylon 6.6	Natural	—	—	V-2	1, 11	100	GTS-E, PTS
Miniature Cross Section											
PLT1M-C	3.9 (99)	0.098 (2.5)	0.87 (22)	Nylon 6.6	Natural	—	✓	V-2	2, 21	100	GTS-E, GS2B-E, PTS, PPTS, STS2
BEST SELLER PLT1M-M	3.9 (99)	0.098 (2.5)	0.87 (22)							1000	
PLT1.5M-C	5.6 (142)	0.098 (2.5)	1.25 (32)							100	
BEST SELLER PLT1.5M-M	5.6 (142)	0.098 (2.5)	1.25 (32)							1000	
PLT2M-C	8.0 (203)	0.098 (2.5)	2.00 (51)							100	
BEST SELLER PLT2M-M	8.0 (203)	0.098 (2.5)	2.00 (51)							1000	
Intermediate Cross Section											
PLT1.5I-C	5.6 (142)	0.142 (3.6)	1.38 (35)	Nylon 6.6	Natural	—	✓	V-2	2, 21	100	GTS-E, GS2B-E, PTS, PPTS, STS2
BEST SELLER PLT1.5I-M	5.6 (142)	0.142 (3.6)	1.38 (35)							1000	
PLT2I-C	8.0 (203)	0.142 (3.6)	2.00 (51)							100	
BEST SELLER PLT2I-M	8.0 (203)	0.142 (3.6)	2.00 (51)							1000	
PLT3I-C	11.4 (290)	0.145 (3.7)	3.00 (76)							100	
PLT4I-C	14.5 (368)	0.145 (3.7)	4.00 (102)							100	
Standard Cross Section											
BEST SELLER PLT2S-C	7.4 (188)	0.190 (4.8)	1.88 (48)	Nylon 6.6	Natural	—	✓	V-2	2, 21, 2S, 21S	100	GTS-E, GS2B-E, GTH-E, GS4H-E, PTS, PPTS, PTH, STS2, STH2
BEST SELLER PLT2S-M	7.4 (188)	0.190 (4.8)	1.88 (48)							1000	
BEST SELLER PLT3S-C	11.5 (292)	0.190 (4.8)	3.00 (76)							100	
BEST SELLER PLT3S-M	11.5 (292)	0.190 (4.8)	3.00 (76)							1000	
BEST SELLER PLT4S-C	14.5 (368)	0.190 (4.8)	4.00 (102)							100	
BEST SELLER PLT4S-M	14.5 (368)	0.190 (4.8)	4.00 (102)							1000	
BEST SELLER PLT5S-C	17.5 (445)	0.190 (4.8)	5.00 (127)							100	



Panduit Locking Tie Cable Ties – Nylon 6.6 (continued)

Part Number	Length In. (mm)	Width In. (mm)	Max Bundle Diameter In. (mm)	Material	Color	Resistance Properties	AH-2 Plenum Rated	UL 94 Flammability Rating	UL 62275 Type	Pkg. Qty.	Installation Tools
Light-Heavy Cross Section (Straight Tip)											
PLT4H-L	14.5 (368)	0.300 (7.6)	4.00 (102)	Nylon 6.6	Natural	—	✓	V-2	2, 21	50	GTH-E, GS4H-E, GS4EH-E, PTH, STH2, ST3EH
PLT6LH-L	21.9 (556)	0.300 (7.6)	6.00 (152)								
PLT7LH-L	24.7 (627)	0.300 (7.6)	7.00 (178)								
PLT9LH-L*	30.5 (775)	0.300 (7.6)	9.00 (229)								

Heavy Cross Section (Straight Tip)											
PLT5H-L*	17.7 (450)	0.350 (8.9)	5.00 (127)	Nylon 6.6	Natural	—	—	V-2	1, 11	50	GTH-E, GS4H-E, GS4EH-E, PTH, STH2, ST3EH
PLT6H-L*	20.9 (530)	0.350 (8.9)	6.00 (152)								
PLT8H-L*	30.6 (779)	0.350 (8.9)	9.00 (229)								
PLT13H-Q*	43.3 (1100)	0.350 (8.9)	13.00 (330)								

*UL Listed – meets the requirements of UL 181B-C, for securing UL Listed non-metallic air ducts and air connectors.



Panduit Locking Tie Lashing Ties – Nylon 6.6

- For indoor use
- Typically used for heavy duty applications
- Among the strongest Panduit Locking Tie Cable Tie available
- Can be used with MCEH mounting clip
- UL Listed for use in plenum or air handling spaces per NEC except PLT.6SM and PLT5H/6H/8H/13H

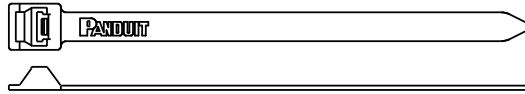

Extra-Heavy Cross Section

Part Number	Length In. (mm)	Width In. (mm)	Max. Bundle Dia. In. (mm)	Material	Color	Resistance Properties	AH-2 Plenum Rated	UL 94 Flammability Rating	UL 62275 Type	Pkg. Qty.	Installation Tools
PLT12EH-C	40.1 (1019)	0.500 (12.7)	12.00 (305)	Nylon 6.6	Natural	—	✓	V-2	2, 21	100	GS4EH-E, ST3EH

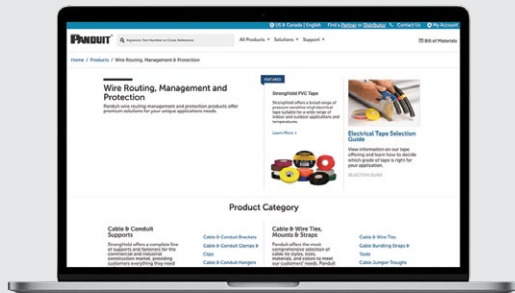

Like what you see? Want more?

Visit www.panduit.com for the full offering of Panduit products

www.panduit.com



Panduit Locking Tie Cable Ties – Weather Resistant Nylon 6.6

- Greater resistance to damage caused by ultraviolet light – indoor or outdoor use
- Versatile cable ties can be used in countless applications
- One-piece construction for consistent performance and reliability
- Among the lowest threading force of any one-piece cable tie in the industry
- Curved tip is easy to pick up from flat surfaces and allows faster initial threading to speed installation
- UL Listed for use in plenum or air handling spaces per NEC except PLT.6SM and PLT5H/6H/8H/13H

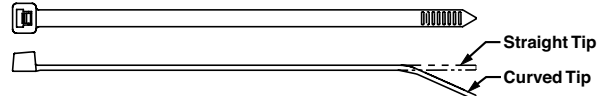

Part Number	Length In. (mm)	Width In. (mm)	Max Bundle Diameter In. (mm)	Material	Color	Resistance Properties	AH-2 Plenum Rated	UL 94 Flammability Rating	UL 62275 Type	Pkg. Qty.	Installation Tools
Miniature Cross Section											
PLT.7M-M0	3.1 (79)	0.090 (2.3)	0.68 (17)	Weather Resistant Nylon 6.6	Black	UV Resistant	✓	V-2	2, 21	1000	GTS-E, GS2B-E, PTS, PPTS, STS2
PLT1M-C0	3.9 (99)	0.098 (2.5)	0.87 (22)							100	
BEST SELLER PLT1M-M0	3.9 (99)	0.098 (2.5)	0.87 (22)							1000	
PLT1.5M-C0	5.6 (142)	0.098 (2.5)	1.25 (32)							100	
PLT2M-C0	8.0 (203)	0.098 (2.5)	2.00 (51)							100	
BEST SELLER PLT2M-M0	8.0 (203)	0.098 (2.5)	2.00 (51)							1000	
Intermediate Cross Section											
PLT1.5I-C0	5.6 (142)	0.142 (3.6)	1.38 (35)	Weather Resistant Nylon 6.6	Black	UV Resistant	✓	V-2	2, 21	100	GTS-E, GS2B-E, PTS, PPTS, STS2
BEST SELLER PLT1.5I-M0	5.6 (142)	0.142 (3.6)	1.38 (35)							1000	
PLT2I-C0	8.0 (203)	0.142 (3.6)	2.00 (51)							100	
BEST SELLER PLT2I-M0	8.0 (203)	0.142 (3.6)	2.00 (51)							1000	
PLT3I-C0	11.4 (290)	0.145 (3.7)	3.00 (76)							100	
BEST SELLER PLT3I-M0	11.4 (290)	0.145 (3.7)	3.00 (76)							1000	
PLT4I-C0	14.5 (368)	0.145 (3.7)	4.00 (102)							100	

(continued on next page)

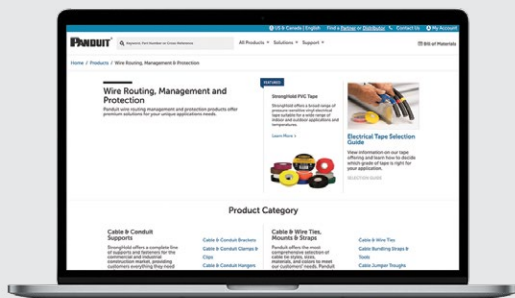

Like what you see? Want more?

Visit www.panduit.com for the full offering of Panduit products

www.panduit.com



Panduit Locking Tie Cable Ties – Weather Resistant Nylon 6.6 (continued)

Part Number	Length In. (mm)	Width In. (mm)	Max Bundle Diameter In. (mm)	Material	Color	Resistance Properties	AH-2 Plenum Rated	UL 94 Flammability Rating	UL 62275 Type	Pkg. Qty.	Installation Tools
Standard Cross Section											
BEST SELLER PLT2S-C0	7.4 (188)	0.190 (4.8)	1.88 (48)	Weather Resistant Nylon 6.6	Black	UV Resistant	✓	V-2	2, 21, 2S, 21S	100	GTS-E, GS2B-E, GTH-E, GS4H-E, PTS, PPTS, PTH, STS2, STH2
PLT2.5S-C0	9.8 (249)	0.190 (4.8)	2.50 (64)								
BEST SELLER PLT2S-M0	7.4 (188)	0.190 (4.8)	1.88 (48)							1000	
BEST SELLER PLT3S-C0	11.5 (292)	0.190 (4.8)	3.00 (76)							100	
BEST SELLER PLT3S-M0	11.5 (292)	0.190 (4.8)	3.00 (76)							1000	
BEST SELLER PLT4S-C0	14.5 (368)	0.190 (4.8)	4.00 (102)							100	
BEST SELLER PLT4S-M0	14.5 (368)	0.190 (4.8)	4.00 (102)							1000	
PLT5S-C0	17.5 (445)	0.190 (4.8)	5.00 (127)							100	

Light-Heavy Cross Section											
PLT6LH-L0	21.9 (556)	0.300 (7.6)	6.00 (152)	Weather Resistant Nylon 6.6	Black	UV Resistant	✓	V-2	2, 21	50	GTH-E, GS4H-E, GS4EH-E, PTH, STH2, ST3EH
PLT7LH-L0	24.7 (627)	0.300 (7.6)	7.00 (176)								
PLT9LH-L0	30.5 (775)	0.300 (7.6)	9.00 (229)								

Heavy Cross Section (Straight Tip)												
PLT5H-L0	17.7 (450)	0.350 (8.9)	5.00 (127)	Weather Resistant Nylon 6.6	Black	UV Resistant	-	V-2	1, 11	50	GTH-E, GS4H-E, GS4EH-E, PTH, STH2, ST3EH	
PLT6H-L0	20.9 (530)	0.350 (8.9)	6.00 (152)									
PLT8H-L0	30.6 (779)	0.350 (8.9)	9.00 (229)							✓		
PLT13H-Q0	43.3 (1100)	0.350 (8.9)	13.00 (330)							-		25
PLT2H-L0	8.1 (206)	0.300 (7.6)	2.00 (51)							✓		50
PLT3H-L0	11.4 (290)	0.300 (7.6)	3.00 (76)									
BEST SELLER PLT4H-L0	14.5 (368)	0.300 (7.6)	4.00 (102)									
BEST SELLER PLT4H-TL0	14.5 (368)	0.300 (7.6)	4.00 (102)									
PLT4H-TL0/147	14.5 (368)	0.300 (7.6)	4.11 (104.5)									



Panduit Locking Tie Lashing Ties – Weather Resistant Nylon 6.6

- Greater resistance to damage caused by ultraviolet light – indoor or outdoor use
- Typically used for heavy duty applications
- Among the strongest Panduit Locking Cable Ties available
- Can be used with MCEH mounting clip



Lashing Tie



No Buckle Design

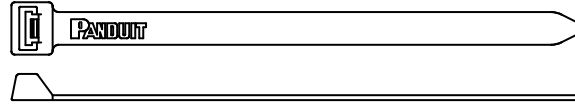
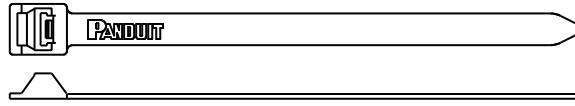

Part Number	Length In. (mm)	Width In. (mm)	Max Bundle Diameter In. (mm)	Material	Color	Resistance Properties	AH-2 Plenum Rated	UL 94 Flammability Rating	UL 62275 Type	Pkg. Qty.	Installation Tools
Extra-Heavy Cross Section											
PLT5EH-Q0	20.1 (511)	0.500 (12.7)	5.00 (127)	Weather Resistant Nylon 6.6	Black	UV Resistant	—	V-2	1, 11	25	GS4EH-E, ST3EH
PLT6EH-Q0	22.2 (564)	0.500 (12.7)	6.00 (152)								
Extra-Heavy Cross Section (No Buckle Design)											
PLT5EH-NB-C0	19.8 (503)	0.500 (12.7)	5.00 (127)	Weather Resistant Nylon 6.6	Black	UV Resistant	—	V-2	1, 11	100	GS4EH-E, ST3EH

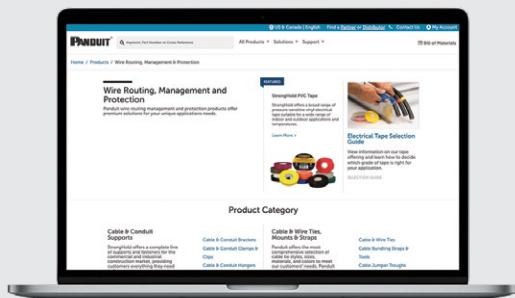

Like what you see? Want more?

Visit www.panduit.com for the full offering of Panduit products

www.panduit.com



Panduit Locking Tie Cable Ties – Heat Stabilized Nylon 6.6

- For high temperature applications up to 239°F (115°C) – indoor use
- One-piece construction for consistent performance and reliability
- Among the lowest threading force of any one-piece cable tie in the industry
- Curved tip is easy to pick up from flat surfaces and allows faster initial threading to speed installation

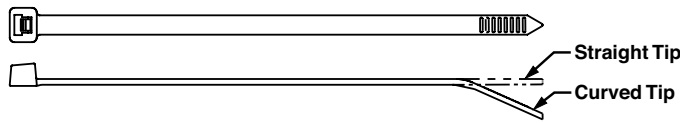

Part Number	Length In. (mm)	Width In. (mm)	Max Bundle Diameter In. (mm)	Material	Color	Resistance Properties	AH-2 Plenum Rated	UL 94 Flammability Rating	UL 62275 Type	Pkg. Qty.	Installation Tools
-------------	-----------------	----------------	------------------------------	----------	-------	-----------------------	-------------------	---------------------------	---------------	-----------	--------------------

Subminiature Cross Section

PLT.6SM-M30	2.8 (71)	0.070 (1.8)	.60 (15)	Heat Stabilized Nylon 6.6	Black	Heat Resistant	—	V-2	1, 11	1000	GTS-E, PTS
--------------------	----------	-------------	----------	---------------------------	-------	----------------	---	-----	-------	------	------------

Miniature Cross Section

BEST SELLER

PLT1M-M30	3.9 (99)	.098 (2.5)	0.87 (22)	Heat Stabilized Nylon 6.6	Black	Heat Resistant	—	V-2	2, 21	1000	GTS-E, GS2B-E, PTS, PPTS, STS2
PLT1.5M-M30	5.6 (142)	0.098 (2.5)	1.25 (32)								
PLT2M-M30	8.0 (203)	0.098 (2.5)	2.00 (51)								

Intermediate Cross Section

PLT2I-C30	8.0 (203)	0.142 (3.6)	2.00 (51)	Heat Stabilized Nylon 6.6	Black	Heat Resistant	—	V-2	2, 21	100	GTS-E, GS2B-E, PTS, PPTS, STS2
PLT3I-M30	11.4 (290)	0.145 (3.7)	3.00 (76)							1000	
PLT4I-M30	14.5 (368)	0.145 (3.7)	4.00 (102)							1000	

Standard Cross Section

PLT1S-M30	4.8 (122)	0.190 (4.8)	1.00 (25)	Heat Stabilized Nylon 6.6	Black	Heat Resistant	—	V-2	2, 21	1000	GTS-E, GS2B-E, GTH-E, GS4H-E, PTS, PPTS, PTH, STS2, STH2
PLT5S-M30	17.5 (445)	0.190 (4.8)	5.00 (127)								

Light-Heavy Cross Section (Straight Tip)

PLT2H-TL30	8.1 (206)	0.300 (7.6)	2.00 (51)	Heat Stabilized Nylon 6.6	Black	Heat Resistant	—	V-2	2, 21	250	GTH-E, GS4H-E, GS4EH-E, PTH, STH2, ST3EH
PLT3H-TL30	11.4 (290)	0.300 (7.6)	3.00 (76)								
PLT4H-TL30	14.5 (368)	0.300 (7.6)	4.00 (102)								
PLT7LH-C30	24.7 (627)	0.300 (7.6)	7.00 (178)								
PLT9LH-C30	30.5 (775)	0.300 (7.6)	9.00 (229)								

Heavy Cross Section (Straight Tip)

PLT5H-C30	17.7 (450)	0.350 (8.9)	5.00 (127)	Heat Stabilized Nylon 6.6	Black	Heat Resistant	—	V-2	1, 11	100	GTH-E, GS4H-E, GS4EH-E, PTH, STH2, ST3EH
PLT6H-C30	20.9 (530)	0.350 (8.9)	6.00 (152)								
PLT8H-C30	30.6 (779)	0.350 (8.9)	9.00 (229)								

www.panduit.com



Panduit Locking Tie Cable Ties – Heat Stabilized Weather Resistant Nylon 6.6

- Greater resistance to damage caused by ultraviolet light and for high temperature applications up to 239°F (115°C) – indoor or outdoor use
- One-piece construction for consistent performance and reliability
- Among the lowest threading force of any one-piece cable tie in the industry
- Curved tip is easy to pick up from flat surfaces and allows faster initial threading to speed installation

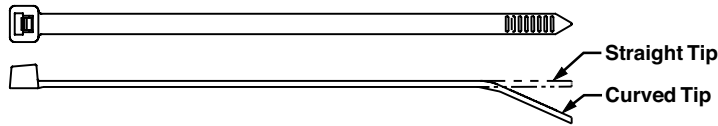

Part Number	Length In. (mm)	Width In. (mm)	Max Bundle Diameter In. (mm)	Material	Color	Resistance Properties	AH-2 Plenum Rated	UL 94 Flammability Rating	UL 62275 Type	Pkg. Qty.	Installation Tools
Miniature Cross Section											
PLT1M-M300	3.9 (99)	0.098 (2.5)	0.87 (22)	Heat Stabilized Weather Resistant Nylon 6.6	Black	Heat and UV Resistant	✓	V-2	2	1000	GTS-E, GS2B-E, PTS, PPTS, STS2
Intermediate Cross Section											
PLT2I-M300	8.0 (203)	0.142 (3.6)	2.00 (51)	Heat Stabilized Weather Resistant Nylon 6.6	Black	Heat and UV Resistant	✓	V-2	2	1000	GTS-E, GS2B-E, PTS, PPTS, STS2
Heavy Cross Section (Straight Tip)											
PLT2S-M300	7.4 (188)	0.190 (4.8)	1.88 (48)	Heat Stabilized Weather Resistant Nylon 6.6	Black	Heat and UV Resistant	✓	V-2	2	1000	GTS-E, GS2B-E, GTH-E, GS4H-E, PTS, PTH, PPTS, PTS2 STH2
PLT4S-M300	14.5 (368)	0.190 (4.8)	4.00 (102)								
Light-Heavy Cross Section (Straight Tip)											
PLT4H-TL300	14.5 (368)	0.300 (7.6)	4.00 (102)	Heat Stabilized Weather Resistant Nylon 6.6	Black	Heat and UV Resistant	✓	V-2	2	1000	GTH-E, GS4H-E, GS4EH-E, PTH, STH2 ST3EH

UL US C SP US Panduit Locking Tie Cable Ties – Flame Retardant Nylon 6.6

- Flammability rating of UL 94V-0 – indoor use
- One-piece construction for consistent performance and reliability
- Among the lowest threading force of any one-piece cable tie in the industry
- Curved tip is easy to pick up from flat surfaces and allows faster initial threading to speed installation

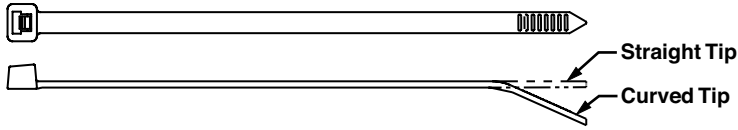

Part Number	Length In. (mm)	Width In. (mm)	Max Bundle Diameter In. (mm)	Material	Color	Resistance Properties	AH-2 Plenum Rated	UL 94 Flammability Rating	UL 62275 Type	Pkg. Qty.	Installation Tools
-------------	-----------------	----------------	------------------------------	----------	-------	-----------------------	-------------------	---------------------------	---------------	-----------	--------------------

Miniature Cross Section

PLT1M-M69	4.0 (102)	0.098 (2.5)	0.87 (22)	Flame Retardant Nylon 6.6	Ivory	Flame Retardant	—	V-0	1, 11	1000	GTS-E, GS2B-E, PTS, PPTS, STS2
-----------	-----------	-------------	-----------	---------------------------	-------	-----------------	---	-----	-------	------	--------------------------------

Standard Cross Section

PLT4S-M69	14.5 (368)	0.190 (4.8)	4.00 (102)	Flame Retardant Nylon 6.6	Ivory	Flame Retardant	—	V-0	1, 11	1000	GTS-E, GS2B-E, GTH-E, GS4H-E, PTS, PTH, PPTS, STS2, STH2
-----------	------------	-------------	------------	---------------------------	-------	-----------------	---	-----	-------	------	--

Light-Heavy Cross Section (Straight Tip)

PLT4H-TL69	14.6 (371)	0.300 (7.6)	4.00 (102)	Flame Retardant Nylon 6.6	Ivory	Flame Retardant	—	V-0	1, 11	250	GTH-E, GS4H-E, GS4EH-E, PTH, STH2, ST3EH
------------	------------	-------------	------------	---------------------------	-------	-----------------	---	-----	-------	-----	--

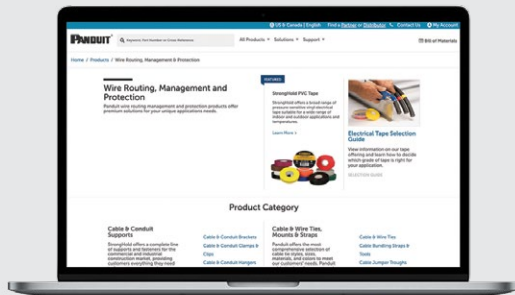

Like what you see? Want more?

Visit www.panduit.com for the full offering of Panduit products

www.panduit.com

Panduit Locking Tie Cable Ties – Weather Resistant Nylon 12

- For high moisture, corrosive (zinc chloride and dilute acids), and low temperature indoor or outdoor applications
- Cable tie of choice for making attachments to galvanized surfaces
- One-piece construction for consistent performance and reliability
- Among the lowest threading force of any one-piece cable tie in the industry
- Curved tip is easy to pick up from flat surfaces and allows faster initial threading to speed installation

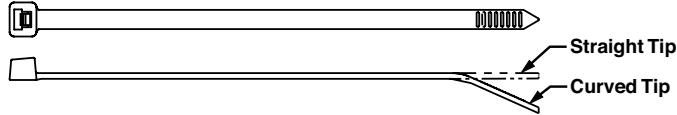

Part Number	Length In. (mm)	Width In. (mm)	Max Bundle Diameter In. (mm)	Material	Color	Resistance Properties	AH-2 Plenum Rated	UL 94 Flammability Rating	UL 62275 Type	Pkg. Qty.	Installation Tools
-------------	-----------------	----------------	------------------------------	----------	-------	-----------------------	-------------------	---------------------------	---------------	-----------	--------------------

Intermediate Cross Section

PLT1.5I-M120	5.6 (142)	0.142 (3.6)	1.38 (35)	Weather Resistant Nylon 12	Black	UV Resistant	—	HB	—	1000	GTS-E, GS2B-E, PTS, PPTS, STS2
--------------	-----------	-------------	-----------	----------------------------	-------	--------------	---	----	---	------	--------------------------------

Standard Cross Section

PLT2S-M120	7.4 (188)	0.190 (4.8)	1.88 (48)	Weather Resistant Nylon 12	Black	UV Resistant	✓	HB	—	1000	GTS-E, GS2B-E, GTH-E, GS4H-E, PTS, PTH, PPTS, STS2, STH2
PLT4S-M120	14.5 (368)	0.190 (4.8)	4.00 (102)				—				

Light-Heavy Cross Section (Straight Tip)

PLT4H-TL120	14.5 (368)	0.300 (7.6)	4.00 (102)	Weather Resistant Nylon 12	Black	UV Resistant	—	HB	—	250	GTH-E, GS4H-E, GS4EH-E, PTH, STH2, ST3EH
PLT8LH-C120	27.6 (701)	0.300 (7.6)	8.00 (203)							100	

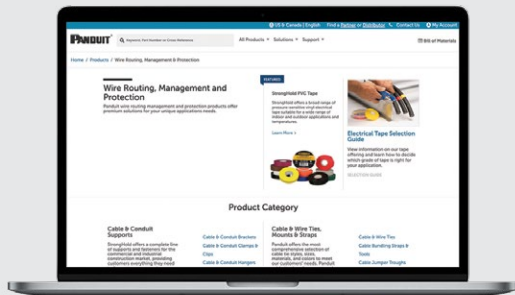

**Like what you see?
Want more?**

Visit www.panduit.com for the full offering of Panduit products

www.panduit.com

Panduit Locking Tie Cable Ties – Polypropylene – Distinctive Green Color

- For chemical resistance where high loop tensile strength is not required especially in the presence of hydrochloric acid, salts, and bases
- For indoor use
- One-piece construction for consistent performance and reliability
- Among the lowest threading force of any one-piece cable tie in the industry
- Curved tip is easy to pick up from flat surfaces and allows faster initial threading to speed installation

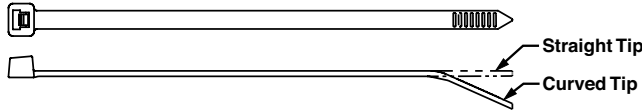

Standard Cross Section

Part Number	Length In. (mm)	Width In. (mm)	Max Bundle Diameter In. (mm)	Material	Color	Resistance Properties	AH-2 Plenum Rated	UL 94 Flammability Rating	UL 62275 Type	Pkg. Qty.	Installation Tools
PLT2S-M109	7.4 (188)	0.190 (4.8)	1.88 (48)	Polypropylene	Green	Chemical Resistant	—	HB	—	1000	GTS-E, GS2B-E, GTH-E, GS4H-E, PTS, PTH, PPTS, STS2, STH2
PLT3S-M109	11.5 (292)	0.190 (4.8)	3.00 (76)								
PLT4S-M109	14.5 (368)	0.190 (4.8)	4.00 (102)								

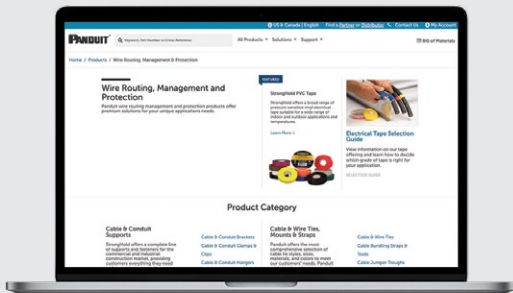

**Like what you see?
Want more?**

Visit www.panduit.com for the full offering of Panduit products

Panduit Locking Tie Cable Ties – Weather Resistant Polypropylene

- For chemical resistance where high loop tensile strength is not required especially in the presence of hydrochloric acid, salts, and bases
- Greater resistance to damage caused by ultraviolet light – indoor or outdoor use
- One-piece construction for consistent performance and reliability
- Among the lowest threading force of any one-piece cable tie in the industry
- Curved tip is easy to pick up from flat surfaces and allows faster initial threading to speed installation

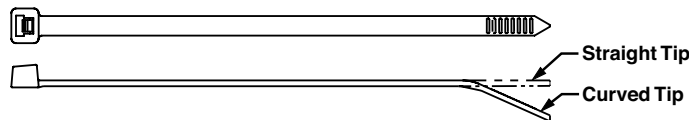

Part Number	Length In. (mm)	Width In. (mm)	Max Bundle Diameter In. (mm)	Material	Color	Resistance Properties	AH-2 Plenum Rated	UL 94 Flammability Rating	UL 62275 Type	Pkg. Qty.	Installation Tools
Miniature Cross Section											
PLT1M-M100	3.9 (99)	0.098 (2.5)	0.87 (22)	Weather Resistant Polypropylene	Black	Chemical and UV Resistant	—	HB	—	1000	GTS-E, GS2B-E, PTS, PPTS, STS2
Intermediate Cross Section											
PLT1.5I-M100	5.6 (142)	0.142 (3.6)	1.38 (35)	Weather Resistant Polypropylene	Black	Chemical and UV Resistant	—	HB	—	1000	GTS-E, GS2B-E, PTS, PPTS, STS2
Standard Cross Section											
PLT2S-M100	7.4 (188)	0.190 (4.8)	1.88 (48)	Weather Resistant Polypropylene	Black	Chemical and UV Resistant	—	HB	—	1000	GTS-E, GS2B-E, GTH-E, GS4H-E, PTS, PTH, PPTS, STS2, STH2
PLT3S-M100	11.5 (292)	0.190 (4.8)	3.00 (76)								
PLT4S-M100	14.5 (368)	0.190 (4.8)	4.00 (102)								
Light-Heavy Cross Section (Straight Tip)											
PLT2H-TL100	8.1 (206)	0.300 (7.6)	2.00 (51)	Weather Resistant Polypropylene	Black	Chemical and UV Resistant	—	HB	—	250	GTH-E, GS4H-E, GS4EH-E, PTH, STH2, ST3EH
PLT3H-TL100	11.4 (290)	0.300 (7.6)	3.00 (76)								
PLT4H-TL100	14.5 (368)	0.300 (7.6)	4.00 (102)								



Panduit Locking Tie Cable Ties – HALAR* – Distinctive Maroon Color

- UL Listed for use in plenum or air handling spaces per NEC, Section 300-22 (C) and (D)
- Low smoke density and excellent flammability rating of UL 94V-0
- Commonly accepted solution for bundling qualified cable without conduit in air handling space applications
- Greater resistance to damage caused by ultraviolet light – indoor or outdoor use
- One-piece construction for consistent performance and reliability
- Among the lowest threading force of any one-piece cable tie in the industry
- Curved tip is easy to pick up from flat surfaces and allows faster initial threading to speed installation
- Provides primary support for a flexible conduit, flexible tubing, or cable in accordance with the relevant national installation code

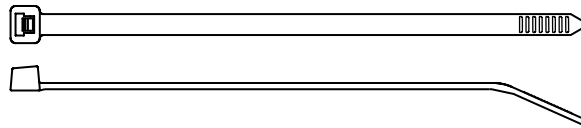

Part Number	Length In. (mm)	Width In. (mm)	Max Bundle Diameter In. (mm)	Material	Color	Resistance Properties	AH-2 Plenum Rated	UL 94 Flammability Rating	UL 62275 Type	Pkg. Qty.	Installation Tools
-------------	-----------------	----------------	------------------------------	----------	-------	-----------------------	-------------------	---------------------------	---------------	-----------	--------------------

Miniature Cross Section

PLT1M-C702Y	4.0 (102)	0.098 (2.5)	0.87 (22)	HALAR	Maroon	Heat and UV Resistant	✓	V-0	2, 21	100	GTS-E, GS2B-E, PTS, PPTS, STS2
-------------	-----------	-------------	-----------	-------	--------	-----------------------	---	-----	-------	-----	--------------------------------

Standard Cross Section

PLT2S-C702Y	7.4 (188)	0.190 (4.8)	1.88 (48)	HALAR	Maroon	Heat and UV Resistant	✓	V-0	2, 21, 2S, 21S	100	GTS-E, GS2B-E, GTH-E, GS4H-E, PTS, PTH, PPTS, STS2, STH2
PLT3S-C702Y	11.6 (295)	0.190 (4.8)	3.00 (76)								

*HALAR is a registered trademark of Solvay Solexis

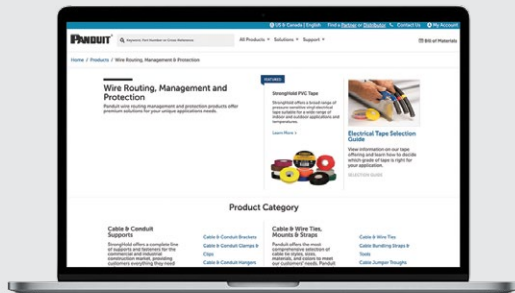

Like what you see? Want more?

Visit www.panduit.com for the full offering of Panduit products

www.panduit.com

< PREVIOUS PAGE | TABLE OF CONTENTS | NEXT PAGE >



Panduit Locking Tie Cable Ties – TEFZEL** – Distinctive Aqua Blue Color

- Ideal for applications requiring resistance to environmental stresses such as chemical attack, gamma radiation, ultraviolet radiation and extreme high and low temperatures
- Ideal for use in nuclear power facilities and chemical processing plants and meets the requirements of IEEE 383
- Low smoke density and excellent flammability rating of UL 94V-0
- One-piece construction for consistent performance and reliability
- Among the lowest threading force of any one-piece cable tie in the industry
- Curved tip is easy to pick up from flat surfaces and allows faster initial threading to speed installation
- For indoor or outdoor use

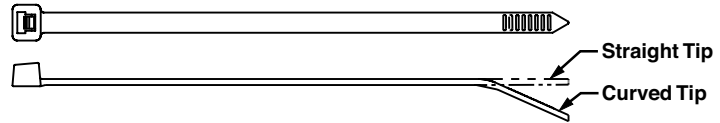

Part Number	Length In. (mm)	Width In. (mm)	Max Bundle Diameter In. (mm)	Material	Color	Resistance Properties	AH-2 Plenum Rated	UL 94 Flammability Rating	UL 62275 Type	Pkg. Qty.	Installation Tools
-------------	-----------------	----------------	------------------------------	----------	-------	-----------------------	-------------------	---------------------------	---------------	-----------	--------------------

Miniature Cross Section

PLT1M-C76	4.0 (102)	0.098 (2.5)	0.87 (22)	TEFZEL	Aqua	Chemical, Radiation, UV and High Heat Resistant	—	V-0	1, 11	100	GTS-E, GS2B-E, PTS, PPTS, STS2
PLT1M-M76	4.0 (102)	0.098 (2.5)	0.87 (22)							1000	

BEST SELLER

Intermediate Cross Section

PLT2I-C76	8.0 (203)	0.135 (3.4)	2.00 (51)	TEFZEL	Aqua	Chemical, Radiation, UV and High Heat Resistant	—	V-0	1, 11	100	GTS-E, GS2B-E, PTS, PPTS, STS2
PLT2I-M76	8.0 (203)	0.135 (3.4)	2.00 (51)							1000	

BEST SELLER

Standard Cross Section

PLT2S-C76	7.4 (188)	0.190 (4.8)	1.88 (48)	TEFZEL	Aqua	Chemical, Radiation, UV and High Heat Resistant	—	V-0	1, 11	100	GTS-E, GS2B-E, GTH-E, GS4H-E, PTS, PTH, PPTS, STS2, STH2
PLT3S-C76	11.6 (295)	0.190 (4.8)	3.00 (76)								
PLT4S-C76	14.6 (371)	0.190 (4.8)	4.00 (102)								

Light-Heavy Cross Section (Straight Tip)

PLT3H-L76	11.5 (292)	0.300 (7.6)	3.00 (78)	TEFZEL	Aqua	Chemical, Radiation, UV and High Heat Resistant	—	V-0	1, 11	50	GTH-E, GS4H-E, GS4EH-E, PTH, STH2, ST3EH
PLT4H-L76	14.6 (371)	0.300 (7.6)	4.00 (102)							250	
PLT4H-TL76	14.6 (371)	0.300 (7.6)	4.00 (102)							250	

BEST SELLER

**TEFZEL is a registered trademark of The Chemours Company.

UL LISTED Cable Tie Mounts – TEFZEL**

- Flammability rating of UL 94V-0 – indoor use
- Unique cradle design provides maximum stability for the cable bundle
- Low profile design keeps bundle close to mounting surface

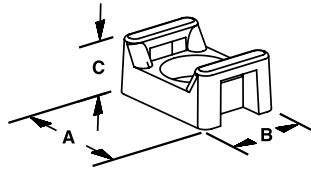
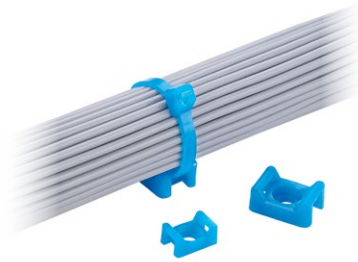

Part Number	Used with Cable Ties*	Length A		Width B		Height C		Counterbore Diameter		Mounting Method	Std. Pkg. Qty.	Std. Ctn. Qty.
		In.	mm	In.	mm	In.	mm	In.	mm			
TM2S8-C76	M, I, S	0.63	16.0	0.43	10.8	0.28	7.0	0.30	7.6	#8 (M4) screw	100	500
TM3S8-C76	S, LH	0.86	21.7	0.62	15.5	0.38	9.5	0.37	9.4	#8 (M4) screw		
TM3S10-C76	S, LH	0.86	21.7	0.62	15.8	0.38	9.5	0.37	9.4	#10 (M5) screw		

*Cable tie cross section sizes: M = Miniature, I = Intermediate, S = Standard, LH = Light-Heavy.
 **Tefzel is a registered trademark of The Chemours Company.

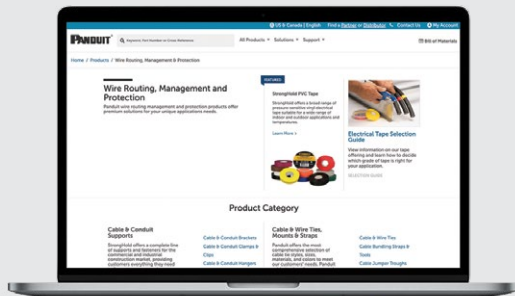

Like what you see? Want more?

Visit www.panduit.com for the full offering of Panduit products

Panduit Locking Tie Cable Ties – PEEK (Polyetheretherketone)

- Ideal for harsh environments where a cable tie material is required to hold up to chemical or radiation exposure
- Non-conductive material that is excellent for high temperature applications up to 500°F (260°C)
- High strength properties over a wide range of temperatures
- Flammability rating of UL 94V-0 with low smoke and toxicity; halogen-free
- PEEK material meets MIL specification MIL-P-46183, and is approved for use by the Department of Defense
- One-piece construction for consistent performance and reliability
- Among the lowest threading force of any one-piece cable tie in the industry

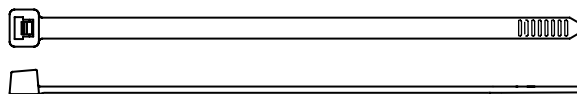

Part Number	Length In. (mm)	Width In. (mm)	Max Bundle Diameter In. (mm)	Material	Color	Resistance Properties	AH-2 Plenum Rated	UL 94 Flammability Rating	UL 62275 Type	Pkg. Qty.	Installation Tools
-------------	--------------------	----------------------	---------------------------------------	----------	-------	--------------------------	-------------------------	---------------------------------	---------------------	--------------	-----------------------

Miniature Cross Section

PLT1M-C71	4.0 (102)	0.098 (2.5)	0.87 (22)	Polyether- etherketone	Translucent	Chemical, Radiation and High Heat Resistant	—	V-0	—	100	GTS-E, PTS
PLT1.5M-C71	5.9 (150)	0.098 (2.5)	0.87 (22)								

Standard Cross Section

PLT2S-C71	7.4 (188)	0.190 (4.8)	1.88 (48)	Polyether- etherketone	Translucent	Chemical, Radiation and High Heat Resistant	—	V-0	—	100	GTS-E, GS2B-E, GTH-E, GS4H-E, PTS, PTH, PPTS, STS2 STH2
------------------	--------------	----------------	--------------	---------------------------	-------------	---	---	-----	---	-----	---

Cable Tie Mount – PEEK (Polyetheretherketone)

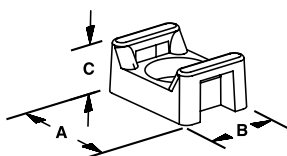

- Unique cradle design provides maximum stability for cable bundle
- Low profile design keeps bundle close to mounting surface where overhead space is limited

Part Number	Used with Cable Ties*	A Length In. (mm)	B Width In. (mm)	C Height In. (mm)	Counterbore Diameter In. (mm)	Mounting Method	Std. Pkg. Qty.	Std. Ctn. Qty.
TM2S8-C71	Minimum, Standard	0.636 (16.2)	0.427 (10.8)	0.278 (7.1)	0.335 (8.5)	#8 (M4) screw	100	500

Panduit Locking Tie Cable Ties – Metal Detectable Nylon 6.6 and Polypropylene

- Metal impregnated material allows identification by metal detector inspection equipment to help meet food, beverage, and pharmaceutical safety standards, to help reduce product contamination, loss, and recall
- Nylon material for general purpose maintenance and repair applications; ideal for use in control panels and overhead cable runs
- Polypropylene material provides excellent chemical resistance for use in processing and packaging areas where aggressive acid and alkaline chemicals are used to clean the equipment
- One-piece construction for consistent performance and reliability
- Among the lowest threading force of any one-piece cable tie in the industry
- Curved tip is easy to pick up from flat surfaces and allows faster initial threading to speed installation

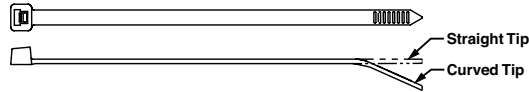

Part Number	Length In. (mm)	Width In. (mm)	Max Bundle Diameter In. (mm)	Material	Color	Resistance Properties	AH-2 Plenum Rated	UL 94 Flammability Rating	UL 62275 Type	Pkg. Qty.	Installation Tools
-------------	-----------------	----------------	------------------------------	----------	-------	-----------------------	-------------------	---------------------------	---------------	-----------	--------------------

Miniature Cross Section

PLT1M-C86	3.9 (100)	0.098 (2.5)	.87 (22)	Metal Impregnated Nylon 6.6	Light Blue	—	—	HB	—	100	GTS-E, GS2B-E, STS2
PLT1M-C186	3.9 (100)	0.098 (2.5)	.87 (22)	Metal Impregnated Polypropylene	Dark Blue	Chemical Resistant					

Intermediate Cross Section

PLT2I-C86	8.0 (203)	0.135 (3.4)	2.00 (51)	Metal Impregnated Nylon 6.6	Light Blue	—	—	HB	—	100	GTS-E, GS2B-E, STS2
PLT2I-C186	8.0 (203)	0.135 (3.4)	2.00 (51)	Metal Impregnated Polypropylene	Dark Blue	Chemical Resistant					

Standard Cross Section

PLT2S-C86	7.3 (186)	0.190 (4.8)	1.85 (47)	Metal Impregnated Nylon 6.6	Light Blue	—	—	HB	—	100	GTS-E, GS2B-E, GTH-E, GS4H-E, STS2, STH2
PLT2S-C186	7.3 (186)	0.190 (4.8)	1.85 (47)	Metal Impregnated Polypropylene	Dark Blue	Chemical Resistant					
PLT3S-C186	11.5 (291)	0.190 (4.8)	3.00 (76)	Metal Impregnated Polypropylene	Dark Blue	Chemical Resistant					
PLT4S-C86	14.4 (366)	0.190 (4.8)	4.00 (102)	Metal Impregnated Nylon 6.6	Light Blue	—					
PLT4S-C186	14.4 (366)	0.190 (4.8)	4.00 (102)	Metal Impregnated Polypropylene	Dark Blue	Chemical Resistant					

Light-Heavy Cross Section (Straight Tip)

PLT3H-L86	11.1 (282)	0.300 (7.6)	3.00 (76)	Metal Impregnated Nylon 6.6	Light Blue	—	—	HB	—	50	GTH-E, GS4H-E, STH2, ST3EH
PLT3H-L186	11.1 (282)	0.300 (7.6)	3.00 (76)	Metal Impregnated Polypropylene	Dark Blue	Chemical Resistant					
PLT4H-L86	14.4 (366)	0.300 (7.6)	4.00 (102)	Metal Impregnated Nylon 6.6	Light Blue	—					
PLT4H-L186	14.4 (366)	0.300 (7.6)	4.00 (102)	Metal Impregnated Polypropylene	Dark Blue	Chemical Resistant					

(continued on next page)

Panduit Locking Tie Cable Ties – Metal Detectable Nylon 6.6 and Polypropylene (continued)

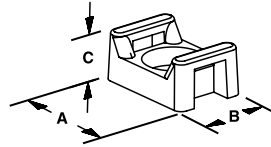

Part Number	Material	Used with Cable Ties*	A Length In. (mm)	B Width In. (mm)	C Height In. (mm)	Counterbore Diameter In. (mm)	Mounting Method	Std. Pkg. Qty.	Std. Ctn. Qty.
Cable Tie Mounts									
TM2S8-C86	Nylon 6.6	Min., Int., Std.	0.630 (16.0)	0.422 (10.7)	0.275 (7.0)	0.325 (8.3)	#8 (M4) screw	100	500
TM3S8-C86	Nylon 6.6	Std., Lt. Hvy.	0.867 (22.0)	0.614 (15.6)	0.373 (9.5)	0.325 (8.3)	#8 (M4) screw		
TM3S10-C86							#10 (M5) screw		
TM2S8-C186	Polypropylene	Min., Int., Std.	0.630 (16.0)	0.422 (10.7)	0.275 (7.0)	0.325 (8.3)	#8 (M4) screw		
TM3S8-C186	Polypropylene	Std., Lt. Hvy.	0.867 (22.0)	0.614 (15.6)	0.373 (9.5)	0.325 (8.3)	#8 (M4) screw		
TM3S10-C186							#10 (M5) screw		



Panduit Locking Tie Releasable Cable Ties – Nylon 6.6

- For indoor use
- Extended release tab permits easy release and re-use where changes are anticipated during development, production, or servicing in the field
- One-piece construction for consistent performance and reliability
- Curved tip is easy to pick up from flat surfaces and allows faster initial threading to speed installation
- UL Listed for use in plenum or air handling spaces per NEC except PRT2H/3H/4H

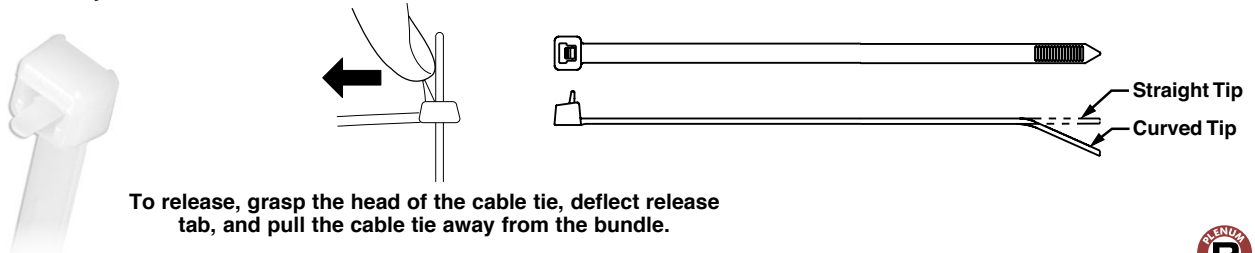

To release, grasp the head of the cable tie, deflect release tab, and pull the cable tie away from the bundle.



Standard Cross Section

Part Number	Length In. (mm)	Width In. (mm)	Max Bundle Diameter In. (mm)	Material	Color	Resistance Properties	AH-2 Plenum Rated	UL 94 Flammability Rating	UL 62275 Type	Pkg. Qty.	Installation Tools
PRT4S-C	14.5 (368)	0.190 (4.8)	4.00 (102)	Nylon 6.6	Natural	—	✓	V2	2, 21, 2S, 21S	100	Hand install only

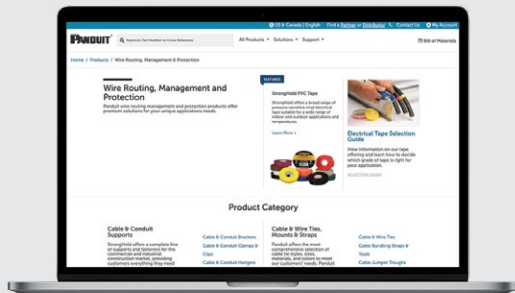

Like what you see? Want more?

Visit www.panduit.com for the full offering of Panduit products

www.panduit.com



Panduit Locking Tie Releasable Lashing Ties – Weather Resistant and Heat Stabilized Nylon 6.6

- Weather resistant material has greater resistance to damage caused by ultraviolet light – indoor or outdoor use
- Heat stabilized material for high temperature applications up to 239°F (115°C) – indoor use
- Release tab permits easy release and re-use where changes are anticipated during development, production, or servicing in the field
- Typically used for heavy duty applications
- Among the strongest Panduit Locking Tie Cable Tie available
- Can be used with MCEH mounting clip

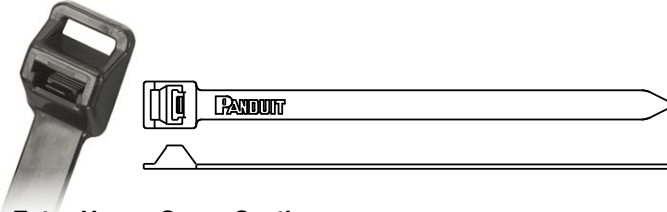

Extra-Heavy Cross Section

Part Number	Length In. (mm)	Width In. (mm)	Max Bundle Diameter In. (mm)	Material	Color	Resistance Properties	AH-2 Plenum Rated	UL 94 Flammability Rating	UL 62275 Type	Pkg. Qty.	Installation Tools		
PRT5EH-Q0	20.1 (511)	0.500 (12.7)	5.00 (127)	Weather Resistant Nylon 6.6	Black	UV Resistant	—	V-2	1, 11	25	Hand install only		
PRT5EH-C30*	20.1 (511)	0.500 (12.7)	5.00 (127)	Heat Stabilized Nylon 6.6		Heat Resistant			—	100			
BEST SELLER PRT5EH-C0	20.1 (511)	0.500 (12.7)	5.00 (127)	Weather Resistant Nylon 6.6		UV Resistant			—	V-2		1, 11	25
PRT6EH-Q0	22.2 (564)	0.500 (12.7)	6.00 (152)										
PRT8EH-Q0	28.3 (719)	0.500 (12.7)	8.00 (203)										

*PRT5EH-C30 not UL or CSA certified.

Panduit Locking Tie Releasable Lashing Ties – Weather Resistant Polypropylene

- For chemical resistance where high loop tensile strength is not required especially in the presence of hydrochloric acid, salts, and bases
- Greater resistance to damage caused by ultraviolet light – indoor or outdoor use
- Release tab permits easy release and re-use where changes are anticipated during development, production, or servicing in the field
- Typically used for heavy duty applications
- Can be used with MCEH mounting clip

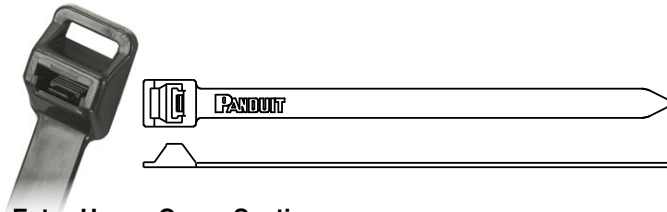

Extra-Heavy Cross Section

Part Number	Length In. (mm)	Width In. (mm)	Max Bundle Diameter In. (mm)	Material	Color	Resistance Properties	AH-2 Plenum Rated	UL 94 Flammability Rating	UL 62275 Type	Pkg. Qty.	Installation Tools
PRT2EH-C100	9.0 (229)	0.500 (12.7)	2.00 (51)	Weather Resistant Polypropylene	Black	Chemical and UV Resistant	—	HB	—	100	Hand install only
PRT5EH-C100	20.1 (511)	0.500 (12.7)	5.00 (127)								
PRT6EH-C100	22.2 (564)	0.500 (12.7)	6.00 (152)								
PRT8EH-C100	28.3 (719)	0.500 (12.7)	8.00 (203)								



Panduit Locking Tie Clamp Ties – Nylon 6.6

- For indoor use
- Used to secure a cable bundle to another surface such as a control panel, communication rack, wall or ceiling
- Design allows for bundling before or after screwing clamp in place
- One-piece construction for consistent performance and reliability
- Curved tip is easy to pick up from flat surfaces and allows faster initial threading to speed installation
- UL Listed for use in plenum or air handling spaces per NEC

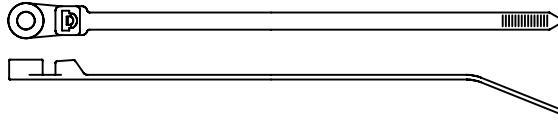

Part Number	Length In. (mm)	Width In. (mm)	Max Bundle Diameter In. (mm)	Material	Color	Resistance Properties	AH-2 Plenum Rated	UL 94 Flammability Rating	UL 62275 Type	Pkg. Qty.	Installation Tools
Miniature Cross Section											
PLC1M-S4-C	4.3 (109)	0.100 (2.5)	.75 (19)	Nylon 6.6	Natural	—	✓	V2	2, 21	100	GTS-E, GS2B-E
Standard Cross Section											
PLC2S-S10-C	7.9 (201)	0.190 (4.8)	1.84 (47)	Nylon 6.6	Natural	—	✓	V2	2, 21	100	GTS-E, GS2B-E, GTH-E, GS4H-E
PLC3S-S10-C	12.0 (305)	0.190 (4.8)	3.00 (76)								

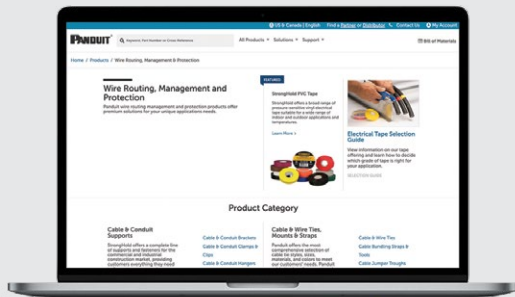

**Like what you see?
Want more?**

Visit www.panduit.com for the full offering of Panduit products



Panduit Locking Tie Clamp Ties – Weather Resistant and Heat Stabilized Nylon 6.6

- Weather resistant material has greater resistance to damage caused by ultraviolet light – indoor or outdoor use
- Heat stabilized material for high temperature applications up to 239°F (115°C) – indoor use
- Used to secure a cable bundle to another surface such as a control panel, communication rack, wall or ceiling
- Design allows for bundling before or after screwing clamp in place
- One-piece construction for consistent performance and reliability
- Curved tip is easy to pick up from flat surfaces and allows faster initial threading to speed installation

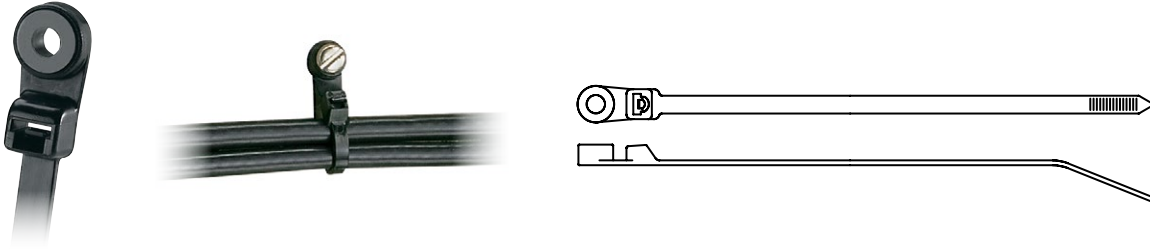

Part Number	Length In. (mm)	Width In. (mm)	Max Bundle Diameter In. (mm)	Material	Color	Resistance Properties	AH-2 Plenum Rated	UL 94 Flammability Rating	UL 62275 Type	Pkg. Qty.	Installation Tools
Standard Cross Section											
PLC2S-S6-C0	7.9 (201)	0.190 (4.8)	1.84 (47)	Weather Resistant Nylon 6.6	Black	UV Resistant	—	V2	1, 11	100	GTS-E, GS2B-E, GTH-E, GS4H-E
PLC2S-S10-C0	7.9 (201)	0.190 (4.8)	1.84 (47)								
PLC4S-S10-C0	15.0 (381)	0.190 (4.8)	4.00 (102)								
PLC2S-S10-M30	7.9 (201)	0.190 (4.8)	1.84 (47)	Heat Stabilized Nylon 6.6		Heat Resistant				1000	
Light-Heavy Cross Section											
PLC2H-S25-TL0	9.0 (229)	0.300 (7.6)	2.00 (51)	Weather Resistant Nylon 6.6	Black	UV Resistant	—	V2	1, 11	250	GTH-E, GS4H-E, GS4EH-E

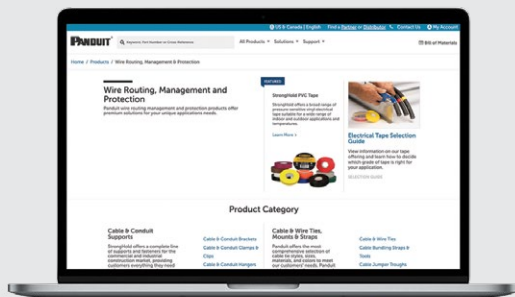

**Like what you see?
Want more?**

Visit www.panduit.com for the full offering of Panduit products

www.panduit.com

UL[®] US[®] CSF[®] Panduit Locking Tie Wing Push Mount Ties – Nylon 6.6

- For indoor use
- Cable tie, mount, and fastener in a single part
- Used to attach bundles to another surface such as a flat panel
- Anchor is easily pressed into a pre-formed hole and locks in place
- Wings provide constant tension for a stable, secure, and rattle-free installation
- Curved tip is easy to pick up from flat surfaces and allows faster initial threading to speed installation

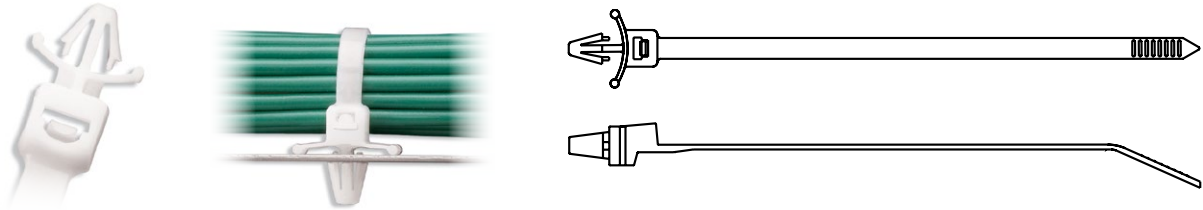

Standard Cross Section

Part Number	Length In. (mm)	Width In. (mm)	Max Bundle Diameter In. (mm)	Material	Color	Resistance Properties	AH-2 Plenum Rated	UL 94 Flammability Rating	UL 62275 Type	Pkg. Qty.	Installation Tools
PLWP1SB-D	5.2 (132)	0.190 (4.8)	1.00 (25)	Nylon 6.6	Natural	—	—	V2	1, 11	500	GTS-E, GS2B-E, GTH-E, GS4H-E, PTS, PTH, PPTS, STS2, STH2

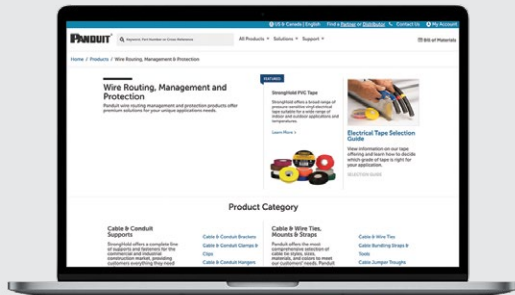

**Like what you see?
Want more?**

Visit www.panduit.com for the full offering of Panduit products

www.panduit.com

UL[®] US[®] CS[®] Panduit Locking Tie Wing Push Mount Ties – Heat Stabilized Nylon 6.6

- Weather resistant material has greater resistance to damage caused by ultraviolet light – indoor or outdoor use
- Heat stabilized material for high temperature applications up to 239°F (115°C) – indoor use
- Cable tie, mount, and fastener in a single part
- Used to attach bundles to another surface such as a flat panel
- Anchor is easily pressed into a pre-formed hole and locks in place
- Wings provide constant tension for a stable, secure, and rattle-free installation
- Curved tip is easy to pick up from flat surfaces and allows faster initial threading to speed installation

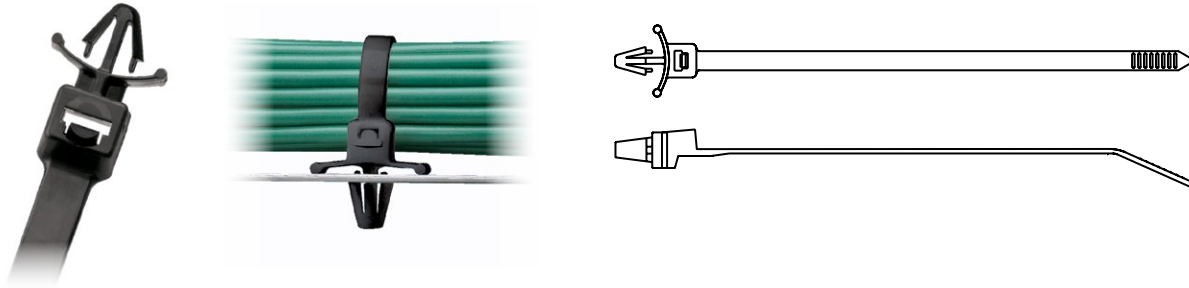

Miniature Cross Section

Part Number	Length In. (mm)	Width In. (mm)	Max Bundle Diameter In. (mm)	Material	Color	Resistance Properties	AH-2 Plenum Rated	UL 94 Flammability Rating	UL 62275 Type	Pkg. Qty.	Installation Tools
PLWP1M-D30	4.3 (109)	0.098 (2.5)	.87 (22)	Heat Stabilized Nylon 6.6	Black	Heat Resistant	—	V2	1, 11	500	GTS-E, GS2B-E, PTS, PPTS, STS2

Standard Cross Section

PLWP1S-D30	5.2 (132)	0.190 (4.8)	1.00 (25)	Heat Stabilized Nylon 6.6	Black	Heat Resistant	—	V2	1, 11	500	GTS-E, GS2B-E, GTH-E, GS4H-E, PTS, PTH, PPTS, STS2, STH2
------------	-----------	-------------	-----------	---------------------------	-------	----------------	---	----	-------	-----	--

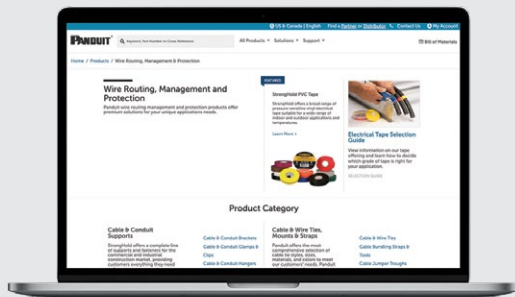

**Like what you see?
Want more?**

Visit www.panduit.com for the full offering of Panduit products

www.panduit.com

< PREVIOUS PAGE | TABLE OF CONTENTS | NEXT PAGE >

Panduit Locking Tie Releasable Wing Push Mount Ties

- Natural nylon material for indoor use
- Weather resistant material has greater resistance to damage caused by ultraviolet light – indoor or outdoor use

- Heat stabilized material for high temperature applications up to 239°F (115°C) – indoor use
- Cable tie, mount, and fastener in a single part
- Used to attach bundles to another surface such as a flat panel
- Anchor is easily pressed into a pre-formed hole and locks in place
- Wings provide constant tension for a stable, secure, and rattle-free installation
- Extended release tab permits easy release and re-use where changes are anticipated during development, production, or servicing in the field
- Curved tip is easy to pick up from flat surfaces and allows faster initial threading to speed installation



PRWP1.5S-D



PRWP1.5S-D0

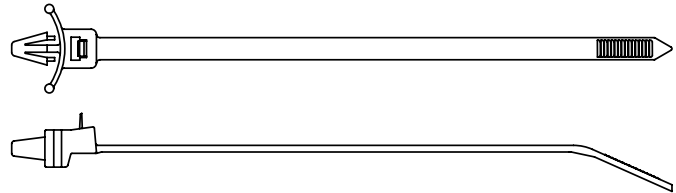

Standard Cross Section

Part Number	Length In. (mm)	Width In. (mm)	Max Bundle Diameter In. (mm)	Material	Color	Resistance Properties	AH-2 Plenum Rated	UL 94 Flammability Rating	UL 62275 Type	Pkg. Qty.	Installation Tools
PRWP1.5S-D	6.8 (173)	0.190 (4.8)	1.50 (38)	Nylon 6.6	Natural	—	—	—	1, 11	500	Hand install only
PRWP1.5S-D0	6.8 (173)	0.190 (4.8)	1.50 (38)	Weather Resistant Nylon 6.6	Black	UV Resistant	—	—			

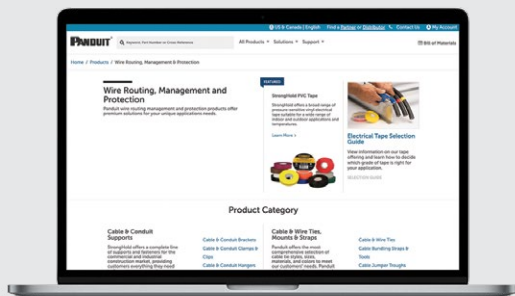

**Like what you see?
Want more?**

Visit www.panduit.com for the full offering of Panduit products

www.panduit.com

UL US C_{UL} SP_{US} Panduit Locking Tie Push Mount Ties

- Natural nylon material for indoor use
- Weather resistant material has greater resistance to damage caused by ultraviolet light – indoor or outdoor use
- Heat stabilized material for high temperature applications up to 239°F (115°C) – indoor use
- *Wingless* design allows tie to be used in confined spaces
- Cable tie, mount, and fastener in a single part
- Economical push mount ties are used to attach bundles to another surface such as a flat panel
- Anchor is easily pressed into a pre-formed hole and locks in place
- Curved tip is easy to pick up from flat surfaces and allows faster initial threading to speed installation

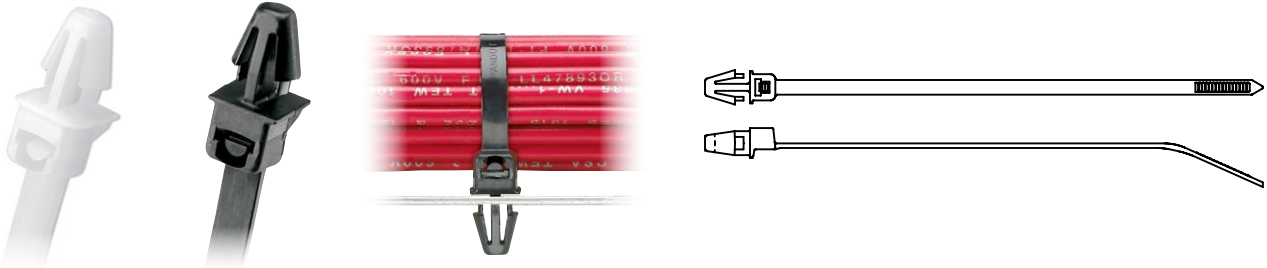

PLP1S-M PLP2S-M0
Standard Cross Section

Part Number	Length In. (mm)	Width In. (mm)	Max Bundle Diameter In. (mm)	Material	Color	Resistance Properties	AH-2 Plenum Rated	UL 94 Flammability Rating	UL 62275 Type	Pkg. Qty.	Installation Tools
PLP1S-M	5.3 (135)	0.180 (4.6)	1.00 (25)	Nylon 6.6	Natural	—	—	V2	1, 11	1000	GTS-E, GS2B-E, GTH-E, GS4H-E,
PLP2S-M0	7.9 (200)	0.180 (4.6)	1.75 (45)	Weather Resistant Nylon 6.6	Black	UV Resistant	—				PTS, PTH, PPTS, STS2 STH2

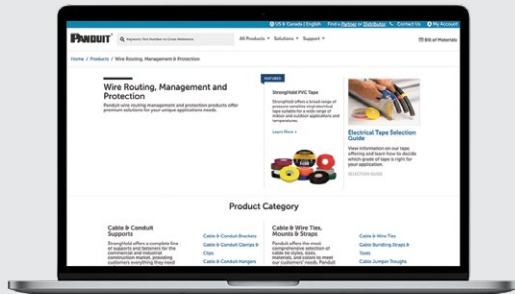

Like what you see? Want more?

Visit www.panduit.com for the full offering of Panduit products

www.panduit.com

UL US CS Panduit Locking Tie Marker and Flag Ties

- Natural nylon material for indoor use
- Weather resistant material has greater resistance to damage caused by ultraviolet light – indoor or outdoor use
- Used to fasten and identify bundles at the same time
- One-piece construction for consistent performance and reliability
- Can be marked with Panduit® marker pens or computer printable labels
- Custom imprinting with text, symbols, or trademarks available using Panduit Custom Hot Stamping Service
- Curved tip is easy to pick up from flat surfaces and allows faster initial threading to speed installation

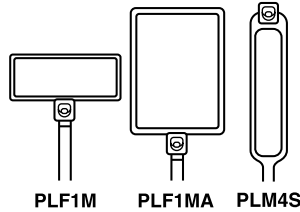
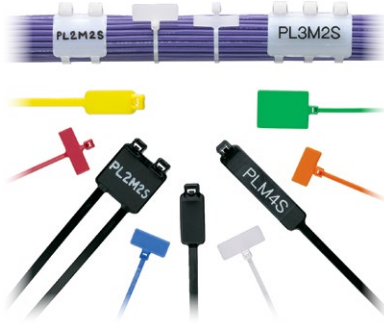

Part Number	Marker Type	Length		Width		Thickness		Marker Write-On Area		Max Bundle Diameter		Min. Loop Tensile Str.		Recommended Installation Tool	Std. Pkg. Qty.	Std. Ctn. Qty.
		In.	mm	In.	mm	In.	mm	In.	mm	In.	mm	lbs.	N			
Miniature Cross Section																
PLF1M-C	Flag	4.3	109	0.098	2.5	0.045	1.1	0.31 x 0.75	7.9 x 19.1	0.87	22	18	80	GTS-E, GS2B-E, PTS, PPTS, STS2	100	1000
PLF1MA-C		5.1	130					0.76 x 1.04	19.1 x 26.4							
Standard Cross Section																
PLM4S-D0	Wrap	14.6	371	0.185	4.7	0.052	1.3	0.44 x 2.00	11.1 x 50.8	4.00	102	50	222	GTS-E, GS2B-E, GTH-E, GS4H-E, PTS, PTH, PPTS, STS2, STH2	500	5000

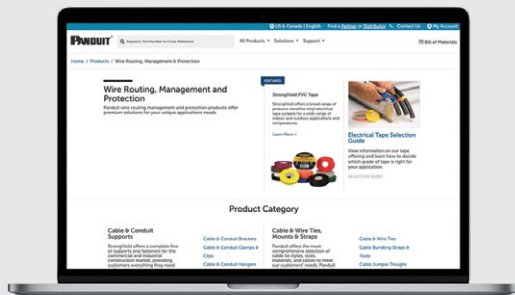

Like what you see? Want more?

Visit www.panduit.com for the full offering of Panduit products

www.panduit.com



Dome-Top® Barb Ty Cable Ties – Nylon 6.6

- For indoor use
- Dome-top head features unique patented design with round, smooth edges
- Stainless steel locking barb provides consistent performance, reliability, and infinite adjustability through entire bundle range
- High strength and low thread force
- A variety of materials and colors are available for specific applications
- Curved tip is easy to pick up from flat surfaces and allows faster initial threading to speed installation
- UL Listed for use in plenum or air handling spaces per NEC

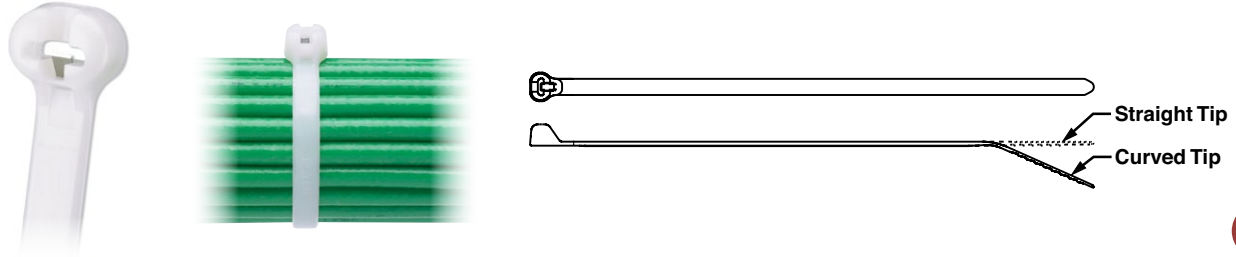

Part Number	Length In. (mm)	Width In. (mm)	Max Bundle Diameter In. (mm)	Material	Color	Resistance Properties	AH-2 Plenum Rated	UL 94 Flammability Rating	UL 62275 Type	Pkg. Qty.	Installation Tools
Miniature Cross Section											
BT1M-C	4.0 (102)	0.095 (2.4)	0.90 (23)	Nylon 6.6	Natural	—	✓	V2	2, 21	100	GTS-E, GS2B-E, PTS, PPTS, STS2
Intermediate Cross Section											
BT1.5I-C	6.1 (155)	0.141 (3.6)	1.50 (38)	Nylon 6.6	Natural	—	✓	V2	2, 21	100	GTS-E, GS2B-E, PTS, PPTS, STS2
BT2I-C	8.0 (203)	0.141 (3.6)	2.00 (51)								
BT3I-C	11.3 (287)	0.141 (3.6)	3.00 (76)								
Standard Cross Section											
BT2S-C	8.0 (203)	0.185 (4.7)	2.00 (51)	Nylon 6.6	Natural	—	✓	V2	2, 21, 2S, 21S	100	GTS-E, GS2B-E, GTH-E, GS4H-E, PTS, PTH, PPTS, STS2, STH2
BT3S-C	12.0 (305)	0.185 (4.7)	3.00 (76)								
BT4S-C	15.1 (384)	0.185 (4.7)	4.00 (102)								
BEST SELLER BT4S-M	15.1 (384)	0.185 (4.7)	4.00 (102)							1000	
Light-Heavy Cross Section (Straight Tip)											
BT4LH-L	14.9 (378)	0.275 (7.0)	4.00 (102)	Nylon 6.6	Natural	—	✓	V2	2, 21, 2S, 21S	50	GTH-E, GS4H-E, GS4EH-E, PTH, STH2, ST3EH
BT5LH-L	18.1 (460)	0.275 (7.0)	5.00 (127)								
BT7LH-L	24.4 (620)	0.275 (7.0)	7.00 (178)								
BT9LH-L	30.7 (780)	0.275 (7.0)	9.00 (229)								



Dome-Top® Barb Ty Cable Ties – Weather Resistant Nylon 6.6

- Greater resistance to damage caused by ultraviolet light – indoor or outdoor use
- Dome-top head features unique patented design with round, smooth edges
- Stainless steel locking barb provides consistent performance, reliability, and infinite adjustability through entire bundle range
- High strength and low thread force
- Curved tip is easy to pick up from flat surfaces and allows faster initial threading to speed installation
- UL Listed for use in plenum or air handling spaces per NEC

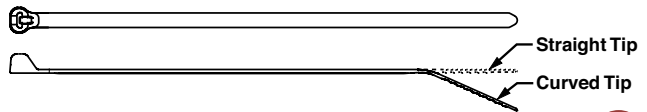

Part Number	Length In. (mm)	Width In. (mm)	Max Bundle Diameter In. (mm)	Material	Color	Resistance Properties	AH-2 Plenum Rated	UL 94 Flammability Rating	UL 62275 Type	Pkg. Qty.	Installation Tools
Miniature Cross Section											
BT1M-C0	4.0 (102)	0.095 (2.4)	0.90 (23)	Weather Resistant Nylon 6.6	Black	UV Resistant	✓	V2	2, 21	100	GTS-E, GS2B-E, PTS, PPTS, STS2
BT1.5M-C0	6.3 (160)	0.095 (2.4)	1.50 (38)								
BT2M-C0	7.9 (201)	0.095 (2.4)	2.00 (51)								
Intermediate Cross Section											
BT1.5I-C0	6.1 (155)	0.141 (3.6)	1.50 (38)	Weather Resistant Nylon 6.6	Black	UV Resistant	✓	V-2	2, 21	100	GTS-E, GS2B-E, PTS, PPTS, STS2
BT2I-C0	8.0 (203)	0.141 (3.6)	2.00 (51)								
BEST SELLER BT3I-C0	11.3 (287)	0.141 (3.6)	3.00 (76)								
BT4I-C0	14.3 (363)	0.141 (3.6)	4.00 (102)								
Standard Cross Section											
BT2S-C0	8.0 (203)	0.185 (4.7)	2.00 (51)	Weather Resistant Nylon 6.6 Weather	Black	UV Resistant	✓	V-2	2, 21, 2S, 21S	100	GTS-E, GS2B-E, GTH-E, GS4H-E, PTS, PTH, PPTS, STS2, STH2
BEST SELLER BT2S-M0	8.0 (203)	0.185 (4.7)	2.00 (51)							1000	
BEST SELLER BT3S-C0	12.0 (305)	0.185 (4.7)	3.00 (76)							100	
BEST SELLER BT3S-M0	12.0 (305)	0.185 (4.7)	3.00 (76)							1000	
BEST SELLER BT4S-C0	15.1 (384)	0.185 (4.7)	4.00 (102)							100	
BEST SELLER BT4S-M0	15.1 (384)	0.185 (4.7)	4.00 (102)							1000	

(continued on next page)



Dome-Top® Barb Ty Cable Ties – Weather Resistant Nylon 6.6 (continued)

Part Number	Length In. (mm)	Width In. (mm)	Max Bundle Diameter In. (mm)	Material	Color	Resistance Properties	AH-2 Plenum Rated	UL 94 Flammability Rating	UL 62275 Type	Pkg. Qty.	Installation Tools
Light-Heavy Cross Section (Straight Tip)											
BT2LH-L0	8.7 (221)	0.275 (7.0)	2.00 (51)	Weather Resistant Nylon 6.6	Black	UV Resistant	✓	V-2	2, 21, 2S, 21S	50	GTH-E, GS4H-E, GS4EH-E, PTH, STH2, ST3EH
BT3LH-L0	11.8 (300)	0.275 (7.0)	3.00 (76)								
BEST SELLER BT4LH-L0	14.9 (378)	0.275 (7.0)	4.00 (102)								
BEST SELLER BT4LH-TL0	14.9 (378)	0.275 (7.0)	4.00 (102)								
BEST SELLER BT5LH-L0	18.1 (460)	0.275 (7.0)	5.00 (127)							50	
BEST SELLER BT5LH-C0	18.1 (460)	0.275 (7.0)	5.00 (127)							100	
BT7LH-L0	24.4 (620)	0.275 (7.0)	7.00 (178)							50	
BT9LH-L0	30.7 (780)	0.275 (7.0)	9.00 (229)								

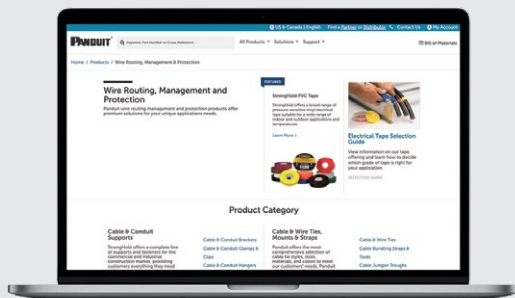

Like what you see? Want more?

Visit www.panduit.com for the full offering of Panduit products

www.panduit.com



Dome-Top® Barb Ty Cable Ties – Heat Stabilized Nylon 6.6

- For high temperature applications up to 239°F (115°C) – indoor use
- Dome-top head features unique patented design with round, smooth edges
- Stainless steel locking barb provides consistent performance, reliability, and infinite adjustability through entire bundle range
- Curved tip is easy to pick up from flat surfaces and allows faster initial threading to speed installation



BT2S-M30



BT2S-M39

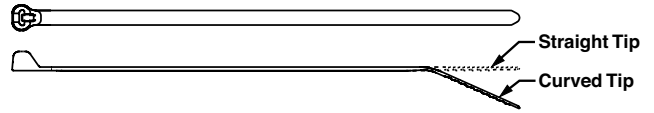

Part Number	Length In. (mm)	Width In. (mm)	Max Bundle Diameter In. (mm)	Material	Color	Resistance Properties	AH-2 Plenum Rated	UL 94 Flammability Rating	UL 62275 Type	Pkg. Qty.	Installation Tools
-------------	--------------------	-------------------	------------------------------------	----------	-------	--------------------------	-------------------------	---------------------------------	---------------------	--------------	-----------------------

Miniature Cross Section

BT2M-M30	7.9 (201)	0.095 (2.4)	2.00 (51)	Heat Stabilized Nylon 6.6	Black	Heat Resistant	—	V2	2, 21	1000	GTS-E, GS2B-E, PTS, PPTS, STS2
----------	--------------	----------------	--------------	---------------------------------	-------	-------------------	---	----	-------	------	--

Intermediate Cross Section

BT1.5I-M30	6.1 (155)	0.141 (3.6)	1.50 (38)	Heat Stabilized Nylon 6.6	Black	Heat Resistant	—	V2	2, 21	1000	GTS-E, GS2B-E, PTS, PPTS, STS2
BT3I-M30	11.3 (287)	0.141 (3.6)	3.00 (76)								

Standard Cross Section

BT2S-M30	8.0 (203)	0.185 (4.7)	2.00 (51)	Heat Stabilized Nylon 6.6	Black	Heat Resistant	—	V2	2, 21	1000	GTS-E, GS2B-E, GTH-E, GS4H-E, PTS, PTH, PPTS, STS2 STH2
BT2S-M39	8.0 (203)	0.185 (4.7)	2.00 (51)		Natural						
BT4S-M30	15.1 (384)	0.185 (4.7)	4.00 (102)		Black						



Dome-Top® Barb Ty Clamp Ties – Nylon 6.6

- For indoor use
- Used to secure a cable bundle to another surface such as a control panel, communication rack, wall or ceiling
- Design allows for bundling before or after screwing clamp in place

- Stainless steel locking barb provides consistent performance, reliability, and infinite adjustability through entire bundle range
- Curved tip is easy to pick up from flat surfaces and allows faster initial threading to speed installation
- UL Listed for use in plenum or air handling spaces per NEC

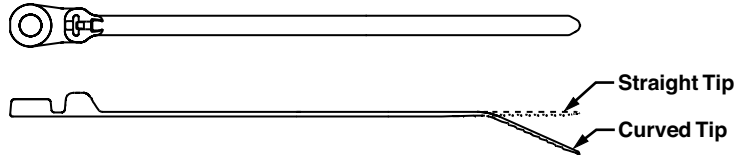

Standard Cross Section

Part Number	Length In. (mm)	Width In. (mm)	Max Bundle Diameter In. (mm)	Material	Color	Resistance Properties	AH-2 Plenum Rated	UL 94 Flammability Rating	UL 62275 Type	Pkg. Qty.	Installation Tools
BC2S-S10-C	8.5 (216)	0.185 (4.7)	2.00 (51)	Nylon 6.6	Natural	—	✓	V2	2, 21	100	GTS-E, GS2B-E, GTH-E, GS4H-E



Dome-Top® Barb Ty Clamp Ties – Weather Resistant and Heat Stabilized Nylon 6.6

- Weather Resistant material has greater resistance to damage caused by ultraviolet light – indoor or outdoor use
- Heat stabilized material for high temperature applications up to 239°F (115°C) – indoor use
- Used to secure a cable bundle to another surface such as a control panel, communication rack, wall or ceiling

- Design allows for bundling before or after screwing clamp in place
- Stainless steel locking barb provides consistent performance, reliability, and infinite adjustability through entire bundle range
- Curved tip is easy to pick up from flat surfaces and allows faster initial threading to speed installation

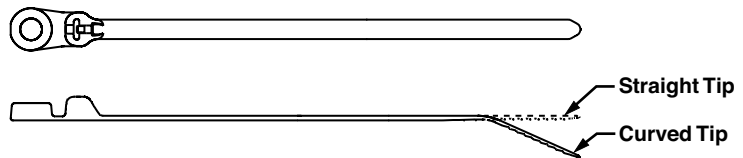

Light-Heavy Cross Section (Straight Tip)

Part Number	Length In. (mm)	Width In. (mm)	Max Bundle Diameter In. (mm)	Material	Color	Resistance Properties	AH-2 Plenum Rated	UL 94 Flammability Rating	UL 62275 Type	Pkg. Qty.	Installation Tools
BC4LH-S25-L0	15.5 (394)	0.275 (7.0)	4.00 (102)	Weather Resistant Nylon 6.6	Black	UV Resistant	—	V2	1, 11	50	GTH-E, GS4H-E, GS4EH-E

Dura-Ty™ Cable Ties – Weather Resistant Acetal – Heavy Cross Section

- Acetal strap and head materials can provide 20 years + life in outdoor applications. Factors such as installation procedures, tooling and environmental conditions can influence the actual life
- Excellent ultraviolet light, chemical, and moisture resistance
- Double stainless steel locking barbs provide consistent and predictable holding values
- Textured strap provides better gripping surface to prevent tie from moving laterally along the length of the bundle for tight, consistent bundles
- Robust head design allows tie to be tightened over a wide range of angles
- Convenient reel dispenser pack allows installer to cut-to-size for customized field applications; recyclable box has through-hole for attaching to belt, plus storage area for bag of heads
- Ideal for securing cables in outdoor messenger strand applications
- May be used with stackable aerial cable spacer, part number [SACS50-T100](#)



Part Number	Description	Strap Length		Strap Width		Min. Loop Tensile Str.		Head Height		Head Width		Recommended Installation Tool	Std. Pkg. Qty.	Std. Ctn. Qty.
		Ft.	mm	In.	mm	Lbs.	N	In.	mm	In.	mm			
Strapping, Heads, and Kit – Allows user to customize strap length														
DTRH-LR0	50' reel of strapping	50.0	15,240	0.331	8.40	200	890	—	—	—	—	GTH-E, GS4EH-E, STH2, STHV	1	20
DTHH-Q0	25 cable tie heads	—	—	—	—	—	—	0.393	9.98	0.557	14.15	—	25	500
DTKH-0	Kit: Strapping (50'), Heads (25)	50.0	15,240	0.331	8.40	200	890					GTH-E, GS4EH-E, STH2, STHV	1	20

Dura-Ty™ Cable Ties – Weather Resistant Acetal – Extra-Heavy Cross Section



Formula to determine amount of strapping required:
 Diameter (inches) x 3.14 + 4.5 inches
 Diameter (mm) x 3.14 + 114mm

Part Number	Description	Strap Length		Strap Width		Min. Loop Tensile Str.		Head Height		Head Width		Recommended Installation Tool	Std. Pkg. Qty.	Std. Ctn. Qty.
		Ft.	mm	In.	mm	Lbs.	N	In.	mm	In.	mm			
Strapping, Heads, and Kit – Allows user to customize strap length														
DTREH-LR0	50' reel of strapping	50.0	15,240	0.500	12.70	250	1112	—	—	—	—	GS4EH-E	1	20
DTHEH-Q0	25 cable tie heads	—	—	—	—	—	—	0.490	12.45	0.718	18.24	—	25	500
DTKEH-0	Kit: Strapping (50'), Heads (25)	50.0	15,240	0.500	12.70	250	1112					GS4EH-E	1	20

Part Number	Length		Width		Thickness		Nominal Hole Dia.		Max. Panel Thickness		Max Bundle Dia.		Min. Loop Tensile Str.		Recommended Installation Tool	Std. Pkg. Qty.	Std. Ctn. Qty.
	In.	mm	In.	mm	In.	mm	In.	mm	In.	mm	In.	mm	Lbs.	N			
DT4EH-L0	13.5	343	0.500	12.70	0.059	1.50	0.490	12.45	0.718	18.24	3.8	98	250	1112	GS4EH-E	50	1000
DT8EH-Q0	27.0	686									8.0	203				25	500
DT14EH-L0	48.0	1219									14.0	355				50	250
DT28EH-C0	96.0	2438									28.0	711				100	—
DT44EH-C0	144.0	3658									44.0	1117				100	—



Contour-Ty® Cable Ties – Nylon 6.6

- For indoor use
- Unique design prevents wire and cable damage
- Low profile head avoids snags and reduces overall bundle size
- Outside teeth and smooth round edges protect cable jacket – ideal for high vibration applications
- Parallel-entry limits exposure to sharp edges and protects workers' arms/hands
- Fully enclosed head for consistent strength
- Curved tip is easy to pick up from flat surfaces and allows faster initial threading to speed installation
- UL Listed for use in plenum or air handling spaces per NEC
- Nylon 6.6 cable ties in natural and colors meet the testing requirements of SAE Aerospace Standard AS23190 and the dimensional requirements of SAE Aerospace Standard AS33671

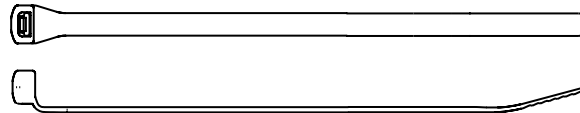

Part Number	Length In. (mm)	Width In. (mm)	Max Bundle Diameter In. (mm)	Material	Color	Resistance Properties	AH-2 Plenum Rated	UL 94 Flammability Rating	UL 62275 Type	Pkg. Qty.	Installation Tools
Miniature Cross Section											
CBR1M-M	4.1 (104)	0.098 (2.5)	1.00 (25)	Nylon 6.6	Natural	—	✓	V-2	2, 21	1000	GTS-E, GS2B-E, PTS, PPTS, STS2
CBR1.5M-M	5.8 (147)	0.098 (2.5)	1.50 (38)								
CBR2M-M	7.3 (185)	0.098 (2.5)	2.00 (51)								
Intermediate Cross Section											
CBR3I-M	10.4 (264)	0.140 (3.6)	3.00 (76)	Nylon 6.6	Natural	—	✓	V-2	2, 21	1000	GTS-E, GS2B-E, PTS, PPTS, STS2
Standard Cross Section											
CBR3S-M	10.8 (274)	0.190 (4.8)	3.00 (76)	Nylon 6.6	Natural	—	✓	V-2	2, 21	1000	GTS-E, GS2B-E, GTH-E, GS4H-E, PTS, PTH, PPTS, STS2 STH2
CBR4S-M	14.0 (356)	0.190 (4.8)	4.00 (102)								



Contour-Ty® Cable Ties – Weather Resistant Nylon 6.6

- Greater resistance to damage caused by ultraviolet light – indoor or outdoor use
- Unique design prevents wire and cable damage
- Low profile head avoids snags and reduces overall bundle size
- Outside teeth and smooth round edges protect cable jacket – ideal for high vibration applications
- Parallel-entry limits exposure to sharp edges and protects workers' arms/hands
- Fully enclosed head for consistent strength
- Curved tip is easy to pick up from flat surfaces and allows faster initial threading to speed installation

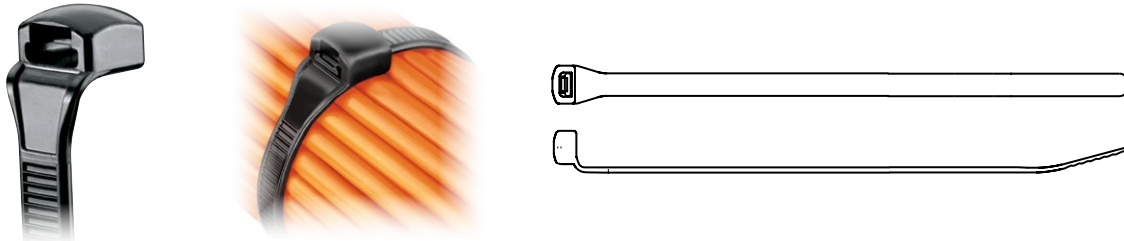

Part Number	Length In. (mm)	Width In. (mm)	Max Bundle Diameter In. (mm)	Material	Color	Resistance Properties	AH-2 Plenum Rated	UL 94 Flammability Rating	UL 62275 Type	Pkg. Qty.	Installation Tools
Miniature Cross Section											
CBR1M-M0	4.1 (104)	0.098 (2.5)	1.00 (25)	Weather Resistant Nylon 6.6	Black	UV Resistant	✓	V-2	2, 21	1000	GTS-E, GS2B-E, PTS, PPTS, STS2
Intermediate Cross Section											
CBR1.5I-M0	5.9 (150)	0.140 (3.6)	1.50 (38)	Weather Resistant Nylon 6.6	Black	UV Resistant	—	V-2	2, 21	1000	GTS-E, GS2B-E, PTS, PPTS, STS2
Standard Cross Section											
CBR2S-M0	7.6 (193)	0.190 (4.8)	2.00 (51)	Weather Resistant Nylon 6.6	Black	UV Resistant	—	V-2	2, 21	1000	GTS-E, GS2B-E, GTH-E, GS4H-E, PTS, PTH, PPTS, STS2, STH2
CBR3S-M0	10.8 (274)	0.190 (4.8)	3.00 (76)				✓				
CBR4S-M0	14.0 (356)	0.190 (4.8)	4.00 (102)				✓				

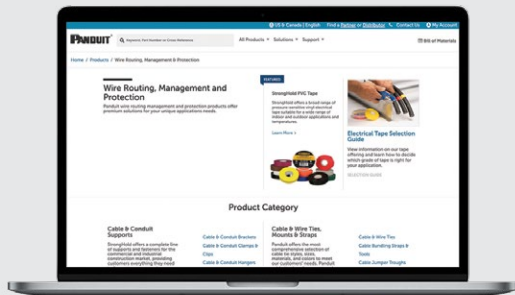

Like what you see? Want more?

Visit www.panduit.com for the full offering of Panduit products

www.panduit.com



Contour-Ty® Cable Ties – Heat Stabilized Nylon 6.6

- Heat stabilized material for high temperature applications up to 239°F (115°C) – indoor use
- Unique design prevents wire and cable damage
- Low profile head avoids snags and reduces overall bundle size
- Outside teeth and smooth round edges protect cable jacket – ideal for high vibration applications
- Parallel-entry limits exposure to sharp edges and protects workers' arms/hands
- Fully enclosed head for consistent strength
- Curved tip is easy to pick up from flat surfaces and allows faster initial threading to speed installation

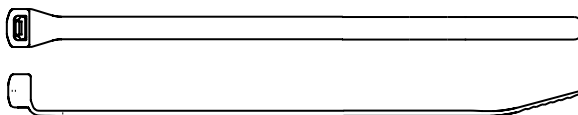

Standard Cross Section

Part Number	Length In. (mm)	Width In. (mm)	Max Bundle Diameter In. (mm)	Material	Color	Resistance Properties	AH-2 Plenum Rated	UL 94 Flammability Rating	UL 62275 Type	Pkg. Qty.	Installation Tools
CBR2S-M39	7.6 (193)	0.190 (4.8)	2.00 (51)	Heat Stabilized Nylon 6.6	Natural	Heat Resistant	—	V-2	2, 21	1000	GTS-E, GS2B-E, GTH-E, GS4H-E, PTS, PTH, PPTS, STS2, STH2

Hyper-V™ In-Line Cable Ties – Weather Resistant Nylon 6.6

- Fixed and flexible two-wedge locking design provides a low threading force
- Teeth on both sides of cable tie body provide additional locking strength and improved flexibility to conform to irregular bundle shapes such as securing cables to cable tray systems
- Releasable head position for temporary bundling of cables prior to final locking; no need to replace ties when adding cables/wires to the bundle
- Teeth on full length of body support a wide range of bundle diameters
- Bending serrations on the tip of the tie allow the tip to be easily formed into an arc, enabling installer to “fish” the tie around the bundle in a confined space
- Threading hole in the tip of the tie allows an installer to hook the tip with a simple device to pull the tie through spaces with limited access
- In-Line tie design for parallel-entry of the tie into head resulting in a lower profile on cable bundles
- Complementary mounts shown below



Part Number	Length In. (mm)	Width In. (mm)	Max Bundle Diameter In. (mm)	Material	Color	Resistance Properties	AH-2 Plenum Rated	UL 94 Flammability Rating	UL 62275 Type	Pkg. Qty.	Installation Tools
HV9150-C0	20.7 (525)	0.350 (8.9)	5.90 (150)	Weather Resistant Nylon 6.6	Black	UV Resistant	—	V2	—	100	GTH-E, GS4H-E, GS4EH-E, PTH, STH2, ST3EH, STHV



Panduit Locking Tie Stud Mounted Cable Ties – Heat Stabilized Weather Resistant Nylon 6.6

- Heat stabilized weather resistant material has greater resistance to damage caused by ultraviolet light and for high temperature applications up to 293°F (115°C) – indoor or outdoor use
- Integral mount pushes onto a threaded stud and tie wraps around bundle
- Tie can be removed from the stud by turning counterclockwise
- Curved tip is easy to pick up from flat surfaces and allows faster initial threading to speed installation

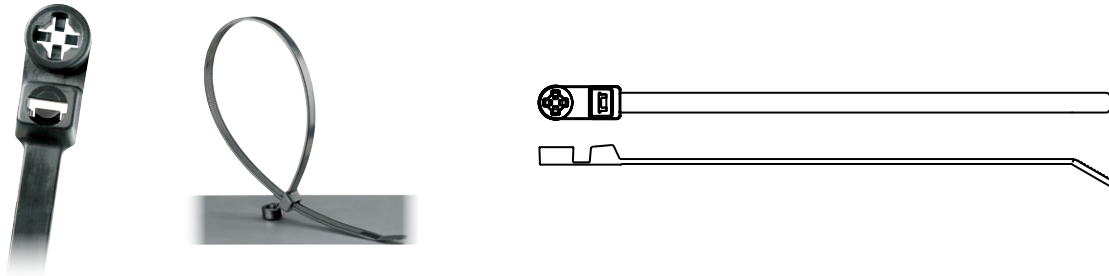

Light-Heavy Cross Section

Part Number	Length In. (mm)	Width In. (mm)	Max Bundle Diameter In. (mm)	Material	Color	Resistance Properties	AH-2 Plenum Rated	UL 94 Flammability Rating	UL 62275 Type	Pkg. Qty.	Installation Tools
PLST4HS25-TL300	15.3 (389)	0.300 (7.6)	4.00 (102)	Heat Stabilized Weather Resistant Nylon 6.6	Black	Heat and UV Resistant	—	V2	—	250	GTH-E, GS4H-E, GS4EH-E, PTH, STH2, ST3EH

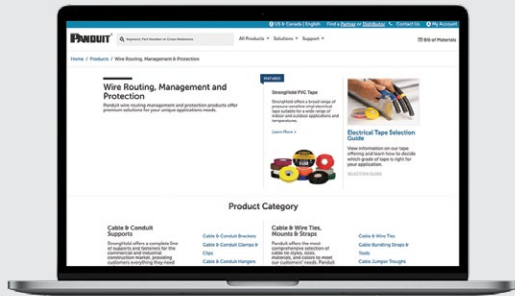

**Like what you see?
Want more?**

Visit www.panduit.com for the full offering of Panduit products

Panduit Locking Tie Double Loop Cable Ties

- Weather resistant material has greater resistance to damage caused by ultraviolet light – indoor or outdoor use
- Heat stabilized material for high temperature applications up to 239°F (115°C) – indoor use
- A fast and economical method to secure and separate two bundles
- Reduces part number inventory – single part covers multiple bundle sizes
- Installs easily by hand – second loop can be installed with Panduit® cable tie installation tools

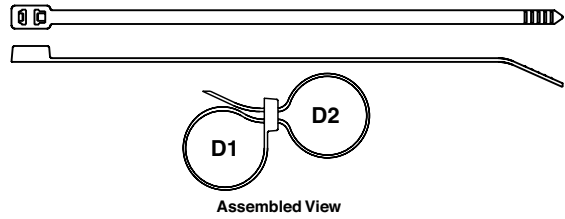

Part Number	Max. Combined Bundle Dia. D1+D2		Length		Width		Thickness		Min. Loop Tensile Str.		Recommended Installation Tool	Std. Pkg. Qty.	Std. Ctn. Qty.
	In.	mm	In.	mm	In.	mm	In.	mm	lbs.	N			

Weather Resistant Nylon 6.6 Standard Cross Section

PLB2S-C0	1.80	46	7.6	193	0.190	4.8	0.052	1.3	50	222	GTS-E, GS2B-E, GTH-E, GS4H-E, PTS, PTH, PPTS, STS2, STH2	100	1000
PLB4S-M0	4.10	104	14.8	376									

Light-Heavy Cross Section

PLB4H-TL0	3.60	91	14.7	373	0.300	7.6	0.075	1.9	120	534	GTH-E, GS4H-E, GS4EH-E, PTH, STH2, ST3EH	250	2500
------------------	------	----	------	-----	-------	-----	-------	-----	-----	-----	---	-----	------

Heat Stabilized Nylon 6.6 Standard Cross Section

PLB2S-M30	1.80	46	7.6	193	0.190	4.8	0.052	1.3	50	222	GTS-E, GS2B-E, GTH-E, GS4H-E, PTS, PTH, PPTS, STS2, STH2	1000	10000
PLB3S-M30	3.00	76	11.8	300									

Panduit Locking Tie Double Clamp Cable Ties



Material: Impact modified heat stabilized weather resistant Nylon 6.6.
239°F (115°C)

Part Number	Max Bundle Diameter		Length		Width		Thickness		Min. Loop Tensile		Recommended Installation Tool	Std. Pkg. Qty.	Std. Ctn. Qty.
	In.	mm	In.	mm	In.	mm	In.	mm	lbs.	N			
PLDC1.5EH-C350	1.3	33	13.1	333	0.5	12.70	0.055	1.4	150	667	GTH-E, GS4EH-E, PTEH	100	500
PLDC2.5EH-C350	2.3	58	19.2	489									

ABMQ Multiple Bridge Adhesive Backed Cable Tie Mounts



- Multiple cable tie bridges on one mount speeds installation of cable bundles by reducing the number of mounts applied
- Dovetail connection system provides alignment and a joining method to expand routing capabilities
- V-groove allows for easy separation into two mounts with two bridges each for separate applications
- 4-way cable tie bridges allow cable bundles to be secured perpendicular to the mount for even spacing or inline to secure a bundle in multiple places
- Large adhesive surface area provides long-term reliability and keeps product in place despite heavy load or high stress

Part Number	Used with Cable Ties‡	Material	Color	Suitable Environment	Mounting Method	Std. Pkg. Qty.	Std. Ctn. Qty.
ABMQS-A-C	M, I, S	ABS	White	Indoor	Rubber	100	1000

‡Cable tie cross section sizes: M = Miniature, I = Intermediate, and S = Standard.

Epoxy Applied Mounts



- Provide a fast, strong, economical method to secure wire/ cable to most surfaces
- Eliminate the need to drill holes
- Adhesive not included. Order [EMA-X](#). Each cup contains adhesive for three EMS mounts

Part Number	Used with Cable Ties‡	Material	Color	Suitable Environment	Mounting Method	Std. Pkg. Qty.	Std. Ctn. Qty.
EMS-A-C0	M, I, S	Weather Resistant Nylon 6.6	Black	Outdoor	EMA epoxy	100	1000

‡Cable tie cross section sizes: M = Miniature, I = Intermediate, and S = Standard.

Epoxy Applied Swivel Mount

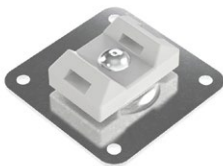

- Swivels 360° to assure proper orientation with harness
- Four inspection holes to check adhesive coverage
- For indoor use only
- Adhesive not included. Order [EMA-X](#). Each cup contains adhesive for three ASMS mounts

Part Number	Used with Cable Ties‡	Mounting Method	Std. Pkg. Qty.	Std. Ctn. Qty.
ASMS-A-X	M, I, S, SGM, SGI	EMA epoxy	10	1000

‡Cable tie cross section sizes: M = Miniature, I = Intermediate, S = Standard, SGM = Super-Grip® Miniature, and SGI = Super-Grip® Intermediate."



Cable Tie Mounts – Screw Applied

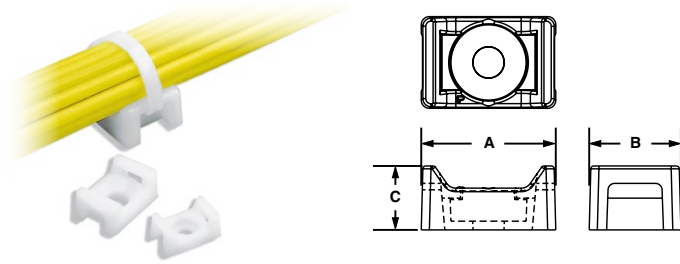

- UL 62275 Type 2, 21 per UL file E136577
- Unique cradle design provides maximum stability for the cable bundles
- Low profile design keeps bundle close to mounting surface

BEST SELLER

BEST SELLER

BEST SELLER

Part Number	Compatible Cross-Section Cable Ties‡	Length (A) In. (mm)	Width (B) In. (mm)	Height (C) In. (mm)	Material	Color	Screw Size	Suitable Environment	Std. Pkg. Qty.	
TM1S6-C	M	.51 (13.0)	.32 (8.0)	.23 (5.8)	Nylon 6.6	Natural	#6 (M3)	Indoor	100	
TM2S6-C	M, I, S	.63 (16.0)	.43 (10.8)	.28 (7.0)		Weather Resistant Nylon 6.6				Black
TM2S8-C					Nylon 6.6	Natural	Indoor			
TM2S8-C0	Weather Resistant Nylon 6.6	Black	Outdoor							
TM3S8-C	M, I, S, LH	.86 (21.9)	.61 (15.5)	.37 (9.4)	Nylon 6.6	Natural	#10 (M5)	Indoor		
TM3S8-C0					Weather Resistant Nylon 6.6	Black		Outdoor		
TM3S10-C	M, I, S, LH	.86 (21.9)	.61 (15.5)	.37 (9.4)	Nylon 6.6	Natural	#10 (M5)	Indoor		
TM3S10-C0						Black		Outdoor		
TM3S10-M	M, I, S, LH	.86 (21.9)	.61 (15.5)	.37 (9.4)	Nylon 6.6	Natural	1/4 (M6) screw	Indoor		1000
TM3S25-C						M, I, S, LH		.88 (22.3)		.63 (16.0)
TM3S25-C0	Weather Resistant Nylon 6.6	Black	Outdoor							

‡Cable tie cross section sizes: M = Miniature, I = Intermediate, S = Standard, LH = Light-Heavy.

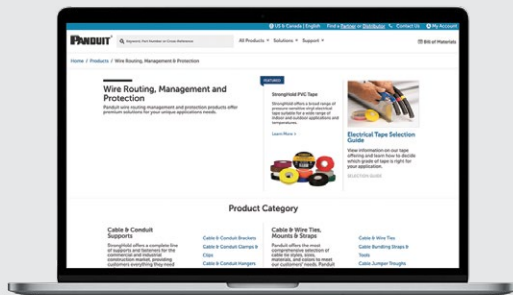

Like what you see? Want more?

Visit www.panduit.com for the full offering of Panduit products

www.panduit.com



Extra-Heavy Cable Tie Mounts – Screw Applied

- UL 62275 Type 2, 21 per UL file E136577
- Unique cradle design provides maximum stability for the cable bundles
- Route and support large diameter and heavy cable bundles
- Can also be used with Tak-Ty™ Hook & Loop ties

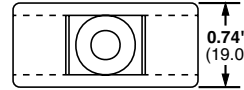
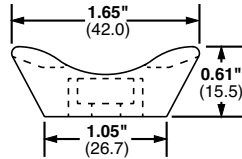

Part Number	Compatible Cross-Section Cable Ties†	Material	Color	Screw Size	Suitable Environment	Std. Pkg. Qty.
TMEH-S8-Q0	M, I, S, HS, LH, H, EH, HLM	Weather Resistant Nylon 6.6	Black	#8 (M4)	Outdoor	25
TMEH-S10-C0				#10 (M5)		100
TMEH-S10-Q0		25				
TMEH-S10-C100		Weather Resistant Polypropylene				100
TMEH-S25-C0		Weather Resistant Nylon 6.6				1/4 (M6)
TMEH-S25-Q0						

†Cable tie cross section sizes: M = Miniature, I = Intermediate, S = Standard, HS = Heavy-Standard, LH = Light-Heavy, H = Heavy, EH = Extra-Heavy and HLM = Miniature Tak-Ty® Hook & Loop Ties.

High and Medium Torque Tie Mounts



- A retention tab within the mount bolt hole creates interference to hold the bolt in different positions without any external assistance.
- TMEH4 version includes a steel insert (as shown in image). TMEH3 version does not come with steel insert

Part Number	Used with Cable Ties*	Material	Torque (Ft.-lbs.)	Color	Suitable Environment	Mounting Method	Std. Pkg. Qty.	Std. Ctn. Qty.
TMEH4S8-D350	M, I, S, HS, LH, H, EH, WS	Impact Modified Heat Stabilized Weather Resistant Nylon 6.6 with Zinc Plated Steel Insert	114	Black	Outdoors or Indoors	5/16" (8mm) bolt	500	—
TMEH4S10-D350						3/8" (10mm) bolt		
TMEH3S8-D350		Impact Modified Heat Stabilized Weather Resistant Nylon 6.6	40			5/16" (8mm) bolt		
TMEH3S10-D350						3/8" (10mm) bolt		

*Cable tie cross section sizes: M = Miniature, I = Intermediate, S = Standard, HS = Heavy-Standard, LH = Light-Heavy, H = Heavy, EH = Extra Heavy, WS = Wide Strap.

Swivel Mounts



- The two mounts are securely fastened together with a connecting rivet that allows both mounts to rotate
- Can join bundles of cable, tubing, or hoses that may need to move or are not parallel
- Separates bundles to avoid abrasion
- Material: Weather Resistant Nylon 6.6

Part Number	Used with Cable Ties‡	Pull Apart Force		Color	Suitable Environment	Std. Pkg. Qty.	Std. Ctn. Qty.
		lbs	g				
TM3-X2-C0Y	M, I, S, HS, LH	120	54,431	Black	Indoor/Outdoor	100	1000
TMEH-X2-L0Y	M, I, S, HS, LH, H, EH, HLM	250	113,398				

‡Cable tie cross section sizes: M = Miniature, I = Intermediate, S = Standard, HS = Heavy-Standard, LH = Light-Heavy, H = Heavy, EH = Extra-Heavy, and HLM = Miniature Tak-Ty® Hook & Loop Ties.

4-Way Tie Anchor Mounts – Screw Applied

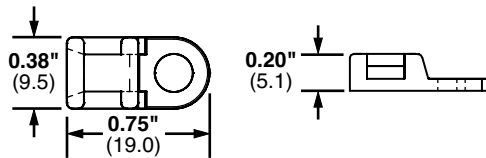
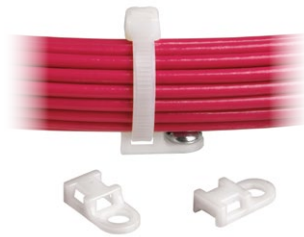

- UL 62275 Type 2, 21 per UL file E136577
- 4-way cable tie entry makes part orientation fast and easy
- Small overall size allows use where space is limited

Part Number	Compatible Cross-Section Cable Ties‡	Material	Color	Screw Size	Suitable Environment	Std. Pkg. Qty.
BEST SELLER TA1S8-C	M, I, S	Nylon 6.6	Natural	#8 (M4)	Indoor	100
BEST SELLER TA1S8-M			Black			1000
TA1S8-M0		Weather Resistant Nylon 6.6			Outdoor	

Super-Grip® Cable Tie Mounts

SGTA1S8-C*	SGM, SGI, SGS	Nylon 6.6	Natural	#8 (M4)	Indoor	100
------------	---------------	-----------	---------	---------	--------	-----

‡Cable tie cross section sizes: M = Miniature, I = Intermediate, S = Standard, SGM = Super-Grip® Miniature, SGI = Super-Grip® Intermediate, Super-Grip® Standard.

*Not UL Listed

Low Profile Mounts – Screw Applied



- Low profile design keeps bundle close to mounting surface
- Install with a screw or rivet for a strong, secure installation
- Small overall size
- For indoor use only
- Material: Nylon 6.6

Part Number	Used with Cable Ties‡	Color	Mounting Method	Std. Pkg. Qty.	Std. Ctn. Qty.
LPMS-S8-C	M, I, S	Natural	#8 (M4) Countersunk Screw	100	1000

‡Cable tie cross section sizes: M = Miniature, I = Intermediate, and S = Standard.

Contour Multiple Tie Plates

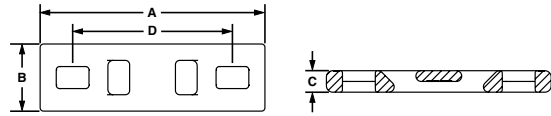
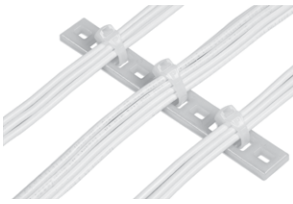

- Designed for aerospace industry to minimize chance for abrasion
- Low profile design keeps bundle close to mounting surface
- For indoor use only
- Heat stabilized Nylon 6.6 material

Part Number	No. of Bundles	Used with Cable Ties‡	Length (A)		Width (B)		Height (C)		Hole Spacing (D)		Mounting Method	Std. Pkg. Qty.	Std. Ctn. Qty.
			In.	mm	In.	mm	In.	mm	In.	mm			
MTPC3H-E10-C39	3	M, I, S, HS, LH, H	2.09	53.1	0.63	16.0	0.20	5.2	1.50	38.1	#10 (M5) Screw	100	1000

‡Cable tie cross section sizes: M = Miniature, I = Intermediate, S = Standard, HS = Heavy-Standard, LH = Light-Heavy, and H = Heavy.



Multiple Tie Plates

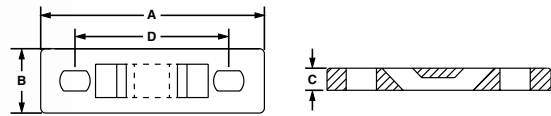

- Used to secure closely spaced wire bundles
- Low profile design keeps bundle close to mounting surface
- For indoor use only
- Material: Nylon 6.6

Part Number	No. of Bundles	Used with Cable Ties‡	Length (A)		Width (B)		Height (C)		Hole Spacing (D)		Mounting Method	Mil. Std. Part Number	Std. Pkg. Qty.	Std. Ctn. Qty.
			In.	mm	In.	mm	In.	mm	In.	mm				
MTP2S-E6-C	2	M, I, S	3.00	76.2	0.50	12.7	0.13	3.2	2.50	63.5	#6 (M3) Screw	MS3339-2-9	100	1000
MTP3S-E6-C	3	M, I, S	4.25	108.0					3.75	95.3	#6 (M3) Screw	MS3339-3-9		
MTP3H-E6-C	3	M, I, S, HS, LH, H	5.09	129.3	0.63	16.0	0.20	5.2	4.50	114.3	#6 (M3) Screw	MS3339-8-9		
MTP4S-E6-C	4	M, I, S	5.50	139.7	0.50	12.7	0.13	3.2	5.00	127.0	#6 (M3) Screw	MS3339-4-9		
MTP5H-E6-C	5	M, I, S, HS, LH, H	8.09	205.5	0.63	16.0	0.20	5.2	7.50	190.5	#6 (M3) Screw	MS3339-10-9		
MTP6H-E10-C	6	M, I, S, HS, LH, H	9.59	243.6					16.0	9.00	228.6	#10 (M5) Screw		

‡Cable tie cross section sizes: M = Miniature, I = Intermediate, S = Standard, HS = Heavy-Standard, LH = Light-Heavy, and H = Heavy.

Right Angle Mounts

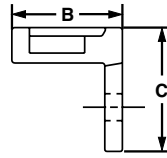
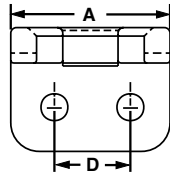

- Hold cable bundles away from the sharp edges of bulkheads or cabinet holes
- Can also be used to mount cable bundles adjacent to any surface
- For indoor use only
- Material: Nylon 6.6

Part Number	Used with Cable Ties‡	Length (A)		Width (B)		Height (C)		Hole Spacing (D)		Color	Mil. Std. Part Number	Mounting Method	Std. Pkg. Qty.	Std. Ctn. Qty.
		In.	mm	In.	mm	In.	mm	In.	mm					
RAMS-S3-M	M, I, S	0.56	14.2	0.39	8.9	0.44	11.0	0.28	7.1	Natural	MS3341-2-9	#3 (M2.5) Screw or 3/32 (2.4) Rivet	100	5000
RAMH-S6-D	M, I, S, HS, LH, H	1.00	25.4	0.75	19.1	1.00	25.4				MS3341-1-9	#6 (M3) Screw or 1/8 (3.2) Rivet	500	

‡Cable tie cross section sizes: M = Miniature, I = Intermediate, S = Standard, HS = Heavy-Standard, LH = Light-Heavy and H = Heavy.

Lightning Hole Mounts

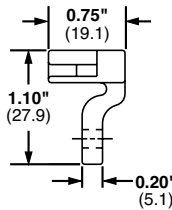
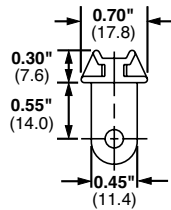

- Secure cable bundles that run through bulkhead lightning holes
- Protect cable bundles from sharp edges
- For indoor use only
- Material: Nylon 6.6

Part Number	Used with Cable Ties‡	Color	Mil. Std. Part Number	Mounting Method	Std. Pkg. Qty.	Std. Ctn. Qty.
LHMS-S6-D	M, I, S	Natural	MS3340-1-9	#6 (M3) Screw or 9/64 (3.5) Rivet	500	2500
LHMS-S10-D			—	#10 (M5) Screw or 3/16 (4.7) Rivet		

‡Cable tie cross section sizes: M = Miniature, I = Intermediate, and S = Standard.

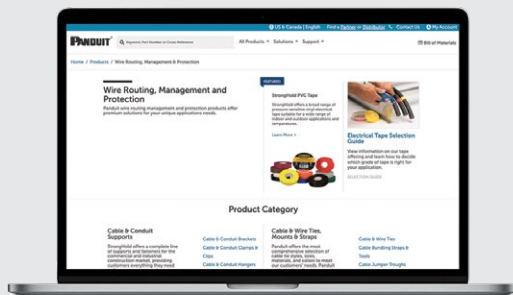

Like what you see? Want more?

Visit www.panduit.com for the full offering of Panduit products

www.panduit.com

Stud Tie Mounts



- Easily applied to bolts or studs with a light hammer blow or turning of the mount
- Designed for use with cable ties to route and secure cable bundles, air, water and hydraulic lines
- Material: Impact Modified Weather Resistant Nylon 6.6

Part Number	Used with Cable Ties‡	Color	Environment	Mounting Method	Std. Pkg. Qty.
TMSTHS11-D0	M, I, S, HS, LH, H	Black	Outdoors	7/16" stud dia. (11mm)	500
TMSTHS16-D0				5/8" stud dia. (16mm)	

‡Cable tie cross section sizes: M = Miniature, I = Intermediate, S = Standard, HS = Heavy-Standard, LH = Light-Heavy and H = Heavy.

Metal Clip-On Mounts



- Clips on sheet metal edges for fast mounting of harness with cable ties
- Allows cable tie entry from all four sides for easy harness orientation
- For indoor use only
- Material: Zinc plated steel

Part Number	Used with Cable Ties‡	Height (A)		Max. Panel Thickness		Mounting Method	Std. Pkg. Qty.	Std. Ctn. Qty.
		In.	mm	In.	mm			
MCMS12-P-C	M, I, S	0.31	8.0	0.13	3.2	Clip-On	100	500
MCMS25-P-C		0.46	11.5	0.24	6.1			
MCMS30-P-C		0.55	14.0	0.27	6.9			

‡Cable tie cross section sizes: M = Miniature, I = Intermediate, and S = Standard.

UL® US Push Barb Cable Tie Mount

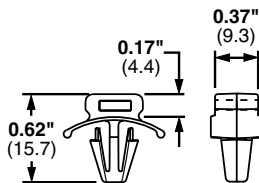

- UL 62275 Type 1, 11 per UL file E136577
- Wing provides added stability
- Requires no adhesive or additional mounting hardware
- Can be use where only one side of the panel is accessible

Part Number	Compatible Cross-Section Cable Ties‡	Max Panel Thickness In. (mm)	Panel Hole Diameter In. (mm)	Material	Color	Suitable Environment	Std. Pkg. Qty.
PWMS-H25-C	M, I, S	.11 (2.7)	.25 (6.5)	Nylon 6.6	Natural	Indoor	100
PWMS-H25-M							1000
PWMS-H25-M0				Weather Resistant Nylon 6.6	Black	Outdoor	1000

‡Cable tie cross section sizes: M = Miniature, I = Intermediate, and S = Standard.



Push Mounts

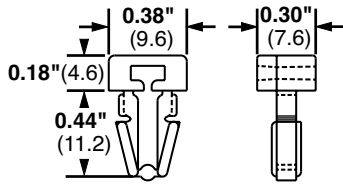

- Require no adhesive or additional mounting hardware
- Can be used where only one side of the panel is accessible

Part Number	Used with Cable Ties‡	Max. Panel Thickness		Panel Hole Diameter		Material	Color	Environment	Mounting Method	Std. Pkg. Qty.	Std. Ctn. Qty.
		In.	mm	In.	mm						
PM2H25-C	M, I, S	0.125	3.2	0.250	6.4	Nylon 6.6	Natural	Indoors	Push Barb	100	500

‡Cable tie cross section sizes: M = Miniature, I = Intermediate, and S = Standard.

Push Button Mount

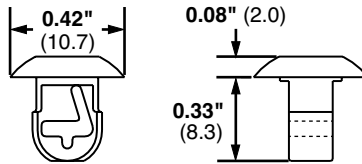

- UL 62275 Tpe 2,21 per UL file
- Requires no adhesive or additional mounting hardware
- Designed for use where both sides of the panel are accessible

Part Number	Compatible Cross-Section Cable Ties‡	Max Panel Thickness In. (mm)	Panel Hole Diameter In. (mm)	Material	Color	Suitable Environment	Pkg. Qty.
PBMS-H25-C	M, I, S	.13 (3.2)	.25 (6.4)	Nylon 6.6	Natural	Indoor	100
PBMS-H25-M		.12 (3.2)					Weather Resistant Nylon 6.6
PBMS-H25-M0		.13 (3.2)		Heat Stabilized Nylon 6.6	Black	Indoor	
PBMS-H25-M30							

BEST SELLER

‡Cable tie cross section sizes: M = Miniature, I = Intermediate, and S = Standard.

Fir Tree Push Mounts



- Unique alternating barb design
- Lock securely into position
- Umbrella tensioning
- Exclusive contoured anvil head

Part Number	Used with Cable Ties‡	Head Diameter		Panel to Top of Mount		Overall Height		Panel Hole Diameter Range		Panel Thickness Range		Material	Std. Pkg. Qty.	Std. Ctn. Qty.
		In.	mm	In.	mm	In.	mm	In.	mm	In.	mm			
PUM-049-M30	M, I, S	0.67	17.0	0.26	6.6	0.54	13.8	0.18 – 0.19	4.6 – 4.9	0.03 – 0.12	0.7 – 3.0	Heat Stabilized Nylon 6.6	1000	5000
PUM-071-M30					6.5	0.67	16.9	0.25 – 0.28	6.3 – 7.1	0.03 – 0.28	0.8 – 7.0			

‡Cable tie cross section sizes: M = Miniature, I = Intermediate, and S = Standard.



Pan-Post™ Standoff



- Supports cable bundles above or away from surface
- For indoor use only
- Material: Nylon 6.6

Part Number	Used with Cable Ties‡	Height (A)		Color	Mounting Method	Std. Pkg. Qty.	Std. Ctn. Qty.
		In.	mm				
PP2S-S10-X	M, I, S	4.60	116.8	Natural	#10 (M5) Screw	10	100
PP2S-S12-X					#12 (M5.5) Screw		

‡Cable tie cross section sizes: M = Miniature, I = Intermediate, and S = Standard.

Flat Pan-Post™ Standoffs

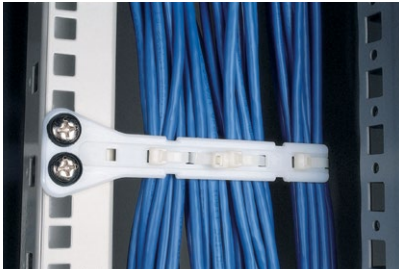

- Standard EIA hole spacing allows product to be mounted with user supplied screws up to 1/4" diameter
- Organize cables in standard cabinets and racks
- Mounting method: 1/4" (M6) screw
- Use where space is limited
- For indoor use only

Part Number	Used with Cable Ties‡	Material	Color	Mounting Method	Std. Pkg. Qty.	Std. Ctn. Qty.
PPF2S-S25-V69	M, I, S	Flame Retardant Nylon 6.6	Natural	Two 1/4" (M6) screws	5	100

‡Cable Tie Cross Section Sizes: M = Miniature, I = Intermediate, and S = Standard.



Right Angle Bases

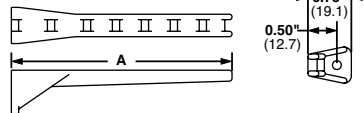

- Support cable above the mounting surface

Part Number	Used with Cable Ties‡	Max. Flat Cable Width		Length (A)		Material	Color	Environment	Mounting Method	Std. Pkg. Qty.	Std. Ctn. Qty.
		In.	mm	In.	mm						
RAFCB11-S6-C20	I	1.00	25.4	1.75	44.4	Nylon 6.6	Black	Indoors	#6 (M3) Screw	100	1000
RAFCB12-S6-C20		2.00	50.8	2.78	70.6						

‡Cable tie cross section sizes: I = Intermediate.



Closed Connector Rings



- Connect multiple cable bundles

Part Number	Used with Cable Ties‡	Length (A)		Width (B)		Height (C)		Material	Color	Environment	Mounting Method	Std. Pkg. Qty.	Std. Ctn. Qty.
		In.	mm	In.	mm	In.	mm						
CR2-M	M, I, S	0.33	8.4	0.24	6.1	0.20	5.0	Nylon 6.6	Natural	Indoors	Cable Ties	1000	10000
CR4H-M	M, I, S, HS, LH	0.57	14.5	0.36	9.1	0.30	7.6	Weather Resistant Nylon 6.6	Black	Indoors/Outdoors			
CR4H-M0													

‡Cable tie cross section sizes: M = Miniature, I = Intermediate, S = Standard, HS = Heavy-Standard, and LH = Light-Heavy.

Cable Spacers



- Used to separate and/or hang cords, cables, and tubing

Part Number	Used with Cable Ties‡	Material	Color	Environment	Mounting Method	Std. Pkg. Qty.	Std. Ctn. Qty..
CSH-D20	M, I, S, HS, LH, H	Nylon 6.6	Black	Indoors	Cable Ties	500	2500
CSH-D0		Weather Resistant Nylon 6.6		Indoors/Outdoors			

‡Cable tie cross section sizes: M = Miniature, I = Intermediate, S = Standard, HS = Heavy-Standard, LH = Light-Heavy, and H = Heavy.

Cable Spacer Cross



- Connects two bundles at 90°
- Separates bundles to prevent abrasion
- Dual cradle design stabilizes cable bundle

Part Number	Used with Cable Ties‡	Material	Color	Environment	Mounting Method	Std. Pkg. Qty.	Std. Ctn. Qty.
CSCS-M	M, I, S	Nylon 6.6	Natural	Indoors	Cable Ties	1000	10000

‡Cable tie cross section sizes: M = Miniature, I = Intermediate, and S = Standard.

Stackable Aerial Cable Spacer



- Greater resistance to damage caused by ultraviolet light – indoor or outdoor use
- Each spacer snaps into another to increase spacer heights by 1/2" increments
- Designed for use in parallel or perpendicular applications
- For use with [Dura-Ty™](#) Cable Ties shown on 49

Part Number	Used with Cable Ties‡	Material	Color	Environment	Mounting Method	Std. Pkg. Qty.	Std. Ctn. Qty.
SACS50-T100	LH, H, EH	Weather Resistant Polypropylene	Black	Outdoors	Cable Ties	200	2000

‡Cable tie cross section sizes: LH = Light-Heavy, H = Heavy, and EH = Extra-Heavy.

Aerial Support Ties – Weather Resistant Polypropylene

- Designed to attach coax or telephone cable to the 1/4" (6.4mm) or 5/16" (7.9mm) support strand to form the expansion loop and keep equipment and cables clear of pole hardware
- One-piece construction with integral 1/2" (12.7mm) spacer reduces inventory costs of separate spacer and bands, and installs faster to lower installed cost
- Releasable and re-usable
- Hand install only



Part Number	Length (A)		Max Bundle Diameter		Min Loop Tensile Strength		Std. Pkg. Qty.	Std. Ctn. Qty.
	In.	mm	In.	mm	In.	mm		
AST20-5-C100	8.4	214	2.00	51	75	334	100	1000
AST25-5-C100	10.0	254	2.50	64				

Marker Plates – Loose Piece

- Install as flags, tags, or wrap-around identification plates to clearly identify all wire harnesses
- Use with nylon marking pens for an easy and economic alternative to identify wire harnesses
- Available in black or white to match the wire harness
- Thickness: 0.02 inches (0.5mm)



Part Number	Used with Cable Ties‡	Length (A)		Width (B)		Hole Spacing (C)		Material	Color	Environment	Mounting Method	Std. Pkg. Qty.	Std. Ctn. Qty.
		In.	mm	In.	mm	In.	mm						
MP250-C	M, I, S	2.50	63.5	0.75	19.0	2.03	51.6	Nylon 6.6	White	Indoors	Cable Ties	100	500
MP350-C		3.50	88.9			3.03	77.7						1000
MP250W175-C		2.50	63.5	1.75	44.5	2.03	51.6						

‡Cable tie cross section sizes: M = Miniature, I = Intermediate, and S = Standard.

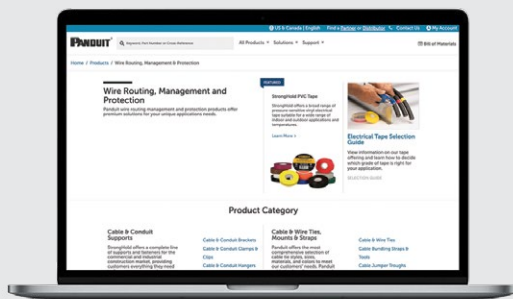

Like what you see? Want more?

Visit www.panduit.com for the full offering of Panduit products

www.panduit.com

c US 4-Way Adhesive Backed Cable Tie Mounts

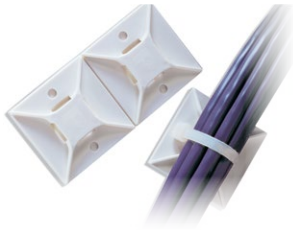

- UL 62275 Type 1, 11 per UL file E136577
- Produced 2-up or 4-up for fast and easy liner removal for speed of installation
- Flammability Rating: –Nylon 6.6 V-2, ABS HB

	Part Number	L x W In. (mm)	Compatible Cross-Section Cable Ties‡	Material	Color	Adhesive Base	Suitable Environment	Static Load Capacity lbs. (g)	Std. Pkg. Qty.
BEST SELLER	ABM1M-A-M	0.50 x 0.50 (12.7 x 12.7)	M	Nylon 6.6	White	Rubber	Indoor	.13 (59)	1000
	ABM1M-AT-MO			Weather Resistant Nylon 6.6	Black	Acrylic	Outdoor		
BEST SELLER	ABMM-A-C	0.75 x 0.75 (19.1 x 19.1)	M, I	ABS	White	Rubber	Indoor	.30 (136)	100
	ABMM-AT-CO			Weather Resistant ABS	Black	Acrylic	Outdoor		
BEST SELLER	ABMM-A-D	0.75 x 0.75 (19.1 x 19.1)	M, I	ABS	White	Rubber	Indoor		500
	ABMM-AT-DO			Weather Resistant ABS	Black	Acrylic	Outdoor		
BEST SELLER	ABM2S-A-C	1.00 x 1.00 (25.4 x 25.4)	M, I, S	ABS	White	Rubber	Indoor	.50 (227)	100
	ABM2S-AT-CO			Weather Resistant ABS	Black	Acrylic	Outdoor		
BEST SELLER	ABM2S-A-D	1.00 x 1.00 (25.4 x 25.4)	M, I, S	ABS	White	Rubber	Indoor		500
	ABM2S-AT-DO			Weather Resistant ABS	Black	Acrylic	Outdoor		
BEST SELLER	ABM100-A-C	1.00 x 1.00 (25.4 x 25.4)	M, I, S	Nylon 6.6	White	Rubber	Indoor	.63 (286)	100
	ABM100-AT-CO			Weather Resistant Nylon 6.6	Black	Acrylic	Outdoor		
BEST SELLER	ABM112-A-C	1.12 x 1.12 (28.6 x 28.6)	M, I, S	Nylon 6.6	White	Rubber	Indoor		500
	ABM112-AT-CO			Weather Resistant Nylon 6.6	Black	Acrylic	Outdoor		
	ABM3H-A-L	1.50 x 1.50 (38.1 x 38.1)	M, I, S, LH, H	Nylon 6.6	White	Rubber	Indoor	1.13 (513)	50
	ABM3H-AT-LO			Weather Resistant Nylon 6.6	Black	Acrylic	Outdoor		
	ABM4H-A-L	2.00 x 2.00 (50.8 x 50.8)	M, I, S, LH, H	Nylon 6.6	White	Rubber	Indoor	2.0 (907)	200
	ABM4H-AT-TO			Weather Resistant Nylon 6.6	Black	Acrylic	Outdoor		

‡Cable tie cross section sizes: M = Miniature, I = Intermediate, S = Standard, LH = Light Heavy and H = Heavy.

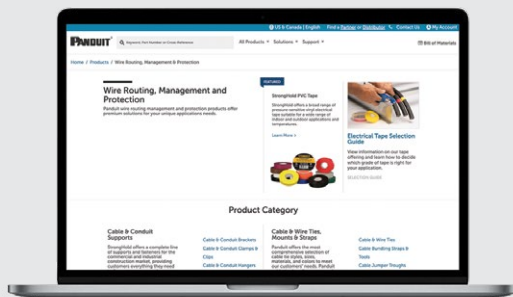

Like what you see? Want more?

Visit www.panduit.com for the full offering of Panduit products

www.panduit.com

< PREVIOUS PAGE | TABLE OF CONTENTS | NEXT PAGE >

Super-Grip™ Adhesive Backed Cable Tie Mounts

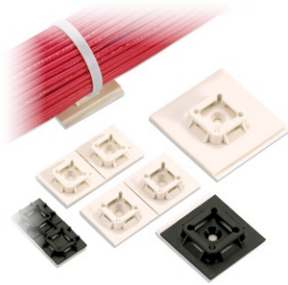

- For use with Super-Grip™ Cable Ties
- Low profile design keeps bundle close to mounting surface
- Small overall size allows use where space is limited
- Produced 2-up for fast and easy liner removal for speed of installation

BEST SELLER

BEST SELLER

BEST SELLER

Part Number	L x W In. (mm)	Compatible Cross-Section Cable Ties‡	Material	Color	Adhesive Base	Suitable Environment	Static Load Capacity lbs. (g)	Std. Pkg. Qty.
SGABM20-A-C	0.75 x 0.75 (19.1 x 19.1)	SGM, SGI	Nylon 6.6	White	Rubber	Indoor	.28 (127)	100
SGABM20-AT-C0			Weather Resistant Nylon 6.6	Black	Acrylic	Outdoor		
SGABM20-AV-C300	0.75 x 0.75 (19.1 x 19.1)	SGM, SGI	Heat Stabilized Weather Resistant Nylon 6.6		Black		High Bond Acrylic	
SGABM25-A-C	1.00 x 1.00 (25.4 x 25.4)	SGM, SGI, SGS	Nylon 6.6	White		Rubber	Indoor	
SGABM25-AT-C0			Weather Resistant Nylon 6.6	Black	Acrylic Adhesive	Outdoor		
SGABM25-AV-C300	1.00 x 1.00 (25.4 x 25.4)	SGM, SGI, SGS	Heat Stabilized Weather Resistant Nylon 6.6		Black		High Bond Acrylic	
SGABM30-AV-C300	1.12 x 1.12 (28.6 x 28.6)	SGM, SGI, SGS	Heat Stabilized Weather Resistant Nylon 6.6					

‡Cable tie cross section sizes: SGM = Super-Grip® Miniature, SGI = Super-Grip® Intermediate, and SGS = Super-Grip® Standard.

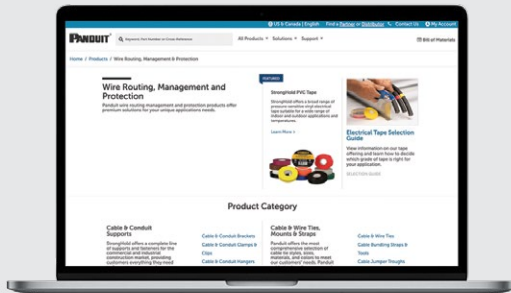

Like what you see? Want more?

Visit www.panduit.com for the full offering of Panduit products

www.panduit.com

< PREVIOUS PAGE | TABLE OF CONTENTS | NEXT PAGE >

UL[®] US Adhesive Backed Cord Clips



- UL 1565 per UL file E136577
- Continuous use temperature for rubber adhesive is -20°F (-29°C) to 120°F (49°C)
- Cables are easily snapped into or out of the clips

Part Number	L x W In. (mm)	Maximum Cable Diameter In. (mm)	Material	Color	Adhesive Base	Suitable Environment	Static Load Capacity lbs. (g)	Std. Pkg. Qty.
ACC19-A-C	0.76 x 0.63 (19.3 x 16.0)	.19 (4.8)	Nylon 6.6	Natural	Rubber	Indoor	0.2 (91)	100
ACC19-AT-M0			Weather Resistant Nylon 6.6	Black	Acrylic	Outdoor		1000
ACC38-A-C	1.00 x 1.00 (25.4 x 25.4)	.38 (9.6)	Nylon 6.6	Natural	Rubber	Indoor	.50 (227)	100
ACC38-A-M				Rubber				
ACC38-AV-M300*			Heat Stabilized Weather Resistant Nylon 6.6	Black	High Bond Acrylic	Outdoor	1.0 (454)	1000
ACC62-A-C	1.12 x 1.24 (28.5 x 31.4)	.62 (15.7)	Nylon 6.6	Natural	Rubber	Indoor	.69 (315)	100
ACC62-A-D								
ACC62-AV-D300			Heat Stabilized Weather Resistant Nylon 6.6	Black	High Bond Acrylic	Outdoor	1.38 (630)	500

*Not UL recognized

BEST SELLER

BEST SELLER

UL[®] US "J" Clip

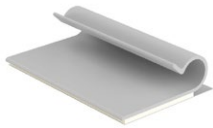

- Low profile clips retain cords, cables, or tubing
- Flexible design allows for easy cord insertion, yet holds bundle tightly
- For indoor use only
- Material: PVC

Part Number	Max Bundle Diameter		Length A		Width B		Height C		Diameter		Color	Adhesive Type	Std. Pkg. Qty.
	In.	mm	In.	mm	In.	mm	In.	mm	In.	mm			
AJC25-A-C	0.25	6.4	1.50	38.1	0.97	24.6	0.31	7.9	0.23	5.8	Light Gray	Rubber Adhesive Tape	100

Metal Adhesive Backed Cord Clip



- Can be opened and closed without damaging clip in order to remove or add cables quickly and easily
- For indoor use only

Part Number	Max Bundle Diameter		Length A		Width B		Clip Width C		Material	Adhesive Type	Std. Pkg. Qty.
	In.	mm	In.	mm	In.	mm	In.	mm			
MACC25-A-C	0.25	6.4	0.77	19.6	0.54	13.7	0.29	7.4	Zinc Plated Steel	Rubber	100
MACC25-A-D											500
MACC62-A-D	0.62	15.7	1.18	30.0	0.78	19.7				Rubber Adhesive	

PA US Latching Wire Clips

- Route and secure cords and cables
- Convenient releasable latch
- Available in six sizes with releasable latch

- Push barb parts are for use with a max panel thickness of 0.11" (2.7mm) and a hole diameter of 0.22" (5.6mm)
- For indoor use only
- Material: Nylon 6.6

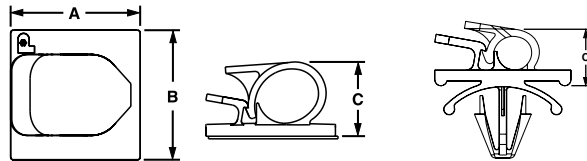

Adhesive Backed

Part Number	Max Bundle Diameter		Length		Width		Height		Color	Mounting Method	Std. Pkg. Qty.	
	In.	mm	In.	mm	In.	mm	In.	mm				
LWC25-A-C	0.25	6.4	0.88	22.2	1.00	25.4	0.45	11.4	Natural	Rubber Adhesive	100	
LWC25-A-C14									Gray			
LWC38-A-C14	0.38	9.5	1.00	25.4			0.56	14.2	Black			
LWC38-A-C20									Natural			
LWC50-A-L	0.50	12.7	1.26	32.0			0.67	17.0	Black			50
LWC50-A-L20									Natural			

Push Mount

Part Number	Max. Bundle Diameter		Length		Width		Height		Color	Mounting Method	Std. Pkg. Qty.
	In.	mm	In.	mm	In.	mm	In.	mm			
LWC75-H25-L14	0.75	19.1	1.45	36.8	0.87	22.1	0.97	24.7	Gray	Push Barb	50

PA US Bevel Entry Clips

- Beveled entry allows for easy insertion of cable bundle

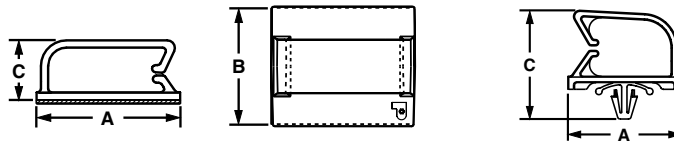
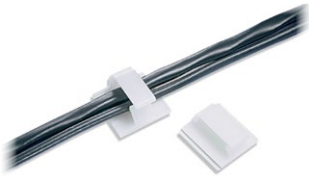

Adhesive Backed

Part Number	Max Bundle Diameter		Length (A)		Width (B)		Height (C)		Material	Color	Environment	Mounting Method	Std. Pkg. Qty.
	In.	mm	In.	mm	In.	mm	In.	mm					
BEC38-A-L	0.38	9.6	1.46	37.1	1.24	31.5	0.52	13.2	Nylon 6.6	Natural	Indoor	Rubber Adhesive	50
BEC62-A-T	0.62	15.7					0.79	20.1					200
BEC75-A-T	0.75	19.0					1.49	37.8					0.89

Adhesive Backed Latching Clips

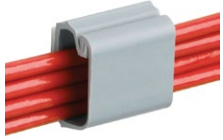

- Latching cover withstands vibration
- For indoor use only

Part Number	Max. Bundle Diameter		Length (A)		Width (B)		Height (C)		Material	Color	Adhesive Type	Std. Pkg. Qty.
	In.	mm	In.	mm	In.	mm	In.	mm				
LC3-A-C8	0.20	5.0	0.75	19.1	0.78	19.8	0.47	11.9	PVC	Light Gray	Rubber	100
LC5-A-C8	0.36	9.1	1.00	25.4	1.01	25.7	0.61	15.5				
LC10-A-L8	0.93	23.6	1.51	38.4	1.51	38.4	0.84	21.3				50

Latching Flat Cable Mounts

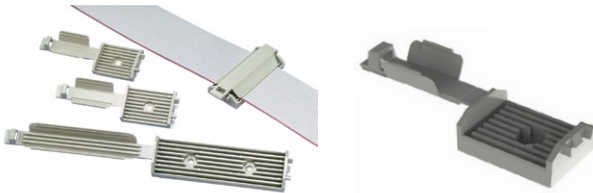

- Available in four sizes with a stack height of 0.17 inches (4.3mm) to accommodate different flat cable widths
- Low profile design holds wires, cables, and tubing
- Convenient releasable latch
- Large mounting base for high bonding strength
- For indoor use only
- Material: Nylon 6.6

Adhesive Backed

Part Number	Cable Width		Length A		Width B		Hole Spacing C		Color	Mounting Method	Std. Pkg. Qty.
	In.	mm	In.	mm	In.	mm	In.	mm			
FCM1-A-C14	1.05	26.7	2.90	73.7	1.05	26.7	—	—	Gray	Rubber Adhesive	100
FCM1.2-A-C14	1.20	30.5	3.16	80.3	1.37	34.8	—	—			
FCM2-A-C14	2.05	52.1	5.06	128.5	2.22	56.4	1.53	38.9			

Screw Mounted

Part Number	Max. Bundle Diameter		Length		Width		Height		Color	Mounting Method	Std. Pkg. Qty.
	In.	mm	In.	mm	In.	mm	In.	mm			
FCM1.2-S6-C14	1.20	30.5	3.16	80.3	1.00	25.4	—	—	Gray	#6 (M3) Screw	100

Flat Cable Clip

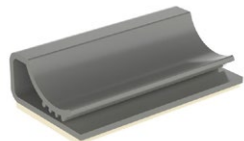

- Use with any width flat cable for a maximum stack height of 0.17 inches (4.3mm)
- Low profile design holds wires, cables, and tubing
- For indoor use only
- Material: PVC

Part Number	Cable Width	Length A		Width B		Height C		Color	Mounting Method	Std. Pkg. Qty.
		In.	mm	In.	mm	In.	mm			
FCC-A-C8	Any Width Flat Cable	1.00	25.4	1.09	27.7	0.38	9.7	Gray	Rubber	100

Metal Solar Edge Clips



MEC100-2PV-C



MEC125-4PV-C

- These clips are easy to install and provide installation efficiency in the field, no tools required
- Made of Stainless Steel, these clips offer a robust solution that can withstand the UV environment
- Good solution for managing PV wires in Solar Arrays; they clip and hold on Solar Frames

Metal Edge Clips that are oriented to route wires Parallel to outer edge of the Panel

Part Number	Panel Thickness	Recommended for use with 1000V Solar Wires	Certification to cULus (UL 1565)	Std. Pkg. Qty.
MEC100-2PV-C	.051" – .098" (1.3 – 2.5 mm)	1 to 2 PV Wires 10 Gauge (6mm ²)	Yes	100
MEC125-4PV-C	.051" – .125" (1.3 – 3.2mm)	1 to 4 PV Wires, 12 – 10 Gauge (4 – 6mm ²)	No	



MEC100-90-PV-C



MEC100-90-2PV-C

Metal Edge Clips that are oriented to route wires Perpendicular to outer edge of the Panel

Part Number	Panel Thickness	Recommended for use with 1000V Solar Wires	Certification to cULus (UL 1565)	Std. Pkg. Qty.
MEC100-90-PV-C	.051" – .098" (1.3 – 2.5mm)	1 to 2 PV Wires 12 Gauge (4mm ²), or USE-2 Wires	Yes	100
MEC100-90-2PV-C	.051" – .098" (1.3 – 2.5mm)	1 to 2 PV Wires 10 Gauge (6mm ²)	Yes	

Harness Clips



- Integral "spring" holds wire bundles tightly
- Available in vertical and horizontal loading configurations
- Design of wing provides added stability

Part Number	Max. Bundle Diameter Range		Max. Panel Thickness		Panel Hole Diameter		Material	Color	Mounting Method	Std. Pkg. Qty.
	In.	mm	In.	mm	In.	mm				
HCMP06B12-M20	0.24 – 0.47	6 – 12	0.118	3.0	0.28	7.2	Nylon 6.6	Black	Push Mount	100

Quick-Build™ Harness Board System

A Revolutionary Modular Solution for Harness Manufacturers

The modular, reusable solution consists of 1' X 1' (305mm x 305mm) grid tiles and specially designed, repositionable accessories that improve the productivity of wire harness assembly builds by up to 18%. The Quick-Build™ Accessories are more effective than nail, magnetic, or snap-in routing fixture methods. Accessories easily twist and lock in place until you're ready to make a change for faster routing of wires and design flexibility.

Low-Volume-High-Mix (LVHM) manufacturers achieve the greatest savings due to reduced material costs — up to 65% of layout and board builds. By reducing the number of bulky plywood boards, the Quick-Build™ Harness Board System delivers more than 50% in storage space savings. Whether you need to build a variety of wire and cable assemblies to meet different customer specifications or for prototyping new harness designs, the more you build, the greater your profitability.

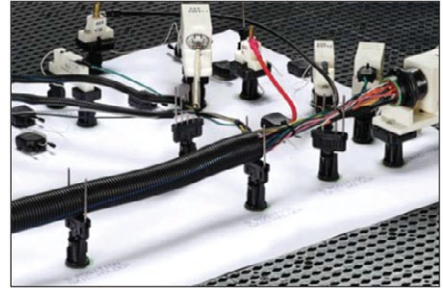

Quick-Build™ Starter Kit



- Kit of Quick-Build™ components and various harness board accessories allows customers to evaluate the Quick-Build™ solution by simply ordering a single part number

Part Number	Description	Std. Pkg. Qty.
QB-KIT2	Starter Kit assortment that includes our core Quick-Build™ Components essential for faster wire harness builds. Black.	1

Quick-Build™ Grid Tile



- Install on top of plywood backing to provide mounting surface
- Secure to plywood with user supplied screws

Part Number	Description	Std. Pkg. Qty.
QB-TILE	1' X 1' (305mm x 305mm) square base component that allows Quick-Build™ mounting pegs and platforms to create a modular harness system. One package includes 8 tiles. Black.	1

Quick-Build™ Mounting Peg



- Repositionable to allow user to build different harness configurations as needed
- Pointed end inserts through drawing secured to grid tiles, providing the ability to create a harness on top of a drawing

Part Number	Description	Std. Pkg. Qty.
QB-MOUNT-L	Peg can be positioned and relocated. Accepts single nail holders, five nail holders, and Quick-Build™ mounting platforms. Allows accessories to rotate as needed even after mounting peg is installed into grid tile. Black.	50

Note: Required for use with Quick-Build™ mounting platform and Quick-Build™ nail holders to provide a modular harness board system

Traditional Harness Board Accessories

Panduit harness board accessories have been around for a long time and continue to provide easy routing and forming of wires in harness fabrication.

Harness Board Nail



- Manufactured from Nickel Plated Steel
- Smooth finish on nails prevents abrasion to wire jackets

Part Number	Description	Compatible QB Components	Std. Pkg. Qty.
HBN2-T	Harness Board Nail – 2" long (2.66" overall)	QB-SN2-Q and QB-FN2-Q	200

Elastic Retainers – Replaceable Version

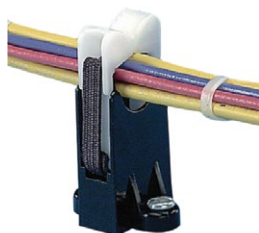

- Cable bundles are formed as individual wires are inserted
- Completed bundles can be easily removed
- The elastic band is replaceable

Part Number	Description	Compatible QB Components	Std. Pkg. Qty.
RER.5-S6-X	Elastic retainer with replaceable elastic band Suitable for 0.5" maximum bundle capacity.	QB-BASE175-Q and QB-S6-500-C	10
RER.75-S6-X	Elastic retainer with replaceable elastic band. Suitable for 0.75" maximum bundle capacity.		
RER1.25-S6-X	Elastic retainer with replaceable elastic band. Suitable for 1.25" maximum bundle capacity.		

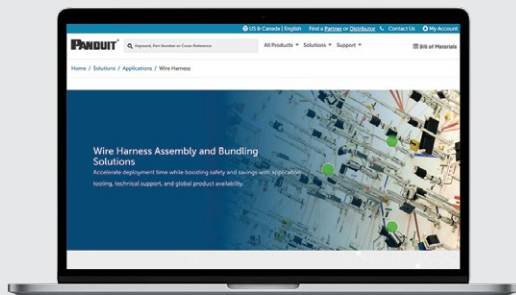

**Like what you see?
Want more?**

Visit www.panduit.com for the full offering of Panduit products

www.panduit.com

Panduit Manual Cable Tie Installation Tools

Panduit provides the most preferred hand-operated tools in the industry. They promote worker safety, help reduce downtime, improve productivity and provide the lowest total installed cost. Our offering of versatile tools can be used for production, maintenance, or construction applications. For more information on the full Panduit Cable Tie Installation Tools line, visit: www.panduit.com.



- Tool controlled tension provides flush cut-off and speeds
- Lightweight and balanced ergonomic design
- Excellent tools for low to medium volume applications
- Easy to change tension adjustment and easy to operate
- QPL per Mil. Std. SAE AS81306 and Mil. Spec. SAE AS90387

BEST SELLER

BEST SELLER

BEST SELLER

Part number	Installs Cable Tie Cross Sections	Weight oz (g)	Body Construction	Color	Mil Spec Number	Std. Pkg. Qty.
GTS-E	SM, M, I, S	10.4 (294)	Impact Resistant Plastic Resin	Body: Dark Gray Handle/Gripper: Black Tension Knob: Black	MS90387-1	1
GS2B-E		13.6 (385)	Metal	Body: Light Gray Handle/Gripper: Black Tension Knob: Black	MS90387-1	
GTH-E	S, HS, LH, H	11.9 (337)	Impact Resistant Plastic Resin	Body: Dark Gray Handle/Gripper: Red Tension Knob: Red	MS90387-2	
GS4H-E		15.3 (435)	Metal	Body: Light Gray Handle/Gripper: Red Tension Knob: Red	MS90387-2	

Cable tie cross section sizes: SM = Subminiature, M = Miniature, I = Intermediate, S = Standard LH = Light-Heavy, H = Heavy

Pneumatic Cable Tie Hand Tools



Part number	Installs Cable Tie Cross Sections	Description	Std. Pkg. Qty.
PTS	Subminiature, Miniature, Intermediate, Standard	Pneumatic hand tool with ergonomic design. Impact resistant resin housing. Color identification: Black trigger, handle, label and tension selector knob.	1
PTH	Standard, Heavy-Standard, Light-Heavy, Heavy	Pneumatic hand tool with ergonomic design. Impact resistant resin housing. Color identification: Red trigger, handle, label and tension selector knob.	
PPTS	Standard, Heavy-Standard, Light-Heavy, Heavy	Pneumatic hand tool. Metal housing. Color identification: Black trigger, label and tension selector knob. This tool is field serviceable. Replacement part kits can be part of a scheduled maintenance program.	

Panduit Automatic Cable Tie Installation Systems

The complete line of Panduit automatic cable tie installation systems offers a superior solution for high volume harness, assembly, fastening and packaging applications. These ergonomic systems increase productivity, provide consistent performance, and reduce activities that lead to repetitive motion injuries. For more information on the full Panduit Cable Tie Installation Systems line, visit: www.panduit.com.



Tool Heads

- Durable, one-piece cable tie tip collector
- Includes tension adjustment
- Right or left hand operation
- Built-in safety interlock prevents false triggering if anything obstructs jaw path

Part Number	Max Bundle Diameter		Dispenser	Transfer Hose	Used with Cable Ties	Std. Pkg. Qty.
	In.	mm				
BEST SELLER PAT1M4.0	0.82	21	PDM4.0	PHM1, PHM2, PHM3, PHM4	PLT1M-XMR	1
BEST SELLER PAT1.5M4.0	1.31	33			PLT1.5M-XMR	



Dispensers

- Microprocessor based controller monitors system performance through a touch screen display. Provides production data and reporting, including error detection and cycle count for improved reliability
- Online HELP menu through LCD display in seven languages (English, Spanish, German, Italian, French, Czech, Japanese), is user-friendly for quick and simple training.

Part Number	Used with Tool Head	Description	Std. Pkg. Qty.
BEST SELLER PDM4.0	PAT1M4.0, PAT1.5M4.0, PAT1M4.0-BT, PAT1.5M4.0-BT	Stationary dispenser with electronic display. Online help menu. System operates on 65 psig (minimum) non-lubricated filtered air and 100 – 24 FAC/TP or 60 MHz.	1

Transfer Hose



Part number	Used with Tool Head	Description	Length		Std. Pkg. Qty.
			ft	m	
PHM3	PAT1M4.0 PAT1.5M4.0 PAT1M4.0-BT PAT1.5M4.0-BT	Transfers cable tie and signal from dispenser to tool head; electrical connectors designed for easy attachment provide a reliable, secure connection.	10.0	3	1

PLT-XMR Reel-Fed Cable Ties

Panduit provides the most preferred hand-operated tools in the industry. They promote worker safety, help reduce downtime, improve productivity and provide the lowest total installed cost. Our offering of versatile tools can be used for production, maintenance, or construction applications. For more information on the full Panduit Cable Tie Installation Systems line, visit: www.panduit.com.

- Continuous feeding allows for high productivity and reduced downtime



	Part number	Material	Color	For Use With PAT4.0 Tool Head	Max Bundle Diameter In. (mm)	Length In. (mm)	Width In. (mm)	Min Loop Tensile Strength lbs (N)	AH-2 Plenum Rated	Continuous Use Temperature Rating
BEST SELLER	PLT1M-XMR	Nylon 6.6	Natural	PAT1M4.0	.82 (21)	4.0 (102)	0.10 (2.5)	18 (80)	Yes	-76° F (-60° C) to 185° F (85° C)
BEST SELLER	PLT1M-XMR0	Weather Resistant Nylon 6.6	Black							
	PLT1M-XMR00*	Resistant Nylon 6.6								
	PLT1M-XMR30	Heat Stabilized Nylon 6.6						No	-76 F (-60 C) to 239 F (115 C)	
BEST SELLER	PLT1.5M-XMR	Nylon 6.6	Natural	PAT1.5M4.0	1.31 (33)	5.6 (142)			Yes	-76° F (-60° C) to 185° F (85° C)
BEST SELLER	PLT1.5M-XMR0	Weather Resistant Nylon 6.6	Black							
BEST SELLER	PLT1.5M-XMR30	Heat Stabilized Nylon 6.6								

*Military grade weather resistant material.

Note: PLT_XMR cable ties (natural, 00, and colors) are Class 2 Mil. Spec. per AS23190 and AS33671.

Please visit www.panduit.com for additional colors

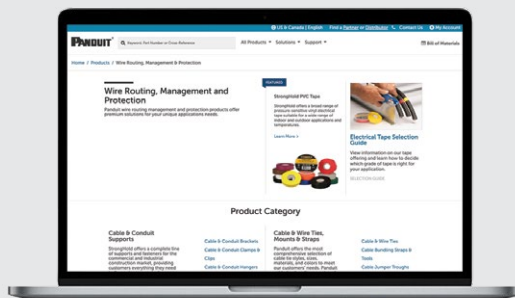

Like what you see? Want more?

Visit www.panduit.com for the full offering of Panduit products

www.panduit.com



PLT-VMR Reel-Fed Cable Ties

- Continuously molded cable ties (2,500 ties/reel) provide continuous feeding for high productivity and reduced downtime due to fewer reel changes



- All-nylon, one-piece locking ties with 50 lbs. minimum loop tensile strength in standard cross section for larger bundles up to 1.94" (49mm) diameter
- Reel-fed cable ties in Nylon 6.6 material (Natural color) are UL Listed for use in plenum or air handling spaces per NEC

Reel-Fed Cable Ties for PAT2S System

Part number	Material	Color	Max Bundle Diameter In. (mm)	Length In. (mm)	Width In. (mm)	Min Loop Tensile Strength lbs. (N)	AH-2 Plenum Rated	Continuous Use Temperature Rating
PLT2S-VMR	Nylon 6.6	Natural	1.94 (49)	8.1 (206)	0.190 (4.8)	50 (222)	Yes	-76° F (-60° C) to 185° F (85° C)
PLT2S-VMR0	Weather Resistant Nylon 6.6	Black						
PLT2S-VMR30	Heat Stabilized Nylon 6.6						No	-76° F (-60° C) to 239° F (115° C)

Note: PLT-VMR Nylon 6.6 cable ties are Class 2 Mil. Spec. per AS23190 and AS33671.



BT-XMR Reel-Fed Cable Ties

- Continuously molded cable ties (5,000 ties/reel) provide continuous feeding for high productivity and reduced downtime due to fewer reel changes



BT-XMR



BT_XMR (0, 30)

- Reel-fed cable ties with exclusive stainless steel locking barb and 30 lbs. minimum loop tensile strength permit higher tension for demanding applications
- Metal locking barb and tie body design provide greater bundle tightness, reducing both rotational and lateral movement of the tie
- Reel-fed cable ties in Nylon 6.6 material (Natural color) are UL Listed for use in plenum or air handling spaces per NEC

Part number	Material	Color	For Use With PAT4.0-BT Tool Head	Max Bundle Diameter In. (mm)	Length In. (mm)	Width In. (mm)	Min Loop Tensile Strength lbs. (N)	AH-2 Plenum Rated	Continuous Use Temperature Rating
BT1M-XMR	Nylon 6.6	Natural	PAT1M4.0-BT	0.82 (21)	4.0 (102)	0.190 (4.8)	30 (133)	Yes	-76° F (-60° C) to 185° F (85° C)
BT1M-XMR0	Weather Resistant Nylon 6.6	Black				0.190 (4.8)			
BT1M-XMR30	Heat Stabilized Nylon 6.6					No		-76° F (-60° C) to 239° F (115° C)	
BT1.5M-XMR	Nylon 6.6	Natural	PAT1.5M4.0-BT	1.31 (33)	5.6 (142)	0.100 (2.5)	Yes	-76° F (-60° C) to 185° F (85° C)	
BT1.5M-XMR30	Heat Stabilized Nylon 6.6	Black				No			-76° F (-60° C) to 239° F (115° C)

PXE™ Series MP300 Mobile Printer

Do your job smarter, faster and easier with PXE Series Mobile Printers. This full line of advanced identification printers combine Panduit's industry-leading performance and field-tested durability with Epson's world-class printing technology.



MP300

- 360 dpi print resolution
- Automatic cutter with full or half cut – saves time and effort for everyday labeling
- Fast 1.4-inch per second print speed – maximize your productivity and lower your installation costs
- Up to 1.5-inch wide label sizes
- Prints die-cut and continuous labels – choose from a wide variety of labeling materials
- USB connectivity
- Prints from Easy-Mark Plus™ Labeling Software
- Includes magnetic attachment accessory
- Includes rechargeable Li-ion battery pack

BEST SELLER

Part Number	Description
MP300	Includes MP300 printer, one (1) cassette of S100X150VAM self-laminating labels, rechargeable Li-ion Battery Pack, hard carrying case, AC power adapter, USB cable, magnetic attachments and quick reference card
MP300-ACS	MP300-ACS Replacement 120-240 VAC universal power adapter module with power cord for North America for MP300 printer
MP-BATT	Replacement Li-ion rechargeable battery pack for MP200 and MP300 printers
MP-CASE	Replacement hard carrying case for MP200 and MP300 printers
PTR-CLN	Printer cleaning kit - contains (1) cleaning pen, (8) cleaning solution soaked wipes, (8) foam swabs pre-saturated with cleaning solution, MSDS, and cleaning instructions

PXE™ Series MP200 and MP200-KIT Mobile Printers

- Shared MP Cassette Platform
- 180 dpi print resolution
- Automatic cutter with full or half cut
- Fast 1.2-inch per second print speed
- Up to 1.0-inch wide continuous label media
- USB connectivity
- Prints from Easy-Mark Plus™ Labeling Software
- Application specific label modes



MP200



MP200-KIT

Part Number	Description
MP200	Rugged, high performance, economical industrial printer that features a large LCD backlit screen, custom label modes, barcodes and symbols, includes the printer, continuous label cassette, and quick reference card
MP200-KIT	Rugged, high performance, economical industrial printer that features a large LCD backlit screen, custom label modes, barcodes and symbols. Includes the printer, a continuous label cassette, hard carrying case, rechargeable battery pack, magnetic feet, USB cable, and power adapter
MP-CASE	Replacement hard carrying case for MP200 and MP300 printers
MP-BATT	Replacement Li-ion rechargeable battery pack for MP200 and MP300 printers
MP-ACS-1	ACS replacement 120-240 VAC universal power adapter module with power cord for North America for MP100, MP200, and MP200-KIT printers
PTR-CLN	Printer cleaning kit - contains (1) cleaning pen, (8) cleaning solution soaked wipes, (8) foam swabs pre-saturated with cleaning solution, MSDS, and cleaning instructions

www.panduit.com

PXE™ Series MP100 Mobile Printer



MP100

- Automatic cutter
- USB and Bluetooth Connectivity
- Integration with Fluke LinkWare™ Live
- Prints from Easy-Mark Plus™ Labeling Software
- Up to 1.0-inch wide continuous label sizes
- Prints from mobile labeling apps
- Compact size

Part Number	Description
MP100	Includes MP100 printer, protective impact bumper, 1 cassette of T100X000VPM-BK continuous vinyl tape, AC power adapter, USB cable, and quick reference card
MP-ACS-1	Replacement 120-240 VAC universal power adapter module with power cord for North America for MP100 and MP200 printers
MP100-IB	Replacement impact bumper for MP100 and MP100/E printers
PTR-CLN	Printer cleaning kit - contains (1) cleaning pen, (8) cleaning solution soaked wipes, (8) foam swabs pre-saturated with cleaning solution, MSDS, and cleaning instructions

PXE™ Series MP75 Mobile Printer



MP75

- 180 dpi print resolution
- Fast 0.25-inch per second print speed
- Up to 0.75-inch wide continuous label media
- Manual Push Button Cutter
- Application specific label modes

Part Number	Description
MP75	Compact entry level industrial printer that features custom label modes, a qwerty keyboard, backlit LCD screen, and a large library of barcodes and custom symbols. Includes the lightweight printer, a continuous label cassette, and quick reference card
PTR-CLN	Printer cleaning kit - contains (1) cleaning pen, (8) cleaning solution soaked wipes, (8) foam swabs pre-saturated with cleaning solution, MSDS, and cleaning instructions

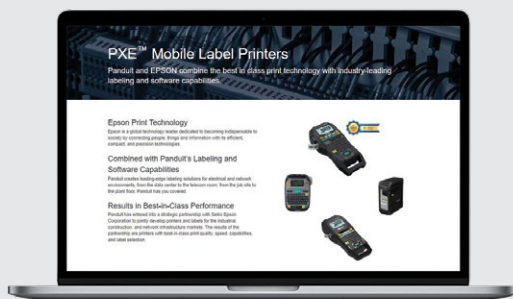

**Like what you see?
Want more?**

Visit panduit.com/mobileprinters for the full offering of Panduit products

Turn-Tell® Label Cassettes **PATENTED**



- Fast-loading label cassette includes both label material and ribbon to make changing labels easy
- Innovative label design allows labels to rotate for visibility from any angle, and for repositioning on the wire/cable to align legends and improve aesthetics
- Labels can be easily installed on existing terminated wires and assemblies without disconnecting the wires/cables
- Print-On Area Color: Black on White



Polymer Film (V1)



-40°F to 150°F (-40°C to 66°C)

Part Number	Description	Quantity of Labels per Cassette	Printer Compatibility				Width		Length		Std. Pkg. Qty.	Std. Ctn. Qty.
			MP75	MP100	MP200	MP300	In.	mm	In.	mm		
R100X075V1M	MP Cassette, Turn-Tell Self-Laminating Label, Vinyl, 1.00" W x 0.75" H, 0.25" Print On Area	175							0.75	19.1		
R100X125V1M	MP Cassette, Turn-Tell Self-Laminating Label, Vinyl, 1.00" W x 1.25" H, 0.38" Print On Area	125							1.25	31.8		
R100X150V1M	MP Cassette, Turn-Tell Self-Laminating Label, Vinyl, 1.00" W x 1.5" H, 0.5" Print On Area	100	N	N	N	Y	1.00	25.4	1.5	38.1	1	5
R100X225V1M	MP Cassette, Turn-Tell Self-Laminating Label, Vinyl, 1.00" W x 2.25" H, 0.75" Print On Area	75							2.25	57.2		

BEST SELLER

Continuous Self-Laminating Label Cassettes



- Fast-loading label cassette includes both label material and ribbon to make changing labels easy
- Self-laminating adhesive labels for wire/cable identification include a white print-on area and clear overlaminates
- Print-On Area Color: Black on White



Self-Laminating Vinyl (VA)



-40°F to 150°F (-40°C to 66°C)

Part Number	Description	Printer Compatibility				Width		Length		Print-On Area Height		Min. Cable O.D.		Max. Cable O.D.		Wire/Cable Size Range	Std. Pkg. Qty.	Std. Ctn. Qty.	
		MP 75	MP 100	MP 200	MP 300	In.	mm	In.	mm	In.	mm	In.	mm	In.	mm				
S000X100VAM	MP Cassette, Continuous Self-Laminating Tape, Vinyl, 1.0" W x 26' L		Y	Y		0.945	24.0			0.315	8	0.10	2.5	0.20	5.1	12 – 10 AWG			
S000X150VAM	MP Cassette, Continuous Self-Lam Tape, Vinyl, 1.5" W x 26' L, White	N			Y	1.417	36.0		26.2	8.0	0.512	13.0	0.16	4.0	0.32	8.1	Cat. 5e/ Cat. 6	1	5

www.panduit.com

Die-Cut Self-Laminating Label Cassettes



- Fast-loading label cassette includes both label material and ribbon to make changing labels easy
- Self-laminating adhesive labels for wire/cable identification includes a white print-on area and clear over laminate
- Print-On Area Color: Black on White

 Self-Laminating Vinyl (VA)

 -40°F to 150°F (-40°C to 66°C)

Part Number	Description	Quantity of Labels Per Cassette	Printer Compatibility				Width		Length		Print-On Area Height		Min. Cable O.D.		Max. Cable O.D.		Wire/Cable Size Range	Std. Pkg. Qty.	Std. Ctn. Qty.
			MP 75	MP 100	MP 200	MP 300	In.	mm	In.	mm	In.	mm	In.	mm	In.	mm			
S050X075VAM	MP Cassette, Self-Laminating Label, Vinyl, 0.50" W x 0.75" H, 0.25" Print On Area	425						0.75	19.1	0.25	6.4	0.08	2.0	0.16	4.0	18 – 14 AWG			
S050X125VAM	MP Cassette, Self-Laminating Label, Vinyl, 0.50" W x 1.25" H, 0.38" Print On Area	200					0.50	12.7	1.25	31.8	0.38	9.7	0.12	3.1	0.28	7.0	12 – 10 AWG		
S050X150VAM	MP Cassette, Self-Laminating Label, Vinyl, 0.50" W x 1.50" H, 0.50" Print On Area	175							1.50	38.1	0.50	12.7	0.16	4.0	0.32	8.1	Cat. 5e/ Cat. 6		
S100X075VAM	MP Cassette, Self-Laminating Label, Vinyl, 1.00" W x 0.75" H, 0.25" Print On Area	300							0.75	19.1	0.25	6.4	0.08	2.0	0.16	4.0	18 – 14 AWG		
S100X125VAM	MP Cassette, Self-Laminating Label, Vinyl, 1.00" W x 1.25" H, 0.38" Print On Area	200	N	N	N	Y			1.25	31.8	0.38	9.7	0.12	3.1	0.28	7.0	12 – 10 AWG	1	5
BEST SELLER S100X150VAM	MP Cassette, Self-Laminating Label, Vinyl, 1.00" W x 1.50" H, 0.50" Print On Area	175							1.50	38.1	0.50	12.7	0.16	4.0	0.32	8.1	Cat. 5e/ Cat. 6		
S100X225VAM	MP Cassette, Self-Laminating Label, Vinyl, 1.00" W x 2.25" H, 0.75" Print On Area	125					1.00	25.4	2.25	57.2	0.75	19.1	0.24	6.1	0.48	12.2	8 – 4 AWG		
S100X400VAM	MP Cassette, Self-Laminating Label, Vinyl, 1.00" W x 4.00" H, 1.00" Print On Area	70							4.00	101.6	1.00	25.4	0.32	8.1	0.95	24.3	2 – 1 AWG		
S100X650VAM	MP Cassette, Self-Laminating Label, Vinyl, 1.00" W x 6.50" H, 1.50" Print On Area	45							6.50	165.1	1.50	38.1	0.48	12.2	1.59	40.4	1/0-250 MCM		

www.panduit.com

Continuous Heat Shrink Label Cassettes



- Fast-loading label cassette includes both label material and ribbon to make changing labels easy
- Shrink ratio 3:1
- Non-adhesive flattened heat shrinkable polyolefin for wire/cable identification

Heat Shrinkable Polyolefin (H1, H2, HP, HX)

H1, H2: -40°F to 257°F (-40°C to 125°C)
 HP, HX: -67°F to 257°F (-55°C to 125°C)

Part Number	Description	Shrink Ratio	Mil Spec	Printer Compatibility				Ribbon & Material Color	Width		Length		Min. Cable O.D.		Max. Cable O.D.		Wire/Cable Size Range	Std. Pkg. Qty.	Std. Ctn. Qty.					
				MP 75	MP 100	MP 200	MP 300		In.	mm	In.	mm	In.	mm	In.	mm								
H000X025H1M	MP Cassette, Continuous Heat Shrink Tubing, Mil Grade Polyolefin, 0.25" W x 8' L	3:1	Y	Y				Black on White	0.27	6.8	8.2	2.5	0.06	1.4	0.16	4.1	22 – 18 AWG	1	5					
H000X025H2M	MP Cassette, Continuous Heat Shrink Tubing, Mil Grade Polyolefin, 0.25" W x 8' L							Black on Yellow																
H000X034H1M	MP Cassette, Continuous Heat Shrink Tubing, Mil Grade Polyolefin, 0.34" W x 8' L							Black on White																
H000X034H2M	MP Cassette, Continuous Heat Shrink Tubing, Mil Grade Polyolefin, 0.34" W x 8' L							Black on Yellow																
H000X044H1M	MP Cassette, Continuous Heat Shrink Tubing, Mil Grade Polyolefin, 0.44" W x 8' L	3:1	Y	Y				Black on White	0.48	12.3	8.2	2.5	0.09	2.4	0.30	7.6	16 – 8 AWG	1	5					
H000X044H2M	MP Cassette, Continuous Heat Shrink Tubing, Mil Grade Polyolefin, 0.44" W x 8' L							Black on Yellow																
H000X064HPM	MP Cassette, 2:1 Continuous Heat Shrink Tubing, Polyolefin, 0.64" W x 8.0' L, White	2:1	N	N				Black on White	0.71	18			8.2	2.5	0.21	5.3				0.43	10.9	8 – 2 AWG	1	5
H000X064HXM	MP Cassette, 2:1 Continuous Heat Shrink Tubing, Polyolefin, 0.64" W x 8.0' L, Yellow							Black on Yellow																
H000X084HPM	MP Cassette, 2:1 Continuous Heat Shrink Tubing, Polyolefin, 0.84" W x 8.0' L, White							Black on White																
H000X084HXM	MP Cassette, 2:1 Continuous Heat Shrink Tubing, Polyolefin, 0.84" W x 8.0' L, Yellow							Black on Yellow																
H000X134HPM	MP Cassette, 2:1 Continuous Heat Shrink Tubing, Polyolefin, 1.34" W x 8.0' L, White	2:1	N	N				Black on White	1.34	34	8.2	2.5	0.43	10.9	0.79	20.1	1 – 250 MCM AWG	1	5					
H000X134HXM	MP Cassette, 2:1 Continuous Heat Shrink Tubing, Polyolefin, 1.34" W x 8.0' L, Yellow							Black on Yellow																

www.panduit.com

Continuous Tape Cassettes



- Fast-loading Label Cassette includes both label material and ribbon to make changing labels easy
- Print custom pipe markers, voltage markers, signs, bin markers, and network identification labels on demand
- For flat label applications only

Vinyl Material (VXM & VPM):
-40°F to 194°F (-40°C to 90°C)

Polyester Material (YKM):
-40°F to 302°F (-40°C to 150°C)

Magnetic Material (MPM & MXM):
14°F to 104°F (-10°C to 40°C)

Part Number	Description	Printer Compatibility				Ribbon & Material Color	Width		Length		Std. Pkg. Qty.	Std. Ctn. Qty.
		MP 75	MP 100	MP 200	MP 300		In.	mm	Ft.	m		
T038X000VPM-BK	MP Cassette, Continuous Tape, Vinyl, 0.38" W x 23' L					Black on White						
T038X000VXM-BK	MP Cassette, Continuous Tape, Vinyl, 0.38" W x 23' L					Black on Yellow	0.354	9.0	23	7.0		
T038X000YKM-BK	MP Cassette, Continuous Tape, Polyester, 0.38" W x 30' L					Black on Clear			30	9.1		
T050X000VPM-BK	MP Cassette, Continuous Tape, Vinyl, 0.50" W x 23' L					Black on White			23	7.0		
T050X000VXM-BK	MP Cassette, Continuous Tape, Vinyl, 0.50" W x 23' L	Y				Black on Yellow	0.472	12.0				
T050X000YKM-BK	MP Cassette, Continuous Tape, Polyester, 0.50" W x 30' L					Black on Clear			30	9.1		
T075X000VPM-BK	MP Cassette, Continuous Tape, Vinyl, 0.75" W x 23' L					Black on White			23	7.0		
T075X000VXM-BK	MP Cassette, Continuous Tape, Vinyl, 0.75" W x 23' L		Y	Y		Black on Yellow	0.710	18.0				
T075X000YKM-BK	MP Cassette, Continuous Tape, Polyester, 0.75" W x 30' L					Black on Clear			30	9.1		
T100X000MPM-BK	MP Cassette, Continuous Tape, Magnetic, 1.00" W x 4.9' L				Y	Black on White			4.9	1.5	1	5
T100X000MXM-BK	MP Cassette, Continuous Tape, Magnetic, 1.00" W x 4.9' L					Black on Yellow						
BEST SELLER T100X000VPM-BK	MP Cassette, Continuous Tape, Vinyl, 1.00" W x 23' L					Black on White	0.945	24.0	23	7.0		
BEST SELLER T100X000VXM-BK	MP Cassette, Continuous Tape, Vinyl, 1.00" W x 23' L					Black on Yellow						
T100X000YKM-BK	MP Cassette, Continuous Tape, Polyester, 1.00" W x 30' L					Black on Clear			30	9.1		
T150X000MPM-BK	MP Cassette, Continuous Tape, Magnetic, 1.50" W x 4.9' L					Black on White			4.9	1.5		
T150X000MXM-BK	MP Cassette, Continuous Tape, Magnetic, 1.50" W x 4.9' L					Black on Yellow						
T150X000VPM-BK	MP Cassette, Continuous Tape, Vinyl, 1.50" W x 23' L					Black on White	1.471	36.0	23	7.0		
T150X000VXM-BK	MP Cassette, Continuous Tape, Vinyl, 1.50" W x 23' L		N	N		Black on Yellow						
T150X000YKM-BK	MP Cassette, Continuous Tape, Polyester, 1.50" W x 30' L					Black on Clear			30	9.1		

MP Nylon Cloth Continuous Tape Cassette Parts



- Fast-loading Label Cassette includes both label material and ribbon to make changing labels easy
- Non-laminated adhesive labels for wire/cable identification

Nylon Cloth (C1M)
 -65°F to 275°F (-54°C to 135°C)

Part Number	Description	Printer Compatibility				Print-On Area Color	Height		Length		Std. Pkg. Qty.	Std. Ctn. Qty.
		MP75	MP100	MP200	MP300		In.	mm	Ft.	m		
T050X000C1M-BK	MP Cassette, Continuous Tape, Nylon Cloth, 0.50" W x 19' L, Black on White	Y				Black on White	0.465	11.82			1	5
T075X000C1M-BK	MP Cassette, Continuous Tape, Nylon Cloth, 0.75" W x 19' L, Black on White		N	Y	Y		0.702	17.82	19	6		
T100X000C1M-BK	MP Cassette, Continuous Tape, Nylon Cloth, 1.00" W x 19' L, Black on White	N					0.938	23.82				

Non-Adhesive Polyester Component Labels



- Fast-loading Label Cassette includes both label material and ribbon to make changing labels easy
- Die-cut labels designed to provide maximum aesthetic quality and appearance
- Use for identifying patch panel, faceplates, punchdown blocks, and other network system hardware

Non-Adhesive Polyester (Y1)
 -10°F to 311°F (-23°C to 155°C)



Part Number	Description	Labels per Cassette	Printer Compatibility				Color	Width		Height		Application	Std. Pkg. Qty.	Std. Ctn. Qty.
			MP75	MP100	MP200	MP300		In.	mm	In.	mm			
C195X040Y1M	MP Cassette, Comp Label, Non-Adhesive Polyester, 1.95" W x .40" H, White	125	N	N	N	Y	White	1.95	49.5	0.4	10.2	Single-gang faceplate	1	5
C261X035Y1M	MP Cassette, Comp Label, Non-Adhesive Polyester, 2.61" W x .35" H, White	100						2.61	66.3	0.35	8.9	4-port		

Representative offering only, visit www.panduit.com for complete listing of products.

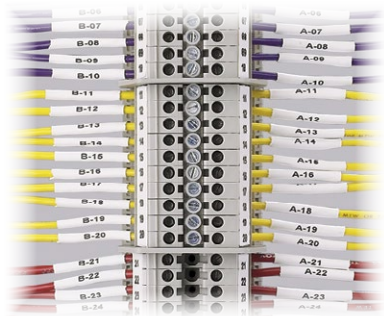
Continuous Terminal Block Label Cassettes



- Fast-loading Label Cassette includes both label material and ribbon to make changing labels easy
- Print terminal block labels ranging in size from 0.24 inches to 0.38 inches

 Polyolefin (FJM)
 -40°F to 180°F (-40°C to 82°C)

Part Number	Description	Printer Compatibility				Print-On Area Color	Height		Length		Std. Pkg. Qty.	Std. Ctn. Qty.
		MP75	MP100	MP200	MP300		In.	mm	Ft.	m		
T024X000FJM-BK	MP Cassette, Continuous Tape, Polyolefin, 0.24" W x 23' L, Black on White	Y	Y	Y	Y	Black on White	0.229	5.82	23	7	1	5
T038X000FJM-BK	MP Cassette, Continuous Tape, Polyolefin, 0.38" W x 23' L, Black on White						0.347	8.82				

Representative offering only, visit www.panduit.com for complete listing of products.

P1™ Turn-Tell® Label Cassettes for PanTher™ LS8E/LS8EQ Hand-Held Thermal Transfer Printers



- Fast loading P1™ Label Cassette includes both label material and ribbon to make changing labels easy
- Innovative label design allows labels to rotate for visibility from any angle, and for repositioning on the wire/cable to align legends and improve aesthetics
- Labels can be easily installed on existing terminated wires and assemblies without disconnecting the wires/cables
- Print-On Area Color: Black on White



 -40°F to 200°F (-40°C to 93°C)

Part Number	Width		Length		Print-On Area Height		Min. Cable O.D.		Max. Cable O.D.		Wire Range	Labels Per Cassette	Std. Pkg. Qty.	Std. Ctn. Qty.
	In.	mm	In.	mm	In.	mm	In.	mm	In.	mm				
R100X150V1C	1.00	25.4	1.50	38.1	0.50	12.7	0.22	5.6	0.28	7.1	Cat. 5e UTP/ Cat. 6 UTP/ Cat. 6A UTP/ Cat. 5e FTP/ 10 – 6 AWG	100	1	10
R100X225V1C			2.25	57.2	0.75	19.1	0.28	7.1	0.39	9.9				

www.panduit.com

P1™ Self-Laminating Label Cassettes for PanTher™ LS8E/LS8EQ Hand-Held Thermal Transfer Printer

- P1™ Label Cassette contains an integrated memory device for automatic formatting, recall of last legend used, and number of labels remaining in the cassette
- Fast loading label cassette includes both label material and ribbon to make changing labels easy
- Self-laminating adhesive labels for wire/cable identification include a colored print-on area and clear overlamine
- Labels are available in a large range of wire/cable sizes
- Print-On Area Color: Black on White

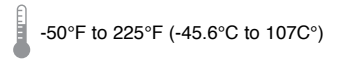

Part Number	Width		Length		Print-On Area Height		Min Cable O.D.		Max Cable O.D.		Wire Range	Labels Per Cassette	Std. Pkg. Qty.	Std. Ctn. Qty.
	In.	mm	In.	mm	In.	mm	In.	mm	In.	mm				
S050X075VAC	0.50	12.7	0.75	19.1	0.25	6.4	0.08	2.0	0.16	4.1	Cat. 6 28 AWG/18 – 14 AWG	450	1	10
S050X125VAC			1.25	31.8	0.38	9.7	0.12	3.1	0.28	7.0	Cat. 3 UTP/12 – 10 AWG	225		
S050X150VAC	0.75	19.1	1.50	38.1	0.50	12.7	0.16	4.1	0.32	8.1	Cat. 5e UTP/Cat. 6 UTP/ Cat. 6A UTP/Cat. 5e FTP/ 10 – 6 AWG	200		
S075X150VAC											Cat. 5e UTP/Cat. 6 UTP/ Cat. 6A UTP/Cat. 5e FTP/ 10 – 6 AWG			
S100X075VAC	1.00	25.4	0.75	19.1	0.25	6.4	0.08	2.0	0.16	4.1	Cat. 6 28 AWG/18 – 14 AWG	350		
S100X125VAC			1.25	31.8	0.38	9.7	0.12	3.1	0.28	7.1	Cat. 3 UTP/12 – 10 AWG	225		
S100X150VAC			1.50	38.1	0.50	12.7	0.16	4.1	0.32	8.1	Cat. 5e UTP/Cat. 6 UTP/ Cat. 6A UTP/Cat. 5e FTP/ 10 – 6 AWG	200		
S100X225VAC			2.25	57.2	0.75	19.1	0.24	6.1	0.48	12.2	Cat. 6 FTP/Cat. 6A UTP/ Cat. 6A FTP/8 – 4 AWG	125		
S100X400VAC			4.00	101.6	1.00	25.4	0.32	8.1	0.95	24.3	2 – 1 AWG	75		

P1™ Marker Plate Label Cassettes for PanTher™ LS8E/LS8EQ Hand-Held Thermal Transfer Printers



- Fast loading P1™ Label Cassette includes both label material and ribbon to make changing labels easy
- Marker plates are designed for use on larger diameter wire/cables and may be applied after all terminations are complete
- Meets requirements for MIL-STD-202G, Method 215K, Solutions A, C and D

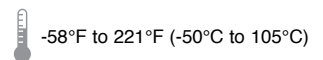

Part Number	Color	Width		Length		Print-On Area Width		Recommended Cable Tie		Labels Per Cassette	Std. Pkg. Qty.	Std. Ctn. Qty.
		In.	mm	In.	mm	In.	mm	Vertical	Horizontal			
M300X050Y6C	Yellow	3.00	76.2	0.50	12.7	1.80	45.7	PLT2.5I-C	PLT2.5I-C	50	1	10

Order number of cassettes required.

P1™ Flag Label Cassettes for PanTher™ LS8E/LS8EQ Hand-Held Thermal Transfer Printers



- Fast loading P1™ Label Cassette includes both label material and ribbon to make changing labels easy
- Provides larger labeling area for small cables
- Innovative design allows flag labels to be applied in either adhesive or non-adhesive orientations

-40°F to 302°F (-40°C to 150°C)

Part Number	Width		Length		Min. Cable O.D.		Max. Wire O.D.		Labels Per Cassette	Std. Pkg. Qty.	Std. Ctn. Qty.
	In.	mm	In.	mm	In.	mm	In.	mm			
F100X150AJC	1.00	25.4	1.50	38.1	0.12	3.1	0.20	5.1	200	1	10

Order number of cassettes required.

P1™ Military Grade Die Cut and Continuous Heat Shrink Label Cassettes for PanTher™ LS8E/LS8EQ Thermal Transfer Printers

- P1™ Label Cassette contains an integrated memory device for automatic formatting, recall of last legend used, and number of labels remaining in the cassette
- Fast loading label cassette includes both label material and ribbon to make changing labels easy
- Meets print performance requirements of MIL-STD-883F Method 2015.13, Solutions A, B and D, and MIL-STD-202G Method 215K, Solutions A, C and D
- Meets UL Standard 224 for flammability
- Shrink ratio 3:1
- Each cassette contains a roll of non-adhesive flattened polyolefin



-67°F to 275°F (-55°C to 135°C)

Military Grade Die-Cut Heat Shrink Label Cassettes

Part Number	Color	Diameter		Width		Length		Min Cable O.D.		Max Cable O.D.		Wire Range	Std. Pkg. Qty.	Std. Ctn. Qty.
		In.	mm	In.	mm	In.	mm	In.	mm	In.	mm			
H100X025H1C	White	0.13	3.1	0.25	6.4	1.00	25.4	0.04	1.0	0.13	3.3	22 – 18 AWG	1	10
H100X034H1C		0.19	4.7	0.34	8.6	1.00	25.4	0.06	1.5	0.19	4.8	18 – 12 AWG		
H100X044H1C		0.25	6.3	0.44	11.2	1.00	25.4	0.08	2.0	0.25	6.4	16 – 10 AWG		
H100X064H1C		0.38	9.7	0.64	16.3	1.00	25.4	0.13	3.3	0.38	9.7	12 – 6 AWG		

Military Grade Continuous Heat Shrink Tape Cassettes

Part Number	Color	Diameter		Width		Length		Min Cable O.D.		Max Cable O.D.		Wire Range	Std. Pkg. Qty.	Std. Ctn. Qty.
		In.	mm	In.	mm	Ft.	m	In.	mm	In.	mm			
H000X025H1C	White	0.13	3.1	0.25	6.4	8.0	2.4	0.04	1.0	0.13	3.3	22 – 18 AWG	1	10
H000X034H1C		0.19	4.7	0.34	8.6			0.06	1.5	0.19	4.8	18 – 12 AWG		
H000X034H2C	Yellow	0.19	4.7	0.34	8.6	6.0	1.8	0.08	2.0	0.25	6.4	16 – 10 AWG		
H000X044H1C	White	0.25	6.3	0.44	11.2			0.13	3.3	0.38	9.7	12 – 6 AWG		
H000X064H1C		0.38	9.7	0.64	16.3			0.17	4.3	0.50	12.7	8 – 1 AWG		
H000X084H1C		0.50	12.7	0.84	21.3									

TDP43ME Thermal Transfer Desktop Printer

- Compact, lightweight design enables use in office or remote locations
- 300 dpi thermal transfer printer creates crisp, clear legends with superior legibility
- Up to 4 inches per second print speed for fast label production
- Use to print a wide variety of self-laminating labels, component labels, non-laminated labels, heat shrink labels, marker plates and continuous tapes up to 4 inches wide
- Panduit® Easy-Mark Plus™ Labeling Software and hybrid ribbon included with printer
- UL 60950 listed, File # E165747



Part Number	Description	Std. Pkg. Qty.
BEST SELLER TDP43ME	300 dpi printer; includes printer, Panduit® Easy-Mark Plus™ Labeling Software, RMEH4BL black hybrid ribbon, AC power adapter with US power cord, USB cable, user manual, quick start card, and driver disk; for use in North America.	1
BEST SELLER TDP43ME-KIT	TDP43ME printer kit. Includes: printer, Panduit® Easy-Mark Plus™ Labeling Software, RMEH4BL black hybrid ribbon, AC power adapter with US power cord, USB cable, user manual, quick start card, TDP43ME-RS Roll Stand, TDP43ME-CASE, one roll of S100X150VATY labels, and driver disk; for use in North America.	

Accessories available.

Ribbons for Use with the TDP43ME Thermal Transfer Desktop Printer

- **Hybrid** – Recommended for use with self-laminating, heat shrink, component and non-laminated labels
- **Resin** – Recommended for use with polyester labels, continuous vinyl tape, marker plates and raised panel labels



Part Number	Description	Width		Length		Std. Pkg. Qty.
		In.	mm	Ft.	m	
BEST SELLER RMEH4BL *	Black hybrid thermal transfer ribbon. Use with heat shrink, self-laminating, Turn-Tell®, tan polyimide labels, and vinyl cloth labels.	4.25	108.0	300.0	91.4	1
RMER4BL* [^]	Black resin thermal transfer ribbon. Use with polyester labels, continuous vinyl tape, marker plates, and raised panel labels.					

Order number of ribbons required in multiples of Standard Package Quantity.

*For 2.5 inches wide ribbons, replace 4 in part number with 2. For example, the part number of a 2.5 inches wide black hybrid thermal transfer ribbon is RMEH2BL.

[^]Other colors available, change "BL" to: BU for Blue, RD for Red, or WH for White (Example: RMER4BU = Blue Resin Ribbon).

TDP43HE and TDP46HE Thermal Transfer Desktop Printers

- Convenient, easy setup; quickly begin producing labels
- Durable, clear communication through superior legibility
- Print small, fine characters and high-quality images and bar codes
- Allow continuous use in construction, industrial, and harsh environments
- Reduce time required to switch between label styles
- Fast label production without sacrificing print quality
- Panduit® Easy-Mark Plus™ Labeling Software included with printer
- Up to 8 inches per second print speed
- Connect quickly and easily to PC, and offers connectivity flexibility to print by USB, parallel, Ethernet, and serial
- UL 60950 listed, File # E165747



Part Number	Description	Std. Pkg. Qty.
TDP43HE	300 dpi printer; includes printer, Panduit® Easy-Mark Plus™ Labeling Software, RMEH4BL black hybrid ribbon, USB cable, user manual, quick start card, driver disk and US power cord; for use in North America.	1
TDP46HE	600 dpi printer; includes printer, Panduit® Easy-Mark Plus™ Labeling Software, RMEH4BL black hybrid ribbon, USB cable, user manual, quick start card, driver disk, and US power cord; for use in North America.	

www.panduit.com

TDP43HE and TDP46HE Thermal Transfer Desktop Printers



- **Hybrid** – Recommended for use with heat shrink, self-laminating, Turn-Tell® Labels, and vinyl cloth
- **Resin** – Recommended for use with polyester labels, continuous vinyl tapes, marker plates and raised panel labels

Part Number	Description	Width		Length		Std. Pkg. Qty.
		In.	mm	Ft.	m	
RHEH4BL	Black hybrid thermal transfer ribbon. Use with heat shrink, self-laminating, Turn-Tell® Labels, and vinyl cloth and tan polyimides labels.	4.33	110.0	1181.0	363.0	1
RHER4BL	Black resin thermal transfer ribbon. Use with polyester labels, continuous vinyl tape, marker plates, and raised panel labels.					

Order number of ribbons required in multiples of Standard Package Quantity.

Thermal Transfer Turn-Tell® Label **PATENTED**

- Innovative label design allows labels to rotate for visibility from any angle, and for repositioning on the wire/cable to align legends and improve aesthetics
- Labels can be easily installed on existing terminated wires and assemblies without disconnecting the wires/cables
- Use thermal transfer hybrid ribbon



TEMPERATURE
-40°F to 150°F (-40°C to 65.6°C)

BEST SELLER

Part Number	Print-On Area Color	Width		Length		Print-On Area Height		Min Cable O.D.		Max Cable O.D.		Wire Range	Labels Per Row	Labels Per Pkg.
		In.	mm	In.	mm	In.	mm	In.	mm	In.	mm			
R100X150V1T	White	1.00	25.4	1.50	38.1	0.50	12.7	0.22	5.6	0.28	7.1	Cat. 5e UTP/ Cat. 6 UTP/ Cat. 6A UTP	4	2500
R100X225V1T				2.25	57.2	0.75	19.1	0.28	7.1	0.39	9.9	Cat. 6 FTP/ Cat. 6 UTP/ Cat. 6A FTP		
R150X150V1T		1.50	38.1	1.5	38.1	0.5	12.7	0.22	5.6	0.28	7.1	Cat. 5e UTP/ Cat. 6 UTP/ Cat. 6A UTP/ Cat. 5e FTP		1000
R200X225V1T		2.0	50.8	2.25	57.2	0.75	19.1	0.22	5.6	0.28	7.1	Cat. 6 FTP/ Cat. 6A UTP/ Cat. 6A FTP		

Labels are roll mounted on 3.00 inches cores; when using the [TDP43ME](#) printer and 3.00 inches cores, the roll stand ([TDP43ME-RS](#)) is required.

Thermal Transfer Self-Laminating Labels



- Includes a colored print-on area and clear over-laminate to protect the legend for clear and durable identification
- Sized specifically for wire and cable applications
- Thin and conformable; preferred material for most general wire/cable labeling
- Use thermal transfer hybrid ribbon

 -40°F to 150°F (-40°C to 66°C)

Part Number	Print-On Area Color	Width		Length		Print-On Area Height		Min. Cable O.D.		Max Cable O.D.		Wire Range	Labels Per Row	Std. Pkg. Qty.									
		In.	mm	In.	mm	In.	mm	In.	mm	In.	mm												
S050X075VA1Y	White	0.5	12.7	0.75	19.1	0.25	6.4	0.08	2.0	0.16	4.1	Cat. 6 28 AWG/ 18 – 14 AWG	8	5000									
S050X075VATY*				2500																			
S050X125VA1Y				1.25	31.8	0.38	9.7	0.12	3.1	0.28	7.0	Cat. 3 UTP/ 12 - 10 AWG		5000									
S050X125VATY*				1.50	38.1	0.5	12.7	0.16	4.1	0.32	8.1	Cat. 5e UTP/ Cat. 6 UTP/ Cat. 6A UTP/ Cat. 5e FTP/ 10 – 6 AWG											
S050X150VA1Y																							
S050X150VATY*																							
S075X125VATY*				0.75	19.1	1.25	31.8	0.38	9.7	0.12	3.1				0.28	7.0	Cat. 3 UTP/12 - 10 AWG	5					
S075X150VATY*						1.50	38.1	0.5	12.7	0.16	4.1			0.32	8.1	Cat. 5e UTP/ Cat. 6 UTP/ Cat. 6A UTP/ Cat. 5e FTP/ 10 – 6 AWG							
S100X125VATY*				TIA Blue	1.00	25.4	1.25	31.8	0.38	9.7	0.12	3.1		0.28	7.0	Cat. 3 UTP/ 12 – 10 AWG	4	2500					
BEST SELLER S100X150VA1Y							1.50	38.1	0.50	12.7	0.16	4.1		0.32	8.1	Cat. 5e UTP/ Cat. 6 UTP/ Cat. 6A UTP/ Cat. 5e FTP/ 10 – 6 AWG							
BEST SELLER S100X150VATY*	5000																						
BEST SELLER S100X150VBTY*	1500																						
BEST SELLER S100X225VA1Y	2.25	57.2	0.75				19.1	0.24	6.1	0.48	12.1	Cat. 6 FTP/ Cat. 6A UTP/ Cat. 6A FTP/ 8 – 4 AWG											
BEST SELLER S100X225VATY*												5000											
S100X250VATY*	2.50	63.5	1.00				25.4	0.32	8.1	0.95	24.3	6 – 2 AWG	1000										
S100X400VA1Y	4.00	101.6	1.50				38.1	0.48	12.1	1.59	40.4	1/0 – 250 MCM	2 – 1 AWG	2500									
BEST SELLER S100X400VATY*													1000										
S100X650VATY*	White	6.50	165.1				1.50	38.1	0.48	12.1	1.59	40.4	1/0 – 250 MCM	1000									
S150X150VATY*				1.50	38.1	1.50								38.1	0.50	12.7	0.16	4.0	0.32	8.1	Cat. 5e UTP/ Cat. 6 UTP/ Cat. 6A UTP/ Cat. 5e FTP/ 10 – 6 AWG	2	5000
S150X225VATY*						2.25								57.2	0.75	19.1	0.24	6.1	0.48	12.1	Cat. 6 FTP/ Cat. 6A UTP/ Cat. 6A FTP/ 8 – 4 AWG		

Order number of labels required in multiples of Standard Package Quantity.

Thermal Transfer Self-Laminating Labels (continued)

 -40°F to 150°F (-40°C to 66°C)

Part Number	Print-On Area Color	Width		Length		Print-On Area Height		Min. Cable O.D.		Max Cable O.D.		Wire Range	Labels Per Row	Std. Pkg. Qty.
		In.	mm	In.	mm	In.	mm	In.	mm	In.	mm			
S150X400VATY*	White	1.50	38.1	4.00	101.6	1.00	25.4	0.32	8.1	0.95	24.1	2 – 1 AWG	2	2500
S200X150VATY*		2.00	50.8	1.50	38.1	0.50	12.7	0.16	4.0	0.32	8.1	Cat. 5e UTP/ Cat. 6 UTP/ Cat. 6A UTP/ Cat. 5e FTP/ 10 – 6 AWG		5000
S200X225VA1Y				2.25	57.2	0.75	19.1	0.24	6.1	0.48	12.4	Cat. 6 FTP/ Cat. 6A UTP/ Cat. 6A FTP/ 8 – 4 AWG		500
S200X225VATY*														1000
S200X250VATY*				2.50	63.5	1.00	25.4	0.32	8.1	0.95	24.3	6 – 2 AWG		500
S200X400VA1Y														1000
S200X400VATY*				4.00	101.6	1.50	38.1	0.48	12.1	1.59	40.4	1/0 – 250 MCM		250
S200X650VA1Y														1000
S200X650VATY*				6.50	165.1	1.50	38.1	0.48	12.1	1.59	40.4	1/0 – 250 MCM		1000

Order number of labels required in multiples of Standard Package Quantity.

*Labels are roll mounted on 3.00" cores; when using the [TDP43ME](#) printer and 3.00" cores, the roll stand ([TDP43ME-RS](#)) is required.

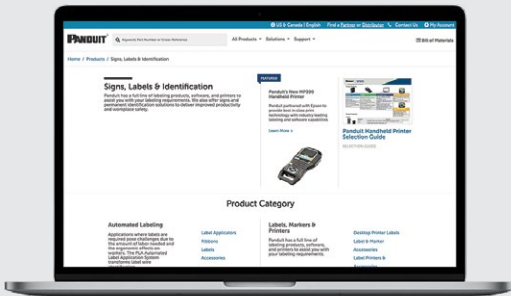

**Like what you see?
Want more?**

Visit www.panduit.com for the full offering of Panduit products

www.panduit.com

Thermal Transfer Military Grade Single-Sided Heat Shrink Labels

- Permanent, one-piece, heat shrink sleeve designed to provide clear, durable identification of wires and cables
- Meet UL Standard 224 with a VW-1 rating for flammability and AMS-DTL-23053/5C (Class 1 and Class 3)
- Meet SAE-AS81531, MIL-STD-883F Method 2015.13, Solutions A, B, and D, and MIL-STD-202G Method 215K, Solutions A, C, and D when printed with resin and hybrid thermal transfer ribbons
- Shrink ratio 3:1
- Tested for use as an identification marker in (Class 1E) harsh environments
- Use thermal transfer hybrid ribbon or white resin ribbon
- UL224 recognized, File # E205133; CSA certified, C22.2 No. 198.1.06, File # 256205



 -67°F to 275°F (-55°C to 135°C)

	Part Number (White)	Part Number (Yellow)	Diameter		Width		Height		Min Cable O.D.		Max Cable O.D.		Wire Range	Labels Per Row	Labels Per Roll	Std. Pkg. Qty. (Roll)
			In.	mm	In.	mm	In.	mm	In.	mm	In.	mm				
BEST SELLER	H100X025H1*	H100X025H2T	0.13	3.1	1.00	25.4	0.25	6.4	0.04	1.0	0.13	3.3	22 – 18 AWG	2	1000	1
	H200X025H1*	H200X025H2T			2.00	50.8								1	500	
BEST SELLER	H100X034H1*	H100X034H2T	0.19	4.7	1.00	25.4	0.34	8.6	0.06	1.5	0.19	4.8	18 – 12 AWG	2	1000	
BEST SELLER	H200X034H1*	H200X034H2T			2.00	50.8								1	500	
BEST SELLER	H100X044H1*	H100X044H2T	0.25	6.3	1.00	25.4	0.44	11.2	0.08	2.0	0.25	6.4	16 – 10 AWG	2	1000	
BEST SELLER	H200X044H1*	H200X044H2T			2.00	50.8								1	500	
BEST SELLER	H200X064H1*	H200X064H2T	0.38	9.7	2.00	50.8	0.64	16.3	0.13	3.3	0.38	9.7	12 – 6 AWG	1	500	

Order number of labels required in multiples of Standard Package Quantity.
 *Available in Bulk packages (5 times Labels Per Roll), add -B to end of part number

Thermal Transfer Continuous Tape

1B-TGB

- Tapes offer crisp, clear legends with superior legibility
- Conformable material for flat applications and safety and facility identification
- Can be over-laminated to increase durability
- Use thermal transfer resin ribbon
- Temperature range: -40°F to 302°F (-40°C to 150°C)

Part Number	Color	Material	Width		Length		Std. Pkg. Qty. (Roll)
			In.	mm	Ft.	m	
T400X000YP1	White	Super-Tack Polyester	4.00	101.6	100.0	30.5	1
T400X000Y81	Yellow						
T400X000YS1	Green						
T400X000YU1	Orange						

Order number of rolls required in multiples of Standard Package Quantity.

Laser/Ink Jet Self-Laminating Labels



- Labels can be printed in both laser and ink jet printers
- Self-laminating adhesive labels include a colored print-on area and clear overlaminates
- Provide durability; high-temperature resistance, and dimensional stability; do not stretch or easily tear; preferred method for wire/cable labeling
- Meets ASTM E-595 for air space handling (white only)

 -65°F to 225°F (-54°C to 107°C)

Part Number	Print-On Area Color	Width		Length		Print-On Area Height		Min Cable O.D.		Max Cable O.D.		Wire/Cable Size Range	Labels Per Row	Labels Per Sheet	Labels Per Pkg.
		In.	mm	In.	mm	In.	mm	In.	mm	In.	mm				
S050X075YAJ	White	0.5	12.7	0.75	19.0	0.25	6.4	0.08	2.0	0.16	4.1	18-14 AWG	7	42	2500
S050X125YAJ				1.25	31.8	0.38	9.6	0.12	3.0	0.28	7.1	12-10 AWG			
S050X150YAJ				1.5	38.1	0.5	12.7	0.16	4.1	0.32	8.1	10-6 AWG			
S075X125YAJ		0.75	19.0	1.25	31.8	0.38	9.6	0.12	3.0	0.28	7.1	12-10 AWG			
S075X150YAJ				1.5	38.1	0.5	12.7	0.16	4.1	0.32	8.1	10-6 AWG			
S100X075YAJ				0.75	19.0	0.25	6.4	0.08	2.0	0.16	4.1	18-14 AWG			
S100X125YAJ	1.00	25.4	1.25	31.8	0.38	9.7	0.12	3.1	0.28	7.0	Cat. 3 UTP/ 12-10 AWG	8	56	1000	
S100X150YAJ			TIA Blue	1.50	38.1	0.50	12.7	0.16	4.1	0.32	8.1				Cat. 5e UTP/ Cat. 6 UTP/ Cat. 6A UTP /Cat. 5e FTP/10 – 6 AWG
S100X150YBJ															Cat. 5e UTP/ Cat. 6 UTP/ Cat. 6A UTP /Cat. 5e FTP/10 – 6 AWG
S100X225YAJ			White	2.00	50.8	2.25	57.2	0.75	19.1	0.24	6.1				0.48
S100X400YAJ	4.00	101.6				1.00	25.4	0.32	8.1	0.95	24.3	2 – 1 AWG			
S100X650YAJ	6.50	165.1				1.50	38.1	0.48	12.1	1.59	40.4	1/0 – 350 MCM			
S200X150YAJ	1.50	38.1				0.50	12.7	0.16	4.1	0.32	8.1	Cat. 5e UTP/Cat. 6 UTP/ Cat. 6A UTP /Cat. 5e FTP/10 – 6 AWG			
S200X225YAJ	2.25	57.2				0.75	19.1	0.24	6.1	0.48	12.1	Cat. 6 FTP/Cat. 6A UTP/ Cat. 6A FTP/ 8 – 4 AWG			
S200X400YAJ	4.00	101.6				1.00	25.4	0.32	8.1	0.95	24.3	2 – 1 AWG			
S200X650YAJ	6.50	165.1	1.50	38.1	0.48	12.1	1.59	40.4	1/0 – 350 MCM						

Order number of labels required in multiples of Standard Package Quantity.

Stainless Steel

Stainless Steel Marker Plates provide permanent identification for pipes, conduits, valves, and cables in harsh environments. Raised slot, easy feed design - for use with Panduit® Pan-Steel® Stainless Steel Cable Ties for fast installation at the lowest installed cost.

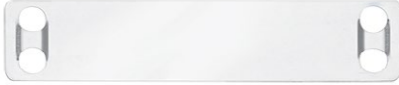

- Provides permanent identification of pipes, conduit, valves, cables and equipment in harsh environments
- Designed for use with Panduit® Pan-Steel® Stainless Steel Cable Ties for fast installation at lowest installed cost
- Designated plates feature easy feed design with a raised slot to simplify cable tie installation and improve productivity

 -112°F to 1000°F (-80°C to 538°C)

BEST SELLER

Part Number	Material	Length/ Diameter		Width/ Diameter		Thickness		Used with Pan-Steel Cable Ties**	For Use With			Std. Pkg. Qty. [^]	Std. Ctn. Qty.
		In.	mm	In.	mm	In.	mm		MIM	PES197	PES400		
MMP350-M316	316 Stainless Steel	3.50	89.0	0.75	19.0	0.010	0.25	MLT-S	✓	✓	✓	1000	4000
MMP350-M	304 Stainless Steel												
MMP350H-MAL	Aluminum												
MMP350W38-M316	316 Stainless Steel			0.38	9.7			MLT-S					

[^]Order number of pieces required, in multiples of Standard Package Quantity.

PES400 Embossing System



- Permanent identification solution on-site and on-demand
- Creates raised characters on stainless steel and aluminum marker plates for maximum visibility for medium to high volume applications exposed to dirt and paint
- Fast speed up to 300 plates per hour
- Includes 3 mm and 5 mm characters
- Includes Easy-Mark™ Plus Labeling Software

Part Number	Description	Std. Pkg. Qty.
PES400	Panduit embossing system, 0.188" (5mm) and 0.118" (3mm) characters, 35.8" x 23.6" x 16.5", 154lb. (75kg), 100 to 240 VAC, 50/60Hz	1

Characters include: ABCD...Z, 0123...9, @ # % & * () - + : , . / ' "

Tools and Tapes



Part Number	For Use With	Description	Lettering Height	
			In.	mm
Metal Embossing Hand Tool				
MEHT187	META-X, METS3-X, METS4-X	Includes (1) Tool, (1) additional marking wheel, (1) carrying case, (1) roll each META (aluminum) and METS (stainless steel) tape.	0.1875	4.76

Part Number	Color	Material	Overall Width		Overall Length		Overall Thickness	
			In.	mm	In.	mm	In.	mm
Indoor/Outdoor Embossing Tape								
METS3-X	Silver	316 Stainless Steel	0.5	12.7	252	6401	0.01	0.1
METS4-X		304 Stainless Steel						

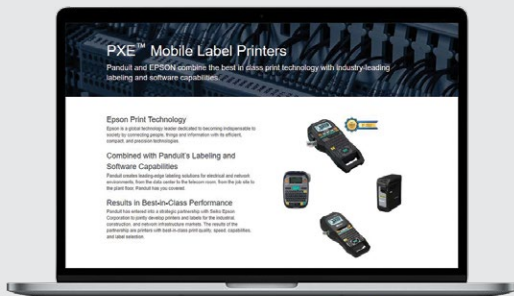

**Like what you see?
Want more?**

Visit panduit.com/mobileprinters for the full offering of Panduit products

www.panduit.com



Code Conductor, One-Hole, Standard Barrel with Window Lug

For Use with Stranded Copper Conductors

Type LCA

- The Copper Compression Connector Lugs, one-hole, standard barrel, has color-coded barrels marked with Panduit and specified competitor die index numbers for proper crimp die selection

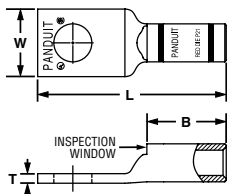

- An inspection window aids to visually assure full conductor insertion, and the tin-plated material helps to inhibit corrosion
- UL Listed and CSA certified to 35kV** and temperature rated to 90°C when crimped with Panduit and specified competitor crimping tools and dies
- Tested by Telcordia – meets NEBS Level 3
- American Bureau of Shipping Approved

Part Number	Copper Conductor Size	Stud Hole Size (In.)	Figure Dimensions (In.)				Panduit Color Code	Panduit Die Index No.‡	Burndy Die Index No.‡	T&B Die Index No.‡	Wire Strip Length (In.)	Std. Pkg. Qty.
			W	B	T	L						
LCA10-10-L*	#14 – #10 AWG STR	#10	0.38	0.38	0.06	1.07	—	—	—	—	0.4375	50
LCA8-10-L	#8 AWG		0.41	0.56	0.08	1.25	Red	P21	49	21	0.625	
BEST SELLER LCA8-14-L		0.25	0.48		0.07	1.34						
LCA8-38-L	0.375	0.60	0.05	1.56								
LCA6-10-L	#6 AWG	0.81	0.45	0.09	1.52	Blue	P24	7	24	0.875		
BEST SELLER LCA6-14-L			0.25	0.48	0.08						1.61	
LCA6-56-L			0.3125	0.56	0.07						1.73	
BEST SELLER LCA6-38-L			0.375	0.62	0.06						1.83	
BEST SELLER LCA4-14-L	#4 – #3 AWG STR, #2 AWG SOL	0.25	0.55	0.09	1.63	Gray	P29	8	29	0.9375		
LCA4-56-L		0.3125		1.75								
BEST SELLER LCA4-38-L		0.375		0.62	0.07						1.85	
BEST SELLER LCA2-14-Q	#2 AWG	0.88	0.25	0.10	1.77	Brown	P33	10	33	0.9375		
LCA2-56-Q			0.3125		1.90							
BEST SELLER LCA2-38-Q			0.375		1.97							
LCA2-12-Q			0.5		0.75						0.08	2.21
BEST SELLER LCA1-14-E	#1 AWG	0.25	0.70	0.11	1.79	Green	P37	11	37	20		
LCA1-38-E		0.375		1.99								
LCA1/0-14-X	1/0 AWG	0.25	0.76	0.94	1.95	Pink	P42	12	42	1		
LCA1/0-56-X		0.3125			2.00							
BEST SELLER LCA1/0-38-X		0.375			2.08							
BEST SELLER LCA2/0-56-X	2/0 AWG	0.3125	0.85	0.98	2.09	Black	P45	13	45	1.0625		
LCA2/0-38-X		0.375			2.15							
LCA2/0-12-X		0.5			2.40							
LCA3/0-56-X		0.3125			2.28							
BEST SELLER LCA3/0-38-X	3/0 AWG	0.375	0.96	1.14	2.34	Orange	P50	14	50	1.1875		
LCA3/0-12-X		0.5			2.59							
BEST SELLER LCA4/0-38-X	4/0 AWG	0.375	1.06	1.19	2.45	Purple	P54	15	54	1.25		
BEST SELLER LCA4/0-12-X		0.5			2.68							
LCA250-38-X	250 kcmil	0.375	1.17	1.25	2.55	Yellow	P62	16	62	1.3125		
LCA250-12-X		0.5			2.78							
LCA350-38-X	350 kcmil	0.375	1.28	1.44	2.98	Red	P71	18	71	1.5		
LCA350-12-X		0.5			3.09							

‡Visit www.panduit.com for tool and die information.

*Not tested to NEBS Level 3 requirements.

**Consult cable manufacturer for voltage stress relief instructions with applications greater than 2000V.

(continued on next page)



Code Conductor, One-Hole, Standard Barrel with Window Lug (continued)

Part Number	Copper Conductor Size	Stud Hole Size (In.)	Figure Dimensions (In.)				Panduit Color Code	Panduit Die Index No.‡	Burndy Die Index No.‡	T&B Die Index No.‡	Wire Strip Length (In.)	Std. Pkg. Qty.
			W	B	T	L						
LCA400-12-6	400 kcmil	0.5	1.39	1.50	0.18	3.22	Blue	P76	19	76	1.5625	6
LCA500-12-6	500 kcmil		1.54	1.75	0.22	3.55	Brown	P87	20	87	1.8125	
LCA600-12-6	600 kcmil		1.70		0.26	4.20	Green	P94	22	94		

‡Visit www.panduit.com for tool and die information.

*Not tested to NEBS Level 3 requirements.

**Consult cable manufacturer for voltage stress relief instructions with applications greater than 2000V.



Code Conductor, One-Hole, Long Barrel Lug

For Use with Stranded Copper Conductors

Type LCB

- Long barrel maximizes number of crimps and provides premium wire pull-out strength and electrical performance
- Color-coded barrels marked with Panduit and specified competitor die index numbers for proper crimp die selection
- Enclosed barrel prevents corrosive material from entering barrel when used in harsh environments
- Tin-plated to inhibit corrosion
- UL Listed and CSA Certified to 35 kV** and temperature rated to 90°C when crimped with Panduit and specified competitor crimping tools and dies
- UL Listed and CSA Certified for wide wire range-taking capability when crimped with Panduit® Uni-Die™ Dieless Crimping Tools‡
- Tested by Telcordia – meets NEBS Level 3
- American Bureau of Shipping Approved

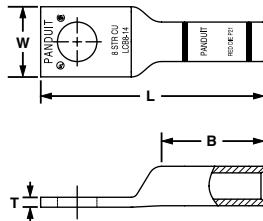

Part Number	Copper Conductor Size	Stud Hole Size (In.)	Figure Dimensions (In.)				Panduit Color Code	Panduit Die Index No.‡	Burndy Die Index No.‡	T&B Die Index No.‡	Wire Strip Length (In.)	Std. Pkg. Qty.
			W	B	T	L						
LCB6-14-L	#6 AWG	0.25	0.48	1.07	0.08	1.93	Blue	P24	7	24	1.125	50
LCB2-14-Q	#2 AWG		0.60	1.16	0.10	2.14	Brown	P33	10	33	1.25	25
LCB2-56-Q		0.3125	0.66			2.27						
LCB2/0-38-X	2/0 AWG	0.375	0.85	1.50	0.13	2.82	Black	P45	13	45	1.5625	10
LCB4/0-12-X	4/0 AWG	0.5	1.06	1.56	0.14	3.22	Purple	P54	15	54	1.625	

‡Visit www.panduit.com for tool and die information.

**Consult cable manufacturer for voltage stress relief instructions with applications greater than 2000V.



Code Conductor, Two-Hole, Standard Barrel with Window Lug

For Use with Stranded Copper Conductors

Type LCD

- The Copper Compression Connector Lugs, two-hole, standard barrel, has color-coded barrels marked with Panduit and specified competitor die index numbers for proper crimp die selection
- The long barrel maximizes the number of crimps and provides premium wire pull-out strength and performance

- An inspection window aids to visually assure full conductor insertion, and the tin-plated material helps to inhibit corrosion
- UL Listed and CSA certified to 35kV** and temperature rated to 90°C when crimped with Panduit and specified competitor crimping tools and dies
- Tested by Telcordia – meets NEBS Level 3
- American Bureau of Shipping approved
- Available with NEMA hole sizes and spacing

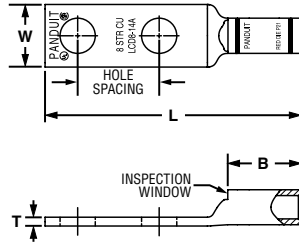

Part Number	Copper Conductor Size	Stud Hole Size (In.)	Stud Hole Spacing (In.)	Figure Dimensions (In.)				Panduit Color Code	Panduit Die Index No.‡	Burndy Die Index No.‡	T&B Die Index No.‡	Wire Strip Length (In.)	Std. Pkg. Qty.
				W	B	T	L						
BEST SELLER LCD10-10A-L*	#14 – #10 AWG STR, #12 – #10 AWG SOL	#10	0.63	0.38	0.38	0.06	1.69	—	—	—	—	0.4375	50
LCD10-14A-L*				0.42		0.05	1.78						
LCD10-14B-L*				0.75		0.05	1.91						
LCD8-10A-L	#8 AWG	#10	0.63	0.41	0.56	0.08	1.88	Red	P21	49	21	0.625	50
LCD8-14A-L				0.48		0.07	1.97						
LCD6-10A-L	#6 AWG	#10	0.63	0.46	0.81	0.08	2.15	Blue	P24	7	24	0.875	50
BEST SELLER LCD6-14A-L				0.48			2.24						
LCD6-14D-L				1.00			2.61						
LCD4-14A-L	#4 – #3 AWG STR, #2 AWG SOL	0.25	0.63	0.55	0.81	0.09	2.26	Gray	P29	8	29	0.9375	25
LCD2-14A-Q	#2 AWG			0.60			0.88						
LCD2/0-14A-X	2/0 AWG	0.75	0.75	0.85	0.98	0.13	2.70	Black	P45	13	45	1.0625	10
LCD2/0-14B-X				0.85			2.83						

‡Visit www.panduit.com for tool and die information.

*Not tested to NEBS Level 3 requirements.

**Consult cable manufacturer for voltage stress relief instructions with applications greater than 2000V.

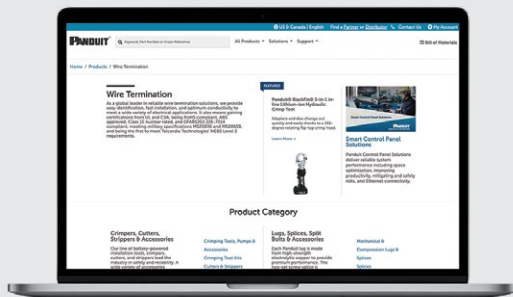

Like what you see? Want more?

Visit www.panduit.com for the full offering of Panduit products

www.panduit.com



Code Conductor, Two-Hole, Long Barrel Lug

For Use with Stranded Copper Conductors

Type LCC

- The Copper Compression Connector Lugs, two-hole, long barrel, has color-coded barrels marked with Panduit and specified competitor die index numbers for proper crimp die selection
- The long barrel maximizes the number of crimps and provides premium wire pull-out strength and performance
- The enclosed barrel prevents corrosive material from entering the barrel when used in harsh environments
- Tin-plated to inhibit corrosion
- UL Listed and CSA certified to 35kV** and temperature rated to 90°C when crimped with Panduit and specified competitor crimping tools and dies
- Tested by Telcordia – meets NEBS Level 3
- American Bureau of Shipping approved

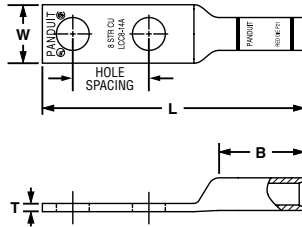

Part Number	Copper Conductor Size	Stud Hole Size (In.)	Stud Hole Spacing (In.)	Figure Dimensions (In.)				Panduit Color Code	Panduit Die Index No.‡	Burdny Die Index No.‡	T&B Die Index No.‡	Wire Strip Length (In.)	Std. Pkg. Qty.	
				W	B	T	L							
LCC6-14A-L	#6 AWG	0.25	0.63	0.48	1.07	0.08	2.56	Blue	P24	7	24	1.125	50	
LCC6-38D-L				0.62										0.06
LCC4-14A-L	#4 – #3 AWG STR, #2 AWG SOL	0.25	0.63	0.55	1.05	0.09	2.58	Gray	P29	8	29	1.125	50	
LCC4-38D-L				0.62										0.08
LCC2-14A-Q	#2 AWG	0.25	0.63	0.60	1.16	0.10	2.77	Brown	P33	10	33	1.25	25	
LCC2-14B-Q				0.75			0.60							2.89
LCC4/0-12-X ♦	4/0 AWG	0.5	1.75	1.75	1.06	1.56	0.14	5.13	Purple	P54	15	54	1.625	10
LCC250-12-X ♦	250 kcmil			1.00	1.17	1.60		4.32	Yellow	P62	16	62	1.6875	
LCC350-12-X ♦	350 kcmil			1.28	2.24	0.17	5.99	Red	P71	18	71	2.3125	6	
LCC400-12-6 ♦	400 kcmil			1.39	2.30	0.18	6.10	Blue	P76	19	76	2.375		
LCC500-12-6 ♦	500 kcmil			1.54	2.50	0.22	6.36	Brown	P87	20	87	2.5625		
LCC600-12-6 ♦	600 kcmil			1.70	2.69	0.26	6.63	Green	P94	22	94	2.75		
LCC750-12-6 ♦	750 kcmil			1.89	2.87	0.26	7.04	Black	P106	24	106	2.9375	3	
LCC1000-12-3 ♦	1000 kcmil			2.17	3.00	0.32	7.29	White	P125	27	125	3.0625		

‡Visit www.panduit.com for tool and die information.

**Consult cable manufacturer for voltage stress relief instructions with applications greater than 2000V.

♦NEMA hole sizes and spacing.

BEST SELLER

BEST SELLER



Code Conductor, Two-Hole, Long Barrel with Window Lug

For Use with Stranded Copper Conductors

Type LCC-W

- The Copper Compression Connector Lugs, two-hole, long barrel, has color-coded barrels marked with Panduit and specified competitor die index numbers for proper crimp die selection
- The long barrel maximizes the number of crimps and provides premium wire pull-out strength and performance
- An inspection window aids to visually assure full conductor insertion, and the tin-plated material helps to inhibit corrosion
- UL Listed and CSA certified to 35kV** and temperature rated to 90°C when crimped with Panduit and specified competitor crimping tools and dies
- Tested by Telcordia – meets NEBS Level 3

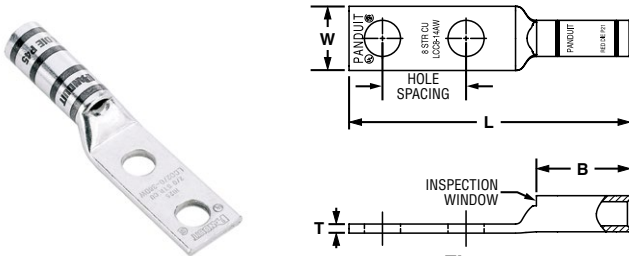

Figure 1

Part Number	Fig. No.	Copper Conductor Size	Stud Hole Size (In.)	Stud Hole Spacing (In.)	Figure Dimensions (In.)				Panduit Color Code	Panduit Die Index No.‡	Burndy Die Index No.‡	T&B Die Index No.‡	Wire Strip Length (In.)	Std. Pkg. Qty.
					W	B	T	L						
LCC10-14AW-L*	1	#14 – 10 AWG STR, #12 – 10 AWG SOL	0.25	0.63	0.42	0.53	0.05	1.93	—	—	—	—	0.5625	50
LCC8-10AW-L		#8 AWG	#10		0.41	0.70	0.08	2.01	Red	P21	49	21	0.75	
LCC6-14AW-L		#6 AWG	0.25		0.48	1.07	0.08	2.49	Blue	P24	7	24	1.125	
LCC6-14JAW-L	2	#6 AWG	0.25	0.50–0.63	0.48	1.07	0.08	2.49	Blue	P24	7	24	1.125	
LCC4/0-12W-X ♦	1	4/0 AWG	0.5	1.75	1.06	1.56	0.14	4.95	Purple	P54	15	54	1.625	10
LCC250-12W-X ♦		250 kcmil			1.17	1.61	0.14	5.03	Yellow	P62	16	62	1.6875	
LCC350-12W-X ♦		350 kcmil			1.28	2.24	0.17	5.76	Red	P71	18	71	2.3125	
LCC400-12W-6 ♦		400 kcmil			1.28	2.30	0.17	5.84	Blue	P76	19	76	2.375	6
LCC500-12W-6 ♦		500 kcmil			1.54	2.50	0.22	6.12	Brown	P87	20	87	2.5625	
LCC600-12W-6 ♦		600 kcmil			1.70	2.69	0.26	6.36	Green	P94	22	94	2.75	

BEST SELLER

‡Visit www.panduit.com for tool and die information.

*Not tested to NEBS level 3 requirements.

**Consult cable manufacturer for voltage stress relief instructions with applications greater than 2000V.

♦NEMA hole sizes and spacing.

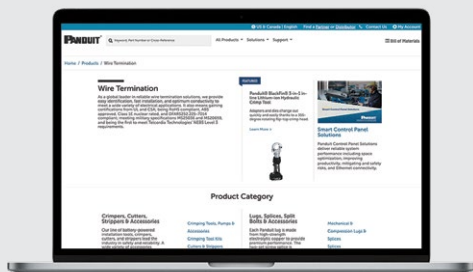

Like what you see? Want more?

Visit www.panduit.com for the full offering of Panduit products

www.panduit.com



Code Conductor, Standard Barrel, Butt Splice

For Use with Stranded Copper Conductors

Type SCS

- Color-coded barrels marked with Panduit and specified competitor die index numbers for proper crimp die selection
- Internal wire stops to prevent over-insertion of conductor
- Tin-plated to inhibit corrosion
- UL Listed and CSA Certified to 35 kV** and temperature rated to 90°C when crimped with Panduit and specified competitor crimping tools and dies
- UL Listed and CSA Certified for wide wire range-taking capability when crimped with Panduit® Uni-Die™ Dieless Crimping Tools‡
- Tested by Telcordia – meets NEBS Level 3
- American Bureau of Shipping approved

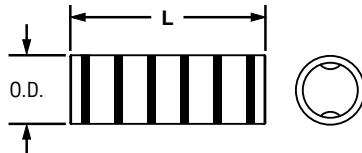

Part Number	Copper Conductor Size	Figure Dimensions (In.)		Panduit Color Code	Panduit Die Index No.‡	Burndy Die Index No.‡	T&B Die Index No.‡	Wire Strip Length (In.)	Std. Pkg. Qty.
		Barrel O.D.	L						
SCS6-L	#8 AWG	0.27	1.50	Red	P21	49	21	1.0625	50
SCS2-Q	#2 AWG	0.42	1.87	Brown	P33	10	33	0.875	25
SCS3/0-X	3/0 AWG	0.64	2.12	Orange	P50	14	50	1	10

‡Visit www.panduit.com for tool and die information.

**Consult cable manufacturer for voltage stress relief instructions with applications greater than 2000V.



Code Conductor, Long Barrel, Butt Splice

For Use with Stranded Copper Conductors

Type SCL

- Long barrel maximizes the number of crimps and provides premium wire pull-out strength and electrical performance
- Color-coded barrels marked with Panduit and specified competitor die index numbers for proper crimp die selection
- Internal wire stops to prevent over-insertion of conductor
- Tin-plated to inhibit corrosion
- UL Listed and CSA Certified to 35 kV** and temperature rated to 90°C when crimped with Panduit and specified competitor crimping tools and dies
- UL Listed and CSA Certified for wide wire range-taking capability when crimped with Panduit® Uni-Die™ Dieless Crimping Tools‡
- Tested by Telcordia – meets NEBS Level 3

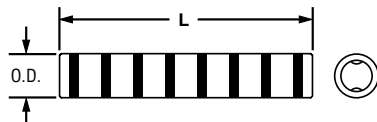

Part Number	Copper Conductor Size	Figure Dimensions (In.)		Panduit Color Code	Panduit Die Index No.‡	Burndy Die Index No.‡	T&B Die Index No.‡	Wire Strip Length (In.)	Std. Pkg. Qty.
		Barrel O.D.	L						
SCL6-L	#6 AWG	0.31	2.38	Blue	P24	7	24	1.125	50

‡Visit www.panduit.com for tool and die information.

**Consult cable manufacturer for voltage stress relief instructions with applications greater than 2000V.



Battery Cable Copper Compression Lugs

For Use with Class K Flexible Stranded Copper Conductor

- Standard barrel without inspection window to prevent contaminants from entering barrel
- Flared barrel entry for ease of inserting flex conductors
- High conductivity copper lugs, tin plated to meet ASTM Class C specification for corrosion resistance
- High pullout strength for heavy duty applications
- Embossed wire size identification on the lug
- Military Pullout Strength requirements when using Panduit recommended tooling



Part Number	Copper Conductor Size	Stud Hole Size (In.)	W	B	T	L	Die Part Number	Panduit Die Color	Wire Strip Length (In.)	Std. Pkg. Qty.
A6-14RH-C	6	0.25	0.54	0.50	0.07	1.33	KC22-6	Blue	0.5625	100
A2-14RH-C	2		0.60	0.74	0.10	1.71	KC22-2	Brown	0.75	
A2-38RH-C		0.375	1.80							
A2-38RF-C			1.26							
A2-56RH-C		0.3125	1.78							
A2-56RF-C			1.26							
A1/0-38RH-C		1/0	0.375			0.76				
A1/0-38RF-C	1.40									
A2/0-38RH-C	2/0	0.3125	0.85	0.88	1.99	CD22-2/0	Black	0.9375		
A2/0-56RH-C					1.89					
A2/0-12RF-C					0.5				1.58	
A4/0-38RF-C	4/0	0.375	1.02	0.91	1.65	KC22-4/0	Purple	0.9375		
A4/0-38RH-C		0.3125			1.65					
A4/0-56RF-C					1.65					
A4/0-12RF-C		0.5			2.39					



Flex Conductor, One-Hole, Standard Barrel with Window Lug

For Use with Flexible, Extra-Flexible, and Code Stranded Copper Conductors

Type LCAX

- The Copper Compression Connector Lugs, one-hole, standard barrels, has color-coded barrels marked with Panduit and specified competitor die index numbers for proper crimp die selection

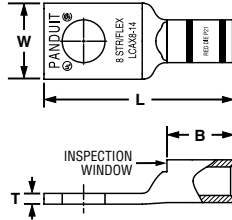

- The generously beveled wire entry prevents bent back strands when inserting the conductor into the barrel
- An inspection window to visually assure full conductor insertion
- Tin-plated to inhibit corrosion
- UL Listed and CSA certified to 35kV** and temperature rated to 90°C when crimped with Panduit and specified competitor crimping tools and dies
- American Bureau of Shipping approved

Part Number	Flex Conductor Size		Code Conductor Size	Stud Hole Size (In.)	Figure Dimensions (In.)				Panduit Color Code	Panduit Die Index No.‡	Burndy Die Index No.‡	T&B Die Index No.‡	Wire Strip Length (In.)	Std. Pkg. Qty.
	Class G, H, I, K, M	Diesel Locomotive			W	B	T	L						
LCAX6-14-L	#6 AWG	#6 AWG	#6 AWG	0.25	0.48	0.48	0.08	1.28	Blue	P24	7	24	0.5625	50
LCAX4-14-L	#4 AWG	#5, #4, #3 AWG	#4 AWG		0.55	0.53	0.09	1.35	Gray	P29	8	29	0.625	
LCAX2-14-E*	#2 AWG	#2 AWG	#2 AWG	0.3125	0.70	0.59	0.11	1.50	Brown	P33	10	33	1.0625	20
LCAX2-56-E*				1.63										
LCAX2-38-E*				1.70										
LCAX1-56-X	#1 AWG	#1 AWG	#1 AWG	0.3125	0.76	0.66	0.12	1.72	Green	P37	11	37	0.75	10
LCAX1/0-14-X	1/0 AWG	1/0 AWG	1/0 AWG	0.25	0.85	0.72	0.13	1.82	Pink	P42	12	42	0.75	
LCAX1/0-56-X				0.3125				2.14						
BEST SELLER LCAX1/0-38-X				0.375				1.97						
LCAX1/0-12-X				0.5				2.03						
LCAX2/0-56-X	2/0 AWG	2/0 AWG	2/0 AWG	0.3125	0.96	0.83	0.14	1.97	Black	P45	13	45	0.875	
BEST SELLER LCAX2/0-38-X				0.375				2.28						
LCAX2/0-12-X				0.5				2.17						
BEST SELLER LCAX3/0-38-X	3/0 AWG	3/0 AWG	3/0 AWG	0.375	1.06	0.91	0.14	2.17	Orange	P50	14	50	1	
LCAX3/0-12-X				0.5				2.40						
LCAX4/0-14-X	4/0 AWG	4/0 AWG	4/0 AWG	0.25	1.19	1.03	0.16	2.30	Purple	P54	15	54	1.0625	
LCAX4/0-56-X				0.3125				2.53						
BEST SELLER LCAX4/0-38-X				0.375				2.53						
BEST SELLER LCAX4/0-12-X				0.5				2.64						
LCAX250-38-X	250 kcmil	262.6 kcmil	—	0.375	1.28	0.17	0.17	2.57	Yellow	P62	16	62	1.0625	
LCAX250-12-X				0.5				2.68						
LCAX300-38-6	300 kcmil	313.1 kcmil	—	0.375	1.39	1.19	0.18	2.91	Red	P71	18	71H	1.25	
LCAX350-38-6	350 kcmil	373.7 kcmil	—					2.93						
LCAX350-12-6				450 kcmil	444.4 kcmil	—	0.5	1.70	1.40	0.26	3.09	Blue	P76	19
LCAX450-12-6	3.60													
LCAX500-12-6	3.64													
LCAX750-12-3	—	777.7 kcmil	—	0.5	2.17	1.66	0.32	3.94	Yellow	P115	L115	115H	1.75	3

‡Visit www.panduit.com for tool and die information.

*Not UL Listed or CSA Certified with Class K flex conductor when crimped with Burndy tools.

**Consult cable manufacturer for voltage stress relief instructions with applications greater than 2000V.



Flex Conductor, Two-Hole, Standard Barrel with Window Lug

For Use with Flexible, Extra-Flexible, and Code Stranded Copper Conductors

Type LCDX

- Can be used with code conductor and flex conductor class: G, H, I, K, M and Diesel Locomotive
- Generously beveled wire entry prevents bent back strands when inserting conductor into barrel
- Color-coded barrels marked with Panduit and specified competitor die index numbers for proper crimp die selection
- Inspection window to visually assure full conductor insertion
- Tin-plated to inhibit corrosion
- UL Listed and CSA Certified to 35 KV** and temperature rated to 90°C when crimped with Panduit and specified competitor crimping tools and dies
- American Bureau of Shipping approved
- Available with NEMA hole sizes and spacing

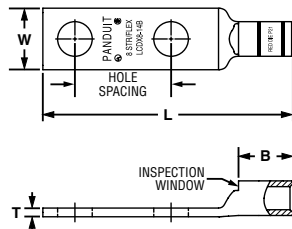

Part Number	Flex Conductor Size			Code Conductor Size	Stud Hole Size (In.)	Stud Hole Spacing (In.)	Figure Dimensions (In.)				Panduit Color Code	Panduit Die Index No.‡	Burndy Die Index No.‡	T&B Die Index No.‡	Wire Strip Length (In.)	Std Pkg Qty
	Class G, H, I, K, M	Diesel Locomotive					W	B	T	L						
LCDX8-14A-L	#8 AWG	#8 AWG	#8 AWG	0.25	0.63	0.48	0.42	0.07	1.83	Blue	P24	7	24	1.125	50	
LCDX6-14A-L	#6 AWG	#6 AWG	#6 AWG				0.48	0.08	1.91					0.5625		
LCDX2-14A-E*	#2 AWG	#2 AWG	#2 AWG			0.70	0.11	2.13	Brown	P33	10	33	0.6875	20		
LCDX4/0-14A-X	4/0 AWG	4/0 AWG	4/0 AWG			1.19	0.16	2.74	Purple	P54	15	54	1.0625	10		
LCDX4/0-38D-X	4/0 AWG	4/0 AWG	4/0 AWG	0.375	1.00	3.34										
LCDX350-12-6 ♦	350 kcmil	373.7 kcmil	—	0.5	1.75	1.54	1.29	0.22	4.92	Blue	P76	19	76H	1.375	6	

‡Visit www.panduit.com for tool and die information.

*Not UL Listed or CSA Certified with Class K flex conductor when crimped with Burndy tools.

**Consult cable manufacturer for voltage stress relief instructions with applications greater than 2000V.

♦ NEMA hole sizes and spacing.

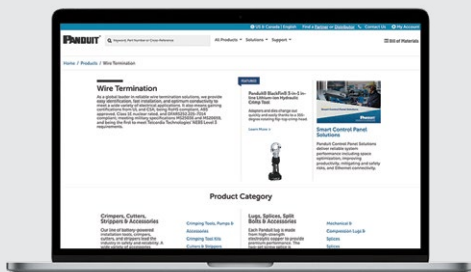

Like what you see? Want more?

Visit www.panduit.com for the full offering of Panduit products

www.panduit.com



Flex Conductor, Two-Hole, Long Barrel with Window Lug

For Use with Flexible, Extra-Flexible, and Code Stranded Copper Conductors

Type LCCX

- The Copper Compression Connector Lugs, two-hole, long barrel, has color-coded barrels marked with Panduit and specified competitor die index numbers for proper crimp die selection
- The long barrel maximizes the number of crimps and provides premium wire pull-out strength and performance
- The generously beveled wire entry prevents bent back strands when inserting the conductor into the barrel
- Tin-plated to inhibit corrosion
- UL Listed and CSA certified to 35kV** and temperature rated to 90°C when crimped with Panduit and specified competitor crimping tools and dies
- Available with NEMA hole sizes and spacing
- An inspection window to visually assure full conductor insertion

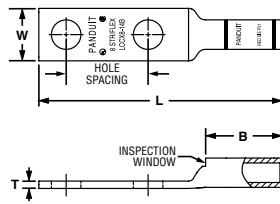

Figure 1

Part Number	Flex Conductor Size		Code Conductor Size	Stud Hole Size (In.)	Stud Hole Spacing (In.)	Figure Dimensions (In.)				Panduit Color Code	Panduit Die Index No.‡	Burndy Die Index No.‡	T&B Die Index No.‡	Wire Strip Length (In.)	Std. Pkg. Qty.
	Class G, H, I, K, M	Diesel Locomotive				W	B	T	L						
LCCX8-14A-L	#8 AWG	#8 AWG	#8 AWG	0.25	0.63	0.48	0.70	0.07	2.10	Red	P21	49	21	0.75	50
BEST SELLER LCCX6-14A-L	#6 AWG	#6 AWG	#6 AWG			0.48	1.07	0.08	2.49	Blue	P24	7	24		
LCCX4-14A-L	#4 AWG	#5, #4, #3 AWG	#4 AWG			0.55	1.05	0.09	2.49	Gray	P29	8	29		
LCCX2-14A-E*	#2 AWG	#2 AWG	#2 AWG	0.375	1.00	0.70	1.36	0.11	2.89	Brown	P33	10	33	1.4375	20
LCCX2-38D-E*	AWG	AWG	AWG			3.46									
LCCX2/0-14A-X	2/0 AWG	2/0 AWG	2/0 AWG	0.25	0.63	0.96	1.50	0.13	3.27	Black	P45	13	45	1.5625	10
LCCX2/0-38D-X	AWG	AWG	AWG						3.70						
LCCX4/0-38D-X	4/0 AWG	4/0 AWG	4/0 AWG	0.375	1.00	1.19	2.24	0.16	4.55	Purple	P54	15	54	2.3125	10
LCCX4/0-12-X ♦	AWG	AWG	AWG						5.73						
LCCX250-12-X ♦	250 kcmil	262.6 kcmil	—	0.5	1.75	1.28	2.24	0.17	5.77	Yellow	P62	16	62	2.375	6
LCCX300-12-6	300 kcmil	313.1 kcmil	—						5.85	Red	P71	18	71H		
LCCX350-12-6 ♦	350 kcmil	373.7 kcmil	—	0.5	1.75	1.54	2.50	0.22	6.13	Blue	P76	19	76H	2.5625	6
LCCX450-12-6 ♦	450 kcmil	444.4 kcmil	—						6.37	Brown	P87	20	87	2.75	
LCCX500-12-6 ♦	500 kcmil	535.3 kcmil	—						6.66	Pink	P99	L99	99H	2.9375	
LCCX650-12-6 ♦	—	646.4 kcmil	—						6.75	Black	P106	24	106H	3.00	

‡Visit www.panduit.com for tool and die information.

*Not UL Listed or CSA Certified with Class K flex conductor when crimped with Burndy tools.

**Consult cable manufacturer for voltage stress relief instructions with applications greater than 2000V.

♦NEMA hole sizes and spacing.



Code Conductor, Two-Hole, Aluminum Lug

For Use with Stranded Aluminum or Copper Code Conductors

Type LAB

- Manufactured from high conductivity thick wall wrought aluminum
- Factory pre-filled with joint compound and sealed with easy pull-out end plug to inhibit corrosion
- Color-coded barrel markings and Panduit and specified competitor die index numbers marked on barrel for proper crimp die selection
- Enclosed barrel prevents corrosive material from entering barrel when used in harsh environments
- Tin-plated to inhibit corrosion
- cULus listed to 35 kV** and temperature rated to 90°C when crimped with Panduit and specified competitor crimping tools and dies
- Available with NEMA hole sizes and spacing

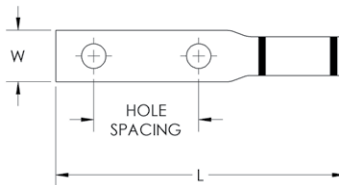

Part Number	Aluminum or Copper Conductor Size	Stud Hole Size (In.)	Stud Hole Spacing (In.)	Figure Dimensions (In.)				Panduit Color Code	Panduit Die Index No.‡	Burndy Die Index No.‡	T&B Die Index No.‡	Wire Strip Length (In.)	Std. Pkg. Qty.
				W	B	T	L						
LAB500-12-2R ♦	500 kcmil	0.5	1.75	1.62	3	0.46	6.8	Pink	P99	300	99	3.0625	2
LAB600-12-2 ♦	600 kcmil			1.73		0.5	7.56	Black	P106	473	106		
LAB750-12-20R ♦	750 kcmil			1.69	3.44	0.57	7.31	Red	P125	301	125		

‡Visit www.panduit.com for tool and die information.

**Consult cable manufacturer for voltage stress relief instructions with applications greater than 2000V.

♦NEMA hole sizes and spacing.

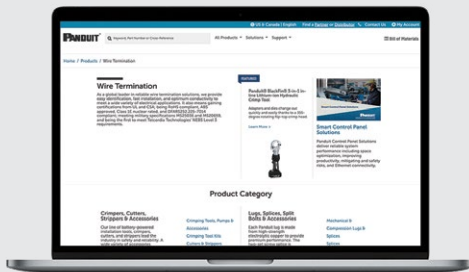

Like what you see? Want more?

Visit www.panduit.com for the full offering of Panduit products

www.panduit.com





Split Bolt, Copper

For Use with Copper Code Conductors

Type SBC

- Made from high strength copper alloy to resist corrosion and provide premium electrical and mechanical performance
- Offered with extra long body to allow connection of one or two taps to a single run conductor

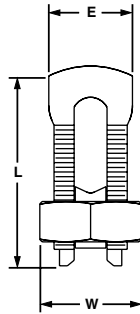

- Wide wire range-taking capability minimizes inventory requirements
- Nut hex provides correct fit with socket, box, or open end wrenches resulting in proper torquing of electrical connection
- Pressure bar provides secure connection on a full range of conductor combinations used with each connector assuring premium wire pull-out strength
- UL Listed and CSA Certified for use up to 600V and temperature rated 90°C
- UL Listed and CSA Certified for Direct Burial Grounding for connectors marked below

Part Number	Copper Conductor			Figure Dimensions (In.)			Std. Pkg. Qty.
	Range of Equal Run and Tap		Min Tap with One Max Run	E	W	L	
	Min	Max					
SBC8-C	#10 SOL	#8 STR	#16 STR	0.39	0.55	0.86	100
SBC6S-C	#8 SOL	#6 SOL	#16 SOL	0.41	0.62	0.95	
SBC4S-C		#6 STR	#14 STR	0.45	0.69	0.98	
SBC3-C		#4 STR		0.58	0.81	1.16	
SBC2-C	#6 SOL	#2 STR	#14 STR	0.59	0.86	1.23	
SBC1/0-L	#4 SOL	1/0 STR		0.75	0.93	1.55	
SBC2/0-Q	#2 SOL	2/0 STR		0.79	1.05	1.72	
SBC250-Q	#1 SOL	250 kcmil	#8 STR	1.03	1.36	2.09	25

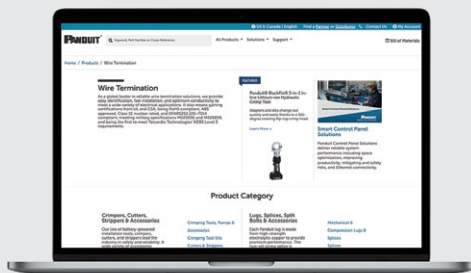

Like what you see? Want more?

Visit www.panduit.com for the full offering of Panduit products

www.panduit.com

UL LISTED CERTIFIED Split Bolt, Copper, Tin-Plated

For Specified Combinations of Copper and Aluminum Code Conductors

Type SBCT

- Made from high strength copper alloy to provide premium electrical and mechanical performance
- Tin-plated to inhibit corrosion and oxidation
- Offered with dual rating for use with aluminum or copper conductors
- Wide wire range-taking capability minimizes inventory requirements
- Nut hex provides correct fit with socket, box, or open end wrenches resulting in proper torquing of electrical connection
- Free floating pressure bar separates conductors of dissimilar materials for secure connection on a full range of conductor combinations
- UL Listed and CSA Certified for use up to 600V and UL temperature rated 90°C

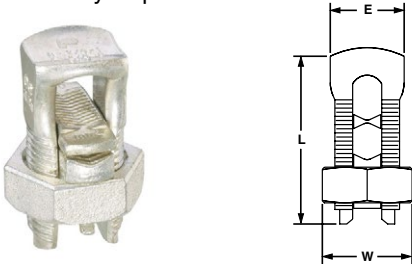

UL Listed and CSA Certified with Copper and Aluminum Conductors

Part Number	Copper and Aluminum Code Conductor			Figure Dimensions (In.)			Std. Pkg. Qty.
	Range of Equal Run and Tap		Min. Tap with One Max. Run	E	W	L	
	Min	Max					
SBCT2/0-Q	#2 SOL	2/0 STR	#8 STR	0.79	1.05	1.71	25

UL LISTED One-Hole, Straight Tongue, Barrel Post Lug

For Use with Copper Code Conductors

Type ML

- Made from high strength electrolytic copper to provide premium electrical and mechanical performance
- Compact design saves space
- Wide wire range-taking capability minimizes inventory requirements
- Inspection window to visually assure full conductor insertion
- Plated steel set screw provides high strength, durable electrical contact between conductor and connector
- Flat bottom allows for complete contact with mounting surface
- UL Listed for use up to 600V and temperature rated 90°C
- Tin plating is available, contact customer service

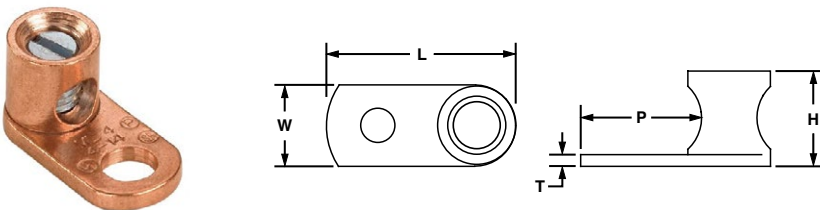

Part Number	Copper Conductor Size Range	Stud Hole Size (In.)	Hex Key Size (In.)	Figure Dimensions (In.)					Std. Pkg. Qty.
				L	W	H	T	P	
ML4-CY	#14 SOL – #4 STR	0.25	**	1.11	0.54	0.55	0.09	0.63	100
ML1/0-LY	#14 SOL – 1/0 STR	0.3125	0.25	1.54	0.73	0.79		0.80	50

**Uses slotted head set screw.



One-Hole, Single Piece, Straight Fixed Tongue Lug

For Use with Stranded Copper Code Conductors

Type CXS

- Made from a single piece of high strength electrolytic copper to provide premium electrical and mechanical performance
- Patented one piece design. Provides premium electrical and mechanical
- Wide wire range-taking capability minimizes inventory requirements
- Serrations incorporated in barrel of connector to provide premium wire pullout strength of wire termination
- Plated, fillister head, steel set screw provides high strength, durable electrical contact between conductor and connector
- cULus Listed for use for up to 600V and temperature rated to 90 C where applicable

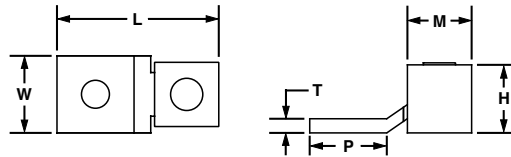

Part Number	Copper Conductor Size Range	Stud Hole Size (In.)	Figure Dimensions (In.)					Std. Pkg. Qty.
			L	W	H	T	M	
CXS35-36-C	14 AWG – 6 AWG	0.1875	1.08	0.38	0.39	0.05	0.47	100
CXS70-14-C	14 AWG – 4 AWG	0.25	1.28	0.5	0.5	0.06	0.53	100



One-Hole, Offset Floating Tongue Lug

For Use with Stranded Copper Code Conductors

Type CB

- Made from high strength electrolytic copper to provide premium electrical and mechanical performance
- Wide wire range-taking capability minimizes inventory requirements
- Internal pressure bar and V-bottom collar provide uniform clamping force on conductor to assure positive contact between conductor and connector
- Inspection window to visually assure full conductor insertion
- Plated steel set screw provides high strength, durable electrical contact between conductor and connector
- cULus Listed for use up to 600V and temperature rated to 90°C where applicable

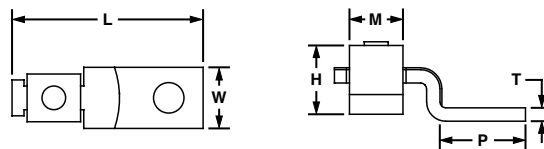

Part Number	Conductor Size Range	Current Rating (Amps)	Stud Hole Size (In.)	Hex Size (In.)	Figure Dimensions (In.)						Std. Pkg. Qty.
					L	W	H	T	P	M	
CB70-14-CY	#8 AWG – #2 AWG, (1) #8 AWG with (1) #4 AWG, (1) #8 AWG with (1) #6 AWG	90	0.25	**	1.55	0.47	0.64	0.08	0.80	0.50	100



One-Hole, Single Barrel Lug

For Use with Stranded Aluminum or Copper Code Conductors

Type LAMA

- The Aluminum Mechanical Connector Lugs, one-hole aluminum, single barrel, is made from extruded aluminum alloy to provide premium electrical and mechanical performance for wide wire range-taking capability that helps minimize inventory requirements
- The plated steel or aluminum set screw provides a durable electrical contact between conductor and connector
- UL Listed and CSA Certified for use up to 600V and UL temperature rated 90°C
- Tin-plated to inhibit corrosion

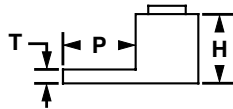
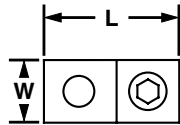

BEST SELLER

Part Number	Conductor Size Range	Stud Hole Size (In.)	Hex Key Size (In.)	Figure Dimensions (In.)					Std. Pkg. Qty.
				L	W	H	T	P	
LAMA6-14-QY	#14 AWG – #6 AWG	0.25	**	1.06	0.50	0.50	0.09	0.68	25
LAMA2-14-QY	#14 AWG – #2 AWG		**	1.16		0.55	0.10	0.69	
LAMA1/0-14-QY	#14 AWG – 1/0 AWG		**	1.47	0.62	0.79	0.19	0.85	
LAMA2/0-14-QY	#14 AWG – 2/0 AWG		0.1875						
LAMA250-56-QY	#6 AWG – 250 kcmil	0.3125	0.3125	2.01	1.00	1.13	0.25	0.99	
LAMA350-38-QY	#6 AWG – 350 kcmil	0.375		2.25	1.13	1.25		1.12	

The use of Panduit oxide inhibiting joint compound (CMP-100) is recommended for pad to pad and conductor connections.
 **Uses slotted head set screw.



One-Hole, Two-Barrel Lug

For Use with Stranded Aluminum or Copper Code Conductors

Type LAM2A

- Dual barrel provides termination of two conductors
- Made from high strength, extruded aluminum alloy to provide premium electrical and mechanical performance
- Tin-plated to inhibit corrosion
- Wide wire range-taking capability minimizes inventory requirements
- Inspection window to visually assure full conductor insertion
- Plated steel or aluminum set screw provides high strength, durable electrical contact between conductor and connector
- UL Listed and CSA Certified for use up to 600V and temperature rated 90°C
- Available with NEMA hole sizes and spacing

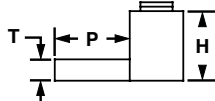
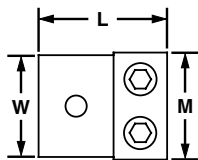

Part Number	Conductor Size Range	Stud Hole Size (In.)	Hex Key Size (In.)	Figure Dimensions (In.)						Std. Pkg. Qty.
				L	W	H	T	P	M	
LAM2A1/0-14-6Y	#14 AWG – 1/0 AWG	0.25	**	1.47	1.13	0.78	0.19	0.85	1.13	6
LAM2A250-38-6Y	#6 AWG – 250 kcmil	0.375	0.375	2.56	1.50	1.19	0.25	1.56	1.64	
LAM2A600-12-6Y	#2 AWG – 600 kcmil	0.5		3.19	2.00	1.56	0.44	1.81	2.38	

The use of Panduit oxide inhibiting joint compound (CMP-100) is recommended for pad to pad and conductor connections.
 **Uses slotted head set screw.

www.panduit.com



In-Line Splicer/Reducer with Clear Insulation

For Use with Aluminum or Copper Code Conductors

Type PISR

- Flexible design – can be used as a splice or reducer
- Dual rated for use with copper or aluminum conductors
- Made from high strength, extruded aluminum alloy to provide premium electrical and mechanical performance
- Insulated with clear PVC to eliminate the need for taping and allow for visual inspection of the complete conductor insertion
- Each port pre-filled with oxide inhibiting joint compound seals out air and moisture to deter surface oxidation
- Wide wire range-taking capability minimizes inventory requirements
- Plated steel or aluminum set screw provides high strength, durable electrical contact between conductor and connector
- UL Listed and CSA Certified for use up to 600V and UL temperature rated 90°C

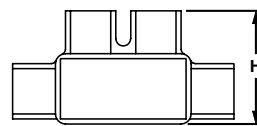
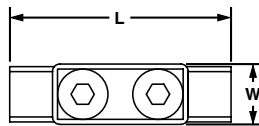

Part Number	Conductor Size Range	Figure Dimensions (In.)			Std. Pkg. Qty.
		L	W	H	
PISR250-1	250 kcmil – #10 AWG STR, #8 AWG SOL – #10 AWG SOL	4.00	1.25	2.24	1



Multi-Tap Connector with Clear Insulation, Single-Sided

For Use with Aluminum or Copper Code Conductors

Type PCSB-S

- The Multi-Tap Mechanical Connectors have a flexible design that can be used as a tap, splice, or dead-end connector
- Made from high strength, extruded aluminum alloy to provide premium electrical and mechanical performance
- Insulated with clear PVC to eliminate the need for taping and allow for visual inspection of the complete conductor insertion
- UL Listed and CSA Certified for use up to 600V and temperature rated to 90°C

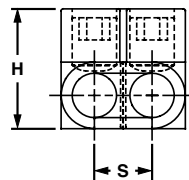
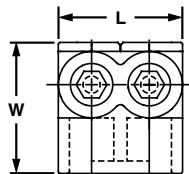

Part Number	Conductor Size Range	No. of Ports	Figure Dimensions (In.)				Hex Key Size (In.)	Std. Pkg. Qty.
			L	W	H	S		
BEST SELLER PCSB4-2S-12Y	#4 – #14 AWG STR	2	1.23	1.25	1.25	0.53	0.125	12
PCSB4-3S-12Y	#10 – #14 AWG SOL	3	1.76					
BEST SELLER PCSB2/0-2S-6	2/0 – #14 AWG STR	2	1.52	1.31	1.38	0.67	0.1875	6
PCSB2/0-3S-6Y	#10 – #14 AWG SOL	3	2.19					
PCSB250-2S-6Y	250 kcmil – #10 AWG STR	2	2.03	2.00	2.13	0.94	0.3125	

www.panduit.com



Multi-Tap Connector with Clear Insulation, Single-Sided

For Use with Aluminum or Copper Code Conductors

Type PCSB

- Flexible design – can be used as a tap, splice, or dead end connector
- Body made from high strength, extruded aluminum alloy to provide premium electrical and mechanical performance
- Insulated with clear PVC to eliminate the need for taping and allow for visual inspection of the complete conductor insertion
- Each port pre-filled with oxide inhibiting joint compound seals out air and moisture to deter surface oxidation
- Wide wire range-taking capability minimizes inventory requirements
- Dual-sided entry allows offset and opposite entry for primary and secondary conductors
- Plated steel or aluminum set screw provides high strength, durable electrical contact between conductor and connector
- UL Listed and CSA Certified for use up to 600V and temperature rated 90°C

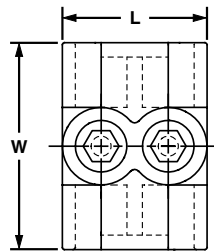

Part Number	Conductor Size Range	No. of Ports	Figure Dimensions (In.)				Hex Key Size (In.)	Std. Pkg. Qty.
			L	W	H	S		
PCSB4-2-12Y	#4 – #14 AWG STR #10 – #14 AWG SOL	2	1.23	1.50	1.25	0.53	0.125	12
PCSB4-4-6Y		4	2.29					6
PCSB4-8-4Y		8	4.41					4
PCSB2/0-2-12	2/0 – #14 AWG STR #10 – #14 AWG SOL	2	1.52	1.56	1.38	0.67	0.1875	12
PCSB2/0-4-6		4	2.86					6
PCSB250-2-6Y	250 kcmil – #10 AWG STR	2	2.03	2.63	2.13	0.94	0.3125	6
PCSB250-3-6Y		3	2.97					

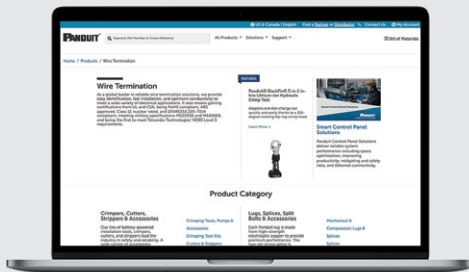

Like what you see? Want more?

Visit www.panduit.com for the full offering of Panduit products

www.panduit.com

Contour Crimp™ Controlled Cycle Tools

- Controlled cycle mechanism assures high quality, consistent terminations
- Ergonomic tool design assures operator comfort, safety, and performance
- Polypropylene handles provide chemical resistance and a cushioned, non-slip grip
- Tools incorporate multiple die pockets in rotating die wheel with push-button lockout



CT-1700



CT-1701

Part Number	Part Description	Std. Pkg. Qty.
CT-1700	The CT-1700 Contour Crimp Controlled Cycle Tool provides a controlled cycle mechanism assuring a high quality, consistent terminations while an ergonomic tool design ensures operator comfort, safety, and performance. The polypropylene handles provides chemical resistance and a cushioned, non-slip grip. The integrated, color coated, rotating five-pocket crimp die included a push-button lockout.	1
CT-1701	The CT-1701 Controlled Cycle Tool features a controlled-cycle crimping ratchet mechanism along with a ergonomic design which provides low handle effort for crimping.	

Uni-Die™ Quad-Point, Dieless, Manual Hydraulic, 6.2 Ton, Crimping Tool

- Quad-point indent crimping feature with patented centering system, no dies required
- Cushioned grips prevent hands from slipping on tool, reduces fatigue
- Provides UL Listed and CSA Certified wire range-taking capability on Panduit® Pan-Lug™ Copper Lugs and Splices, minimizes connector inventory and saves cost
- Audible “pop-off” valve indicates crimp completion
- Closed head with bolt interlock, flip top style, rotatable 360 degrees
- Light weight, high quality aluminum housing and crimp head, results in lightweight tool and ease of operation
- 2-stage hydraulic system with rapid advance, double action handle and power stroke
- Automatic retraction when operation is complete
- Manual retraction if needed.
- Uses environmentally-friendly hydraulic oil, biodegradable



Part Number	Part Description	Std. Pkg. Qty.
CT-980	The CT-980 Uni-Die™ Dieless Crimping Tool provides a cushioned grip to help prevent hands from slipping on the tool and reduce fatigue. UL Listed and CSA Certified wire range-taking capability on Panduit® Pan-Lug™ Copper Lugs and splices for #4 AWG – 750 kcmil copper code conductor.	1



Uni-Die™ Dieless, Lithium-Ion Battery Powered, In-Line, Hydraulic, 3.4 - 6.7 Ton, Crimping Tool



- 2-stage telescoping indenter identifies crimp force required for size of connector to be terminated
- Integrated pressure measurement with visual and audible signals if full crimp force is not attained
- In-Line, balanced ergonomic tool design mitigates repetitive stress injuries to operators
- One-button operating concept for controlling all tool functions
- 2-stage hydraulic system with rapid advance and power stroke, 2-7 second crimp cycle time.
- Manual retract stop with “teach in” sets position of piston stop for multiple crimping operations
- Multi-function LED for maintenance display, battery charge status indicator and for data transmission via USB adapter
- Includes two Makita* 18 V Li-ion, 3 Ah batteries with fast, 22 minute charge time and battery charger
- 300 crimps on 300 kcmil (150mm²) copper code lug per battery charge

Part Number	Part Description	Std. Pkg. Qty.
CT-3980	The CT-3980 BlackFin® Battery Powered Crimp Tool crimps easily with a 360-degree rotating flip-top crimp head since adapters can change out quickly. The crimp tool has a force of 6.7 tons and crimps most Pan-Term® terminals, splices, disconnects, ferrules, and some copper lugs. This tool meets OSHA mandated electrical and mechanical product safety requirements for handheld and motor-operated electric tools.	1

*Makita is a registered trademark of Makita Corporation.



Uni-Die™ Quad-Point, Dieless, Lithium-Ion Battery Powered Hydraulic, 6.2 Ton, Pistol Grip, Crimping Tool



- Integrated pressure measurement with visual and audible signals if full crimp force is not attained
- Quad-point indent crimping feature with patented centering system, no dies required
- Provides UL Listed and CSA Certified wire range-taking capability on Panduit® Pan-Lug™ Copper Lugs and Splices, minimizes connector inventory and saves cost
- One-button operating concept for controlling all tool functions
- 2-stage hydraulic system with rapid advance and power stroke, 3-6 second crimp cycle time
- Rotating flip-top crimp head, rotates 350 degrees
- Automatic retraction when crimping is complete
- Multi-function LED for maintenance display, battery charge status indicator and for data transmission via USB adapter
- Includes two Makita* 18 V Li-ion, 3 Ah batteries with fast, 22 minute charge time and battery charger
- 300 crimps on 300 kcmil (150mm²) copper code lug per battery charge

Part Number	Part Description	Std. Pkg. Qty.
CT-2980/ST	The CT-2980/ST BlackFin® Battery Powered Crimping Tool crimps with just the touch of a button. Wires can quickly and easily terminate with a 360-degree rotating flip-top crimp head. The crimp tool has a force of 6.2 tons and crimps most Pan-Term® terminals, splices, disconnects, ferrules, and some copper lugs. This tool meets OSHA mandated electrical and mechanical product safety requirements for handheld and motor-operated electric tools.	1

*Makita is a registered trademark of Makita Corporation.

Die Type, Manual Hydraulic, 12 Ton, Crimping Tool

- High quality, durable tool construction provides long-term dependability
- Cushioned grip prevents hands from slipping on tool, reduces fatigue



- Uses Panduit [CD-920](#) and [CD-930](#) color-coded crimping dies to provide easy matching of crimping die to connector
- Audible “pop-off” valve indicates crimp completion
- Open “C” head, rotatable 350 degrees
- 2-stage hydraulic system: rapid advance, double action handle and power stroke
- Automatic retraction when operation is complete
- Manual retraction operation if needed
- Uses environmentally-friendly hydraulic oil, biodegradable

Part Number	Part Description	Std. Pkg. Qty.
CT-920	The CT-920 Manual Hydraulic Crimp Tool is a hand-operated and light weight hydraulic crimping tool that is made of high quality aluminum that provides long-term dependability. The cushion grip prevents hands from slipping and reduces worker fatigue. This tool crimps most Pan-Term® terminals, splices, disconnects, ferrules, and some copper lugs.	1

Die Type, Lithium-Ion Battery Powered, Hydraulic, 6.7 Ton, In-Line Crimping Tool



- Integrated pressure measurement with visual and audible signals if full crimp force is not attained
- In-Line, balanced ergonomic tool design mitigates repetitive stress injuries to operators
- One-button operating concept for controlling all tool functions
- 2-stage hydraulic system with rapid advance and power stroke, 2-5 second crimp cycle time
- Rotating, flip-top, crimping head, rotates 350 degrees
- Automatic position control sets position of piston for multiple crimpings
- Multi-function LED for maintenance display, battery charge status indicator and for data transmission via [CT-USB](#) adapter & [FINS](#) software
- Includes two Makita* 18V Li-ion, 3.0 Ah batteries with fast 22 minute charge time and battery charger
- Approximately 300 crimps on a 300 kcmil (150mm²) Copper Code lug per battery charge

Part Number	Part Description	Std. Pkg. Qty.
CT-3001/ST	The CT-3001/ST BlackFin® Battery Powered Crimp Tool crimps easily with a 360-degree rotating flip-top crimp head since adapters can change out quickly. The crimp tool has a force of 6.7 tons and crimps most Pan-Term® terminals, splices, disconnects, ferrules, and some copper lugs. This tool meets OSHA mandated electrical and mechanical product safety requirements for handheld and motor-operated electric tools.	1

*Makita is a registered trademark of Makita Corporation.

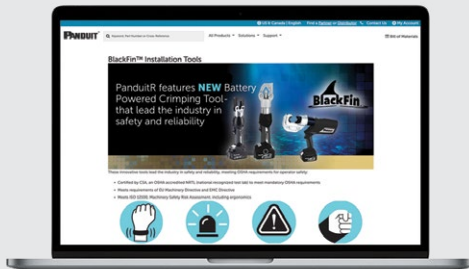

Like what you see? Want more?

Visit www.panduit.com for the full offering of Panduit products

www.panduit.com

Die Type; Crimp, Cut, Punch, 3 in 1 Lithium-Ion Battery Powered Hydraulic, 6.7 Ton, In-Line Tool

- Universal tool design operates using crimp dies, wire and threaded rod cutting blades and hole punch adapter sold separately
- In-Line, balanced ergonomic tool design mitigates repetitive stress injuries to operators
- One-button operating concept for controlling all tool functions



- 2-stage hydraulic system with rapid advance and power stroke, 7-9 second crimp cycle
- Rotating, flip-top tool head rotates 350 degrees.
- Manual retract stop with “teach in” sets position of piston for multiple crimping operations
- Multi-function LED for maintenance display, battery charge status indicator and for data transmission via [USB](#) adapter & [FINS](#) software
- Includes two Makita* 18V Li-ion, 3.0 Ah batteries with fast, 22 minute charge time and battery charger
- 300 crimps on a 300 kcmil (150mm²) Copper Code lug per battery charge.

Part Number	Part Description	Std. Pkg. Qty.
CT-3001/CCP	The CT-3001/CCP BlackFin® Battery Powered Crimp Tool designed to operate using crimp dies, cutting blades, and hole punch adapters. The low profile, flip-top crimp head rotates 355 degrees and crimps up to 6.7 tons. This tool crimps most Pan-Term® terminals, splices, disconnects, ferrules, and some copper lugs while meeting OSHA mandated electrical and mechanical product safety requirements for handheld and motor-operated electric tools.	1

*Makita is a registered trademark of Makita Corporation.

Die Type, Lithium-Ion Battery Powered Hydraulic, 12 Ton, Pistol Grip, Crimping Tool

- Integrated pressure measurement with visual and audible signals not meeting full crimp pressure
- Open “C” head design with 1.65" opening, rotates 350 degrees
- One-button operating concept for controlling all tool functions



- 2-stage hydraulic system with rapid advance and power stroke, 8-9 second crimp cycle time
- Automatic retraction when crimping is complete
- Automatic position control sets piston stop for multiple crimping operations
- Multi-function LED for maintenance display, battery charge status indicator and for data transmission via [USB](#) adapter and [FINS](#) software downloadable from Panduit website
- Includes two Makita* 18V Li-ion, 3.0 Ah batteries with fast, 22 minute charge time and Makita* battery charger
- Approximately 115 crimps on 300 kcmil (150 mm²) copper lug per battery charge

Part Number	Part Description	Std. Pkg. Qty.
CT-2931/ST	The CT-2931/ST BlackFin® Battery Powered Crimping Tool crimps with just the touch of a button. Wires can quickly and easily be terminate with a 355-degree rotating flip-top crimp head. The crimp tool has a force of 12 tons and crimps most Pan-Term® terminals, splices, disconnects, ferrules and some copper lugs. This tool meets OSHA mandated electrical and mechanical product safety requirements for handheld and motor-operated electric tools.	1

*Makita is a registered trademark of Makita Corporation.

CD-2001 & KC22 Crimping Dies



- Color-coded to provide easy matching to color-coding marked on connectors
- Embosses die index number on connector barrels to provide post crimp inspection
- Part number permanently marked on crimping die for easy identification
- Die adapters for CD-2001 dies included with [CT-3001/ST](#) and [CT-3001/CCP](#) series tools
- CD-2001 dies provide a circumferential crimp results in terminations with premium electrical and mechanical performance

Part Number	Terminates Panduit Copper Lugs and Splices	Copper Code Conductor Size	Copper Code and Flex Conductor Size for LCAX, LCBX, LCDX, LCCX	Copper Metric Class 2R Conductor Size	Copper Metric Class 5f & 6f Conductor Size	Std. Pkg. Qty.
	Copper Die Color and Die No.					
CD-2001-8-SET	Red P21	#8 AWG	#8 AWG	10mm ²	10mm ² 16mm ²	1
CD-2001-6-SET	Blue P24	#6 AWG	#6 AWG	16mm ²	—	
CD-2001-4-SET	Gray P29	#4 AWG STR #3 AWG STR #2 AWG SOL	#4 AWG #5, #4, #3 AWG DLO flex	25mm ² 35mm ²	25mm ²	
CD-2001-2-SET	Brown P33	#2 AWG	#2 AWG	—	35mm ²	
CD-2001-1-SET	Green P37	#1 AWG	#1 AWG	50mm ²	50mm ²	
CD-2001-1/0-SET	Pink P42	1/0 AWG	1/0 AWG	—	—	
CD-2001-2/0-SET	Black P45	2/0 AWG	2/0 AWG	70mm ²	70mm ²	
CD-2001-3/0-SET	Orange P50	3/0 AWG	3/0 AWG	—	95mm ²	
CD-2001-4/0-SET	Purple P54	4/0 AWG	4/0 AWG	95mm ²	—	
CD-2001-250-SET	Yellow P62	250 kcmil	250 kcmil flex 262 kcmil flex	120mm ²	—	
CD-2001-300-SET	White P66	300 kcmil	—	150mm ²	—	
CD-2001-350-SET	Red P71	350 kcmil	300 kcmil flex 313 kcmil flex	—	—	
CD-2001-400-SET	Blue P76	400 kcmil	350 kcmil flex 373 kcmil flex	185mm ²	—	
CD-2001-500-SET	Brown P87	500 kcmil	—	240mm ²	—	
KC22-600B*	Green	600 kcmil	—	—	—	

*[KC22](#) die provides hex style crimp, requires [UA22](#) die adapter for use in [CT-3001/CCP](#) series tools.

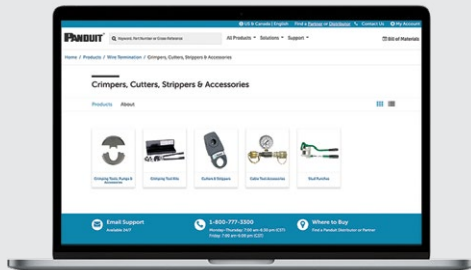

**Like what you see?
Want more?**

Visit www.panduit.com for the full offering of Panduit products

www.panduit.com

CD-920 Crimping Dies

- Color-coded for easy matching to color-coding marked on connectors
- Embosses die index number on connector barrels for post crimp inspection
- Part number permanently marked on crimping die for easy identification
- Provides circumferential crimp results in terminations with premium electrical and mechanical performance



CD-920

Part Number	Used to Install Panduit Compression Lug and Splice Sizes							Std. Pkg. Qty.
	Copper Die Color and Die No.	Copper Code Conductor Size	Copper Code and Flex Conductor Size for LCAX, LCBX, LCDX, LCCX	Copper Flex Conductor Size for LCAF, LCCF, SCSF	Copper Metric Class 2R Conductor Size	Aluminum Die Color and Die No.	Aluminum Code Conductor Size	
CD-920-8	Red P21	#8 AWG	#8 AWG	#8 AWG	10mm ²	—	—	1
CD-920-6	Blue P24	#6 AWG	#6 AWG	#6 AWG	16mm ²	—	—	
CD-920-4	Gray P29	#4 AWG STR #3 AWG STR #2 AWG SOL	#4 AWG #5, #4, #3 AWG DLO flex	#4 AWG	25mm ² 35mm ²	Gray P29	#6 AWG	
CD-920-2	Brown P33	#2 AWG	#2 AWG	#2 AWG	—	—	—	
CD-920-1	Green P37	#1 AWG	#1 AWG	—	50mm ²	Green P37	#4 AWG	
CD-920-1/0	Pink P42	1/0 AWG	1/0 AWG	#1 AWG	—	Pink P42	#2 AWG	
CD-920-2/0	Black P45	2/0 AWG	2/0 AWG	1/0 AWG	70mm ²	Gold P45	#1 AWG	
CD-920-3/0	Orange P50	3/0 AWG	3/0 AWG	2/0 AWG	—	Tan P50	1/0 AWG	
CD-920-4/0	Purple P54	4/0 AWG	4/0 AWG	3/0 AWG	95mm ²	Olive P54	2/0 AWG	
CD-920-250	Yellow P62	250 kcmil	250 kcmil flex 262 kcmil flex	4/0 AWG	120mm ²	Ruby P62	3/0 AWG	
CD-920-300	White P66	300 kcmil	—	250 kcmil 262 kcmil	150mm ²	White P66	4/0 AWG	
CD-920-350	Red P71	350 kcmil	300 kcmil flex 313 kcmil flex	300 kcmil 313 kcmil	—	Red P71	250 kcmil	
CD-920-400	Blue P76	400 kcmil	350 kcmil flex 373 kcmil flex	350 kcmil 373 kcmil	185mm ²	Blue P76	300 kcmil	
CD-920-500	Brown P87	500 kcmil	444 kcmil flex 450 kcmil flex	444 kcmil 450 kcmil	240mm ²	Brown P87	350 kcmil	
CD-920-600	Green P94	600 kcmil	—	—	300mm ²	Green P94	400 kcmil	
CD-920-500A	P99	500 kcmil	500 kcmil flex 535 kcmil flex 600 kcmil flex	500 kcmil 535 kcmil	—	Pink P99	500 kcmil	
CD-920-750	Black P106	750 kcmil	—	646 kcmil	400mm ²	Black P106	600 kcmil	

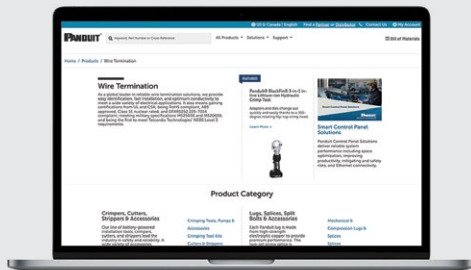

**Like what you see?
Want more?**

Visit www.panduit.com for the full offering of Panduit products

www.panduit.com

cUL^{us} Telecommunications Grounding Busbars

Type GB

- The Telecommunications Grounding Busbars meets BICSI and ANSI/TIA-607-D (rev. 2019) requirements for network systems grounding applications
- Made of high conductivity copper and tin-plated to inhibit corrosion
- Comes pre-assembled with brackets and insulators attached for a quick installation
- The insulators provide 600V of insulation and use of Panduit self-laminating laser/ink jet labels to identify busbars



TGB



TMGB

Part Number	Bar Size	No. of Mounting Positions		Std. Pkg. Qty.
		0.25" Stud Hole with 0.625" Hole Spacing	0.375" Stud Hole with 1" Hole Spacing	

Telecommunications Grounding Busbars (TGB)

BEST SELLER	GB2B0304TPI-1	0.25" x 2" x 10"	4	3	1
BEST SELLER	GB2B0306TPI-1	0.25" x 2" x 12"	6		
	GB2B0312TPI-1	0.25" x 2" x 20"	12		

Telecommunications Main Grounding Busbars (TMGB)

BEST SELLER	GB4B0612TPI-1	0.25" x 4" x 12"	12	6	1
	GB4B1028TPI-1	0.25" x 4" x 24"	28	10	

cUL^{us} NEMA Hole Pattern Grounding Busbars

Type GBN

- Provided with standard NEMA hole pattern spacing
- Made of high conductivity copper and tin-plated to inhibit corrosion
- Come pre-assembled with brackets and insulators attached for quick installation
- Insulators provide 600V of insulation



Part Number	Bar Size	No. of Mounting Positions		Std. Pkg. Qty.
		0.5" Stud Hole with 1.75" Hole Spacing		
GB4N0007TPI-1	0.25" x 4" x 12"	7		1
GB4N0016TPI-1	0.25" x 4" x 24"	16		
GB4N0024TPI-1	0.25" x 4" x 36"	24		

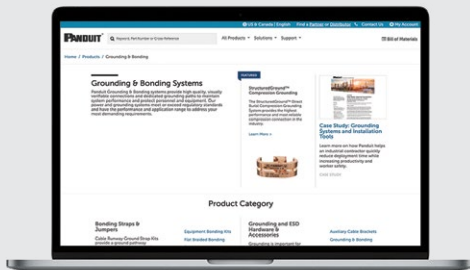

Like what you see? Want more?

Visit www.panduit.com for the full offering of Panduit products

www.panduit.com



Universal Ground Bars

For Use with Stranded and Solid Copper Conductors

- The Universal Ground Bars securely terminates the main equipment grounding conductor with a compression or mechanical connector in any control panel or enclosure
- Accepts #14 – #4 AWG wire in wire ports and up to a 2/0 AWG main equipment grounding conductor with a compression or mechanical connector
- Several mounting options are available, including bonding stand-offs, isolation stand-offs, and direct mounting to a panel



Part Number	Number of Ports	Wire Port Wire Range AWG	1/4-28 Wire Port Screw Qty	Figure Dimensions in (mm)				
				Length	Width at Top	Width at Base	Height	Mounting Holes to Panel Width
BEST SELLER UGB2/0-414-6	6	14 AWG – 4 AWG	8	4.92 (125.0)	0.62 (15.7)	0.44 (11.1)	.48 (12.2)	2.37 (61.1)
BEST SELLER UGB2/0-414-12	12		14	8.28 (210.3)				5.73 (145.4)
BEST SELLER UGB2/0-414-18	18		20	11.64 (295.7)				9.09 (230.8)

Accessories

Part Number	Part Description
BEST SELLER UGB-B-SO	Universal ground bar bonding stand-offs; includes two stand-offs and hardware; 2.34" (59.3mm) length, 0.63" (15.9mm) width, 0.75" (19.1mm) height
BEST SELLER UGB-IN-SO	Universal ground bar isolation stand-offs; includes two stand-offs and hardware; 1.57" (40mm) length, 0.59" (15.0mm) width, 0.98" (25.0mm) height



UGB-B-SO



UGB-IN-SO



Grounding Busbar Kit



- The RGRB19U Grounding Busbar is tin-plated with twenty holes designed for flexibility in mounting with twenty #12-24 x 0.5" hex head screws installed

Grounding Busbar Kits for Threaded Rail Fasteners

Part Number	Part Description	Std. Pkg. Qty.
BEST SELLER RGRB19U	Grounding busbar; 19" (483mm) length; tin-plated; twenty holes arranged for flexibility in mounting with twenty #12-24 x 0.5" hex head screws installed; mounting hole sets have 0.625" (15.9mm) spacing; provided with two each #12-24 x 0.5", M6 x 12mm thread-forming screws, and two #12 flat washers for mounting.	1



Grounding Busbar

Type RGRB



- Provide the common grounding point within the cabinet
- Can be positioned anywhere on the rack or cabinet
- Made from high-connectivity copper unplated
- #6-32 tapped holes with 1" spacing

Part Number	Part Description	Std. Pkg. Qty.
RGRB19B	Grounding Busbar provides an electrically continuous grounding location for jumpers. Optimized for installation of 19RU's within a rack or cabinet.	1



Grounding Busbar Kits

- Provide the common grounding point within the cabinet
- Optimized for installation on 19" racks or cabinets that meet EIA-310
- Can be positioned anywhere on the rack or cabinet
- Available pre-assembled with twenty mounting screws for quick and easy installation
- Engineered to comply with US and International grounding requirements

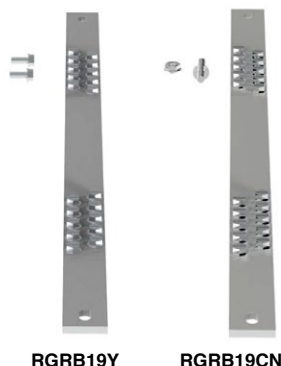

RGRB19Y

RGRB19CN

Part Number	Part Description	Std. Pkg. Qty.
Grounding Busbar Kit for Threaded Rail Fasteners		
RGRB19Y	Grounding busbar; 19" (483mm) length; tin-plated copper; fourteen holes arranged for flexibility in mounting; provided with two each #12-24 x 0.5" and M6 x 12mm thread-forming screws.	1
Grounding Busbar Kit for Cage Nut Rail Fasteners		
RGRB19CN	Grounding busbar; 19" (483mm) length; tin-plated copper; twenty holes arranged for flexibility in mounting with twenty #12-24 x 0.5" hex head screws installed; mounting hole sets have 0.625" (15.9mm) spacing; provided with two cage nut bonding studs and four #12-24 bonding nuts.	1



Grounding Strip Kit

- The RGS134-1Y Grounding Strip bonds up to 45 RU per Rack with Threaded Rail Fasteners with an EIA Universal Mounting Hole Pattern
- Engineered to Comply with US and International Grounding Requirements



BEST SELLER

Part Number	Part Description	Std. Pkg. Qty.
RGS134-1Y	Grounding strip; 78.65" (2m) length; .67" (17mm) width; .05" (1.27mm) thickness; provided with .16 oz. (5cc) of antioxidant, one grounding sticker and three each #12-24 x 0.5" and M6 x 12mm thread-forming screws.	1



Grounding Strip Kit for Cage Nut Rail Fasteners

- Bonds up to 45 RU per rack
- EIA Universal mounting hole pattern
- Engineered to comply with US and International grounding requirements



Part Number	Part Description	Std. Pkg. Qty.
RGS134B-1	Grounding strip; 78.70" (2m) length; .67" (17mm) width; .05" (1.27mm) thickness; provided with .16 oz. (5cc) of antioxidant, one grounding sticker, three cage nut bonding studs, eight #12-24 bonding nuts and three strip clips.	1



Flat Braided Bonding Straps - One-Hole, Insulated

Type BS

- Used to electrically bond enclosure doors, motors, and machine frames in the construction of control panels or machine structures
- Flat ferrule end design helps to reduce the effects of EMI (Electromagnetic Interference)
- Available with internationally recognized green and yellow insulation for grounding application
- Made of high conductivity copper and tin-plated to inhibit corrosion
- Seamless ferrule ends provide mechanical strength for improved reliability
- cULus Listed - UL467 for Bonding Applications Only

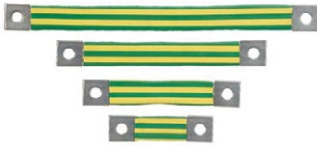

Part Number	Conductor Size	Length In. (mm)	Width In. (mm)	Thickness In. (mm)	Ferrule Length In. (mm)	Stud Hole Size In. (mm)	Std. Pkg. Qty.
BS100845	#4 AWG	8.00 (203.2)	1.06 (27.0)	0.13 (3.3)	1.00 (25.4)	0.375 (M10)	1



Equipment Bonding Jumper Kit

- The RGCBNJ660P22 Equipment Bonding Jumper Kit bonds the rack or cabinet to the MCBN
- Engineered to comply with US and International grounding requirements
- HTAP is UL Listed and CSA Certified for applications up to 600V when crimped with Panduit and specified competitor crimping tools, and Panduit crimping dies



BEST SELLER

Part Number	MCBN Conductor Size AWG	Part Description	Std. Pkg. Qty.	Std. Ctn. Qty.
RGCBNJ660P22	HTCT2-2-1	#6 AWG (16mm ²) jumper; 60" (1.52m) length; 45° bent lug on grounding strip side; provided with .16 oz. (5cc) of antioxidant, two each #12-24 x 0.5", M6 x 12mm, #10-32 x 0.5" and M5 x 12mm thread-forming screws and a copper compression HTAP* for connecting to the MCBN.	1	10

*HTAPs also sold separately.

Armored Cable Grounding Kit

- Provides a secure bond to the armor sheath on indoor and indoor/outdoor fiber optic cables at both cassette and enclosure ends
- Worm-gear design evenly distributes forces across the armor
- Made from steel and tin-plated copper for chemical compatibility with common armor for long-term reliability
- Black insulating cover protects and hides the connection from incidental contact to prolong connection integrity
- Complies with industry requirements ensuring a high level of reliability and safety



Part Number	Part Description	Std. Pkg. Qty.
ACG24K	#6 AWG (16mm ²) jumper for armored cable diameter up to 0.84" (21.3mm); 24" (609.6mm) length; factory terminated on one end with LCC6 two-hole copper compression lug and the other end with grounding terminal; provided with two each #12-24 and M6 thread-forming screws and a black polypropylene terminal cover.	1



Retrofit Rack Grounding Kit

- Provide a dedicated ground system to maintain system performance and protect network equipment when equipment is already installed
- Optimized for installation on 19" racks that meet EIA-310, with functioning equipment, and are deployed in the field

- Provide a complete system of matched components that can be easily selected to save cost and labor
- Thread-forming screws eliminate the need to manually remove paint from the rack
- Engineered to comply with US and International grounding requirements

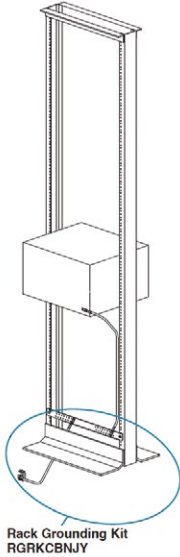

Busbar and Jumper Kit

Part Number	Part Description	Std. Pkg. Qty.
RGRKCBNJY	Rack grounding kit to ground the rack; includes one RGRB19U busbar, one HTCT250-2-1_HTAP , and one RGREJ696Y grounding jumper.	1

PATENTED

Green Bonding Cage Nut Kit

- The CNBK High Carbon Steel Bonding Cage Nut Kit creates an electrical bond between the mounting rails and equipment that conforms to EIA-310 specifications for racks and cabinets

- Made from high carbon steel and installed with a Phillips, flat blade, or nut screwdriver



BEST SELLER

Part Number	Part Description	Std. Pkg. Qty.
CNBK	Green bonding cage nut, includes 50 #12-24 bonding cage nuts (.06 – .11 thick panel) and 50 #12-24 x 0.5" bonding screws with #2 Phillips/slotted combo hex head (use 0.3125" or 8mm socket).	1

PATENTED

Bonding Hardware Kit

- Patented bonding hardware kits incorporate paint piercing serrations to create a bond point between the rack or cabinet and painted patch panels, mounted equipment, servers, busbars, and jumpers

- Thread-forming, provide a bond to the rack or cabinet by removing paint from holes and minimizing metal shavings
- Green color-coding to indicate bonding application



Bonding Stud Kits for Threaded Rail Fasteners

Part Number	Part Description	Std. Pkg. Qty.
TRBSK	Bonding stud kit for threaded #12-24 rail fasteners; includes 25 bonding studs and 50 bonding nuts.	1



Auxiliary Cable Bracket

- Bonds ladder rack, wire basket and Panduit® Wyr-Grid® System sections together without drilling holes
- Supports grounding conductors in the telecommunications room, allows separation of grounding conductors from other cables

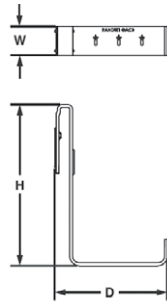

- Holds up to four conductors in sizes up to 750 kcmil
- Bonds to all 1" and 2" ladder rack rails
- Paint piercing teeth provide electrical continuity between cable pathway sections while minimizing debris
- Front and back mounting screw options allow easy installation and visual inspection
- GACB-2 can be mounted above or below the cable pathway system for flexibility
- Brackets meet TIA-607-C

Part Number	Part Description	Std. Pkg. Qty.	Std. Ctn. Qty.
GACB-2	Auxiliary cable bracket; 1.63" (41.4mm) W, 3.95" (100.3mm) H; 5.22" (132.6mm) D; provided with one mounting screw.	1	10



Code/Flex Conductor HTAP

For Making Parallel and Multiple Tap Connections on Code and Flex Conductors

Type HTCT

- The HTCT250-2-1 Compression Connector Tap used to tap into continuous conductors as a splice or pig tailing
- Each HTAP terminates a wide range of conductor sizes and combinations of code and flex conductors Class G, H, I, and Diesel Locomotive to suit a variety of applications
- The slotted design allows quick and easy assembly of conductor to HTAP using three Panduit 94V-0 cable ties. UL Listed and CSA Certified for applications up to 600V when crimped with Panduit and specified competitor crimping tools and Panduit crimping dies

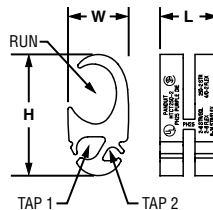

Part Number	Copper Conductor Size Range					Figure Dimensions In. (mm)			Panduit Die Color and Die No.	Wire Strip Length In. (mm)	Std. Pkg. Qty.
	Wire Strand Type	Run	Tap 1	Tap 2	Tap 3	L	W	H			
HTCT250-2-1	Code	250 kcmil – #2 AWG (120 – 35)	#2 – #6 AWG STR/SOL (25 – 16)	#8 – #14 AWG (6 – 2.5)	—	0.92 (23.4)	0.96 (24.4)	1.92 (48.8)	Purple PH25	1 (25)	1
	Flex	4/0 – #2 AWG (95 – 35)	#2 – #8 AWG (25 – 10)		—						



Clear Cover for HTCT HTAPs

- Made of high-impact plastic to provide high-impact strength and 360° inspections of crimped connection to assure the crimp is complete and the correct die was used
- Incorporate dual self-latching spring loaded latches and supplied with two Panduit UL 94V-0 cable ties to allow for easy snap-on assembly and ensure covers are secured
- Low profile design minimizes space requirements
- Each cover half supports installation information labels inside plastic retainer strips to allow labels to be viewed on either side of cover and to protect labels from being removed
- Incorporate molded in flash barriers which encompass the HTAP installation providing protection against electrical flash over
- UL 94V-0 flame rating and oxygen index of 28 providing self-extinguishing, flame retardant properties
- Part number, voltage rating, temperature rating and HTCT part number molded into cover for easy identification
- Flexible fingers located at each end of cover prevent foreign objects from entering cover and are made from ductile plastic material that allows easy installation and will not damage conductor insulation

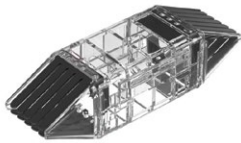

Part Number	Use with HTAP Part Number	Figure Dimensions			Std. Pkg. Qty.
		L	W	H	
CLRCVR2-1	HTCT2-2-1	5.10	1.66	1.40	1

Labels for clear covers are sold separately and are printed with the Panduit® PanTher™ LS8E Hand-Held Thermal Transfer Printer, see www.panduit.com for more information



Code/Flex Conductor HTAP Kits

Type HTWC

- The HTWC HTAP Kits have a two-piece high impact plastic clear cover to provide 360° inspection of crimped connection
- The cover has a UL 94V-0 flame rating and oxygen index of 28, providing self-extinguishing, flame retardant properties
- For use with code or flexible strand class G, H, I, and Diesel Locomotive Flex cable. Color-coded and marked with Panduit die index numbers for proper die selection
- UL listed and CSA certified for use up to 600V when crimped with Panduit and specified competitor crimping tools and Panduit crimping dies



HTWC250-2

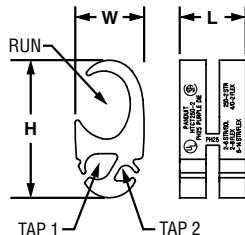

Part Number	Components		Wire Strand Type	Copper Conductor Size Range AWG (mm ²)				Std. Pkg. Qty.
	HTAP Part No.	Clear Cover Part No.		Run	Tap 1	Tap 2	Tap 3	
BEST SELLER HTWC250-2-1	HTCT250-2-1	CLRCVR3-1	Code	250 kcmil – #2 AWG (120 – 35)	#2 – #6 AWG STR/SOL (25 – 16)	#8 – #14 AWG (6 – 2.5)	—	1
			Flex	4/0 – #2 AWG (95 – 35)	#2 – #8 AWG (25 – 10)		—	
HTWC2-2-1	HTCT2-2-1	CLRCVR2-1	Code	#2 – #6 AWG STR/SOL (25 – 16)	#2 – #6 AWG STR/SOL (25 – 16)	#8 – #14 AWG (6 – 2.5)	#8 – #14 AWG (6 – 2.5)	1
			Flex	#2 – #8 AWG (25 – 10)	#2 – #8 AWG (25 – 10)	#8 – #14 AWG (6 – 2.5)	#8 – #14 AWG (6 – 2.5)	

www.panduit.com



E-Style Grounding Connectors

Type GCE

- The E-Style Grounding Connector is designed to enhance the crimp process using technology that meets the IEEE Std 837 - 2002 and REV 2014
- With wide range-taking ability and multi-conductor design provides flexibility with a minimum number of parts
- The slotted design allows quick and easy assembly while the pre-applied conductive antioxidant compound ensures a high quality mechanical and electrical bond and the UL 467 Listed and CSA 22.2
- Complies with vibration tests per MIL-STD-202G (METHOD 201A)
- Not rated for use with galvanized ground rods and/or galvanized cable

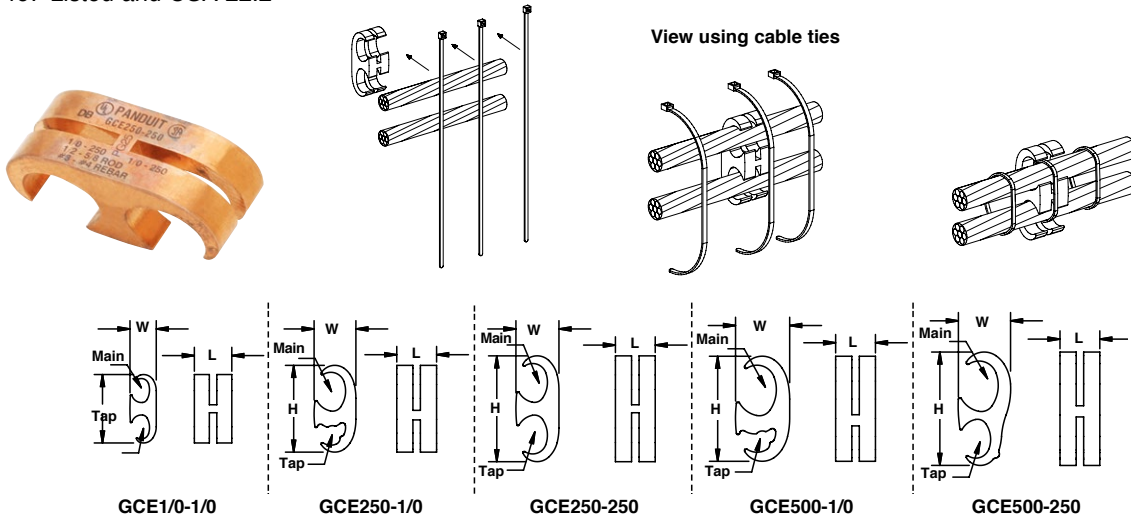

Part Number	Element	Copper Conductor Size Range AWG (mm ²)	Ground Rod Size In. (mm)	Rebar Size In. (mm)	Figure Dimensions In. (mm)			Panduit Color Code	Panduit Part and Die Index No.	Std. Pkg. Qty.
					L	W	H			
BEST SELLER GCE1/0-1/0	Main Tap	#6 SOL – 1/0 STR (16 – 50)	—	—	0.94 (23.9)	0.66 (16.8)	1.72 (43.7)	Red	CD-930G-1/0 PG10	1
BEST SELLER GCE250-1/0	Main Tap	1/0 STR – 250 kcmil (70 – 120) #6 SOL – 1/0 STR (16 – 50)	0.5 – 0.625 (12.7 – 15.9)	0.375 – 0.5, #3 – #4 (9.5 – 12.7), (#10 – #13)	1.00 (25.4)	1.05 (26.7)	2.18 (55.4)	Black	CD-930G-250 PG25	
BEST SELLER GCE250-250	Main Tap	1/0 STR – 250 kcmil (70 – 120)	0.5 – 0.625 (12.7 – 15.9)	0.375 – 0.5, #3 – #4 (9.5 – 12.7), (#10 – #13)	1.00 (25.4)	1.08 (27.4)	2.66 (67.6)			
BEST SELLER GCE500-1/0	Main Tap	250 – 500 kcmil (150 – 240) #6 SOL – 1/0 STR (16 – 50)	0.5 – 0.75 (12.7 – 19.1)	0.625 – 0.75, #5 – #6 (15.9 – 19.1), (#16 – #19)	1.00 (25.4)	1.36 (34.5)	2.64 (67.1)	Blue	CD-930G-500 PG50	
BEST SELLER GCE500-250	Main Tap	250 – 500 kcmil (150 – 240) 1/0 STR – 250 kcmil (70 – 120)	0.5 – 0.75 (12.7 – 19.1)	0.625 – 0.75, #5 – #6 (15.9 – 19.1), (#16 – #19)	1.00 (25.4)	1.32 (33.4)	2.85 (72.4)			



Figure 6 Style Grounding and Power Connectors

For Use with Stranded and Solid Copper Conductors

Type FIG6

- Wide range-taking ability and multi-conductor design provide flexibility with a minimum number of parts allowing conductor to conductor and conductor to ground rod and rebar applications
- Made from heavy wall, extruded, high conductivity copper provides high strength and premium electrical properties
- Pre-applied conductive antioxidant compound ensures a high quality mechanical and electrical bond, speeding installation
- For use with copper clad, solid copper and stainless steel ground rod types
- Marked with Panduit die index numbers for proper crimp die selection
- UL 467 Listed for grounding and bonding suitable for direct burial in earth and concrete when crimped with select Panduit and specified competitor crimp tools and crimp dies
- UL 486A-486B Listed for wire to wire power applications up to 35kV and temperature rated 90C with select Panduit and specified competitor crimp tools and crimp dies



Part Number	Main Copper Conductor Range AWG (mm ²)	Main Ground Rod Size In. (mm)	Main Rebar Size In. (mm ²)	Tap Copper Conductor Range AWG (mm ²)	Figure	Figure Dimensions In. (mm)				Panduit Color Code and Die Index No.	Std. Pkg. Qty.
						Length	Width	Height	Tap I.D.		
FIG6-500-2/0	STR: 25 – 500 kcmil (150 – 240)	0.625 – 0.75 (15.9 – 19.1)	0.625 – 0.75 #5 – #6 (#16M – #19M)	STR: 1/0 – 2/0	FIG. 5	0.75 (19.1)	1.37 (34.8)	2.60 (66.1)	0.33 (8.3)	Blue PG50	1
STR: 3/0 – 250 kcmil (95-120)				FIG. 5	0.75 (19.1)	1.37 (34.8)	2.60 (66.1)	0.62 (15.7)			
STR: 250 – 500 kcmil (150-240)				FIG. 6	1.00 (25.4)	1.38 (35.1)	2.82 (71.7)	0.85 (21.6)			

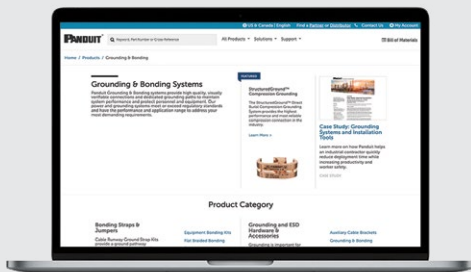

Like what you see? Want more?

Visit www.panduit.com for the full offering of Panduit products

www.panduit.com



Grounding Cross Connectors

Type GCC

- Only a single die required to crimp each element, which speeds installation and reduces costs
- Wide range-taking ability and multi-conductor design provide flexibility with a minimum number of parts, allowing for conductor to conductor, conductor to rebar, and conductor to ground rod applications
- Designed for the enhanced crimp process using patent pending technology meets IEEE Std 837 - 2002 and REV 2014
- Slotted design allows quick and easy assembly of conductor to connector using Panduit cable ties, included
- Pre-applied conductive antioxidant compound ensures a high quality mechanical and electrical bond, speeding installation
- Color-coded and marked with Panduit die index numbers for proper crimp die selection
- UL 467 Listed and CSA 22.2 Certified for grounding and bonding suitable for direct burial in earth or concrete when crimped with Panduit and specified competitor crimping tools and Panduit dies
- Complies with vibration tests per MIL-STD-202G (METHOD 201A)
- Not rated for use with galvanized ground rods and/or galvanized cable

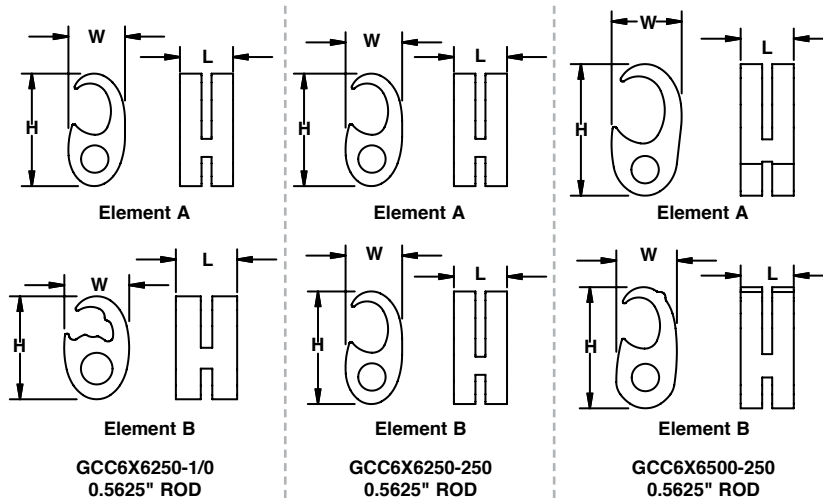

Part Number	Element	Copper Conductor Size Range AWG (mm ²)	Ground Rod Size In. (mm)	Rebar Size In. (mm)	Figure Dimensions In. (mm)			Panduit Color Code	Panduit Part and Die Index No.	Std. Pkg. Qty.
					L	W	H			
GCC6X6250-1/0	A	#2 SOL – 250 kcmil (35 – 120)	0.5 – 0.625 (12.7 – 15.9)	0.375 – 0.5, #3 – #4 (9.5 – 12.7), (#10 – #13)	1.00 (25.4)	1.06 (26.9)	2.12 (53.8)	Black	CD-930G-250 PG25	1
	B	#6 SOL – 1/0 STR (16 – 50)	—	—	1.00 (25.4)	1.06 (26.9)	1.68 (42.7)			
GCC6X6250-250	A	#2 SOL – 250 kcmil (35 – 120)	0.5 – 0.625 (12.7 – 15.9)	0.375 – 0.5, #3 – #4 (9.5 – 12.7), (#10 – #13)	1.00 (25.4)	1.06 (26.9)	2.66 (67.6)	Blue	CD-930G-500 PG50	
	B	#2 SOL – 250 kcmil (35 – 120)	—	—	1.00 (25.4)	1.06 (26.9)	2.66 (67.6)			
GCC6X6500-250	A	250 – 500 kcmil (150 – 240)	0.5 – 0.75 (12.7 – 19.1)	0.625 – 0.75, #5 – #6 (15.9 – 19.1), (#16 – #19)	1.00 (25.4)	1.32 (33.5)	2.48 (63.0)	Blue	CD-930G-500 PG50	
	B	#2 SOL – 250 kcmil (35 – 120)	—	—	1.00 (25.4)	1.16 (29.5)	2.29 (58.2)			



Figure 6 Cross Connect-Style Grounding and Power Connector

For Use with Stranded and Solid Copper Conductors
Type GCC6

- Wide range-taking ability and multi-conductor design provide flexibility with a minimum number of parts allowing conductor to conductor and conductor to ground rod and rebar applications
- Made from heavy wall, extruded, high conductivity copper provides high strength and premium electrical properties
- Pre-applied conductive antioxidant compound ensures a high quality mechanical and electrical bond, speeding installation
- For use with copper clad, solid copper and stainless steel ground rod types
- Marked with Panduit die index numbers for proper crimp die selection
- UL 467 Listed for grounding and bonding suitable for direct burial in earth and concrete when crimped with select Panduit and specified competitor crimp tools and crimp dies
- UL 486A-486B Listed for wire to wire power applications up to 35kV and temperature rated 90C with select Panduit and specified competitor crimp tools and crimp dies

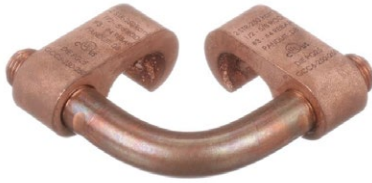

Part Number	Main Copper Conductor Range AWG (mm ²)	Main Ground Rod Size In. (mm)	Main Rebar Size In. (mm ²)	Tap Copper Conductor Range AWG (mm ²)	Figure Dimensions In. (mm)				Main Panduit Color Code and Die Index No.	Tap Panduit Color Code and Die Index No.	Std. Pkg. Qty.	
					Element Figure	Length	Width	Height				Conn. Rod O.D.
GCC6-2-2	Solid: 6 – 2 STR: 6 – 2 (16 – 25)	NA	NA	Solid: 6 – 2 STR: 6 – 2 (16 – 25)	Main Tap FIG. 1	0.75 (19.1)	0.62 (15.7)	1.40 (35.6)	0.375 (9.53)	Red PG10	Red PG10	1

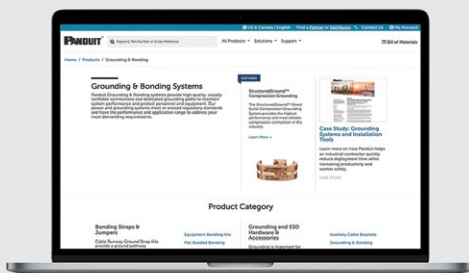

Like what you see? Want more?

Visit www.panduit.com for the full offering of Panduit products

www.panduit.com



Figure 8 Cross Connect-Style Grounding Connector

For Use with Solid Copper Conductors
Type GCC8

- Wide range-taking ability and multi-conductor design provide flexibility with a minimum number of parts allowing conductor to ground rod applications
- Made from heavy wall, extruded, high conductivity copper provides high strength and premium electrical properties
- Pre-applied conductive antioxidant compound ensures a high quality mechanical and electrical bond, speeding installation
- For use with copper clad and stainless steel ground rod types
- Marked with Panduit die index numbers for proper crimp die selection
- UL 467 Listed for grounding and bonding suitable for direct burial in earth and concrete when crimped with select Panduit and specified competitor crimp tools and crimp dies
- Add "TP" to suffix of the part numbers listed below for tin plated versions of connectors which are suitable for with galvanized steel ground rods

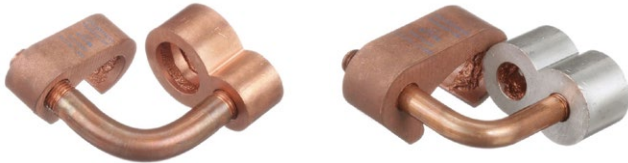

Tin Plated

Part Number	Copper Conductor Range AWG (mm ²)	Ground Rod Size In. (mm)	Figure Dimensions In. (mm)				Conn. Rod O.D.	Main Panduit Color Code and Die Index No.	Tap Panduit Color Code and Die Index No.	Std. Pkg. Qty.				
			Element Figure	Length	Width	Height								
GCC8-1/2-250	STR: 2 – 250 kcmil (35 – 120)	0.5 (12.7)	6, FIG. 1	0.75 (19.1)	0.91 (23.2)	2.10 (53.3)	0.375 (9.53)	Black PG25	Black PG25	1				
			8, FIG. 3	0.89 (22.5)	1.09 (27.7)	1.95 (49.25)								
GCC8-5/8-250		0.625 (15.9)	6, FIG. 1	0.75 (19.1)	0.91 (23.2)	2.10 (53.3)	0.375 (9.53)							
			8, FIG. 3	0.89 (22.5)	1.09 (27.7)	1.95 (49.25)								
GCC8-3/4-250		0.75 (19.1)	6, FIG. 1	0.75 (19.1)	0.91 (23.2)	2.10 (53.3)	0.56 (14.29)							
			8, FIG. 4	0.89 (22.5)	1.34 (34)	2.19 (55.50)								
GCC8-1-250		1 (25.4)	6, FIG. 1	0.75 (19.1)	0.91 (23.2)	2.10 (53.3)	0.56 (14.29)							
			8, FIG. 5	0.89 (22.5)	1.60 (40.70)	2.44 (62)								
GCC8-1/2-500		STR: 250 – 500 kcmil (150 – 240)	0.5 (12.7)	6, FIG. 2	0.75 (19.1)	1.37 (34.8)	2.60 (66.1)				0.375 (9.53)	Blue PG50	Black P106	1
				8, FIG. 3	0.89 (22.5)	1.09 (27.7)	1.95 (49.25)							
GCC8-5/8-500	0.625 (15.9)		6, FIG. 2	0.75 (19.1)	1.37 (34.8)	2.60 (66.1)	0.375 (9.53)							
			8, FIG. 3	0.89 (22.5)	1.09 (27.7)	1.95 (49.25)								
GCC8-3/4-500	0.75 (19.1)		6, FIG. 2	0.75 (19.1)	1.37 (34.8)	2.60 (66.1)	0.56 (14.29)							
			8, FIG. 4	0.89 (22.5)	1.34 (34)	2.19 (55.50)								
GCC8-1-500	1 (25.4)		6, FIG. 2	0.75 (19.1)	1.37 (34.8)	2.60 (66.1)	0.56 (14.29)							
			8, FIG. 5	0.89 (22.5)	1.60 (40.70)	2.44 (62)								



C-Style Grounding and Power Connector

For Use with Stranded and Solid Copper Conductors

Type CTAPR

- Wide range-taking ability and multi-conductor design provide flexibility with a minimum number of parts allowing conductor to conductor and conductor to round rod applications
- Made from heavy wall, extruded, high conductivity copper provides high strength and premium electrical properties
- Pre-applied conductive antioxidant compound ensures a high quality mechanical and electrical bond, speeding installation
- Marked with Panduit die index numbers for proper crimp die selection
- UL 467 Listed for grounding and bonding suitable for direct burial in earth and concrete when crimped with select Panduit and specified competitor crimp tools and crimp dies
- UL 486A-486B Listed for wire to wire power applications up to 35kV and temperature rated 90C with select Panduit and specified competitor crimp tools and crimp dies



Part Number	Element	Copper Conductor Range AWG (mm ²)	Ground Rod Size In. (mm)	Figure Dimensions In. (mm)			Panduit Die Index Code	Std. Pkg. Qty.
				Length	Width	Height		
CTAPR2-2-X	Main	6 STR – 2 STR 6 SOL – 1 SOL (16 – 25 STR) (16 – 35 SOL)	0.25 (6.4) Copper	0.75 (19.1)	0.56 (14.2)	1.16 (29.5)	PC	10
	Tap		NA					
CTAPR2/0-2-X	Main	1 STR – 2/0 STR (50)	0.375 (9.0) Copper Clad	0.75 (19.1)	0.72 (18.2)	1.43 (36.3)	PO	
	Tap	6 STR – 2 STR 6 SOL – 1 SOL (16 – 25 STR) (16 – 35 SOL)	NA					
CTAPR2/0-2/0-X	Main	1 STR – 2/0 STR (50)	0.375 (9.0) Copper Clad	0.75 (19.1)	0.74 (18.8)	1.55 (39.4)	PG25	
	Tap	NA						
CTAPR250-2/0-6	Main	3/0 STR – 250 kcmil (95 – 120)	0.5 – 0.625 (12.8 – 14.2) Copper Clad	0.75 (19.1)	0.93 (23.6)	1.98 (50.3)	PG25	
	Tap	6 STR – 2/0 STR 6 SOL – 3/0 SOL (16 – 50) (16 SOL – 70 SOL)	NA					
CTAPR250-250-6	Main	3/0 STR – 250 kcmil (95 – 120)	0.5 – 0.625 (12.8 – 14.2) Copper Clad	0.75 (19.1)	0.94 (23.9)	2.07 (52.6)	PG25	
	Tap	NA						
CTAPR500-2/0-6	Main	300 kcmil – 500 kcmil (185 – 240)	0.75 (17.2) Copper Clad	0.88 (22.4)	1.23 (31.2)	2.42 (61.5)	P500	6
	Tap	6 STR – 2/0 STR 6 SOL – 3/0 SOL (16 – 50) (16 SOL – 70 SOL)	NA					
CTAPR500-250-6	Main	300 kcmil – 500 kcmil (185 – 240)	NA	0.88 (22.4)	1.34 (33.9)	2.69 (68.2)		
	Tap	3/0 STR – 250 kcmil (95 – 120)						
CTAPR500-500-6	Main	300 kcmil – 500 kcmil (185 – 240)	NA	1.10 (27.9)	1.36 (34.5)	2.92 (74.2)		
	Tap	300 kcmil – 500 kcmil (185 – 240)						

*CTAPR500-500 and CTAPR500-250 cannot be installed with a CT-2920, when installing CTAPR Connectors with the CT-920CH, use Blackfin tool only

**CTAPR500-500 cannot be installed with a CT-930CH or CT-930





Universal Beam Grounding Clamp

Type GUBC

- The GUBC500-6 Universal beam grounding clamp fits on a wide range of standard (angled) and wide flange (parallel) structural steel beams providing a mounting pad suitable for a two-hole compression lug
- Install quickly and easily with standard 0.25" key hex wrench tooling
- UL 467 Listed and CSA 22.2 Certified for grounding and bonding suitable for direct burial in earth or concrete
- Comply with vibration tests per MIL-STD-202G (METHOD 201A)



GUBC500-6

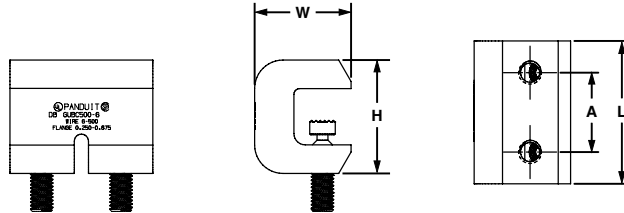

Part Number	Material	Copper Conductor Size Range AWG (mm ²)	Flange Thickness In. (mm)	Thread Size In.	Hex Size	Figure Dimensions In. (mm)				Std. Pkg. Qty.
						A	L	W	H	
BEST SELLER GUBC500-6	Copper	#6 AWG – 500 kcmil (16 – 240)	0.250 – 0.675 (6.3 – 17.1)	0.5 – 13	0.25	1.75 (44.4)	3.15 (80.0)	2.13 (54.0)	2.50 (63.5)	1



Code Conductor, Heavy Duty, CTAP

For Copper Code Connections

Type CTAP

- The Compression Connector Taps provides high-strength and premium electrical properties
- It is suitable for use with solid and stranded copper Code conductors for tapping into unbroken continuous main, as a wire joint or two-way splice
- The wide wire range-taking capability minimizes inventory requirements
- UL listed and CSA certified to 600V and temperature rated 90°C when crimped with Panduit and specified competitor crimping tools and dies

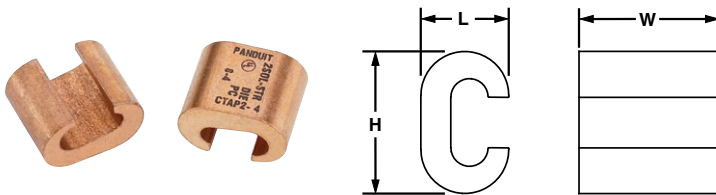

Part Number	Copper Conductor Size		Figure Dimensions In. (mm)			Panduit Die Index No.‡	Burndy Die Index No.‡	Wire Strip Length In. (mm)	Std. Pkg. Qty.
	AWG Run (mm ²)	AWG Tap (mm ²)	L	T	V				
BEST SELLER CTAP2/0-2-X	1/0 – 2/0 AWG STR	#8 – #2 AWG SOL or STR	0.80 (20.3)	0.93 (23.6)	1.32 (8.1)	PO	O	1 1/16 (27)	10
BEST SELLER CTAP4/0-2-X	3/0 – 4/0 AWG STR	#6 – #2 AWG SOL or STR	0.94 (23.9)	1.08 (27.4)	1.66 (42.2)	PD3	F	1.25 (32)	
CTAP4/0-4/0-X		3/0 – 4/0 AWG STR			1.00 (25.4)				

**Consult cable manufacturer for voltage stress relief instructions with applications greater than 2000V.

‡Visit www.panduit.com for tool and die information.

^Note: CTAP parts are UL Listed and CSA Certified with AWG wire only.

Not UL/CSA approved for use with metric wire. See GCE & GCC series parts for UL/CSA approved connections for metric wire.



Code Conductor, Thin Wall, CTAP

For Copper Code Stranded Connections Type CTAPF

- For copper-to-copper tapping, splicing or pigtailing
- Wide wire range-taking capability minimizes inventory requirements
- Color-coded for proper crimp die selection
- Ribbed design provides high strength
- Made from high conductivity wrought copper
- UL Listed and CSA Certified to 600 V and temperature rated to 90°C when crimped with Panduit and specified competitor crimping tools and dies[^]

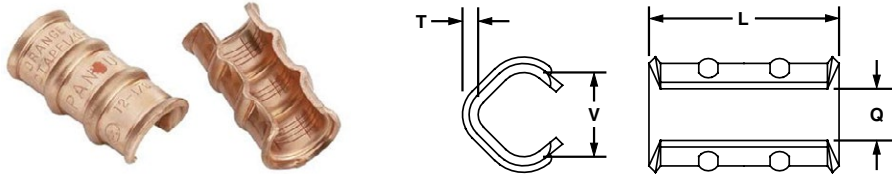

Part Number	Copper Conductor Size		Number of Ribs	Figure Dimensions In. (mm)				Panduit Color Code	Wire Strip Length In. (mm)	Std. Pkg. Qty.
	AWG Run (mm ²)	AWG Tap (mm ²)		L	T	V	Q			
CTAPF2-12-C [‡]	#4 AWG (25)	#4 AWG (25)	1	1.25 (31.8)	0.08 (2.0)	0.51 (13.0)	0.33 (8.4)	Pink	1.3125 (33.3)	100
	#3 AWG (25)	#5 AWG (16)								
	#2 AWG (25)	#12 – #6 AWG (4 – 16)								
CTAPF1/0-12-L	#2 AWG (35)	#4 – #2 AWG (25 – 35)	2	1.82 (46.2)	0.09 (2.3)	0.63 (16.0)	0.42 (10.7)	Orange	1.875 (47.6)	50
	#1 AWG (35)	#4 – #3 AWG (25)								
	1/0 AWG (50)	#12 – #4 AWG (4 – 25)								

[^]Note: CTAPF parts are UL Listed and CSA Certified with AWG wire only.
[‡]CSA Certified for grounding and bonding.
 Not Direct Burial Rated.



Bronze Service Post Connector, Male Stud, Single Conductor

- For grounding one copper code conductor to steel structures, busbars, or transformers or for tapping from busbar with hex nut and washer
- Made from high copper content, hard drawn copper rod provides high strength
- Pressure bar provides secure connection on a full range of conductor combinations used with each connector providing premium wire pull-out strength
- cULus 467 Listed for grounding and bonding and suitable for direct burial in earth or concrete

Type SP1 – Premium Grade

- True hex design for body and nut hex provides correct fit with socket, box, or open end wrenches for easy installation process
- Offered with standard and long stud lengths for optimized fit of the threaded stud through the mounting surface

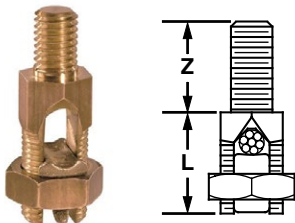

Part Number	Conductor Size Range (AWG)	Stud Size (UNC Threads)	Figure Dimensions (In.)		Nut Hex (In.)	Body Hex (In.)	Std. Pkg. Qty.
			L	Z			
SP1-4L-C	#10 SOL – #4 STR	0.3125 - 18	0.94	1.00	0.75	0.56	100

www.panduit.com



Bronze Service Post Connector, Male Stud, Single Conductor

- For grounding two copper code conductors to steel structures, busbars, or transformers or for tapping from busbar with hex nut and washer
- Made from high copper content, hard drawn copper rod provides high strength

- Pressure bar provides secure connection on a full range of conductor combinations used with each connector providing premium wire pull-out strength
- cULus 467 Listed for grounding and bonding and suitable for direct burial in earth or concrete

Type SP2 — Premium Grade

- True hex design for body and nut hex provides correct fit with socket, box, or open end wrenches for easy installation process

- Offered with standard and long stud lengths for optimized fit of the threaded stud through the mounting surface

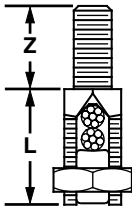

Part Number	Conductor Size Range (AWG)	Stud Size (UNC Threads)	Figure Dimensions (In.)		Nut Hex (In.)	Body Hex (In.)	Std. Pkg. Qty.
			L	Z			
SP2-2-C	#10 STR – #2 STR	0.375 – 16	1.38	0.63	0.88	0.69	100
SP2-2L-C			1.28	1.13			
SP2-2/0-Q	#2 SOL – 2/0 STR	0.5 – 13	1.88	0.75	1.13	0.88	25
SP2-2/0L-Q				1.25			
SP2-4/0-Q	#1 SOL – 4/0 STR	0.625 – 11	2.25	1.00	1.38	1.13	



Service Post Connector, Female Thread, Two Conductor, Bronze

- The SPF2-4-C Service Post Grounding Connector is designed for grounding two copper code conductors to steel structures, busbars, transformers
- The true hex design for body and nut hex provides correct fit with socket, box, or open-end wrenches, resulting in proper torquing of electrical connection

- The pressure bar provides a secure connection on a full range of conductor combinations used with each connector providing a premium wire pull-out strength
- cULus 467 Listed for grounding and bonding and suitable for direct burial in earth or concrete

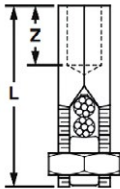

BEST SELLER

Part Number	Conductor Size Range	Thread Size*	Figure Dimensions In. (mm)		Nut Hex (In.)	Body Hex (In.)	Std. Pkg. Qty.
			L	Z			
SPF2-4-C	#10 SOL – #4 STR	0.3125 – 18	1.56 (39.6)	0.31 (7.9)	0.75	0.56	100

*UNC threads.



Grounding Clamp, U-Bolt, Bronze

Type GPL

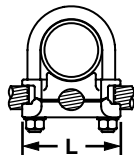
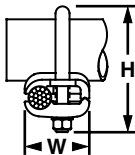

- The U-Bolt Bronze Grounding Clamps are used to ground copper conductor parallel or at a right angle to a rod, tube or pipe
- Wire range is 2/0 Sol.-250 kcmil
- cULus 467 Listed for grounding and bonding and suitable for direct burial in earth or concrete

Part Number	Ground Rod Size (In.)	Iron Pipe Size (In.)	Conductor Size Range	Figure Dimensions In. (mm)			Bolt Dia. (In.)	Hex Size (In.)	Std. Pkg. Qty.
				L	W	H			
GPL-6-Q	0.625 or 0.75	0.375	2/0 SOL – 250 kcmil	2.00 (50.8)	1.88 (47.8)	2.75 (69.9)	0.375	0.5625	25



Bronze Grounding Clamp with Spacer for Flat Surfaces

- Used to ground copper code conductor to flat surfaces
- Cast from high strength, electrolytic bronze to provide reliable grounding connections
- High strength silicone bronze hardware for long term reliable assembly

- Accommodates a wide range of conductor sizes – minimizes inventory requirement, saves cost
- Incorporates spacer plate to separate conductor from mounting surface
- cULus 467 Listed for grounding and bonding and suitable for direct burial in earth or concrete

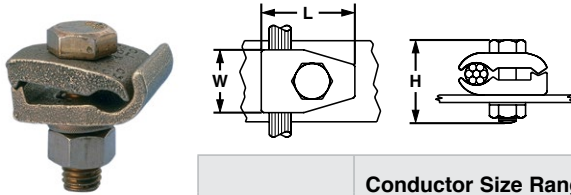

Part Number	Conductor Size Range (AWG)	Figure Dimensions (In.)			Hex Size (In.)		Std. Pkg. Qty.
		L	W	H	Bolt	Nut	
GM-3-Q	2/0 SOL – 250 kcmil	2.13 (54)	1.50 (38)	2.00 (51)	0.75	0.75	25
GM-3E-X	4 SOL – 300 kcmil	1.96 (50)		2.32 (59)			10



Grounding Mechanical Lugs

For Use with Stranded and Solid Copper Conductors
Type LCG

- Made from heavy wall, extruded, high conductivity copper provides high strength and premium electrical properties
- Compact design saves space
- Inspection window to visually assure full conductor insertion

- cULus Listed for grounding and bonding suitable for direct burial in earth and concrete
- UL Listed for use up to 600V and temperature rated 90°C
- Flat bottom allows for complete contact with mounting surface



Part Number	Conductor Range	Stud Size	Figure Dimensions In. (mm)				Installation Tool	Std. Pkg. Qty.
			W	H	T	L		
LCG8-C	#14 SOL – #8 STR AWG	#10	.38 (9.65)	.42 (10.66)	.08 (2.03)	.81 (20.57)	Slotted Screwdriver	100
LCG4-C	#14 SOL – #4 STR AWG	0.25	.54 (13.71)	.55 (13.97)	.09 (2.28)	1.11 (28.19)		



Aluminum One-Hole Grounding Lay-In Lug

- Used for quick installation of a continuous grounding conductor
- UL 467 Listed for grounding and bonding, copper lugs
UL Listed for direct burial in earth or concrete

- UL Listed for use up to 600V and temperature rated 90°C
- Wide wire range-taking capability minimizes inventory requirements



Tin-Plated Aluminum Body

Part Number	Set Screw Material	Conductor Size Range	Stud Hole Size (In.)	Hex Key Size (In.)	Length (In.)	Width (In.)	Height (In.)	Std. Pkg. Qty.
LIAS250-56-Q*	Zinc Plated Steel	#6 AWG – 250 kcmil	0.33	0.25	2.20	0.80	1.70	25

*Not DB Rated.

The use of Panduit oxide inhibiting joint compound (CMP) is recommended for pad to conductor connections. Refer to www.panduit.com for more information.

VeriSafe™ Absence of Voltage Testers Safer. Smarter. More Efficient.

Tired of voltage detectors? VeriSafe AVTs test for absence of voltage with the push of a button. VeriSafe AVTs meet the NFPA 70E and CSA-Z462 best practice for testing for absence of voltage, enabling your facility to operate safer, smarter, and more efficiently.

By automating this process, the VeriSafe™ Absence of Voltage Tester:

- Reduces the risk of exposure of electrical hazards for improved worker safety
- Reduces testing procedure time and complexity to improve productivity
- Supports compliance when used to verify the electrical lockout/tagout process as described in NFPA 70E

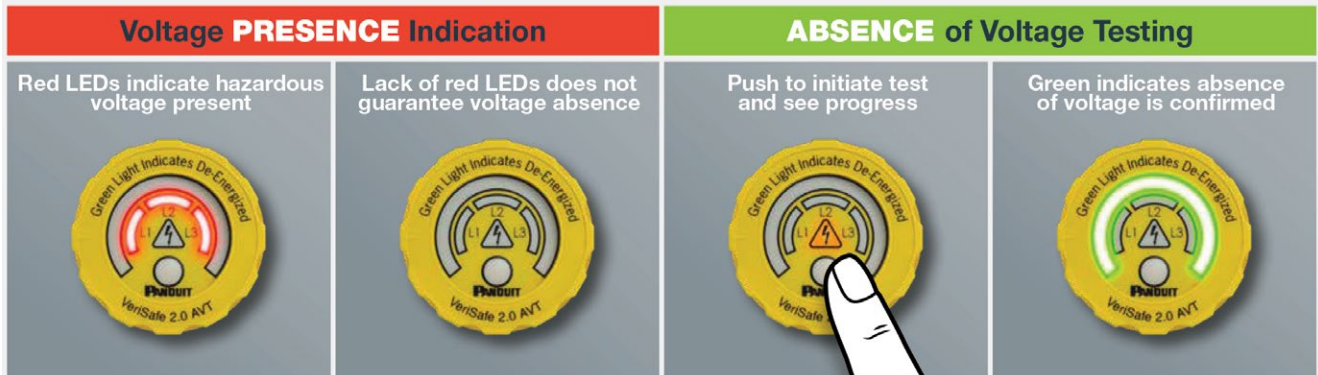

Part Number	For Use In	Description
VeriSafe 2.0 Absence of Voltage Testers		
VS2-AVT-3PB-02	3-Phase AC Systems, up to 1000 V	Includes three-phase battery powered indicator module, 2 ft. (0.6m) system cable, and 10 ft. (3.0m) sensor leads
VS2-AVT-3PB-08		Includes three-phase battery powered indicator module, 8 ft. (2.4m) system cable, and 10 ft. (3.0m) sensor leads
VS2-AVT-3PB-16		Includes three-phase battery powered indicator module, 16 ft. (4.8m) system cable, and 10 ft. (3.0m) sensor leads
VS2-AVT-3PF-02		Includes three-phase battery free indicator module, 2 ft. (0.6m) system cable, and 10 ft. (3.0m) sensor leads
VS2-AVT-3PF-08		Includes three-phase battery free indicator module, 8 ft. (2.4m) system cable, and 10 ft. (3.0m) sensor leads
VS2-AVT-3PF-16		Includes three-phase battery free indicator module, 16 ft. (4.8m) system cable, and 10 ft. (3.0m) sensor leads
VS2-AVT-1PB-02	1-Phase AC or DC Systems, up to 1000 V	Includes single-phase/DC battery powered indicator module, 2 ft. (0.6m) system cable, and 10 ft. (3.0m) sensor leads
VS2-AVT-1PB-08		Includes single-phase/DC battery powered indicator module, 8 ft. (2.4m) system cable, and 10 ft. (3.0m) sensor leads
VS2-AVT-1PB-16		Includes single-phase/DC battery powered indicator module, 16 ft. (4.8m) system cable, and 10 ft. (3.0m) sensor leads
VS2-AVT-1PF-02		Includes single-phase/DC battery free indicator module, 2 ft. (0.6m) system cable, and 10 ft. (3.0m) sensor leads
VS2-AVT-1PF-08		Includes single-phase/DC battery free indicator module, 8 ft. (2.4m) system cable, and 10 ft. (3.0m) sensor leads
VS2-AVT-1PF-16		Includes single-phase/DC battery free indicator module, 16 ft. (4.8m) system cable, and 10 ft. (3.0m) sensor leads
VeriSafe 1.0 Absence of Voltage Testers		
VS-AVT-C02-L03	3-Phase AC Systems, up to 600 V	Includes three-phase battery powered indicator module, 2 ft. (0.6m) system cable, and 3 ft. (0.9m) sensor leads
VS-AVT-C08-L10		Includes three-phase battery powered indicator module, 8 ft. (2.4m) system cable, and 10 ft. (3.0m) sensor leads



Battery Free Single-Phase Indicator



Battery Powered 3-Phase Indicator

VeriSafe 2.0 Network Module

The VeriSafe Network Module provides a way to leverage data from a 2.0 Absence of Voltage Tester (AVT) for smarter system monitoring. Take troubleshooting to the next level by automatically measuring voltage and monitoring AVT results, without the need to open equipment doors and covers.



Key Features and Benefits

Smart Technology

- Keep doors and covers closed for monitoring and troubleshooting
- View AVT test results and data logs
- Use voltage and test data to trigger alerts in your control system

Flexible Integration

- Ethernet connectivity
- Solid state I/O contacts
- Custom Add on Profile for easy integration in Rockwell Automation Studio 5000, Automatic Diagnostics ready

Part Number	Description
VS2-NET	Network Module accessory, for use with VS2-AVT models

VeriSafe™ Insulation Piercing Connectors



BEST SELLER

- The VeriSafe™ Insulation Piercing Connector provides a fast, secure, and reliable way to terminate AVT sensor leads.
- The compact connector design accommodates up to two taps in a single housing that fully insulates both connections.
- The connector allows taps to be made without compromising the integrity of conductors and includes integrated strain relief.
- Ideal for new and retrofit applications, connections can be made without modifying existing conductor runs.

Part Number	Description
VS-CKP14-6	Insulation Piercing Connection Kit for tapping 14 to 6 AWG conductors. Rated for 600 V installations. Kit includes 3 connectors for installation of 1 AVT
VS-CKP4-000	Insulation Piercing Connection Kit for tapping 4 to 3/0 AWG conductors. Rated for 600 V installations. Kit includes 3 connectors for installation of 1 AVT
VS-CKP1K4/0-500	Insulation Piercing Connection Kit for tapping AWG 4/0 to 500MCM copper conductors. Rated for 1KV installations. Kit includes 3 connectors for installation of 1 AVT

Additional connection options and cable accessories can be found on www.panduit.com/verisafe.

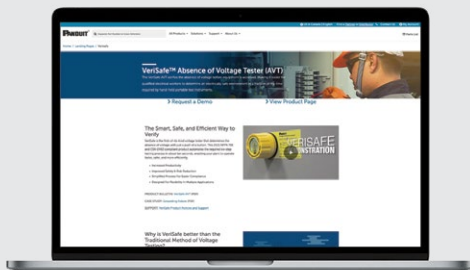

**Like what you see?
Want more?**

Visit www.panduit.com/verisafe for the full offering of Panduit products

www.panduit.com

Electrical Labels in Dispenser



- Indoor/outdoor rated
- Laminated label material protects legend from abrasion and chemicals
- Resistant to UV light, chemical atmosphere and abrasion
- Excellent life and adhesion properties

Part Number	Description	Diameter
PLD-57	300 labels/dispenser	0.75"

Order number of pieces required, in multiples of Standard Package Quantity.

Self-Laminating Safety Tag Carriers



- Cut out paper to fit and insert into the self-laminating carrier allows tags to be resistant to mild chemicals and acids. Sturdy brass grommet provides extra durability
- Panduit PLT2S (7.40 inches) nylon ties included for quick and easy installation
- Meet OSHA Standard 1910.147 for lockout tag 50 lb. pull force requirement

Part Number	Lamination Style	Tag Size	Pkg. Qty.
PST-1	Front only	3.00" x 2.00"	10

Self-Laminating Fiber Optic Cable Marker Tags

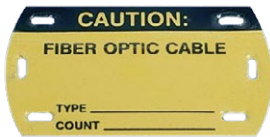

- Rigid vinyl, self-laminating material
- Indoor/outdoor rated; high quality, rugged material resistant to abrasion; legend is protected by overlaminates; use where adhesives will not work
- Temperature range: 0°F to 176°F (-18°C to 80°C)

Part Number	Legend	Color (Legend/Background)	Width		Height		Tags per Pkg.	Std. Pkg. Qty.	Std. Ctn. Qty.
			In.	mm	In.	mm			
PST-FO	CAUTION: FIBER OPTIC CABLE TYPE _____ COUNT _____	Black/Yellow	3.50	89.0	2.00	51.0	5	1	40
PST-FOBLNK	BLANK	Yellow							

Order number of packages required in multiples of Standard Package Quantity.

BEST SELLER

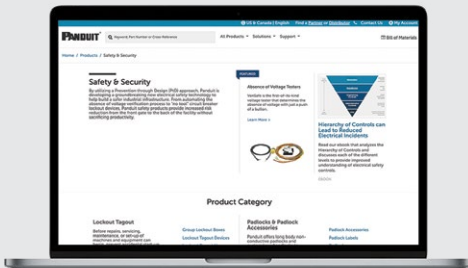

**Like what you see?
Want more?**

Visit www.panduit.com for the full offering of Panduit products

www.panduit.com

PowerLOK™ Circuit Breaker Lockout Devices

PowerLOK™ Circuit Breaker Lockout Devices include many innovative features to provide a versatile, easy to use lockout/tagout device. These devices can be applied to single or multi-pole circuit breakers (such as 120/277 V breakers) to prevent the breaker from being turned back on; for safe performance of maintenance or service in accordance with lockout/tagout procedures.



- Two metal contacts
- Fits single and multi-pole circuit breakers
- Two-position padlock design
- Two-piece construction

Part Number	Description	Std. Pkg. Qty.
PSL-PCBNT	PowerLOK™ “No Tool circuit” breaker lockout	1

Universal & I-LINE™ Circuit Breaker Lockout Devices

- Quickly locks out circuit breakers (such as 120/277 V breakers); ideal for industrial and harsh applications
- PSL-CB can be installed using a screwdriver
- PSL-CBNT and PSL-CBILNT can be installed by hand, with no tool required



PSL-CBNT



PSL-CBILNT

Part Number	Description	Std. Pkg. Qty.
PSL-CB	Universal circuit breaker lockout	1
PSL-CBNT	“No Tool” Universal circuit breaker lockout	5
PSL-CBNT-V	“No Tool” Universal circuit breaker lockout	5
PSL-CBILNT	“No Tool” circuit breaker lockout for use with Square D I-LINE™/Federal Pacific (FPE) circuit breakers	1

BEST SELLER

Miniature Circuit Breaker Lockout Devices

- Quickly locks out miniature circuit breakers commonly used in industrial automation and motor control
- On the PSL-MCBNT, multiple padlock orientations allow adjacent circuit breakers to be locked out individually
- PSL-MCBNT can be installed by hand with no tool required



Part Number	Description	Std. Pkg. Qty.
PSL-MCBNT	“No Tool” miniature circuit breaker lockout	1
PSL-MCBNT-V	“No Tool” miniature circuit breaker lockout	5

Large Handle Circuit Breaker Lockout Device

- Quickly locks out large molded-case circuit breakers (such as 480/600 V breakers)
- Can be installed by hand, with no tool required



Part Number	Description	Std. Pkg. Qty.
PSL-CBL	Large handle circuit breaker lockout	1

Lockout Hasps

These devices provide the ideal solution when procedures require multiple workers on locked-out equipment.

Workers can be assigned a padlock (sold separately) with shackle diameter up to 9/32" to attach to the hasp before starting their task. Ensure the energy source stays locked out – with multiple workers' padlocks in the holes of the closed hasp. Once each worker completes their task, they remove their padlock. The hasp cannot be removed until the last padlock is removed.

- Energy sources can be locked out quickly for more than one worker for group lockout applications
- Heavy duty hasps with tamper-resistant designs to deter vandalism
- Variety of lockout hasp styles and sizes to accommodate a wide range of lockout applications



PSL-MLD



PSL-1



PSL-1A

Part Number	Description	Max. No. Locks	Std. Pkg. Qty.	Std. Ctn. Qty.
PSL-MLD	Multiple lockout device; includes lockout hasp and 6.0' (1.8m) vinyl coated galvanized steel cable with loophole	6	1	20
PSL-MLDH-X	Multiple lockout device (hasp only)		10	—
PSL-1	Hasp with 1.00" (25.40mm) diameter jaw and overlapping tabs	12	12	144
PSL-1A	Hasp with 1.00" (25.40mm) diameter jaw			

BEST SELLER

Toggle Switch Cover Device

- Compact secure design fits most toggle switches and some small circuit breakers
- Easily attached without removal of faceplate or screws
- Accommodates switches
 - 0.45 – 0.78 inches tall
 - 0.25 – 0.38 inches wide
 - 0.25 – 0.40 inches thick
- Constructed of rugged nylon and stainless steel providing strength, durability, added security and corrosion resistance



Part Number	U.O.M.
PSL-WS	Each

Corded AC Plug Cover Lockout Device

- Insert plugs, close cover, and secure with padlock and tag (sold separately)
- Individual corded plugs in a wide range of sizes can be locked out to prevent energization
- Constructed of rugged polypropylene providing strength, durability, and added security



Part Number	Description	Std. Pkg. Qty.	Std. Ctn. Qty.
PSL-CL480	Lockout fits 240 – 480 VAC corded plug, 3.25" x 3.25" x 6.50" inside dimensions	12	144

Metal Group Lock Box

- Manage multiple employees and energy sources involved in a group lockout procedure
- Accommodates up to 13 padlocks (not included)
- Available in industrial powder-coated or stainless steel construction
- Dimensions:
 - 9.00"W x 6.00"H x 3.25"D



Part Number	Description	U.O.M.
PSL-GLBN	Group Lock Box	Each

Electrician Lockout Kit



Part Number	Kit Contents	Std. Pkg. Qty.
PSL-PK-EA	(1) Screwdriver (1) PSL-8 padlock (1) PSL-MLD multiple lockout (1) PSL-WS wall switch lockout (1) PSL-CBNT "No Tool" circuit breaker lockout (1) PSL-P plug lockout (5) PVT-30 blocking tags (1) PSL-PK pouch	1

Contractor Lockout Kit



Part Number	Kit Contents	Std. Pkg. Qty.
PSL-KT-CONA	(1) Screwdriver (6) PSL-8 padlocks (1) PSL-1A hasp (1) PSL-MLD lockout (3) PSL-WS wall switch lockout (3) PSL-CBNT "No Tool" circuit breaker lockout (3) PSL-P plug lockouts (1) carrying case – 5.0" x 3.5" x 11.0" (15 Tags) PVT-98 "EQUIPMENT LOCKED OUT BY..." safety tags	1

Non-Conductive Safety Padlocks

Aluminum body and shackle with non-conductive vinyl cover delivers protection against electrical hazards for maximum safety, specifically in lockout/tagout applications. Padlock is available with the standard 1.77-inch body or 3-inch long body design that allows safety message to be displayed on the padlocks in two languages



BEST SELLER

Part Number	Color	Body Height	Std. Pkg. Qty.
PSL-8BL	Black	1.77" (45.2mm)	1
PSL-8BU	Blue		
PSL-8GR	Green		
PSL-8OR	Orange		
PSL-8	Red		
PSL-8YL	Yellow		
PSL-8PU	Purple		

P Underground Hazard Tape

- Polyethylene (HTU, HTD) materials
- Temperature range: -30°F to 200°F (-34°C to 93°C)
- Detectible Laminated Aluminum (HTDU) materials temper
- Temperature range: -30°F to 220°F (-34°C to 104°C)
- Pre-Printed
- Indoor/outdoor rated
- Designed for direct burial
- Highly visible legend is protected from abrasion and chemicals
- Resistant to UV light, chemical atmosphere, and abrasion
- Will not biodegrade



Part Number	Legend	Color (Legend/ Background)	Height		Length		Std. Pkg. Qty.
			In.	mm	In.	mm	
HTDU6R-E	CAUTION ELECTRIC LINE BURIED BELOW	Black/Red	6.00	152.00	1000.00	305.00	1

Pan-Steel® Self-Locking Cable Ties – MLT Series

- The Panduit Pan-Steel® stainless steel cable tie speeds up installation with a patented, wide entry self-locking head that eases band threading and insertion
- Unique locking ramp design and strengthening ribs allows the tie to lock into place at any length along the tie body with increased lock strength
- Fully rounded edges ensure worker and bundle safety



Part Number	Max Bundle Diameter		Length*		Min Loop Tensile Strength**		Min Bundle Diameter		Width		Thickness		Recommended Installation Tool***	Std. Pkg. Qty.	Std. Ctn. Qty.
	In.	mm	In.	mm	lbs	N	In.	mm	In.	mm	In.	mm			

AISI 304 Stainless Steel – For General Purpose

Standard Cross Section

BEST SELLER MLT1S-CP	1.0	25	5.0	127	200	890	0.50	12.7	0.18	4.6	0.010	0.25	GS4MT-E, HTMT, PPTMT, ST2MT	100	500
BEST SELLER MLT2S-CP	2.0	51	7.9	201											
BEST SELLER MLT2.7S-CP	2.7	69	10.2	259											
BEST SELLER MLT4S-CP	4.0	102	14.3	362											
BEST SELLER MLT6S-CP	6.0	152	20.5	521											
BEST SELLER MLT8S-CP	8.0	203	26.8	679											

Light-Heavy Cross Section

MLT4LH-LP	4.0	102	14.3	362	250	1112	0.50	12.7	0.25	6.4	0.010	0.25	GS4MT-E, HTMT, PPTMT, ST2MT	50	250
-----------	-----	-----	------	-----	-----	------	------	------	------	-----	-------	------	-----------------------------------	----	-----

Heavy Cross Section

MLT2H-LP	2.0	51	7.9	201	450	200	0.50	12.7	0.31	7.9	0.010	0.25	GS4MT-E, ST2MT, HTMT, PPTMT, PBTMT	50	250
MLT2.7H-LP	2.7	69	10.2	259									GS4MT-E, ST2MT, HTMT, PPTMT		
BEST SELLER MLT4H-LP	4.0	102	14.3	362									GS4MT-E, ST2MT, HTMT, PPTMT, PBTMT		
BEST SELLER MLT6H-LP	6.0	152	20.5	521											
MLT8H-LP	8.0	203	26.8	679											
MLT10H-LP	10.0	254	33.0	838											

AISI 316 Stainless Steel – For Most Corrosive Environments

Standard Cross Section

BEST SELLER MLT1S-CP316	1.0	25	5.0	127	200	890	0.50	12.7	0.18	4.6	0.010	0.25	GS4MT-E, HTMT, PPTMT, ST2MT	100	500
BEST SELLER MLT2S-CP316	2.0	51	7.9	201											
BEST SELLER MLT4S-CP316	4.0	102	14.3	362											
MLT6S-CP316	6.0	152	20.5	521											

Heavy Cross Section

BEST SELLER MLT2H-LP316	2.0	51	7.9	201	450	2000	0.50	12.7	0.31	7.9	0.010	0.25	GS4MT-E, HTMT, PBTMT, PPTMT, ST2MT	50	250
MLT4H-LP316	4.0	102	14.3	362											
MLT6H-LP316	6.0	152	20.5	521											
MLT8H-LP316	8.0	203	26.8	679											

Super-Heavy Cross Section

MLT4SH-LP316	4.0	102	17.1	434	900	4005	1.00	25.4	0.63	15.9	0.015	0.38	RT2HT, RT2HTN, PBTMT	50	250
MLT6SH-LP316	6.0	152	23.4	594											

*For other lengths, thicknesses and material grades available, contact Panduit Customer Service or refer to www.panduit.com.

**Per SAE Standard AS23190/3 (formerly MIL).

Panduit Pan-Steel® Stainless Tie - MLTFC Series

- The Panduit Pan-Steel® self-locking cable tie speeds up installation with a unique self-locking head design that locks into place at any part of the tie body
- The 316 stainless steel is wrapped in UV-resistant, halogen-free, Polyester to promote worker safety and reliability in corrosive, high-vibration, temperature-extreme environments
- The Polyester coating is available in six color options and provides visual indication for easy identification in color-coding applications



Part Number	Max Bundle Diameter		Length*		Color	Min Loop Tensile Strength**		Width		Thickness^		Recommended Installation Tool***	Std. Pkg. Qty.	Std. Ctn. Qty.
	In.	mm	In.	mm		lbs	N	In.	mm	In.	mm			
Standard Cross Section^^														
MLTFC2S-CP316	2.0	51	7.9	201	Black	100	445	0.18	4.6	0.010	0.25	GS4MT-E, ST2MT, HTMT, PPTMT	100	500
MLTFC4S-CP316	4.0	102	14.3	362										
Heavy Cross Section^^														
MLTFC2H-LP316	2.0	51	7.9	201	Black	250	1112	0.31	7.9	0.010	0.25	GS4MT-E, ST2MT, HTMT, PPTMT, PBTMT	50	250
MLTFC4H-LP316	4.0	102	14.3	362										
MLTFC6H-LP316	6.0	152	20.5	521										
MLTFC8H-LP316	8.0	203	26.8	679										
Extra-Heavy Cross Section^^^														
MLTFC4EH-LP316	4.0	102	17.1	434	Black	300	1335	0.50	12.7	0.010	0.25	ST2MT, RT2HT, RT2HTN, PBTMT	50	250
Super-Heavy Cross Section^^^														
MLTFC4SH-LP316	4.0	102	17.1	434	Black	300	1335	0.50	12.7	0.010	0.25	RT2HT, RT2HTN, PBTMT	50	250

*Other lengths available, contact Panduit Customer Service.
 ^Base material less coating. ^^Minimum bundle diameter is 0.50" (12.7mm).

Pan-Steel® Stainless Tie - MLTC Series

- The Panduit Pan-Steel® self-locking cable tie speeds up installation with a unique self-locking head design that locks into any part of the tie body
- The Nylon 11 coating provides additional edge protection and prevents corrosion between dissimilar metals
- The 316 stainless steel is wrapped in UV-resistant, halogen-free, low-smoke Nylon to promote worker safety and reliability in corrosive environments



Part Number	Max Bundle Diameter		Length*		Min Loop Tensile Strength**		Min Bundle Diameter		Width		Thickness^		Recommended Installation Tool***	Std. Pkg. Qty.	Std. Ctn. Qty.
	In.	mm	In.	mm	lbs	N	In.	mm	In.	mm	In.	mm			
AISI 316 Stainless Steel – For Nylon 11 Selectively Coated Cable Ties															
Heavy Cross Section															
MLTC2H-LP316	2.0	51	7.9	201	250	1112	0.50	12.7	0.31	7.9	0.010	0.25	GS4MT-E, ST2MT, HTMT, PPTMT, PBTMT	50	250
MLTC4H-LP316	4.0	102	14.3	362											
MLTC6H-LP316	6.0	152	20.5	521											
MLTC8H-LP316	8.0	203	26.8	679											
MLTC10H-LP316	10.0	254	33.0	838											

*Other lengths available, contact Panduit Customer Service.
 ^Base material less coating.

PCS Custom-Length Cushion Sleeve

- The cushion sleeving is compatible with heavy or super-heavy cross section ties, custom length banding systems, or MS strapping, for use in harsh environments and application
- Can be used indoors or outdoors (excellent ultraviolet resistance, good resistance to petroleum, and many chemicals)



Part Number	Material	Used with Pan-Steel® Ties/Strapping	Width		Length		Std. Pkg. Qty. (reels)‡
			In.	mm	Ft.	m	
BEST SELLER PCSSH-B-CR*	Neoprene	MLT/EH/SH and MS Straps	0.91	23.1	100	30.5	1
BEST SELLER PCSLSH-B-CR	TPE	MLT/EH/SH and MS Straps	1.05	26.8			

*Meets MIL-R-6855

‡Order in number of reels required.

Pkg. -CR = 100 ft. (30.5m) reel.

Pan-Steel® Wave-Ty™

- Patented wave-form spring maintains greater installed tension on non-resilient objects
- Tightly clamps on applications where other stainless steel ties will not function
- Retains tension on a solid bundle with minimal applied force
- Guarantees performance in critical applications
- Self-locking with low thread force



Part Number	Max Bundle Diameter		Length*		Min Loop Tensile Strength**		Min Bundle Diameter		Width		Thickness		Recommended Installation Tool***	Std. Pkg. Qty.	Std. Ctn. Qty.
	In.	mm	In.	mm	lbs.	N	In.	mm	In.	mm	In.	mm			

AISI 304 Stainless Steel – For Superior Grip on Rigid Bundles Heavy Cross Section

MLT6WH-LP	6.0	152	20.5	521	450	2000	2.0	51	0.31	7.9	0.010	0.25	GS4MT-E, HTMT, PPTMT, ST2MT	50	250
-----------	-----	-----	------	-----	-----	------	-----	----	------	-----	-------	------	-----------------------------	----	-----

AISI 316 Stainless Steel – For Superior Grip on Rigid Bundles Heavy Cross Section

MLT4WH-TL316	4.0	102	14.3	362	450	2000	2.0	51	0.31	7.9	0.010	0.25	GS4MT-E, HTMT, PPTMT, ST2MT	250	2500
--------------	-----	-----	------	-----	-----	------	-----	----	------	-----	-------	------	-----------------------------	-----	------

*For other lengths, thicknesses and material grades available, contact Panduit Customer Service or refer to www.panduit.com.

**Per SAE Standard AS23190/3 (formerly MIL).

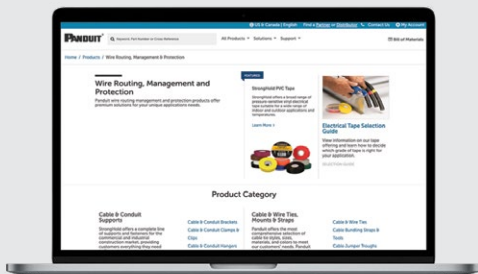

Like what you see? Want more?

Visit www.panduit.com for the full offering of Panduit products

www.panduit.com

Stainless Steel Tie Mounts

- Low profile
- One hole mounting

- For use with standard, light-heavy, and heavy cross section Pan-Steel® Ties as well as 0.38 inch (9.5mm) wide strapping
- 304 Stainless Steel

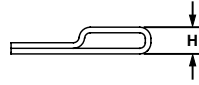
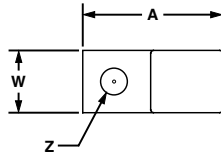

Part Number	Used with Pan-Steel® Ties/Strapping	Mounting Method*	Length A		Width W		Height H		Hole Diameter Z		Std. Pkg. Qty.	Std. Ctn. Qty.
			In.	mm	In.	mm	In.	mm	In.	mm		
MTM1H10-C	MLTS/LH/H, MLTC/H, MLTFC/S/H, or MSW38	#10 (5mm) screw	0.90	22.6	0.40	10.2	0.17	4.4	0.21	5.4	100	1000

*Stainless steel screws are recommended for fastening to avoid corrosion problems associated with dissimilar metals. Contact Customer Service for additional sizes and material grades available.

Stainless Steel Push Mount

- No tapping required
- Used where only one side of the panel is accessible
- Nothing to assemble

- For use with standard, light-heavy, and heavy cross section Pan-Steel® Ties
- 304 Stainless Steel

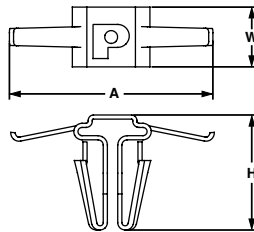

Part Number	Used with Pan-Steel® Ties/Strapping	Mounting Method	Length A		Width W		Height H		Panel Thickness		Std. Pkg. Qty.	Std. Ctn. Qty.
			In.	mm	In.	mm	In.	mm	In.	mm		
MPWM-H56-Q	MLTS/LH/H, MLTC/H, MLTFC/S/H	Inserted into pre-drilled hole 5/16" (8mm)	0.84	21.3	0.29	7.3	0.56	14.2	0.03 – 0.09	0.8 – 2.4	25	250

Stainless Steel 2-Way Tie Mount

- Allows stainless steel cable ties to be inserted from either of two sides
- Low profile

- Single hole center mounting for maximum holding and stability
- For use with standard, light-heavy, and heavy cross section Pan-Steel® Ties
- 304 Stainless Steel

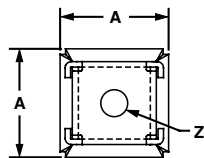

Part Number	Used with Pan-Steel® Ties/Strapping	Mounting Method*	Length A		Height H		Screw Head Height G		Slot Width Q		Hole Diameter Z		Std. Pkg. Qty.	Std. Ctn. Qty.
			In.	mm	In.	mm	lbs.	N	In.	mm	In.	mm		
MTM2H-Q	MLTS/LH/H, MLTC/H, MLTFC/S/H	#8 (4mm) screw	0.71	18.0	0.30	8.0	0.09	2.3	0.35	9.0	0.17	4.5	25	250

*Stainless steel screws are recommended for fastening to avoid corrosion problems associated with dissimilar metals.

Cable Tie Installation Tools



PBTMT

- Tools speed installation
- Feature high reliability, low maintenance, long life

- GS4MT-E and PBTMT feature automatic tension and cut-off capabilities for improved productivity and installer safety



GS4MT-E

BEST SELLER

BEST SELLER



ST2MT

Part Number	Description	Std. Pkg. Qty.
-------------	-------------	----------------

High Volume Use

PBTMT	Battery powered installation tool, for use with Pan-Steel® Heavy, Extra-Heavy, and Super-Heavy Cross Section MLT Style Ties, and MLTD Double Wrapped Style Ties, 2 – 12 volt lithium-ion batteries and 115 volt, 60 Hz charger included.	1
-------	--	---

Medium Volume Use

GS4MT-E	Used with standard, light-heavy, and heavy cross section Pan-Steel® type MLT ties, type MLTC/MLTFC coated ties, and type MLTDH double wrapped ties.	1
ST2MT	Used with standard, light-heavy, heavy and extra-heavy cross section Pan-Steel® type MLT ties, standard and heavy cross section MLTC/MLTFC ties or extra heavy MLTDH double wrapped ties.	

RT2HT Installation Tool



- Cable tie side entry for immediate positioning of tie and tool to speed installation
- Multi-position rear handle provides flexibility for a one or two hand installation

- Replacement cutter blade and handle available

Part Number	Part Description	Std. Pkg. Qty.
RT2HT	Used with extra-heavy, extra-heavy 15 and super-heavy cross section Pan-Steel® type MLT, Heat Trace Wave-Ty™ and MLTFC ties. Width of tool nose 2.60" (66.0mm).	1

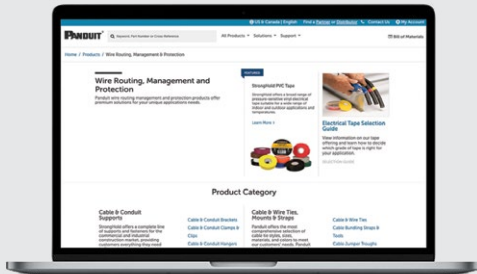

Like what you see? Want more?

Visit www.panduit.com for the full offering of Panduit products

www.panduit.com



Ring Terminal, Nylon Insulated

Type PN-R

- Ring tongue design assures a secure connection in high vibration applications
- The metal insulation grip sleeve crimps to wire insulation, providing protection and strain relief to the crimp joint for high vibration applications
- Internal barrel serrations assure good wire contact and maximum tensile strength
- UL Flammability UL 94 HB, maximum insulation temperature 221°F (105°C)
- UL and CSA rated up to 600V per UL 486A/B

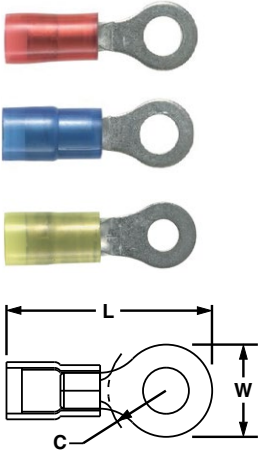

BEST SELLER

Part Number	Wire Range	Color Code	Stock Thickness (In.)	Max Ins. (In.)	Stud Size	Figure Dimensions (in)			Recommended Installation Tool	Std. Pkg. Qty.**	Std. Ctn. Qty.
						L	W	C			
PN18-6R-C	22 – 18 AWG	Red	0.03	0.145	#6	0.80	0.25	0.22	CT-100‡, CT-1550‡, CT-1551‡, CT-2300/ST‡, CT-2500/L‡, UP14ZLW‡	100	500
PN18-8R-C					#8	0.86					
PN18-10R-C					#10	0.88					
PN14-6R-C	18 – 14 AWG	Blue	0.03	0.162	#6		0.31	0.25	CT-100‡, CT-1550‡, CT-1551‡, CT-2300/ST‡, CT-2500/L‡, UP14ZLW‡	100	500
PN14-8R-C					#8	0.85					
PN14-10R-C					#10						
PN14-14R-C					1/4"	1.05	0.46	0.38			
PN10-8R-L	12 – 10 AWG	Yellow	0.04	0.225	#8		0.37	0.31	CT-100‡, CT-1550‡, CT-1551‡, CT-2300/ST‡, CT-2500/L‡, UP14ZLW‡	50	
PN10-10R-L					#10	1.06	0.38	0.31			
PN10-14R-L					1/4"	1.21	0.52	0.38			
PN10-38R-L					3/8"	1.29	0.58	0.43			

**Bulk and/or convenience packaging may be available, contact Panduit® Customer Service for additional information.

‡UL and CSA approved tooling/product combinations. For crimping tool information see www.panduit.com.

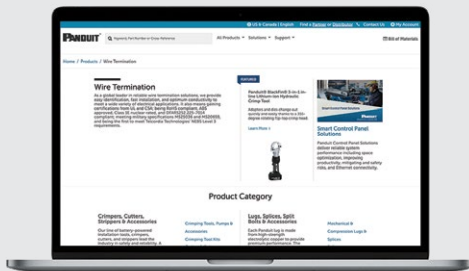

Like what you see? Want more?

Visit www.panduit.com for the full offering of Panduit products

www.panduit.com



Ring Terminal, Vinyl Insulated – Funnel Entry

Type PV-R

- Insulation support helps to prevent wire damage in bending applications
- Ring tongue design assures a secure connection in high vibration applications
- Brazed seam protects terminal barrel from splitting during the crimp process
- Internal barrel serrations assure good wire contact and maximum tensile strength
- UL Flammability UL 94V-0, maximum insulation temperature 221°F (105°C)
- UL and CSA rated up to 600 V per UL 486A/B

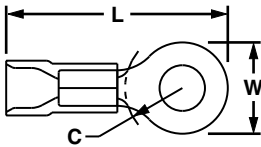

BEST SELLER

Part Number	Wire Range	Color Code	Stock Thickness (In.)	Max Ins. (In.)	Stud Size	Figure Dimensions (In.)			Recommended Installation Tool	Std. Pkg. Qty.**	Std. Ctn. Qty.
						L	W	C			
PV18-6R-CY	22 – 18 AWG	Red	0.03	0.150	#6	0.86	0.25	0.22	CT-100‡, CT-1550‡, CT-1551‡, CT-2300/ST‡, CT-2500/L‡, UP14ZLW‡	100	500
PV18-8R-CY					#8	0.91		0.26			
PV18-10R-CY					#10	0.94		0.27			
PV14-6R-C	16 – 14 AWG	Blue	0.03	0.170	#6		0.31		CT-100‡, CT-1550‡, CT-1551‡, CT-2300/ST‡, CT-2500/L‡, UP14ZLW‡	100	500
PV14-8R-C					#8	0.92		0.25			
PV14-10R-C					#10						
PV14-14R-C					1/4"	1.12	0.46	0.38			
PV10-8R-L	12 – 10 AWG	Yellow	0.04	0.225	#8	1.05	0.31	0.31	CT-100‡, CT-1550‡, CT-1551‡, CT-2300/ST‡, CT-2500/L‡, UP14ZLW‡	50	
PV10-10R-L					#10						
PV10-14R-L					1/4"	1.23	0.52	0.38			
PV10-56R-L					5/16"						
PV10-38R-L					3/8"	1.31	0.58	0.41			

**Bulk and/or convenience packaging may be available, contact Panduit® Customer Service for additional information.

‡UL and CSA approved tooling/product combinations. For crimping tool information see www.panduit.com.

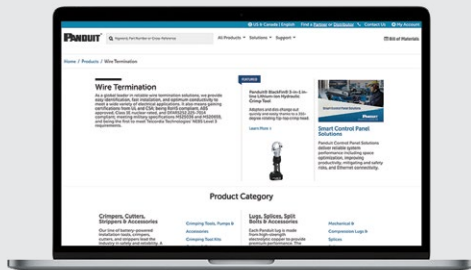

Like what you see? Want more?

Visit www.panduit.com for the full offering of Panduit products

www.panduit.com



Ring Terminal, Large Wire, Vinyl Insulated

Type PV-R

- Ring tongue design assures a secure connection in high vibration applications
- Insulation support helps to prevent wire damage in bending applications
- Brazed seam protects terminal barrel from splitting during the crimp process
- Internal barrel serrations assure good wire contact and maximum tensile strength
- UL Flammability UL 94V-0, maximum insulation temperature 221°F (105°C)
- UL rated up to 600V per UL 486A/B

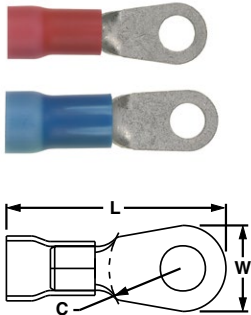

Part Number	Wire Range	Color Code	Stock Thickness (In.)	Max Ins. (In.)	Stud Size	Figure Dimensions (In.)			Recommended Installation Tool	Std. Pkg. Qty.**	Std. Ctn. Qty.
						L	W	C			
PV8-10R-QY	8 AWG	Red	0.04	0.280	#10	1.53	0.47	0.43	CT-720, CD-720PV8-2‡, CT-2600/L, CD-2600-PV8‡	25	250
PV8-14R-QY					1/4"						
PV6-14R-X	6 AWG	Blue	0.05	0.340	1/4"	1.65		0.48	CT-720, CD-720PV8-2‡, CT-2600/L, CD-2600-PV6‡	10	100

**Bulk packaging may be available, contact Panduit® Customer Service for additional information.
‡UL approved tooling/product combinations. For crimping tool information see www.panduit.com.



Ring Terminal, Large Wire, Vinyl Expanded Insulation

Type PV-RX

- Ring tongue design assures a secure connection in high vibration applications
- Expanded wire entry designed to accommodate wire with a larger insulation thickness
- Insulation support helps to prevent wire damage in bending applications
- Brazed seam protects terminal barrel from splitting during the crimp process
- Internal barrel serrations assure good wire contact and maximum tensile strength
- UL Flammability UL 94V-0, maximum insulation temperature 221°F (105°C)
- UL rated up to 600V per UL 486A/B

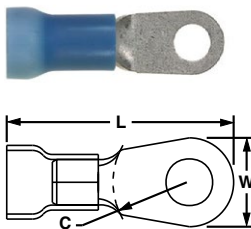

Part Number	Wire Range	Color Code	Stock Thickness (In.)	Max Ins. (In.)	Stud Size	Figure Dimensions (In.)			Recommended Installation Tool	Std. Pkg. Qty.**	Std. Ctn. Qty.
						L	W	C			
PV6-14RX-X	6 AWG	Blue	0.05	0.436	1/4"	1.61	0.47	0.51	CT-720, CD-720PV8-2‡, CT-2600/L, CD-2600-PV6‡	20	200

**Bulk packaging may be available, contact Panduit® Customer Service for additional information.
‡UL approved tooling/product combinations. For crimping tool information see www.panduit.com.



Ring Terminal, Non-Insulated

Type P-R

- Ring tongue design assures a secure connection in high vibration applications
- Internal barrel serrations assure good wire contact and maximum tensile strength
- Brazed seam protects terminal barrel from splitting during the crimp process
- Barrel of terminal internally beveled to provide quick and easy wire insertion
- Maximum recommended operating temperature 302°F (150°C)
- UL and CSA rated up to 2000V per UL 486A/B

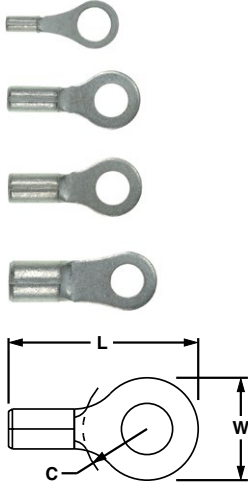

Part Number	Wire Range	Stock Thickness (In.)	Stud Size	Figure Dimensions (In.)			Recommended Installation Tool	Std. Pkg. Qty.**	Std. Ctn. Qty.
				L	W	C			
P14-10R-C	18 – 14 AWG	0.03	#10	0.71	0.31	0.25	CT-100‡, CT-200‡, CT-1570‡, CT-2300/ST‡, CT-2500/L‡, UP14ZLW‡	100	1000
P14-14R-C			1/4"	0.91	0.46	0.38			
P10-10R-L [^]	14 – 10 AWG	0.04	#10	0.81	0.38	0.31	CT-100‡, CT-200‡, CT-1570‡, CT-1701‡, CT-2300/ST‡, CT-2500/L‡, UP14ZLW‡	50	500
P10-14R-L			1/4"	0.96	0.52	0.38			

**Bulk packaging may be available, contact Panduit® Customer Service for additional information.
‡UL and CSA approved tooling/product combinations. For crimping tool information see www.panduit.com.



Ring Terminal, Non-Insulated – High Temperature

Type P-RHT

- Ring tongue design assures a secure connection in high vibration applications
- Nickel plated copper for temperatures up to 650°F (343°C)
- Internal barrel serrations assure good wire contact and maximum tensile strength
- Brazed seam protects terminal barrel from splitting during the crimp process
- Barrel of terminal internally beveled to provide quick and easy wire insertion
- Rated up to 2000V

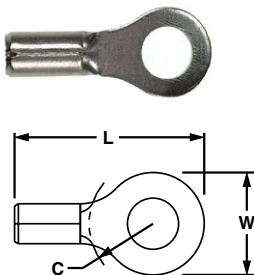

Part Number	Wire Range	Stock Thickness (In.)	Stud Size	Figure Dimensions (In.)			Recommended Installation Tool	Std. Pkg. Qty.**	Std. Ctn. Qty.
				L	W	C			
P10-10RHT6-L	12 – 10 AWG	0.04	#10	0.81	0.38	0.33	CT-100, CT-200, CT-1570, CT-1701, CT-2300/ST, CT-2500/L, UP14ZLW	50	500

**Bulk packaging may be available, contact Panduit® Customer Service for additional information.



Ring Terminal, Large Wire Non-Insulated

Type P-R

- Designed for use with #8 - #2 AWG copper wire
- Ring tongue design assures a secure connection in high vibration applications
- Internal barrel serrations assure good wire contact and maximum tensile strength
- Brazed seam protects terminal barrel from splitting during the crimp process
- Barrel of terminal internally beveled to provide quick and easy wire insertion
- Maximum recommended operating temperature 302°F (150°C)
- UL and CSA rated up to 2000V per UL 486A/B

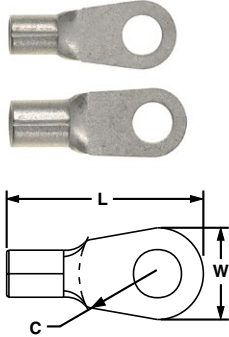

Part Number	Wire Range	Stock Thickness (In.)	Stud Size	Figure Dimensions (In.)			Recommended Installation Tool	Std. Pkg. Qty.**	Std. Ctn. Qty.
				L	W	C			
P8-14R-Q	8 AWG	0.04	1/4"	1.14	0.47	0.43	CD-2600-P8‡, CT-1701‡, CT-2600/L	25	250
P6-14R-E	6 AWG	0.05		1.21			CD-2600-P6‡, CT-1701‡, CT-2600/L		

**Bulk packaging may be available, contact Panduit Customer Service for additional information.
‡UL and CSA approved tooling/product combinations. For crimping tool information see www.panduit.com.



Fork Terminal, Nylon Insulated

Type PN-F

- Fork design provides for fast and easy installation, without the need to remove fastener
- Metal insulation grip sleeve crimps to wire insulation, providing protection to the crimp joint during high vibration applications
- Internal barrel serrations assure good wire contact and maximum tensile strength
- UL Flammability UL 94 HB, maximum insulation temperature 221°F (105°C)
- UL and CSA rated up to 600V per UL 486A/B

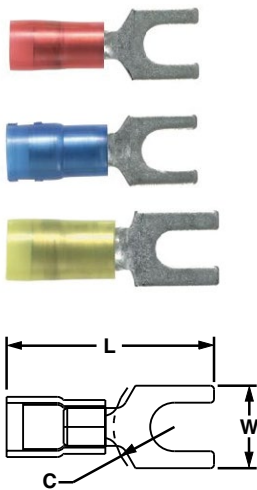

Part Number	Wire Range	Color Code	Stock Thickness (In.)	Max Ins. (In.)	Stud Size	Figure Dimensions (In.)			Recommended Installation Tool	Std. Pkg. Qty.**	Std. Ctn. Qty.
						L	W	C			
PN18-8F-C	22 – 18 AWG	Red	0.03	0.145	#8	0.85	0.32	0.23	CT-100‡, CT-1550‡, CT-1551‡, CT-2300/ST‡, CT-2500/L‡, UP14ZLW‡	100	500
PN14-6F-C	18 – 14 AWG	Blue				#6	0.79	0.28	0.19		
PN14-8F-C			#8	0.85	0.31	0.23	CT-100‡, CT-1550‡, CT-1551‡, CT-2300/ST‡, CT-2500/L‡, UP14ZLW‡				
PN14-10F-C			#10	0.87	0.34	0.24	CT-100‡, CT-1550‡, CT-1551‡, CT-2300/ST‡, CT-2500/L‡, UP14ZLW‡				
PN10-8F-L	12 – 10 AWG	Yellow	0.04	0.225	#8	1.03	0.37	0.22	CT-100‡, CT-1550‡, CT-1551‡, CT-2300/ST‡, CT-2500/L‡, UP14ZLW‡	50	
PN10-10F-L					#10	1.04	0.37	0.22	CT-100‡, CT-1550‡, CT-1551‡, CT-2300/ST‡, CT-2500/L‡, UP14ZLW‡		

**Bulk and/or convenience packaging may be available, contact Panduit® Customer Service for additional information.
‡UL Listed, cULus Listed, and CSA approved tooling/product combinations.
For crimping tool information see www.panduit.com.



Panduit Vinyl Insulated Fork Terminal

Type PV-F

- Fork design provides for fast and easy installation, without the need to remove fastener
- Brazed seam protects terminal barrel from splitting during the crimp process
- Internal barrel serrations assure good wire contact and maximum tensile strength.
- Barrel insulation provides protection and strain relief when crimped
- UL Flammability UL 94V-0, maximum insulation temperature 221°F (105°C)
- UL and CSA rated up to 600V per UL 486A/B

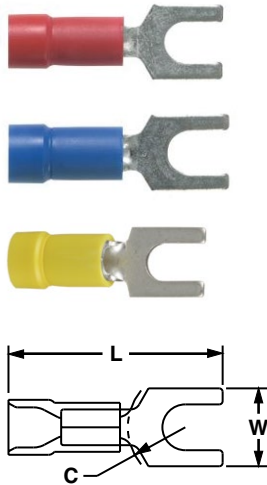

BEST SELLER

Part Number	Wire Range	Color Code	Stock Thickness (In.)	Max Ins. (In.)	Stud Size	Figure Dimensions (In.)			Recommended Installation Tool	Std. Pkg. Qty.**	Std. Ctn. Qty.
						L	W	C			
PV18-6F-CY	22 – 16 AWG	Red	0.03	0.150	#6	0.86	0.30	0.21	CT-100‡, CT-1550‡, CT-1551‡, CT-2300/ST‡, CT-2500/L‡, UP14ZLW‡	100	500
PV18-8F-CY					#8	0.93	0.25				
PV18-10F-CY					#10	0.35	0.25				
PV14-6F-C	16 – 14 AWG	Blue	0.03	0.170	#6	0.84	0.28	0.19	CT-100‡, CT-1550‡, CT-1551‡, CT-2300/ST‡, CT-2500/L‡, UP14ZLW‡	100	500
PV14-8F-C					#8	0.90	0.31	0.23			
PV14-10F-C					#10	0.92	0.34	0.24			
PV10-6F-L	14 – 10 AWG	Yellow	0.04	0.225	#6	1.01	0.31	0.25	CT-100‡, CT-1550‡, CT-1551‡, CT-2300/ST‡, CT-2500/L‡, UP14ZLW‡	50	500
PV10-8F-L					#8	1.04	0.37				
PV10-10F-L					#10	1.04	0.37				

**Bulk and/or convenience packaging may be available, contact Panduit® Customer Service for additional information.

‡UL Listed, cULus Listed, and CSA approved tooling/product combinations. For crimping tool information see www.panduit.com.



Locking Fork Terminal, Vinyl Insulated – Funnel Entry

Type PV-LF

- Locks in place for secure connection
- Fork design provides for fast and easy installation, without the need to remove fastener
- Insulation support helps to prevent wire damage in bending applications
- Internal barrel serrations assure good wire contact and maximum tensile strength
- UL Flammability UL 94V-0, maximum insulation temperature 221°F (105°C)
- UL and CSA rated up to 600V per UL 486A/B

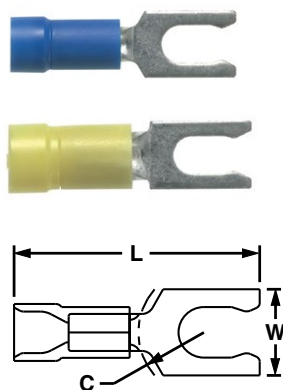

Part Number	Wire Range	Color Code	Stock Thickness (In.)	Max. Ins. (In.)	Stud Size	Figure Dimensions (In.)			Recommended Installation Tool	Std. Pkg. Qty.**	Std. Ctn. Qty.
						L	W	C			
PV14-6LF-C	18 – 14 AWG	Blue	0.03	0.170	#6	0.90	0.25	0.22	CT-100‡, CT-1550‡, CT-1551‡, CT-2300/ST‡, CT-2500/L‡, UP14ZLW‡	100	500
PV14-8LF-C					#8	0.97	0.29	0.25			
PV10-8LF-L	12 – 10 AWG	Yellow	0.04	0.225	#8	1.05	0.30	0.23	CT-100‡, CT-1550‡, CT-1551‡, CT-2300/ST‡, CT-2500/L‡, UP14ZLW‡	50	500
PV10-10LF-L					#10	1.04	0.34				

**Bulk and/or convenience packaging may be available, contact Panduit Customer Service for additional information. ‡UL and CSA approved tooling/product combinations. For crimping tool information see www.panduit.com.

www.panduit.com



Male/Female Coupler, Nylon Fully Insulated – Funnel Entry

Type DNF

- Disconnect can be inserted and removed from the male tab without the use of tools for lower installed cost
- Fully insulated design provides protection from electrical shorts
- Internal barrel serrations assure good wire contact and maximum tensile strength
- Internal wire stop assures proper length of insertion into terminal barrel, providing a higher quality connection
- Coupler, male, and female parts sold separately
- UL Flammability UL 94 HB, maximum insulation temperature 221°F (105°C)
- UL and CSA rated up to 600V per UL 310

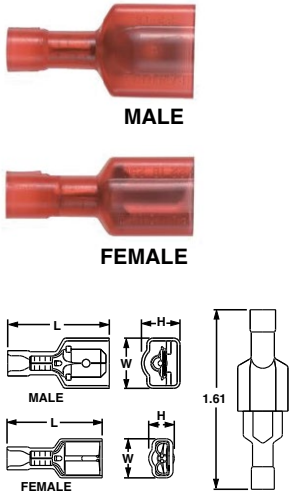

Part Number	Wire Range	Color Code	Max. Ins. (In.)	Figure Dimensions (In.)			Tab Size (in)	Recommended Installation Tool	Std. Pkg. Qty.**	Std. Ctn. Qty.
				L	W	C				
DNF18-250FIM-L Male	22 – 18 AWG	Red	0.133	0.90	0.42	0.27	0.250 x 0.032	CT-100‡, CT-1525‡, CT-2300/ST, CT-2500/L, UP14ZLW	50	250
DNF18-250FIB-C Female			0.136	0.84	0.35	0.22				
DNF14-250FIM-L Male	16 – 14 AWG	Blue	0.158	0.90	0.42	0.27		CT-1525‡, CT-2300/ST, CT-2500/L, UP14ZLW	50	250
DNF14-250FIB-C Female			0.160	0.84	0.35	0.22				

**Bulk packaging may be available, contact Panduit® Customer Service for additional information.
‡UL and CSA approved tooling/product combinations. For crimping tool information see www.panduit.com.



Female Disconnect, Nylon Fully Insulated – Funnel Entry

Type DNF-FIB

- Disconnect can be inserted and removed from the male tab without the use of tools for lower installed cost
- Fully insulated design provides protection from electrical shorts
- Internal wire stop assures proper length of insertion into terminal barrel, providing a higher quality connection
- UL Flammability UL 94 HB, maximum insulation temperature 221°F (105°C)
- UL and CSA rated up to 600V per UL 310

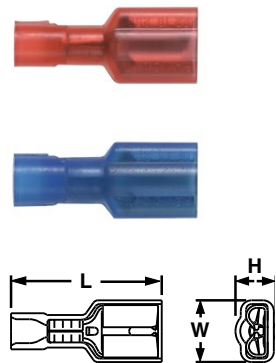

Part Number	Wire Range	Color Code	Max. Ins. (In.)	Figure Dimensions (In.)			Tab Size (In.)	Recommended Installation Tool	Std. Pkg. Qty.**	Std. Ctn. Qty.
				L	W	C				
DNF18-110FIB-C	22 – 18 AWG	Red	0.120	0.71	0.19	0.16	0.110 x 0.032	CT-100‡, CT-1525‡, CT-2300/ST, CT-2500/L, UP14ZLW	100	1000
DNF10-250FIB-L	12 – 10 AWG	Yellow	0.220	0.96	0.35	0.23	0.250 x 0.032	CT-1525‡, CT-2300/ST, CT-2500/L	50	500

**Bulk packaging may be available, contact Panduit® Customer Service for additional information.
‡UL and CSA approved tooling/product combinations. For crimping tool information see www.panduit.com.



Female Disconnect, Nylon Fully Insulated – Funnel Entry, Metal Collar

Type DNF-FI

- Disconnect can be inserted and removed from the male tab without the use of tools for lower installed cost
- Fully insulated design provides protection from electrical shorts
- Internal wire stop assures proper length of insertion into terminal barrel, providing a higher quality connection
- Barrel design with larger outside diameter for use with more common hand tools
- UL Flammability UL 94 HB, maximum insulation temperature 221°F (105°C)
- UL and CSA rated up to 600V per UL 310

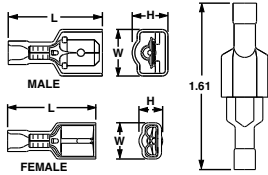

Part Number	Wire Range	Color Code	Max. Ins. (In.)	Figure Dimensions (In.)			Tab Size (In.)	Recommended Installation Tool	Std. Pkg. Qty.**	Std. Ctn. Qty.
				L	W	C				
DNF10-250FI-L	12 – 10 AWG	Yellow	0.220	0.95	0.36	0.27	0.250 x 0.032	CT-100‡, CT-1550‡, CT-1551‡, CT-2300/ST, CT-2500/L, UP14ZLW‡	50	500

**Bulk packaging may be available, contact Panduit Customer Service for additional information.
‡UL and CSA approved tooling/product combinations. For crimping tool information see www.panduit.com.



Female Disconnect, Nylon Barrel Insulated – Funnel Entry

Type DNF

- Disconnect can be inserted and removed from the male tab without the use of tools for lower installed cost
- Metal insulation grip sleeve crimps to wire insulation, providing protection to the crimp joint during high vibration applications
- Internal barrel serrations assure good wire contact and maximum tensile strength
- Internal wire stop assures proper length of insertion into terminal barrel, providing a higher quality connection
- UL Flammability UL 94 HB, maximum insulation temperature 194°F (90°C)
- UL and CSA rated up to 300V per UL 310

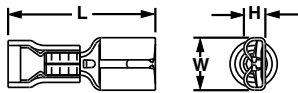

Part Number	Wire Range	Color Code	Max. Ins. (In.)	Figure Dimensions (In.)			Tab Size (In.)	Recommended Installation Tool	Std. Pkg. Qty.**	Std. Ctn. Qty.
				L	W	C				
DNF18-250-C	22 – 18 AWG	Red	0.138	0.81	0.29	0.12	0.250 x 0.032	CT-1550, CT-1551, CT-2300/ST, CT-2500/L, UP14ZLW‡	100	500
DNF14-250-C	16 – 14 AWG	Blue	0.162	0.83						

**Bulk packaging may be available, contact Panduit® Customer Service for additional information.
‡UL and CSA approved tooling/product combinations. For crimping tool information see www.panduit.com.



Female Disconnect, Vinyl Barrel Insulated

Type DV-B

- Disconnect can be inserted and removed from the male tab without the use of tools for lower installed cost
- Internal barrel serrations assure good wire contact and maximum tensile strength

- Internal wire stop assures proper length of insertion into terminal barrel, providing a higher quality connection
- UL Flammability UL 94V-0, maximum insulation temperature 221°F (105°C)
- UL and CSA rated up to 600V per UL 310

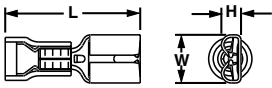

Part Number	Wire Range	Color Code	Max Ins. (In.)	Figure Dimensions (In.)			Tab Size (In.)	Recommended Installation Tool	Std. Pkg. Qty.**	Std. Ctn. Qty.
				L	W	C				
DV14-250B-C ▲	16 – 14 AWG	Blue	0.170	0.81	0.29	0.12	0.250 x 0.032	CT-1525 [^] , CT-2300/ST, CT-2500/L	100	500
DV10-250-L* ▲	12 – 10 AWG	Yellow	0.229	1.03	0.30	0.13		CT-1550 [^] , CT-1551 [^] , CT-2300/ST, CT-2500/L, UP14ZLW	50	

*Sleeved barrel, maximum insulation temperature 194°F (90°C).

**Bulk packaging may be available, contact Panduit Customer Service for additional information.

‡UL and CSA approved tooling/product combinations. For crimping tool information see www.panduit.com.

[^]CSA approved tooling/product combinations.

▲UL Recognized only.



Right Angle Female Disconnect, Nylon Insulated – Funnel Entry

Type DNFR-B

- Right angle design for use in limited space applications
- Disconnect can be inserted and removed from the male tab without the use of tools for lower installed cost
- Longer barrel design for use with Panduit® standard disconnect tool

- UL Flammability UL 94 HB, maximum insulation temperature 221°F (105°C)
- UL and CSA rated up to 600V per UL 310

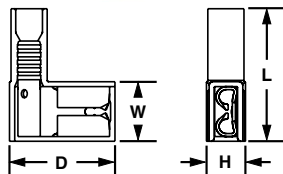

Part Number	Wire Range	Color Code	Max Ins. (In.)	Figure Dimensions (In.)				Tab Size (In.)	Recommended Installation Tool	Std. Pkg. Qty.	Std. Ctn. Qty.
				L	W	H	D				
DNFR14-250B-L	16 – 14 AWG	Blue	0.155	0.78	0.36	0.20	0.63	0.250 x 0.032	CT-1525‡, CT-2300/ST, CT-2500/L	50	500

**Bulk packaging may be available, contact Panduit® Customer Service for additional information.

‡UL and CSA approved tooling/product combinations. For crimping tool information see www.panduit.com.

UL LISTED Pin Terminal, Vinyl Insulated – Funnel Entry

Type PV-P

- Solid pin designed to prevent damage to the wire from over tightening, resulting in a reliable electrical connection
- Insulation support helps to prevent wire damage in bending applications
- Brazed seam protects terminal barrel from splitting during the crimp process
- Internal barrel serrations assure good wire contact and maximum tensile strength
- For use with pin-type terminal blocks
- UL Flammability UL 94V-0, maximum insulation temperature 221°F (105°C)
- UL rated up to 600V per UL 486A/B

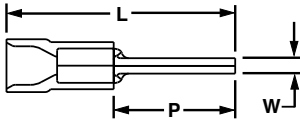

Part Number	Wire Range	Color Code	Max Ins. (In.)	Figure Dimensions (In.)			Recommended Installation Tool	Std. Pkg. Qty.**	Std. Ctn. Qty.
				L	W	P			
PV18-P47-CY	22 – 18 AWG	Red	0.150	0.97	0.07	0.49	CT-100, CT-260, CT-1550, CT-1551, CT-2300/ST, CT-2500/L	100	1000
PV14-P47-C	16 – 14 AWG	Blue	0.170						

**Bulk packaging may be available, contact Panduit® Customer Service for additional information.

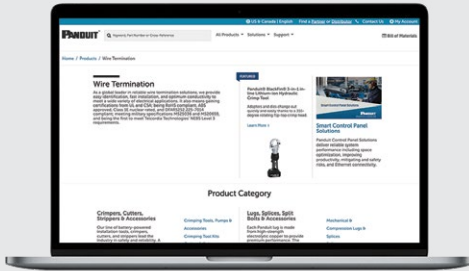

**Like what you see?
Want more?**

Visit www.panduit.com for the full offering of Panduit products



Butt Splice, Nylon Insulated

Type BSN

- Designed to splice two solid or stranded wires together to repair or lengthen wires
- Butted configuration provides low profile for limited space applications
- Brazed seam protects terminal barrel from splitting during the crimp process
- Internal wire stop assures proper length of insertion into terminal barrel
- UL Flammability UL 94 HB, maximum insulation temperature 221°F (105°C)
- UL and CSA rated up to 600V per UL 486C



BEST SELLER

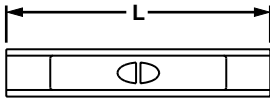

Part Number	Wire Range	Color Code	Max Ins. (In.)	Figure Dimensions (In.)		Recommended Installation Tool	Std. Pkg. Qty.**	Std. Ctn. Qty.
				L				
BSN22-C*	26 – 22 AWG	Yellow	0.080	0.79		CT-1525, CT-2300/ST, CT-2500/L		
BSN18-C	22 – 18 AWG	Red	0.115	1.15		CT-100, CT-1550, CT-1551, CT-2300/ST, CT-2500/L, UP14ZLW	100	1000
BSN14-C	16 – 14 AWG	Blue	0.148			CT-100, CT-1550, CT-1551, CT-2300/ST, CT-2500/L, UP14ZLW		
BSN10-L	12 – 10 AWG	Yellow	0.210	1.14		CT-100, CT-1550, CT-1551, CT-2300/ST, CT-2500/L, UP14ZLW	50	500

*Not UL or CSA Listed.

**Bulk packaging may be available, contact Panduit® Customer Service for additional information.



Butt Splice, Vinyl Insulated

Type BSV

- Expanded wire entry designed to accommodate wire with a larger insulation thickness
- Designed to splice two solid or stranded wires together to repair or lengthen wires
- Brazed seam protects terminal barrel from splitting during the crimp process
- Internal wire stop assures proper length of insertion into terminal barrel
- UL Flammability UL 94V-0, maximum insulation temperature 221°F (105°C)
- UL and CSA rated up to 600V per UL 486C

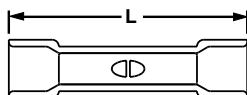

Part Number	Wire Range	Color Code	Max Ins. (In.)	Figure Dimensions (In.)		Recommended Installation Tool	Std. Pkg. Qty.**	Std. Ctn. Qty.
				L				
BSV18X-LY	22 – 18 AWG	Red	0.170	1.03		CT-100, CT-1550, CT-1551, CT-2300/ST, CT-2500/L, UP14ZLW	50	500
BSV14X-L	16 – 14 AWG	Blue	0.200	1.04				
BSV10X-Q	12 – 10 AWG	Yellow	0.250	1.18			25	250

**Bulk packaging may be available, contact Panduit Customer Service for additional information.

www.panduit.com



Parallel Splice, Non-Insulated

Type PS

- Designed to splice two solid or stranded wires together to repair or lengthen wires
- Parallel design results in only one crimp required to complete splice
- Seamless tubular barrel provides a consistent high performance quality crimp
- Non-insulated barrel can be used to provide an economical termination when insulation is not required
- Maximum recommended operating temperature 302°F (150°C)
- UL and CSA rated up to 2000V per UL 486C

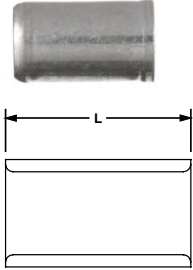

Part Number	Wire Range	Figure Dimensions (In.)	Wire Strip Length (In.)	Recommended Installation Tool	Std. Pkg. Qty.**	Std. Ctn. Qty.
		L				
PS12-L	14 – 12 AWG	0.38	7/16	CT-100, CT-200	50	500

**Bulk packaging may be available, contact Panduit® Customer Service for additional information.



Wire Joint, Nylon Insulated

Type JN

- Large barrel, designed to accommodate from one to seven wires with just one crimp
- Accommodates multiple wire sizes in varying combinations
- Barrel of terminal internally beveled to provide quick and easy wire insertion
- UL Flammability UL 94 HB, maximum insulation temperature 221°F (105°C)
- UL and CSA rated up to 600V per UL 486C



Part Number	Wire Range	Color Code	CMA Range		Figure Dimensions (In.)	Wire Strip Length (In.)	Recommended Installation Tool	Std. Pkg. Qty.**	Std. Ctn. Qty.
			Min	Max	L				
JN218-216-C	(2) #22 – (2) #16	Clear	1284	5160	0.78	7/16	CT-1550‡, CT-1551‡, CT-2300/ST, CT-2500/L	100	1000
JN418-212-C	(4) #18 – (2) #12		6480	14750	0.93	1/2	CT-100‡, CT-1550‡, CT-1551‡, CT-2300/ST, CT-2500/L		
JN314-412-C*	(3) #14 – (4) #12		10320	26120	0.97	5/8	CT-100, CT-160, CT-260		

*Not UL or CSA Listed.

**Bulk packaging may be available, contact Panduit Customer Service for additional information.

‡UL and CSA approved tooling/product combinations. For crimping tool information see www.panduit.com.

Note: Wire combinations using #24 AWG wire are not UL Listed or CSA Certified.



Heat Shrink, Butt Splices

Type BSH

- Designed to splice two stranded wires together to repair or lengthen wires
- Butted configuration provides low profile for limited space applications
- Heat shrink polyolefin sleeve with hot melt adhesive protects against moisture
- After crimping, heat shrink insulation is completed with a standard heat gun
- Minimum continuous operating temperature -65°F (-55°C)
- Maximum continuous operation temperature 230°F (110°C)
- Shrink temperature 300°F (150°C)
- UL and CSA rated up to 600V per UL 486C

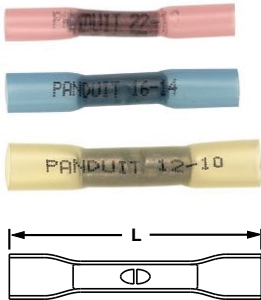

Part Number	Wire Range	Color Code	Max Ins. (In.)	Figure Dimensions (in)	Wire Strip Length (In.)	Recommended Installation Tool	Std. Pkg. Qty.**	Std. Ctn. Qty.
				L				
BSH18-Q	22 – 18 AWG	Red	0.170	1.45	5/16	CT-310	25	125
BSH14-Q	16 – 14 AWG	Blue	0.190					
BSH10-E	12 – 10 AWG	Yellow	0.240	1.64			20	100

**Bulk packaging may be available, contact Panduit Customer Service for additional information.

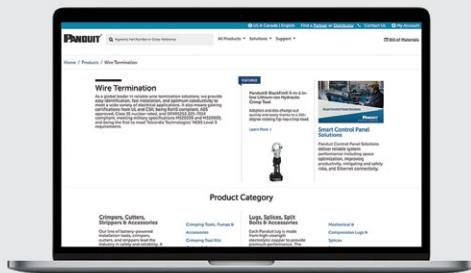

Like what you see? Want more?

Visit www.panduit.com for the full offering of Panduit products



Insulated Ferrules – Single Wire DIN End Sleeve

Type FSD

- Polypropylene insulation housing conforms to DIN color requirements
- Meets DIN standards for single wire containment
- Funnel entry for faster insertion and lower installed cost
- Designed with a seamless barrel to contain loose wire strands for superior terminations
- Eases insertion of wire into terminal block
- Suitable for limited space panel applications
- Multiple pin lengths available for a variety of terminal blocks

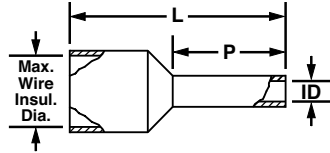

Part Number	Wire Size		Color Code	Max. Wire Insul. Dia.		Figure Dimensions						Wire Strip Length		Recommended Installation Tool	Std. Pkg. Qty.				
	AWG	mm ²		In.	mm	L		P		ID		In.	mm						
FSD73-8-D [^]	24 AWG	0.25	Yellow	0.07	2.0	0.49	12.5	0.31	8.0	0.03	0.8	15/32	11.9	CT-1002, CT-1123, CT-2523CH	500				
FSD74-8-D [^]	24-22 AWG	0.34	Turquoise			0.53	13.5									0.04	1.1	17/32	13.5
FSD75-8-D [*]	22-20 AWG	0.5	White	0.61	15.5	0.39	10.0	15/32	11.9										
FSD75-10-D [*]				0.55	14.0	0.31	8.0			0.05	1.3	17/32	13.5						
FSD76-8-D	18 AWG	0.75	Gray	0.63	16.0	0.39	10.0	3/8	9.5										
FSD76-10-D				0.49	12.5	0.24	6.0			0.06	1.5	17/32	13.5						
FSD77-6-D	-	1.0	Red	0.11	2.8	0.65	16.5	0.39	10.0					5/8		15.9	CT-1090, CT-1002, CT-1003, CT-1123, CT-1160, CT-1170, CD-090 ^{***} , CT-2523CH		
FSD77-10-D						0.73	18.5	0.47	12.0										
FSD77-12-D						0.57	14.5	0.31	8.0										
FSD78-8-D	16 AWG	1.5	Black	0.12	3.0	0.07	1.8	15/32	11.9	17/32	13.5	5/8	15.9	CT-1090, CT-1002, CT-1003, CT-1123, CT-1160, CT-1170, CD-090 ^{***} , CT-2523CH					
FSD78-10-D																0.65	16.5	0.39	10.0
FSD78-12-D																0.73	18.5	0.47	12.0
FSD80-8-D	14 AWG	2.5	Blue	0.17	4.2	0.09	2.3	15/32	11.9	5/8	15.9	CT-1090, CT-1002, CT-1003, CT-1123, CT-1160, CT-1170, CD-090 ^{***} , CT-2523CH							
FSD80-12-D													0.59	15.0		0.31	8.0		
FSD81-10-D	12 AWG	4.0	Gray	0.19	4.8	0.11	2.9	17/32	13.5	5/8	15.9	CT-1090, CT-1002, CT-1003, CT-1123, CT-1160, CT-1170, CD-090 ^{***} , CT-2523CH							
FSD81-12-C													0.69	17.5	0.39	10.0			
FSD82-12-C	10 AWG	6.0	Yellow	0.24	6.2	0.14	3.6	5/8	15.9	CT-1090, CT-1002, CT-1123, CT-1003 [‡] , CT-1160, CT-1170, CD-090 ^{***} , CT-2523CH	100								

[^]Not UL or CSA Listed.

[‡] Tool/part not a UL listed combination For crimping tool information see www.panduit.com.

^{*}Not UL listed with 22 AWG wire

^{***}Dies used [CT-2300](#) series Tool

Continued on next page



Insulated Ferrules – Single Wire DIN End Sleeve (continued)

Part Number	Wire Size		Color Code	Max Wire Insul. Dia.		Figure Dimensions						Wire Strip Length		Recommended Installation Tool	Std. Pkg. Qty.
	AWG	mm ²		In.	mm	L		P		ID		In.	mm		
						In.	mm	In.	mm	In.	mm	In.	mm		
FSD83-12-C	8 AWG	10.0	Red	0.30	7.5	0.83	21.0	0.47	12.0	0.18	4.6	5/8	15.9	CT-1003‡, CT-1004‡, CT-1123, CT-1104, CT-1160, CT-1170, CD-090***, CT-1090, CT-2504CH, CT-2523CH	100

^Not UL or CSA Listed.

‡Tool/part not a UL listed combination For crimping tool information see www.panduit.com.

*Not UL listed with 22 AWG wire

***Dies used CT-2300 series Tool



Insulated Ferrules – Twin Wire DIN End Sleeve

Type FTD

- Meets DIN standards for twin wire containment
- Polypropylene insulation housing conforms to DIN color requirements

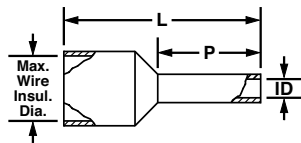

- Funnel entry for faster insertion and lower installed cost
- Designed with a seamless barrel to contain loose wire strands for superior terminations
- Eases insertion of wire into terminal block
- Suitable for limited space panel applications
- Multiple pin lengths available for a variety of terminal blocks

Part Number	Wire Size		Color Code	Max. Wire Insul. Dia.		Figure Dimensions						Wire Strip Length		Recommended Installation Tool	Std. Pkg. Qty.
	AWG	mm ²		In.	mm	L		P		ID		In.	mm		
						In.	mm	In.	mm	In.	mm	In.	mm		
FTD75-8-D*	22-20 AWG	0.5	White	0.87	2.2	0.59	15.0	0.31	8.0	0.06	1.5	7/16	11.2	CD-090**, CT-1002, CT-1003+, CT-1090, CT-1160, CT-1170, CT-1123, CT-2523CH***	500
FTD77-8-D	-	1.0	Red	0.11	2.7										
FTD77-10-D						16 AWG	1.5	Black	0.12	3.0	0.63	16.0	0.31		
FTD78-8-D	14 AWG	2.5	Blue	0.15	3.7										
FTD78-12-D						14 AWG	2.5	Blue	0.15	3.7	0.73	18.5	0.39		
FTD80-10-TL	14 AWG	2.5	Blue	0.15	3.7										
FTD80-13-TL						12 AWG	4.0	Gray	0.17	4.3	0.91	23.0	0.47	12.0	0.15
FTD81-12-C	10 AWG	6.0	Yellow	0.19	4.8										
FTD82-14-C						10 AWG	6.0	Yellow	0.19	4.8	0.98	25.0	0.55	14.0	0.18

*UL listed with 20 AWG only, UL486F scope is 1/0-20AWG. White is DIN color for 20 AWG

+Tool/part is not a UL listed combination.

For crimping tool information see www.panduit.com.

**For use with CT-2300/ST or CT-2500CH crimp head

***Crimp head for use with CT-2500/L tool

www.panduit.com



Insulated Ferrules on Strips – Single Wire

Type FSD

- Polypropylene insulation housing available in DIN standard colors in strips of 50

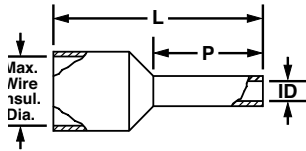

- Continuously molded design provides consistent placement of ferrules in tool to ensure fast, reliable terminations
- Available in #20 – 14 AWG featuring a seamless barrel design to contain loose wire strands for superior terminations
- Designed for use with the Semiautomatic Ferrule Crimping Tool CT-1000 for medium volume applications

DIN End Sleeves

Part Number	Wire Size		Color Code	Max. Wire Insul. Dia.		Figure Dimensions						Wire Strip Length		Recommended Installation Tool	Std. Pkg. Qty.
	AWG	mm ²		In.	mm	L		P		ID		In.	mm		
FSD78-8-DSL0	16 AWG	1.50	Black	0.13	3.2	0.60	15.2	0.31	8.0	0.09	2.3	13/32	10.0	CT-1000	500



Ferrules, Non-Insulated

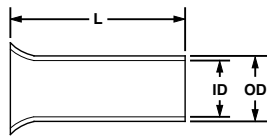

Type F

- Designed with a seamless barrel to contain loose wire strands for superior terminations
- Eases insertion of wire into terminal block
- Meets DIN standards for wire containment
- Suitable for limited space panel applications
- Multiple pin lengths available for a variety of terminal blocks

Part Number	Wire Size		Figure Dimensions						Wire Strip Length		Recommended Installation Tool	Std. Pkg. Qty.
	AWG	mm ²	L		ID		OD		In.	mm		
F83-12-D‡	8 AWG	10.0	0.47	12.0	0.18	4.5	0.19	4.9	15/32	12.0	CD-090**, CT-1003+, CT-1004+, CT-1090, CT-1104, CT-1123, CT-1160, CT-1170, CT-2504CH***, CT-2523CH***	500
F86-25-C	2 AWG	35.0	0.98	25.0	0.33	8.3	0.34	8.7	31/32	25.0	CT-1005	100
F89-25-L*	2/0	70.0			0.49	12.5	0.52	13.3			CD-920-F89^^ CD-2001-F89^^^	50

*Not UL listed, UL486F scope is 20 - 1/0 AWG only

**For use with [CT-2300/ST](#) or [CT-2500CH](#) crimp head

***Crimp head for use with [CT-2500/L](#) tool

^^Dies compatible for use with [CT-3001/ST](#), [CT-3001/CCP](#), [CT-930LPCH](#) tools

^^^Dies compatible for use with CT-2001 and CT-3001 tools

Ferrule Assortment Kits

- Large selection of ferrules in a convenient compact case
- Plastic case is both durable and reusable keeping ferrules organized and separated



Part Number	Part Description	Std. Pkg. Qty.
KP-FSD2	Ferrule kit includes: #22 – 14 AWG insulated DIN ferrules. Case includes: 100 pieces each of FSD76-8 , FSD77-8 , FSD78-8 50 pieces each of FSD75-8 and FSD80-8 .	1

Ferrule kits do not include crimping tool.



Ring Terminals, Nylon Insulated – Non-Funnel Entry

Type PN-R

- Continuously molded design provides reliable, consistent performance through the applicator for a high quality termination every time
- Ring tongue design assures a secure connection in high vibration applications
- Metal insulation grip sleeve crimps to wire insulation, providing protection to the crimp joint during high vibration applications
- Internal barrel serrations assure good wire contact and maximum tensile strength
- UL Flammability UL 94 HB, maximum insulation temperature 221°F (105°C)
- UL and CSA rated up to 600V per UL 486A/B

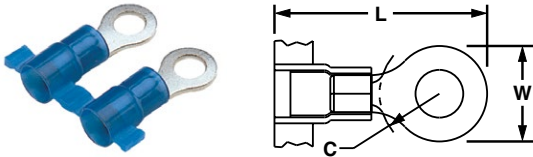

Part Number	Wire Range	Color Code	Stock Thickness (In.)	Max Ins. (In.)	Stud Size	Figure Dimensions (In.)			CA9 Series Crimp Die	CA-800/EZ Series Crimp Die	Pieces Per Reel
						L	W	C			
PN18-10R-3K	22 – 18 AWG	Red	0.03	0.145	#10	0.86	0.31	0.25	CD9-1A	CD-800-1	3000
PN14-10R-3K	16 – 14 AWG	Blue		0.162					CD9-2A	CD-800-2	



Ring Terminals, Nylon Insulated – Funnel Entry

Type PNF-R

- Continuously molded design provides reliable, consistent performance through the applicator for a high quality termination every time
- Ring tongue design assures a secure connection in high vibration applications
- Metal insulation grip sleeve crimps to wire insulation, providing protection to the crimp joint during high vibration applications
- Internal barrel serrations assure good wire contact and maximum tensile strength
- UL Flammability UL 94 HB, maximum insulation temperature 221°F (105°C)
- UL and CSA rated up to 600V per UL 486A/B

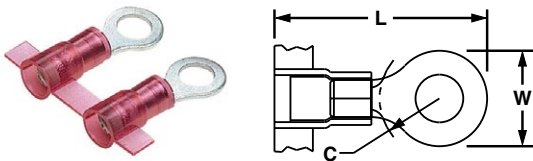

Part Number	Wire Range	Color Code	Stock Thickness (In.)	Max Ins. (In.)	Stud Size	Figure Dimensions (In.)			CA9 Series Crimp Die	CA-800/EZ Series Crimp Die	Pieces Per Reel
						L	W	C			
PNF18-10R-3K	22 – 18 AWG	Red	0.03	0.145	#10	0.86	0.31	0.25	CD9-1A	CD-800-1	3000
PNF14-10R-3K	16 – 14 AWG	Blue		0.162					0.85	0.29	
PNF10-10R-2K	12 – 10 AWG	Yellow	0.04	0.225		1/4"	1.06	0.38	0.31	CD9-3B	
PNF10-14R-2K					1/4"	1.21	0.52	0.38			



Ring Terminals, Vinyl Insulated – Funnel Entry

Type PV-RB

- Continuously molded design provides reliable, consistent performance through the applicator for a high quality termination every time
- Ring tongue design assures a secure connection in high vibration applications
- Insulation support helps to prevent wire damage in bending applications
- UL Flammability UL 94V-0, maximum insulation temperature 221°F (105°C)
- UL and CSA rated up to 600V per UL 486A/B

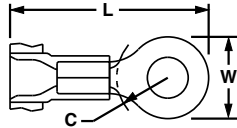

Part Number	Wire Range	Color Code	Stock Thickness (In.)	Max Ins. (In.)	Stud Size	Figure Dimensions (In.)			CA9 Series Crimp Die	CA-800/EZ Series Crimp Die	Pieces Per Reel
						L	W	C			
PV18-6RB-3K	22 – 18 AWG	Red	0.03	0.150	#6	0.78	0.25	0.20	CD9-1A	CD-800-1	3000
PV18-8RB-3K					#8	0.86	0.31	0.25			
PV18-10RB-3K					#10	1.06	0.45	0.38			
PV18-14RB-3K					1/4"	1.15	0.53	0.43			
PV18-38RB-2K					3/8"	—	CD-800-1	2000			
PV14-8RB-3K	16 – 14 AWG	Blue	0.170	0.170	#8	0.86	0.31	0.25	CD9-2A	CD-800-2	3000
PV14-10RB-3K					#10	1.05	0.45	0.38			
PV14-14RB-3K					1/4"	1.06	0.46	0.38			
PV14-56RB-2K					5/16"	—	CD-800-2	2000			
PV10-8RB-2K	12 – 10 AWG	Yellow	0.04	0.225	#8	1.02	0.31	0.31	CD9-3B	CD-800-3	2000
PV10-10RB-2K					#10						
PV10-14RB-2K					1/4"						
PV10-56RB-2K					5/16"						
PV10-38RB-2K					3/8"						

BEST SELLER



Locking Fork Terminals, Nylon Insulated – Funnel Entry

Type PNF-LF

- Continuously molded design provides reliable, consistent performance through the applicator for a high quality termination every time
- Snap in place for secure connection
- Fork design provides for fast and easy installation, without the need to remove fastener
- Metal insulation grip sleeve crimps to wire insulation, providing protection to the crimp joint during high vibration applications
- Internal barrel serrations assure good wire contact and maximum tensile strength
- UL Flammability UL 94 HB, maximum insulation temperature 221°F (105°C)
- UL and CSA rated up to 600V per UL 486A/B

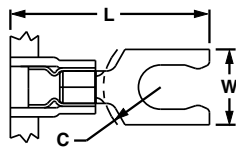

Part Number	Wire Range	Color Code	Stock Thickness (In.)	Max Ins. (In.)	Stud Size	Figure Dimensions (In.)			CA9 Series Crimp Die	CA-800/EZ Series Crimp Die	Pieces Per Reel
						L	W	C			
PNF14-8LF-3K	16 – 14 AWG	Blue	0.03	0.162	#6	0.92	0.29	0.23	CD9-2A	CD-800-2	3000



Locking Fork Terminals, Vinyl Insulated – Funnel Entry

Type PV-LFB

- Continuously molded design provides reliable, consistent performance through the applicator for a high quality termination every time
- Snap in place for secure connection
- Fork design provides for fast and easy installation, without the need to remove fastener
- Insulation support helps to prevent wire damage in bending applications
- UL Flammability UL 94V-0, maximum insulation temperature 221°F (105°C)
- UL and CSA rated to 600V per UL 486A/B

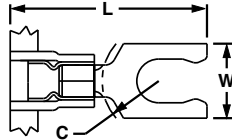

Part Number	Wire Range	Color Code	Stock Thickness (In.)	Max Ins. (In.)	Stud Size	Figure Dimensions (In.)			CA9 Series Crimp Die	CA-800/EZ Series Crimp Die	Pieces Per Reel
						L	W	C			
PV18-6LFB-3K	22 – 18 AWG	Red	0.03	0.150	#6	0.80	0.27	0.19	CD9-1A	CD-800-1	3000
PV18-8LFB-3K						0.87	0.29	0.23			
PV10-8LFB-2K	12 – 10 AWG	Yellow	0.04	0.225	#8	1.04	0.30	0.21	CD9-3B	CD-800-3	2000

*Not UL Listed or CSA Certified.



Female Disconnects, Nylon Fully Insulated – Funnel Entry

Type DNF-FIB

- Continuously molded design provides reliable, consistent performance through the applicator for a high quality termination every time
- Disconnect can be inserted and removed from the male tab without the use of tools for lower installed cost
- Fully insulated design provides protection from electrical shorts
- Disconnects available in common industry tab sizes
- Internal wire stop assures proper length of insertion into terminal barrel, providing a higher quality connection
- UL Flammability UL 94 HB, maximum insulation temperature 221°F (105°C)
- UL and CSA rated up to 600V per UL 310

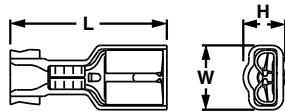

Part Number	Wire Range	Color Code	Max Ins. (In.)	Figure Dimensions (In.)			Tab Size		CA9 Series Crimp Die	CA-800/EZ Series Crimp Die	Pieces Per Reel
				L	W	H	In.	mm			
DNF18-111FIB-3K*	22 – 18 AWG	Red	0.120	0.71	0.19	0.15	0.110 x 0.020	2.8 x 0.5	CD9-7A	CD-800-7	3000
DNF18-188FIB-3K				0.78	0.16	0.187 x 0.020	4.8 x 0.5				
DNF18-206FIB-3K			0.136	0.31	0.22	0.187/0.205 x 0.020	4.8/5.2 x 0.5	CD9-4A	CD-800-4		
DNF18-250FIB-3K**				0.84							
DNF14-250FIB-3K	16 – 14 AWG	Blue	0.160	0.35		0.250 x 0.032	6.3 x 0.8	CD9-5A	CD-800-5		
DNF10-250FIB-2K	12 – 10 AWG	Yellow	0.220	0.96		0.23			CD9-13B	CD-800-13	2000

*UL/CSA standards do not exist for 0.110" x 0.010" receptacles.

**UL with 17 AWG wire.



Disco™ Female Disconnects, Nylon Fully Insulated – Expanded Wire Entry

Type DNF-FIBX

- Continuously molded design provides reliable, consistent performance through the applicator for a high quality termination every time
- Disconnect can be inserted and removed from the male tab without the use of tools for lower installed cost
- Expanded wire entry designed to accommodate wire with a larger insulation thickness
- Fully insulated design provides protection from electrical shorts
- Internal wire stop assures proper length of insertion into terminal barrel, providing a higher quality connection
- UL Flammability UL 94 HB, maximum insulation temperature 221°F (105°C)
- UL and CSA rated up to 600V per UL 310

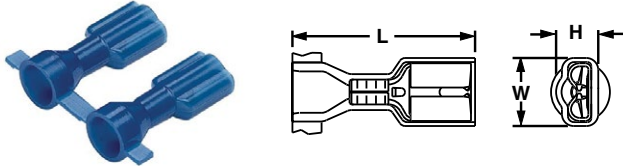

Part Number	Wire Range	Color Code	Max Ins. (In.)	Figure Dimensions (In.)			Tab Size		CA9 Series Crimp Die	CA-800/EZ Series Crimp Die	Pieces Per Reel
				L	W	H	In.	mm			
DNF18206FIBX-2K	22 – 18 AWG	Red	0.210	0.87	0.31	0.22	0.187/0.205 x 0.020	4.8/5.2 x 0.5	CD9-6B	CD-800-6	2000
DNF18250FIBX-2K				0.93	0.35						
DNF14250FIBX-2K	16 – 14 AWG	Blue	0.240								



Disco™ Female Disconnects, Nylon Fully Insulated – Right Angle

Type DNFR-FIB

- Continuously molded design provides reliable, consistent performance through the applicator for a high quality termination every time
- Right angle design for use in limited space applications
- Fully insulated design provides protection from electrical shorts
- Internal wire stop assures proper length of insertion into terminal barrel, providing a higher quality connection
- Disconnect can be inserted and removed from the male tab without the use of tools for lower installed cost
- UL Flammability UL 94 HB, maximum insulation temperature 221°F (105°C)
- UL and CSA rated up to 600V per UL 310

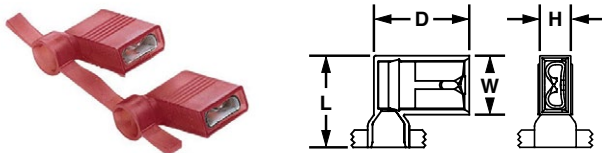

Part Number	Wire Range	Color Code	Max Ins. (In.)	Figure Dimensions (In.)				Tab Size		CA9 Series Crimp Die	CA-800/EZ Series Crimp Die	Pieces Per Reel
				L	W	H	D	In.	mm			
DNFR18205FIB-KD	22 – 18 AWG	Red	0.178	0.57	0.37	0.21	0.60	0.187/0.205 x 0.032	4.8/5.2 x 0.8	CD9-9C	CD-800-9	1500
DNFR18206FIB-KD								0.187/0.205 x 0.020	4.8/5.2 x 0.5			
DNFR18250FIB-KD								0.250 x 0.032	6.3 x 0.8			
DNFR14250FIB-KD	16 – 14 AWG	Blue										



Disco™ Female Disconnects, Vinyl Barrel Insulated – Funnel Entry

Type DV-B

- Continuously molded design provides reliable, consistent performance through the applicator for a high quality termination every time
- Disconnect can be inserted and removed from the male tab without the use of tools for lower installed cost
- Internal barrel serrations assure good wire contact and maximum tensile strength
- Internal wire stop assures proper length of insertion into terminal barrel, providing a higher quality connection
- UL Flammability UL 94V-0, maximum insulation temperature 221°F (105°C)
- UL and CSA rated up to 600V per UL 310

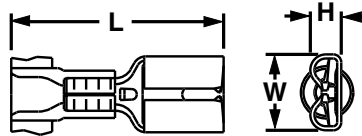

Part Number	Wire Range	Color Code	Max Ins. (In.)	Figure Dimensions (In.)			Tab Size		CA9 Series Crimp Die	CA-800/EZ Series Crimp Die	Pieces Per Reel
				L	W	H	In.	mm			
DV18-250B-3K	22 – 18 AWG	Red	0.150	0.83	0.29	0.12	0.250 x 0.032	6.3 x 0.8	CD9-1A	CD-800-1	3000
DV14-250B-3K	16 – 14 AWG	Blue	0.170						CD9-2A	CD-800-2	
DV10-250-2K*	12 – 10 AWG	Yellow	0.230	0.95					CD9-3B	CD-800-3	2000

*Not UL Listed or CSA Certified.



DiscoGrip™ Female Disconnects, Fully Insulated

Type DPF-FIB

- Continuously molded design provides reliable, consistent performance through the applicator for a high quality termination every time
- Disconnect can be inserted and removed from the male tab without the use of tools for lower installed cost
- Premium nylon insulation retains its shape when crimped and provides a tight grip around the wire insulation for maximum strain relief
- Fully insulated design provides protection from electrical shorts
- Internal wire stop assures proper length of insertion into terminal barrel, providing a higher quality connection
- Maximum insulation temperature 221°F (105°C)
- UL and CSA rated up to 600V per UL 310

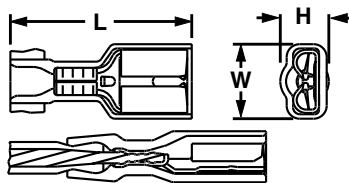

Part Number	Wire Range	Color Code	Max Ins. (In.)	Figure Dimensions (In.)			Tab Size		CA9 Series Crimp Die	CA-800/EZ Series Crimp Die	Pieces Per Reel
				L	W	H	In.	mm			
DPF14-250FIB-3K	16 – 14 AWG	Blue	0.160	0.84	0.35	0.22	0.250 x 0.032	6.3 x 0.8	CD9-11A	CD-800-11	3000



Disco™ Male Disconnects, Nylon Fully Insulated – Funnel Entry

Type DNF-FIM

- Continuously molded design provides reliable, consistent performance through the applicator for a high quality termination every time
- Male tab couples with (all 0.250 x 0.032) female disconnects
- Fully insulated design provides protection from electrical shorts
- Male tab can be inserted and removed from the female disconnect without the use of tools for lower installed cost
- UL Flammability UL 94 HB, maximum insulation temperature 221°F (105°C)
- UL and CSA rated up to 600V per UL 310

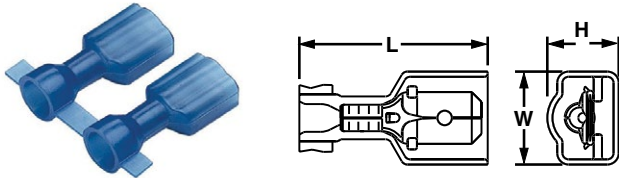

Part Number	Wire Range	Color Code	Max Ins. (In.)	Figure Dimensions (In.)			Tab Size		CA9 Series Crimp Die	CA-800/EZ Series Crimp Die	Pieces Per Reel
				L	W	P	In.	mm			
Standard Housing											
DNF18-250FIM-2K	22 – 18 AWG	Red	0.133	0.90	0.42	0.30	0.250 x 0.032	6.3 x 0.8	CD9-4B	CD-800-4	2000
DNF14-250FIM-2K	16 – 14 AWG	Blue	0.158						CD9-5B	CD-800-5	
Oversized Housing											
DNF18-250FIMB-K*	22 – 18 AWG	Red	0.135	0.91	0.45	0.34	0.250 x 0.032	6.3 x 0.8	CD9-4B	CD-800-4	1000
DNF14-250FIMB-K*	16 – 14 AWG	Blue	0.160		0.46				CD9-5B	CD-800-5	

*To mate with other manufacturers' fully insulated 0.250 x 0.032 female receptacles.



Butt Splices Nylon Insulated

Type BSN, BSP

- Continuously molded design provides reliable, consistent performance through the applicator for a high quality termination every time
- Designed to splice two solid or stranded wires together to repair or lengthen wires
- Butted configuration provides low profile for limited space applications
- Brazed seam protects terminal barrel from splitting during the crimp process
- Internal wire stop assures proper length of insertion into terminal barrel
- UL Flammability UL 94HB, maximum insulation temperature 221°F (105°C)
- UL and CSA rated up to 600V per UL 486C

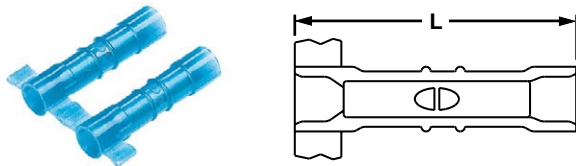

Part Number	Wire Range	Color Code	Max Ins. (In.)	Figure Dimensions (In.)	CA9 Series Crimp Die	CA-800/EZ Series Crimp Die	Pieces Per Reel
				L			
BSN18-3K	22 – 16 AWG	Red	0.150	0.95	CD9-1A	CD-800-1	3000
BSN14-3K	18 – 14 AWG	Blue	0.170		CD9-2A	CD-800-2	



Insulated Ferrules on Reels – Single Wire and Mini Reels

Type FS

- Polypropylene insulation housing available in DIN standard colors in reels of 500 - 3000
- Designed specifically for use with Ferrule Applicator for high volume applications
- Continuously molded design provides consistent placement of ferrules in applicator to ensure fast, reliable terminations
- Available in #20 – 14 AWG featuring a seamless barrel design to contain loose wire strands for superior terminations

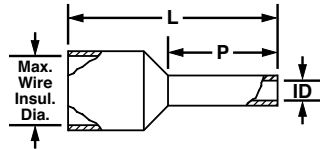

DIN End Sleeves

Part Number	Wire Size		Color	Max. Wire Ins. Dia.		Figure Dimensions						Wire Strip Length		CP-881 Inserts	Pieces per Reel
	AWG	mm ²		In.	mm	L		P		ID		In.	mm		
FSD77-8-3K2	—	1	Red	0.11	2.8	0.57	14.5	0.31	8	0.06	1.5	13/32	10.0	Red	3000
FSD78-8-2KD0	16 AWG	1.5	Black	0.13	3.2					0.07	1.8			Black	2500

***SCA-712022002 (CA10 applicator) and APM-MRSP1516JMD are no longer available. However, compatible dies are available.

Mini Reels

Part Number	Wire Size		Color	Max. Wire Ins. Dia.		Figure Dimensions						Wire Strip Length		CP-881 Inserts	Pieces per Reel
	AWG	mm ²		In.	mm	L		P		ID		In.	mm		
FSD77-8-K	—	1	Red	0.11	2.8	0.57	14.5	0.31	8	0.06	1.5	13/32	10.0	Red	1000

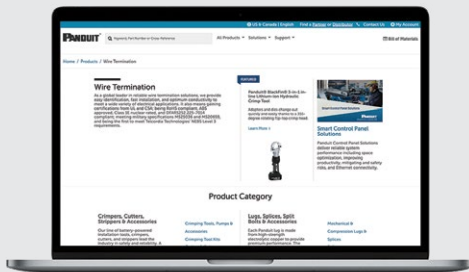

Like what you see? Want more?

Visit www.panduit.com for the full offering of Panduit products

Features and Benefits – Panduit® Type F Narrow Slot Wiring Duct



Panduit® Type F Narrow Slot Wiring Duct

- Narrow slot/finger design provides more slots to fit the spacing of high-density terminal blocks and other hardware
- Material: Lead-free PVC
- UL recognized continuous use temperature: 122°F (50°C)
- UL 94 flammability rating of V-0

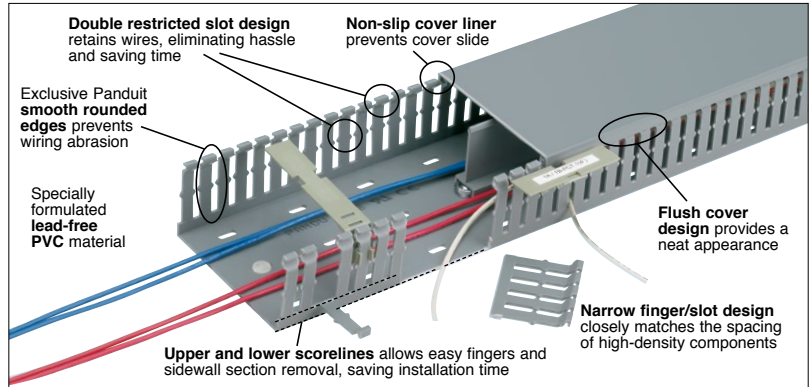

- Conforms with NFPA 79-2015 section 13.3.1 requirement for flame retardant material
- Provided with mounting holes
- Base and cover length is 6 feet

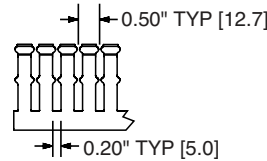
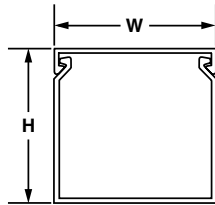
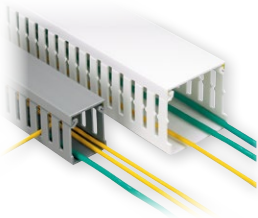

Multiple slot restrictors present with 2" and greater duct wall height.

Part Number	Duct Size (W x H)*		Slot Width		Cover Part Number	Std. Pkg. Qty.	Base Ctn. Qty.	Cover Ctn. Qty.
	In.	mm	In.	mm				
F.75X1.5LG6	0.94 x 1.57	23.6 x 39.9	0.20	5.0	C.75LG6	6	120	120
F1X1LG6	1.25 x 1.13	32.0 x 28.7			C1LG6			
F1X1.5LG6	1.25 x 1.62	32.0 x 41.1			C1LG6			
F1X2LG6	1.25 x 2.12	32.0 x 53.8			C1LG6			
BEST SELLER F1X3LG6	1.25 x 3.13	32.0 x 79.4			C1LG6			
F1X4LG6	1.25 x 4.10	32.0 x 104.1			C1LG6			
F1.5X1.5LG6	1.75 x 1.62	44.5 x 41.1			C1.5LG6			
F1.5X2LG6	1.75 x 2.12	44.5 x 53.8			C1.5LG6			
BEST SELLER F1.5X3LG6	1.75 x 3.12	44.5 x 79.2			C1.5LG6			
F1.5X4LG6	1.75 x 4.10	44.5 x 104.1			C1.5LG6			
F2X2LG6	2.25 x 2.12	57.2 x 53.8			C2LG6			
BEST SELLER F2X3LG6	2.25 x 3.14	57.2 x 79.8			C2LG6			
BEST SELLER F2X4LG6	2.25 x 4.10	57.2 x 104.1			C2LG6			
F2X5LG6	2.25 x 5.10	57.2 x 129.5			C2LG6			
F2.5X3LG6	2.75 x 3.12	69.9 x 79.2			C2.5LG6			
F3X2LG6	3.25 x 2.12	82.6 x 53.8			C3LG6			
F3X3LG6	3.25 x 3.13	82.6 x 78.7			C3LG6			
BEST SELLER F3X4LG6	3.25 x 4.10	82.6 x 104.1			C3LG6			
F3X5LG6	3.25 x 5.10	82.6 x 129.5			C3LG6			
F4X3LG6	4.25 x 3.12	108.0 x 79.2			C4LG6			
BEST SELLER F4X4LG6	4.25 x 4.10	108.0 x 104.1	C4LG6					
F4X5LG6	4.25 x 5.10	108.0 x 129.5	C4LG6					
F6X4LG6	6.25 x 4.15	158.8 x 105.4	C6LG6					

Part number shown for LG (Light Gray). For other sizes and color availability visit www.panduit.com.

Base and cover sold separately.

**"H" dimension includes duct and cover.

UL LISTED CE Panduct® Type G Wide Slot Wiring Duct

- Wide slot/finger design provides greater sidewall rigidity and can be used with a wide range of wire bundle sizes
- Material: Lead-free PVC
- UL recognized continuous use temperature: 122°F (50°C)
- UL 94 flammability rating of V-0
- Conforms with NFPA 79-20 5 section 13.3.1 requirement for flame retardant material
- Provided with mounting holes
- Base and cover length is 6 feet

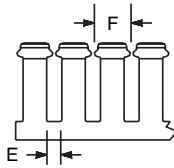
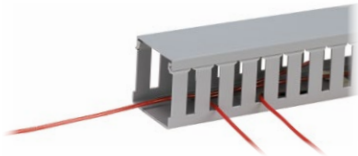

	E	F
For 0.5" duct height:	0.37" [9.4]	0.80" [20.3]
0.75" to 2" duct height:	0.31" [7.9]	0.80" [20.3]
3" to 4" duct height:	0.31" [7.9]	1.00" [25.4]
5" duct height:	0.38" [9.4]	1.33" [33.8]

Base Part Number	Duct Size (W x H)*		Slot Width		Cover Part Number	Std. Pkg. Qty.	Base Ctn. Qty.	Cover Ctn. Qty.
	In.	mm	In.	mm				
G.5X2LG6	0.69 x 2.03	17.5 x 51.6	0.31	7.9	C.5LG6	6	120	120
G.75X2LG6	0.94 x 2.03	23.6 x 51.7						
G1X1LG6	1.25 x 1.12	32.0 x 28.4						
G1X1.5LG6	1.25 x 1.62	32.0 x 41.1						
G1X2LG6	1.25 x 2.12	32.0 x 53.8						
G1X3LG6	1.25 x 3.12	32.0 x 79.2						
G1X4LG6	1.25 x 4.10	32.0 x 104.1						
G1.5X1.5LG6	1.75 x 1.62	44.5 x 41.1						
G1.5X2LG6	1.75 x 2.12	44.5 x 53.8						
G1.5X3LG6	1.75 x 3.12	44.5 x 79.2						
G1.5X4LG6	1.74 x 4.10	44.5 x 104.1						
G2X1.5LG6	2.25 x 1.62	57.2 x 41.1						
G2X2LG6	2.25 x 2.12	57.2 x 53.8						
G2X3LG6	2.25 x 3.12	57.2 x 79.2						
G2X4LG6	2.25 x 4.10	57.2 x 104.1						
G2X5LG6	2.25 x 5.10	57.2 x 129.5	0.38	9.7	C2LG6	60	120	
G3X2LG6	3.25 x 2.12	82.6 x 53.8	0.31	7.9	C3LG6			
G3X3LG6	3.25 x 3.12	82.6 x 79.2						
G3X4LG6	3.25 x 4.10	3.25 x 4.10						
G3X5LG6	3.25 x 5.10	82.6 x 129.5	0.38	9.7	C3LG6			
G4X3LG6	4.25 x 3.12	108.0 x 79.2	0.31	7.9	C4LG6			60
G4X4LG6	4.25 x 4.10	108.0 x 104.1						
G4X5LG6	4.25 x 5.10	108.0 x 129.5						
G6X4LG6	6.23 x 4.15	158.8 x 105.4	0.31	7.9	C6LG6			

Part number shown for LG (Light Gray). For other sizes and color availability visit www.panduit.com.

Base and cover sold separately.

**"H" dimension includes duct and cover.

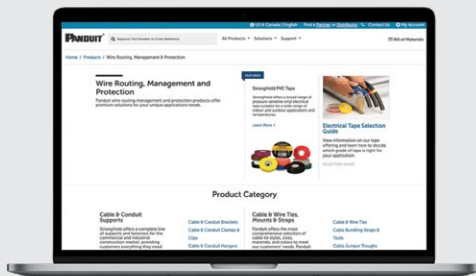

Like what you see? Want more?

Visit www.panduit.com for the full offering of Panduit products

www.panduit.com

Panduit® Type NE Halogen-Free Wiring Duct

- Material: Halogen-free polyphenylene oxide (PPO)
- UL recognized continuous use temperature: 203°F (95°C)
- UL 94 flammability rating of V-0
- Meets a Hazard Level Classification of HL1 per European Standard EN 45545-2 for R23 (exterior)
- Provided with mounting holes
- Base and cover length is 6 feet
- Conforms with NFPA 79-2015 section 13.3.1 requirement for flame retardant material

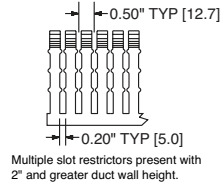
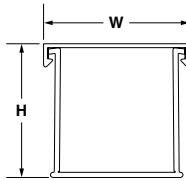

Base Part Number	Duct Size (W x H)*		Slot Width		Cover Part Number	Std. Pkg. Qty.	Base Ctn. Qty.	Cover Ctn. Qty.
	In.	mm	In.	mm				
NE1X1WH6*	1.14 x 1.06	29.0 x 26.9	0.31	7.9	NC1WH6	6	120	120
NE1X2WH6	1.14 x 2.06	29.0 x 52.3			NC1WH6			
NE1X3WH6	1.14 x 3.06	29.0 x 77.7			NC1WH6			
NE1X4WH6	1.14 x 4.06	29.0 x 103.1			NC1WH6			
NE2X1WH6	2.14 x 1.08	54.4 x 27.4	NC2WH6					
NE2X2WH6*	2.14 x 2.08	54.4 x 52.8	NC2WH6					
NE2X3WH6	2.14 x 3.06	54.4 x 77.7	NC2WH6					
NE2X4WH6	2.14 x 4.06	54.4 x 103.1	NC2WH6					
NE3X4WH6	3.14 x 4.06	79.8 x 103.1	0.38	9.7	NC3WH6		60	
NE3X5WH6	3.14 x 5.06	79.8 x 128.5			NC3WH6			
NE4X3WH6	4.14 x 3.06	105.2 x 77.7			NC4WH6			
NE4X4WH6*	4.14 x 4.06	105.2 x 103.1			NC4WH6			

*Available in the solid NS duct without mounting holes.
Available in WH (White) only.

Do not allow cutting, tapping, or cleaning fluids that contain hydrocarbons to come in contact with type NE wiring duct as it will cause stress cracking.
Base and cover sold separately.

**"H" dimension includes duct and cover.

PanelMax™ Corner Wiring Duct

- Fits in the unused space in the vertical corner of enclosures, gaining sub-panel space or saving enclosure footprint area
- One-piece base requires less time to install than multi-piece solutions
- Optional quick mount clips engage anywhere along the product base further reducing assembly costs
- Panduit divider wall snaps directly to the integrated mounting feature in the channel to create two separate channels
- Compatible with Panduit 2-inch, 3-inch, and 4-inch height wiring duct; all product sizes use standard 2-inch wiring duct cover
- Base and cover length is 6 feet
- Base and covers sold separately

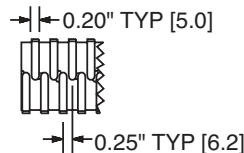
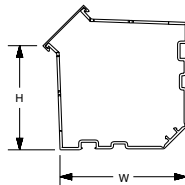

Base Part Number	Duct Size (W x H)*		Slot Width		Cover Part Number	Std. Pkg. Qty.	Base Ctn. Qty.	Cover Ctn. Qt.
	In.	mm	In.	mm				
CWD3LG6	4.40 x 3.57	111.8 x 90.7	0.2	5.0	C2LG6	6	24	120
CWD4LG6	5.33 x 4.58	135.3 x 115.7			C2LG6			

UL® CE Panduct® Flush Cover Type D Round Hole Wiring Duct

- Round hole design has multiple rows of holes to retain and support wire at variable heights and positions
- Material: Lead-free PVC
- UL recognized continuous use temperature: 122°F (50°C)
- UL 94 flammability rating of V-0
- Conforms with NFPA 79-2015 section 13.3.1 requirement for flame retardant material
- Provided with mounting holes
- Base and cover length is 6 feet

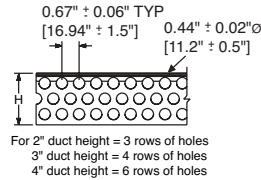
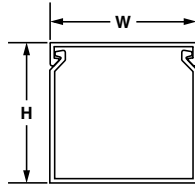
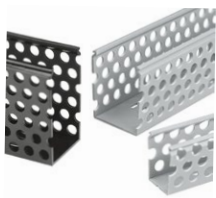

Base Part Number	Duct Size (W x H)*		Cover Part Number	Std. Pkg. Qty.	Base Ctn. Qty.	Cover Ctn. Qty.
	In.	mm				
D1.5X4LG6	1.75 x 4.10	44.5 x 104.1	C1.5LG6	6	60	120
D2X4LG6	2.25 x 4.10	57.2 x 104.1	C2LG6			

Part number shown for LG (Light Gray). For other color availability visit www.panduit.com.
Base and cover sold separately.
**H" dimension includes duct and cover.

UL® CE Panduct® PanelMax™ DIN Rail Wiring Duct

- Space saving design positions DIN rail and components off the panel directly above an integrated wire management channel for up to a 30% smaller footprint for duct and components; increased design flexibility and component access for easier installation and maintenance
- DIN rail and DIN component compatible with standard 35mm or 15mm rails and many DIN rail mount components for design flexibility
- Integrated DIN rail fastening slot allows the DIN rail to mount directly to product with plastic thread cutting screws for up to 40% faster duct and rail installation and reduced labor costs
- Hinged cover remains attached during maintenance and upgrades preventing lost covers, ensuring panel integrity, safety and aesthetics; L-shaped cover acts as ledge to aid wire installation for ease of use
- Slotted platform (horizontal) manage the wire from channel mounted components, outer sidewall slots (vertical) manage wire from adjacent panel mounted components; unique finger and slot progression for optimal wire management and aesthetics
- Channel pass through slots allows wires to transition internally between channels to ease wire connections to either side of components mounted on the same rail minimizing wire length and reducing material cost
- Optional wire retainer accessory retains cabling with cover opened or removed easing wire installation and future wire additions

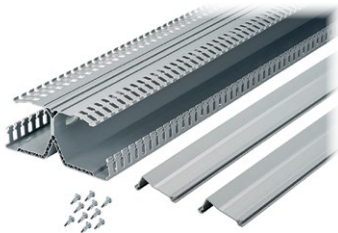

Part Number	Description	Std. Pkg. Qty.	Std. Ctn. Qty.
DRD22LG6	2" height PanelMax™ DIN Rail Wiring Duct with dual wiring channels. 6.25" W x 2.12" H (158.7mm x 54.0mm). Base, covers and DIN rail fasteners included.	6 ft	6 ft
DRD33LG6	3" height PanelMax™ DIN Rail Wiring Duct with dual wiring channels. 7.25" W x 3.14" H (184.1mm x 79.9mm). Base, covers and DIN rail fasteners included.		
DRD44LG6	4" height PanelMax™ DIN Rail Wiring Duct with dual wiring channels. 8.23" W x 4.12" H (209.0mm x 104.8mm). Base, covers and DIN rail fasteners included.		

Product sold base and cover together in 6 ft. lengths. Replace LG with WH for white color. Dimensions in parenthesis are metric.

UL® SF® Panduct® Type FL Flexible Wiring Duct

- Material: Flexible Polypropylene
- UL Recognized continuous use temperature: 149°F (65°C)
- UL 94 flammability rating of V-2
- Factory applied adhesive tape provided for easy positioning**
- Shelf Life: 5 yrs (adhesive tape)

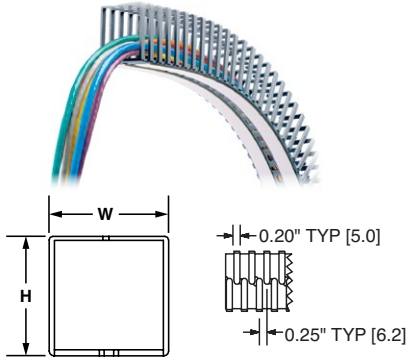

Part Number	Duct Size (W x H)*		Length		Std. Pkg. Qty.
	In.	mm	In.	mm	
FL12X12LG	0.47 x 0.47	12 x 12	19.7	500	112
FL25X25LG	0.98 x 0.98	25 x 25			70
FL50X50LG	1.97 x 1.97	50 x 50			32
FL12X12LG-AV	0.47 x 0.47	12 x 12			112
FL25X25LG-AV	0.98 x 0.98	25 x 25			70
FL50X50LG-AV	1.97 x 1.97	50 x 50			32

Available in LG (RAL 7040 Light Gray) color only. Unit of measure is pieces.

**H" dimension includes duct and cover.

**Adhesive tape is not meant for permanent mounting of wiring duct. One mounting hole on each end will be exposed for permanent mounting with fasteners. For best results, wiring duct should be applied to clean, dry, grease-free surfaces. We recommend the surface be cleaned prior to wiring duct installation.

UL® SF® CE Panduct® Type FS Solid Wall Wiring Duct

- Solid wall design fully encloses cables providing maximum protection and aesthetics
- Material: Lead-free PVC
- UL recognized continuous use temperature: 122°F (50°C)
- UL 94 flammability rating of V-0
- Base and cover length is 6 feet
- Conforms with NFPA 79-2015 section 13.3.1 requirement for flame retardant material

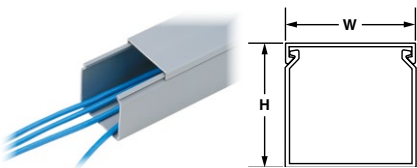

Base Part Number	Duct Size (W x H)*		Cover Part Number	Std. Pkg. Qty.	Base Ctn. Qty.	Cover Ctn. Qty.
	In.	mm				
FS2X2LG6NM*	2.25 x 2.14	57.2 x 54.4	C2LG6	6	120	120

*Parts are available with mounting holes. To order with mounting holes, remove NM from part number. Part Number shown for LG (Light Gray). For other color availability visit www.panduit.com.

Base and cover sold separately.

**H" dimension includes duct and cover.

UL® SF® CE Panduct® Type H Hinged Cover Wide Slot Wiring Duct

- Wide slot/finger design provides excellent wire management in general purpose applications and is compatible with a wide range of wire sizes and component types
- Material: Lead-free PVC
- Rated for continuous use temperature: 122°F (50°C)
- UL 94 flammability rating of V-0
- Conforms with NFPA 79-2015 section 13.3.1 requirement for flame retardant material
- Provided with standard mounting holes
- Base and cover length is 6 feet

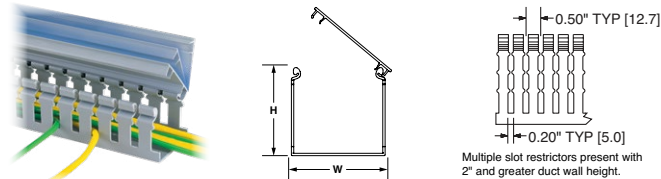

Base Part Number	Duct Size (W x H)*		Slot Width		Cover Part Number	Std. Pkg. Qty.	Base Ctn. Qty.	Cover Ctn. Qty.
	In.	mm	In.	mm				
H1.5X2LG6	1.75 x 1.98	44.5 x 50.3	0.31	7.9	HC1.5LG6	6	120	120
H2X4LG6	2.17 x 4.10	55.1 x 104.1			HC2LG6			

Part Number shown for LG (Light Gray). For other color availability visit www.panduit.com.

Base and cover sold separately.

**H" dimension includes duct and cover.

www.panduit.com

UL® CE Panduct® Type MC Metric Narrow Slot Wiring Duct

- CE compliant and metric sizing for control panels intended for European applications
- Material: Lead-free PVC
- UL recognized continuous use temperature: 122°F (50°C)
- UL 94 flammability rating of V-0
- Conforms with NFPA 79-2015 section 13.3.1 requirement for flame retardant material
- Provided with DIN 43 659 mounting holes
- Duct and cover packaged together in 2m lengths

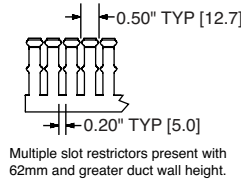
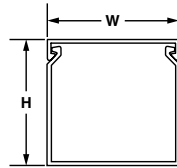
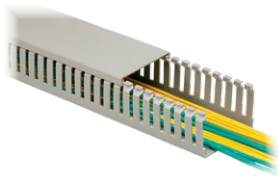

Base and Cover Part Number	Duct Size (W x H)*		Slot Width		Base and Cover Pkg. Qty. (m)
	In.	mm	In.	mm	
MC50X75IG2	1.95 x 2.85	49.5 x 72.4	0.20	5.0	10

Available in IG (International Gray) and WH (White) colors.
Base and cover sold together.
**H" dimension includes duct and cover.

UL® CE Panduct® Type NNC Halogen-Free Metric Wiring Duct

- Material: Halogen-free polyphenylene oxide (PPO) material as verified with IEC 60754-2 test method (test on gases evolved during combustion of electric cables)
- UL recognized continuous use temperature: 203°F (95°C)
- UL 94 flammability rating of V-0
- Meets a Hazard Level Classification of HL1 per European Standard EN 45545-2 for R23 (exterior).
- Conforms with NFPA 79-2015 section 13.3.1 requirement for flame retardant material
- Provided with DIN 43 659 mounting holes
- Metric sizing and finger progression
- Duct and cover packaged together in two meter lengths

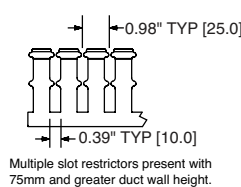
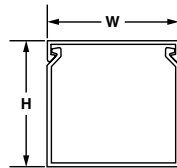
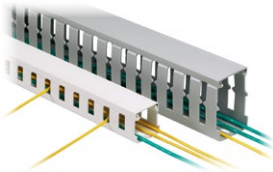

Base and Cover Part Number	Duct Size (W x H)*		Slot Width		Base and Cover Pkg. Qty. (m)
	In.	mm	In.	mm	
NNC50X75LG2	1.95 x 2.85	49.5 x 72.4	0.39	10.0	10
NNC75X75WH2	2.97 x 2.85	75.4 x 72.4			

Available in LG (Light Gray) and WH (White).
Do not allow cutting, tapping, or cleaning fluids that contain hydrocarbons to come in contact with type NNC wiring duct as it will cause stress cracking.
**H" dimension includes duct and cover.

Panduct® Type G and H Wiring Duct Wire Retainers



- Insert between fingers of type G and H to contain wiring when cover is removed
- Adjustable height
- Material: ABS

Part Number	For Nominal Duct Width In. (mm)	For Nominal Duct Height In. (mm)	Std. Pkg. Qty.	Std. Ctn. Qty.
WR2-C	2.00 (50.8)	2.00 – 4.00 (50.8 – 101.6)	100	1000

Panduct® Divider Wall

- Wiring duct divider wall can be mounted inside any type of Panduit PVC wiring duct to create multiple channels
- Simply install the divider wall base when mounting the duct and snap the divider wall onto the mounting base
- All versions snap onto DB-C mounting base
- Divider wall heights 2 inches and greater have a scoreline feature allowing sections to be removed leaving a smooth edge
- Meets UL508/508A insulation material requirement for barrier between conductors
- Divider Wall material: Lead-free PVC, UL 94 flammability rating of V-0
- Mounting base material: Polycarbonate, UL 94 flammability rating of V-2



Panduct® Divider Wall Mounting Base

Part Number	Used with Anchors	Std. Pkg. Qty.	Std. Ctn. Qty.
DB-C	Panduit NR1 or #8, #10, M4 or M5 screw	100	1000



Panduct® Slotted Divider Wall

Part Number	For Nominal Duct Height		Length		Color	Std. Pkg. Qty.	Std. Ctn. Qty.
	In.	mm	Ft.	M			
SD2H6	2.00	50	6	—	Light Gray	6	120
SD3H6	3.00	75		—			
SD4H6	4.00	100		—			

Note: Must be used with mounting base, DB-C which is sold separately. Install mounting bases to the duct channel, locate within 2" of each divider wall end and at least every 12" along the length.

Panduct® PanelMax™ Noise Shield

Dimensions are shown for reference only. Contact Panduit Customer Service at 800-777-3300 for specific dimensional needs.

- Reduces EM1/RF1 noise between sensitive and noisy wiring for up to 20dB reduction in noise, or 90% NVR (equivalent to 6 inches of air spacing); innovative design installs easily within Panduit wiring duct or when mounted separately, delivering greater design flexibility to satisfy a wide range of applications
- Perforated and pre-scored sections speed installation by allowing sections of the shield to be snapped off at pre-scored locations to easily cut to length with minimal deburring required
- Vertical wall slots allow wires to cross the barrier at 90° when necessary, providing greater design flexibility
- Horizontal cable tie slots allow cable bundles to be held in place using cable ties so cabling is kept near barrier for greater reliability and optimal aesthetics
- Zinc plated steel surface in contact areas with sub-panel and bonding clip ensures continuity and is corrosion resistant
- Black powder coated vertical surface for smooth edges
- Meets UL 508/508A requirements as a barrier between conductors

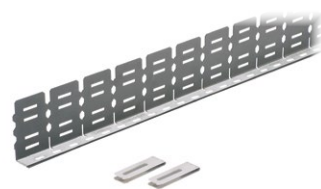

Part Number	Description	Std. Pkg. Qty.
SD2EMI	EMI Noise Shield kit for 2" height Panduit Wiring Duct; (2) three foot sections, bonding clips, and anti-oxidizing paste	1
SD3EMI	EMI Noise Shield kit for 3" height Panduit Wiring Duct; (2) three foot sections, bonding clips, and anti-oxidizing paste.	
SD4EMI	EMI Noise Shield kit for 4" height Panduit Wiring Duct; (2) three foot sections, bonding clips, and anti-oxidizing paste	

Panduit® PanelMax™ Shielding Wiring Duct

- Durable and continuous metallic foil covers and shields outer duct surfaces providing EMI/RFI noise reduction between sensitive and noisy wiring for up to 20dB reduction in noise, or 90% NVR (equivalent to 6 inches of air spacing)
- Slotted sidewalls with horizontal bridge connectors provide wire management capability and noise reduction in the full height of the duct; slot size compatible with various wire types and sizes, including UTP Ethernet cabling
- High-quality Panduit PVC wiring duct base fully contains and protects wiring, easy to cut and install, and uses standard Panduit wiring duct covers
- Installs with standard fasteners including Panduit NR1 rivets



PanelMax™ Shielded Wiring Duct

Part Number	Description	Std. Pkg. Qty.
G2X2LG6EMI	2" x 2" PanelMax™ Shielded Wiring Duct; 6-foot length. Foil metal finish includes anti-oxidizing paste. Cover sold separately.	12
G2X3LG6WMI	2" x 3" PanelMax™ Shielded Wiring Duct; 6-foot length. Foil metal finish includes anti-oxidizing paste. Cover sold separately.	
G2X4LG6WMI	2" x 4" PanelMax™ Shielded Wiring Duct; 6-foot length. Foil metal finish includes anti-oxidizing paste. Cover sold separately.	

Use C2LG6 or C2WH6 cover with shielded wiring duct. Standard package quantity in feet. For tool information refer to www.panduit.com/tools.

Performance Characteristics

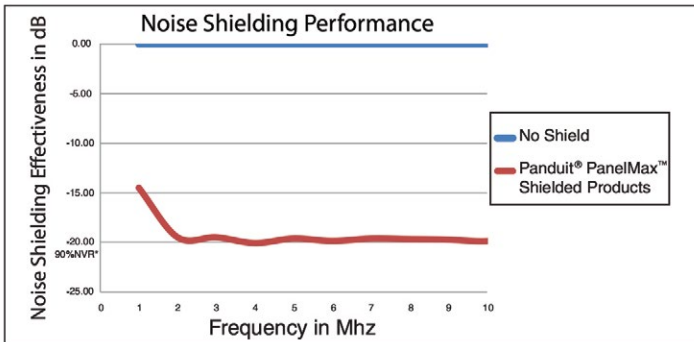

Relative noise reduction in decibels over frequency range of Panduit® PanelMax™ Shielded Wiring Duct and Noise Shield

PanelMax™ Shielded Wiring Duct and Noise Shield deliver approximately 20dB of noise reduction across common industrial noise frequencies at 30mm wire separation with an approximate 1-meter coupling length.

*NVR (Noise Voltage Reduction percentage).

Panduct® Installation Tools

Easily cut Panduct® Products with the bench mount or hand-held duct cutting tool.



Part Number	Description	Std. Pkg. Qty.
DCT	Hand-held duct cutting tool.	1
PBDCT*	Panduit bench-mount duct cutting tool. Cuts slotted wiring ducts and wiring duct covers with up to 6" width and up to 5" height. Full 78.74" (2 meter) measuring scale. Includes safety guarding.	
TNR	Hand-held nylon rivet installation tool.	
NR1-M	Nylon rivet for use with TNR rivet tool.	1000

*Product comes in two separate boxes.

Adhesive Tape Guide

Selection of wiring duct part numbers available with factory applied adhesive tape.



G Duct Light Gray	NE Duct White
G1X1LG6-A	—
G1X2LG6-A	—
G1X3LG6-A	—
—	NE2X2WH6-A
G2X3LG6-A	—

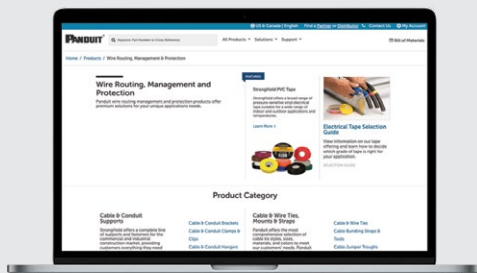

Like what you see? Want more?

Visit www.panduit.com for the full offering of Panduit products

www.panduit.com



PANDUIT®

Panduit Corp.
World Headquarters
Tinley Park, IL 60487

800.777.3300

www.panduit.com

© 2022 Panduit Corp. ALL RIGHTS RESERVED
Printed in the U.S.A.
ELCB34--SA-ENG 08/2022