

TECHNICAL GUIDE

**SINGLE PACKAGE
AIR CONDITIONER/GAS HEAT
16 SEER - R-410A - 208/230 V - 1 PHASE
2 TO 5 NOMINAL TONS
50 TO 125 MBH HEAT INPUT
MODELS: PCG6*24 TO 60**



Due to continuous product improvement, specifications are subject to change without notice.

Visit us on the web at

www.simplygettingthejobdone.com

Additional rating information can be found at

www.ahridirectory.org

WARRANTY SUMMARY*

Extended 10-year limited parts and compressor warranty.

Lifetime gas heat exchanger warranty with registration.

*Extended warranty requires online registration within 90 days of purchase for replacement or closing for new home purchase. See the limited warranty certificate in the *User's Information Manual* for details.

DESCRIPTION

These packaged cooling/heating air conditioners are designed for outdoor installation. Only utility and duct connections are required at the point of installation.

FEATURES

- **Operating Efficiency** - All PCG6 model gas units provide a minimum AFUE of 81.0% in heating and 16.0 SEER rating for cooling operation. All models meet California Low NOx requirements of 40 ng/J emission level for Air Quality Management Districts. All PCG6 models utilize a multi-stage compressor for maximum comfort and efficiency.
- **On Site Flexibility** - All model sizes use a compact design cabinet in one of two footprints. This provides installer flexibility for placing the proper capacity unit on curbs or pads with the smallest footprint after the internal load has been determined. Field convertible duct connections from side flow to downflow allows the installer to have greater flexibility with less inventory.
- **Lower Installation Cost** - Installation time and costs are reduced by easy power and control wiring connections. The small base dimension means less space is required on the ground or roof. All units are completely wired, charged with R-410A, and tested prior to shipment. Test stations using a state-of-the-art computerized process system are used to ensure product quality. Refrigerant charge and component part numbers are verified using computers during assembly. Vital run test statistics such as system pressure, motor currents, air velocity and temperature, unit vibration, and gas system safeties are monitored and recorded by the system to ensure unit performance. Equal size side supply and return duct connections allow easy connection of ducts to match low crawl spaces without transition pieces.
- **Utility Connections Made Easy** - Gas and electric utility access is provided through the bottom or the side of the unit. Utility connections can be made quickly and with a minimum amount of field labor. A field supplied and field installed electrical disconnect switch must be installed.
- **Convertible Airflow Design** - The bottom duct openings are covered when they leave the factory, ready to be used for a side supply/side return application. If a bottom supply/bottom return application is required, remove the two panels from the bottom of the unit and place them in the side supply/side return duct openings. No panel cutting is required and no accessory panel is necessary. Convertible airflow design allows maximum field flexibility and minimum inventory.
- **Condensate Pan** - A corrosion-resistant, long-lasting, water-tight pan is positioned below the indoor coil to collect and drain all condensate, preventing build-up of stagnant condensate. The condensate pan conforms to ASHRAE 62-89 standards (Ventilation for Acceptable Indoor Air Quality).
- **Condensate Drain** - The 3/4-in. NPT female connection is rigidly mounted to ensure proper fit and leak tight seal.
- **Durable Finish** - The cabinet is made of G90 galvanized steel with a powder paint coating for appearance and protection. The pre-treated galvanized steel provides a better paint-to-steel bond, which resists corrosion and rust creep. Powder paint finish ensures less fading when exposed to sunlight, and provides superior corrosion resistance (1,000 hour salt spray tested).

Continued on next page.

- **Full Perimeter Base Rails** - The easily removable base rails provide a solid foundation for the entire unit and protect the unit during shipment. The rails provide fork lift access from all sides, and rigging holes are also provided so that an overhead crane can be used to place the units on a roof. On applications where the unit is placed on a pad, the base keeps the unit off the pad to deter corrosion. On applications where height is limited, the base rails may be removed by removing two screws in each corner.
- **More Attractive Appearance** - A single-piece top cover containing a top-discharge outdoor fan arrangement requires less square footage on installation and provides a wider variety of installations. The one-piece design adds greater water integrity. Rounded corners with water drip edges add to the attractive appearance.
- **Top Discharge** - The top-discharge outdoor fan does not disrupt neighboring areas or dry out vegetation surrounding the unit. The warm air from the top mounted fan is blown up and away from the structure and any landscaping. This allows compact location on multi-unit applications.
- **Outdoor Coil Grille** - All models utilize a stamped slotted design that provides superior impact protection against small objects during transit and after installation.
- **Low Operating Sound Level** - The upward airflow carries the normal operating noise up and away from the living area. The rigid top panel effectively isolates noise. Isolator mounted compressor and the rippled fins of the outdoor coil muffle the normal fan motor and compressor operating sounds. The uniquely formed base pan also aids in sound attenuation with its structural design. This design strategically places embossments in the pan for optimum strength and rigidity.
- **Fan System** - All models operate over a wide range of design conditions with an enhanced ECM indoor blower motor. These units easily match all types of applications and provide greater on-site flexibility to match comfort requirements. The cooling speed is factory-set and can be field-adjusted to a second speed. The heating speed is factory set to maintain mid point rise at the units heating input, but can be field adjusted. This allows for maximum comfort conditions.
- **Simple Control Circuit** - A low voltage gas heat printed circuit board contains a status/diagnostic indicator light. Field thermostat wiring connects to color coded leads using twist on wire connections. Cooling controls use contactor and relays for simple application and troubleshooting. MATE-N-LOK® plug connectors are used. The electrical control box is not located in the compressor compartment. The controls are mounted to allow the separate access panel to be removed for troubleshooting and maintenance without affecting the normal system operating pressures. All wiring internal to the unit is color/number coded.
- **Protected Compressor** - The compressor is internally protected against high pressure and temperature. This is accomplished by the simultaneous operation of scroll bypass and a temperature sensor, which protects the compressor if undesirable operating conditions occur. The crankcase heater ensures lubrication of the compressor at start-up by mitigating the impact of refrigerant migration and condensation when the system is off, keeping the refrigerant at a temperature higher than the coldest part of the system.
- **Pressure Switches** - A high pressure switch is standard in all units. It is an automatic reset switch. When discharge pressure reaches 650 psi, the compressor de-energizes until pressure reaches 450 psi.
- **Exclusive Coil Design** - The grooved copper tubes and enhanced aluminum fin construction of the outdoor coils improve heat transfer for maximum efficiency and durability. Indoor tube and fin coils have all aluminum construction for reliability and efficient heat transfer.
- **Heat Exchangers** - Gas heat exchangers use corrosion-resistant, stainless-steel tubular construction to provide long-life, trouble-free operation. Gas heat exchangers are offered with lifetime warranties as standard with registration.
- **Post-Purge Induced Draft Combustion** - Exhausts combustion products from the heat exchanger upon completion of the heating cycle to prolong the heat exchanger life.
- **Spark to Burner Ignition** - No pilot assembly required, which provides more consistent ignition in gas heating mode. This ignition is highly reliable, durable, and eliminates nuisance lockouts.
- **Multi Port In-Shot Burners** - No field adjustment is required to mix the air and gas for natural gas or propane use. These burners are constructed of high-grade corrosion-resistant, aluminized steel.
- **Low Maintenance** - Long-life, permanently lubricated outdoor fan motor bearings and indoor blower motor bearings need no annual maintenance, adding greater reliability to the unit. Slide-out blower assembly can be easily removed for cleaning.
- **Easy Service Access** - Individual access panels covering the electrical and gas controls make servicing easy. Removing these panels allows easy removal of components such as the blower assembly for maintenance and troubleshooting.
- **Replacement Parts** - The installer requires no special training to replace any of the components of these units and the number of new components has been reduced to minimize the inventory of unique parts.
- **Loss of Charge Switch** - All models include a loss of charge switch to provide safe shutdown of compressor.

NOMENCLATURE

PCG	6	A	24	050	2	X	4	A
1	2	3	4	5	6	7	8	9
1. Model Family PCG - packaged A/C with gas heat PHG - packaged heat pump with gas heat PCE - packaged A/C with electric heat PHE - packaged heat pump with electric heat 2. Nominal Cooling Efficiency 4 = 14 SEER, 6 = 16 SEER 3. Cabinet Size A = small 35.75 x 51.25, B = large 45.75 x 51.25 4. Nominal Air Conditioning Cooling Capacity BTU/h x 1000 24 = 24,000 BTU/h, 30 = 30,000 BTU/h Example: PCG6A240502X4A is a packaged A/C with gas heat, 16 SEER, small cabinet, 2 ton, two-stage heat, 50,000 BTU/h gas heat, 208/230 V, single-phase, Low NOx model, fourth generation, original release.					5. Gas Heating Input BTU/h x 1000 050 = 50,000 BTU/h input, blank = electric heat 6. Voltage-Phase-Frequency 2 = 208/230-1-60, 3 = 208/230-3-60, 4 = 460-3-60 7. NOx Approval X = Low NOx, blank = not Low NOx 8. Generation Level 1 = first generation, 2 = second generation 9. Revision Level A = original release, B = second release			

COMPONENT LOCATION

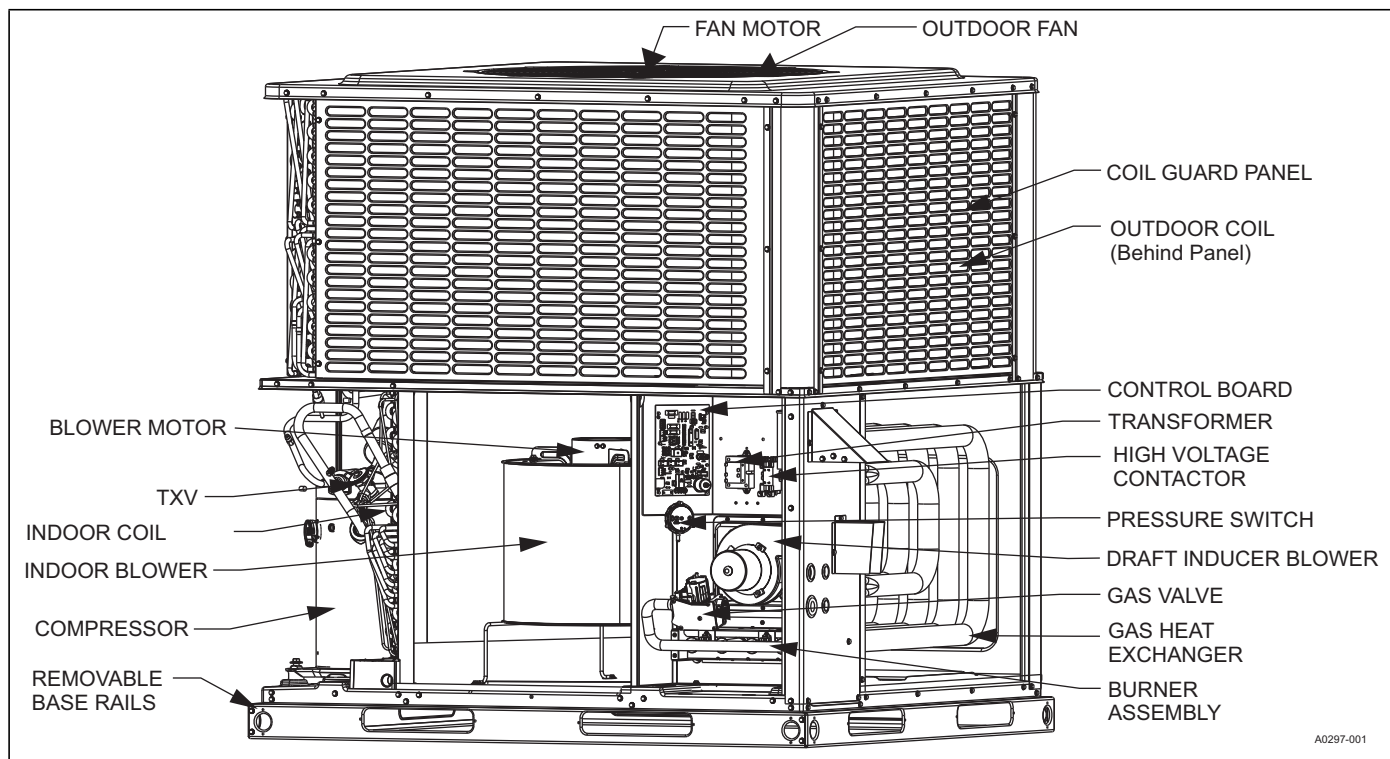

UNIT LIMITATIONS

Model	Unit Voltage	Unit Limitations		
		Applied Voltage		Outdoor DB Temperature Maximum (°F)
		Minimum	Maximum	
PCG6A24	208/230-1-60	187	252	125
PCG6A36	208/230-1-60	187	252	125
PCG6B48	208/230-1-60	187	252	125
PCG6B60	208/230-1-60	187	252	125

APPLICATIONS AND ACCESSORIES

Application Limitations				
Packaged Equipment Series	Air Temperature at Outdoor Coil (°F)		Air Temperature at Indoor Coil (°F)	
	Minimum	Maximum	Minimum	Maximum
	DB Cool	DB Cool	WB Cool	WB Cool
16 SEER AC	55	125	57	72

- **Anchor Bracket Kit (S1-1HK0601)** - This kit firmly anchors PCG, PCE, PHE, and PHG packaged units to a pad or support structure. When correctly installed, the kit is approved for ground-mounted or roof-mounted applications, wind load certified, and listed with the State of Florida. See <https://floridabuilding.org> for this listing.
- **Flue Exhaust Extension Kit (S1-1FE0422, S1-1FE0417)** - The purpose of this kit is to divert flue gas up and away from walkways or fresh air intakes. Use the kit when installing PCG or PHG packaged units if required.
- **Propane Conversion Kit (S1-1NP0703, S1-1NP0704)** - Kit includes burner orifices, gas valve conversion and installation instructions necessary to field convert unit from natural gas to propane.
- **Economizer for Downflow Applications (S1-2EE04710024, S1-2EE04710124)** - Modulating integrated economizer provides simultaneous operation between the mechanical cooling and economizer operation. Independent blade design ensures proper control and less than 1% leak rate. Includes hood and mesh bird screen filter integrated into the hood, dry bulb sensor, and barometric relief damper. Separate field accessories of single enthalpy and dual enthalpy are also available.
- **Economizer for Horizontal Applications (S1-2EE04710224, S1-2EE04710324)** - Modulating integrated economizer provides simultaneous operation between the mechanical cooling and economizer operation. Independent blade design ensures proper control and less than 1% leak rate. Includes hood and mesh bird screen filter integrated into the hood and dry bulb sensor. Separate field accessories of single enthalpy and dual enthalpy are also available.
- **Barometric Relief Hood (S1-1RD0501)** - Used in conjunction with a horizontal economizer, the Barometric Relief Hood helps to equalize the building pressure caused by the fresh air introduced through the economizer fresh air hood.
- **Single/Dual Enthalpy Sensor (S1-HE-69630NS-2D)** - This sensor replaces the supply air temperature dry bulb sensor standard in the economizer kit. The sensor enables improved economizer operation by sensing the dry bulb temperature of indoor supply air plus the enthalpy content of the outdoor air.
- **Duct/Unit Mount CO2 Kit (S1-2AQ04700924)** - Sensor kit detects CO2 levels automatically and overrides the economizer when CO2 levels rise above the preset limits.
- **Wall Mount CO2 Kit (S1-2AQ04701024)** - Sensor kit detects CO2 levels automatically and overrides the economizer when CO2 levels rise above the preset limits.
- **Supply Air Temperature Sensor Kit (S1-TE-63616E-2D)** - Outdoor supply air temperature sensor kit used with economizers.
- **Filter/Frame Kit (S1-1FF0602, S1-1FF0601)** - Kit contains the necessary hardware to field install return air filters into the base unit. The filter rack is suitable for either 1 in. filters or 2-in. filters.
- **Filter (S1-02647812000)** - Washable 1-in. filter. Two filters are required for A base units. Three filters are required for B base units.
- **Motorized Fresh Air Damper (S1-2MD04705224, S1-2MD04705124)** - Designed for duct mounted side supply/return and unit mounted down supply/return applications. Damper capable of providing 0% through 50% of outdoor air (field supplied). Closes on power loss, includes hood and screen assembly.
- **Rectangle to Round (Horizontal) Adapter (S1-1AK0110, S1-1AK0111)** - Kit includes one supply and one return air rectangle to round duct adapter. Adapters are preformed and designed to fit over current horizontal duct openings on the base unit. Transition is from rectangle to 12 in. round for the 1AK0110 kit and from rectangle to 14 in. round for the 1AK0111 kit.
- **Rectangle to Round (Downflow) Adapter (S1-1AK0108, S1-1AK0109)** - Kit includes one supply and one return air rectangle to round duct adapter. Adapters are preformed and designed to fit into current downflow duct openings on the roof curb. Transition is from rectangle to 16 in. round for the 1AK0108 kit and from rectangle to 18 in. round for the 1AK0109 kit.
- **Roof Curbs (S1-1RC0503, S1-1RC0501)** - NRCA approved curbs provide proper fit to base unit for rooftop installations. Curbs are designed to be assembled through hinge pins in each corner. Kit also provides seal strip to assure an air tight seal. These are 8-in. high roof curbs.
- **Roof Curbs (S1-1RC0504, S1-1RC0502)** - NRCA approved curbs provide proper fit to base unit for rooftop installations. Curbs are designed to be assembled through hinge pins in each corner. Kit also provides seal strip to assure an air tight seal. These are 14-in. high roof curbs.
- **Transition Curb Kits (S1-1TC01*)** - These adapter kits allow use of existing field-installed roof curbs, matching the PCG6 unit footprint to Affinity roof curbs or Carrier, Trane, or Goodman roof curbs. Curb adapters are optional for current generation Carrier replacements, but are recommended for previous generation applications. Refer to the PCG6 price pages for more details.
- **Manual Outdoor Damper (S1-1FA0502, S1-1FA0501)** - Provides 0% through 50% outdoor air capability (field adjustable). Designed for duct mounted side supply/return applications. Includes hood and screen assembly.
- **Thermostat** - Compatible thermostat controls are available through accessory sourcing. For optimum performance, these outdoor units are fully compatible with our residential Hx™ Touch Screen Thermostat available through Source 1. For more information, refer to the *Thermostats & Controllers* section of the *Offering Catalog*.
- **Wall Thermostat** - The units are designed to operate with standard, 24-V electronic and electromechanical thermostats. All units can operate with a single stage heat thermostat, but require a multistage thermostat for cooling.
- **Low Ambient Kit (S1-2LA04701024)** - Kit provides necessary hardware to convert unit to operate in cooling cycle down to 0°F. Standard unit operation is 55°F.
- **Transformer Kit (S1-2EC06700124)** - This kit provides the necessary hardware to change single-phase models from the factory with 40-VA transformer capability to 75-VA transformer capability. Required on installations with an economizer or motorized damper.
- **Base Rail Hole Cover Kit (S1-1HC0101)** - Kit provides necessary hardware to close off openings in base rails to block off openings and prevent animal entrance.

GUIDE SPECIFICATIONS

GENERAL

Units shall be manufactured by Ducted Systems in an ISO 9001 certified facility. Package units give you the flexibility and choices you need in today's market. These packaged cooling/heating air conditioners are designed for outdoor installation. Only utility and duct connections are required at the point of installation. The single-stage gas fired heaters have stainless steel tubular heat exchangers and spark to burner ignition. They are available in natural gas with field conversion to propane.

DESCRIPTION

Units shall be factory-assembled, single packaged, Electric Cooling/Gas Heating units, designed for outdoor installation. For SEER ratings, refer to technical literature. They shall have built in, equal size, field convertible duct connections for supply/return or horizontal supply/return. The units shall be factory wired, piped, charged with R-410A refrigerant, and factory tested prior to shipment. All unit wiring shall be both numbered and color coded. All models shall be rated in accordance with DOE and AHRI test procedures for both heating and cooling operation. Units shall be CSA listed and classified to ANSI Z21.47/CAN/ CSA 2.3 standards and UL 1995/CAN/CSA No. 236-M90 standards.

UNIT CABINET

Unit cabinet shall be constructed of G-90 galvanized, powder-painted steel, certified at 1,000 hours salt spray test per ASTM-B117 standards. The unit top shall be a single piece design, with drip edges and no-seam corners to provide optimum water integrity. Unit shall have a rigidly mounted outdoor coil guard to provide protection from objects and personnel after installation. Indoor blower section shall be insulated with foil-faced or foam insulation, fastened to prevent insulation from entering the air stream. Cabinet panels shall be separate and easily removable for servicing and maintenance. Unit shall be built on a formed, design base pan, with embossments at critical points to add strength and rigidity and to aid in minimizing sound. Full perimeter base rails shall be provided to ensure reliable transit of equipment and facilitate overhead rigging, allowing truck access and proper sealing on roof curb applications. Base rails shall be easily removable, when required to lower unit height. Filters shall be field installed, furnished, and accessible through a removable access door, sealed airtight. The unit's vertical discharge and return duct configuration shall be designed to fit between standard 24-in. O.C. beams without modification to building structure, duct work, and base unit. Condensate pan shall be internally sloped and conform to ASHRAE 62-89 self-draining standards, with 3/4-in. NPT female ridged mount connection.

Indoor Blower Assembly - Blower shall be direct drive design. Blower wheel shall be double-inlet type with forward-curved blades, dynamically balanced to operate smoothly throughout the entire range of operation. Airflow design shall be constant air volume. Bearings shall be sealed and permanently lubricated for longer life and no maintenance. Blower assembly shall be a slide-out design for easy removal and cleaning. Indoor blower motors shall be equipped with a standard high efficiency brushless DC motor (constant torque), also known as an enhanced ECM motor.

Outdoor Fan Assembly - The outdoor fan shall be of the direct-driven propeller type, discharge air vertically, have aluminum blades riveted to corrosion resistant steel spider bracket and shall be statically balanced for smooth operation. The outdoor fan motor shall be totally enclosed with permanently lubricated bearings and internally protected against overload conditions.

REFRIGERANT COMPONENTS

Compressors:

- Shall be fully hermetic type, direct drive, internally protected with internal high-pressure relief and over temperature protection. The hermetic motor shall be suction gas cooled and have a voltage range of +/- 10% of the unit nameplate voltage.
- Shall have internal isolation and sound muffling to minimize vibration and noise, and be externally isolated on a dedicated, independent mounting.

Coils:

- Indoor coils shall have aluminum plate fins mechanically bonded to seamless internally enhanced aluminum tubes with all joints brazed.
- Indoor coil shall be of the direct expansion, draw through design.
- Outdoor coils shall have aluminum plate fins mechanically bonded to seamless internally enhanced copper tubes with all joints brazed.
- Outdoor coil shall be draw through design.

Refrigerant Circuit and Refrigerant Safety Components shall include:

- Thermal expansion valve (TXV) that shall be factory mounted and provided
- Filter/strainer to eliminate any foreign matter

GAS HEATING SECTION (If Equipped)

Heat exchanger and exhaust system shall be constructed of corrosion-resistant materials and shall be designed with induced draft combustion with post-purge logic and redundant main gas valve. The heat exchanger shall be of the tubular type, constructed of stainless steel for corrosion resistance and allowing minimum mixed air entering temperature of 40°F. Burners shall be of the in-shot type, constructed of aluminumized steel. All gas piping shall enter the unit cabinet at a single location through either the side or bottom, without any field modifications. An integrated control board shall provide timed control of indoor blower functioning and burner ignition. The heating section shall be provided with the following minimum protection:

- Primary high-temperature limit switch
- Induced draft pressure switch
- Flame roll out switch or switches (manual reset)
- Flame proving controls

All gas heat models meet the California requirement for emissions of less than 40 ng/J (California requirement on single-phase models only).

PHYSICAL DATA

MODELS:	PCG6A24		PCG6A36		PCG6B48			PCG6B60		
NOMINAL TONNAGE:	2.0		3.0		4.0			5.0		
AHRI Cooling Performance										
Gross Capacity at AHRI A point (MBH)	24.3		36.7		47.1			60.8		
AHRI net capacity (MBH)	24.0		35.8		46.0			59.0		
EER	12.5		12.0		12.0			12.0		
SEER	16.0		16.0		16.0			16.0		
Nominal CFM	750		1200		1550			1825		
System power (kW)	1.9		3.0		3.8			4.9		
Refrigerant type	R-410A		R-410A		R-410A			R-410A		
Refrigerant charge (lb-oz)	4-3		7-2		7-14			10-2		
AHRI Gas Heat Performance										
Heating model	50	75	75	100	65	100	125	65	100	125
Heat input - High Fire (KBTU)	50	75	75	100	65	100	125	65	100	125
Heat output - High Fire (KBTU)	40	60	60	80	52	80	101	52	80	101
Heat input - Low Fire (KBTU)	33	49	49	65	43	65	82	43	65	82
Heat output - Low Fire (KBTU)	26	39	39	53	34	53	66	34	53	66
AFUE %	81.0	81.0	81.0	81.0	81.0	81.0	81.0	81.0	81.0	81.0
No. of burners	2	3	3	4	2	3	4	2	3	4
No. of stages	2	2	2	2	2	2	2	2	2	2
Temperature rise range - High Fire (°F)	40-70		40-70		40-70			40-70		
Temperature rise range - Low Fire (°F)	20-50		20-50	25-55	25-55			25-55		
Maximum static pressure W.C.	0.5		0.5		0.5			0.5		
Maximum outlet air temperature (°F)	180		180		180			180		
Gas piping connection (in.)	1/2		1/2		1/2			1/2		
Dimensions (in.)										
Length	51 1/4		51 1/4		51 1/4			51 1/4		
Width	35 3/4		35 3/4		45 3/4			45 3/4		
Height	44		47		47			50		
Compressor										
Type	Scroll		Scroll		Scroll			Scroll		
Stages	2		2		2			2		
Outdoor Coil Data										
Face area (ft ²)	12.3		15.3		17.5			21.1		
Rows	1		2		2			2		
Fins per inch	22		22		22			22		
Tube diameter (mm)	7		7		7			7		
Circuitry type	Straight		Interlaced		Interlaced			Interlaced		
Indoor Coil Data										
Face area (ft ²)	4.6		4.6		6.2			6.2		
Rows	2		3		3			4		
Fins per inch	16		16		16			16		
Tube diameter (in.)	3/8		3/8		3/8			3/8		
Circuitry type	Interlaced		Interlaced		Interlaced			Interlaced		
Refrigerant control	TXV		TXV		TXV			TXV		
Outdoor Fan Data										
Fan diameter (in.)	24		24		26			26		
Type	Prop		Prop		Prop			Prop		
Drive type	Direct		Direct		Direct			Direct		
No. of speeds	1		1		1			1		
Motor HP each	1/8		1/3		1/3			1/3		
RPM	790		850		850			850		
Nominal total CFM	2400		2400		3200			3200		
Direct Drive Evaporator Blower Data										
Blower size (in.)	11 x 8		11 x 10		11 x 10			11 x 10		
Type	Centrifugal		Centrifugal		Centrifugal			Centrifugal		
Motor HP each	1/3	1/2	1/2	3/4	3/4			1		
RPM	1400 Maximum		1400 Maximum		1400 Maximum			1400 Maximum		
Frame size	48		48		48			48		
Filters										
Filter size	A		A		B			B		
Quantity - size	Field-supplied external filters must be sized so as not to exceed 300 fpm air velocity through disposable filters. For internal filter use, a filter rack kit is available. Consult the instructions supplied with the kit for replacement filter sizes. Filter sizes: A = 20 in. x 20 in., B = 20 in. x 30 in.									

COOLING PERFORMANCE DATA - 4 TON (LOW SPEED)																
PACKAGED UNIT MODEL NO. PCG6B48																
CONDENSER ENTERING AIR TEMPERATURE (°F)	ID CFM	950					1150					1350				
		IDDB	80	80	75	80	80	80	80	75	80	80	80	80	75	80
	IDWB	57	62	62	67	72	57	62	62	67	72	57	62	62	67	72
		T.C.	S.C.	K.W.	T.C.	S.C.	K.W.	T.C.	S.C.	K.W.	T.C.	S.C.	K.W.	T.C.	S.C.	K.W.
55 / 45	T.C.	37.0	40.6	40.0	44.6	49.0	39.6	42.6	41.6	48.4	50.7	42.2	44.6	43.2	52.2	52.4
	S.C.	36.8	34.1	28.9	29.5	24.2	39.0	37.8	31.4	32.5	25.9	41.3	41.4	33.9	35.5	27.5
	K.W.	1.73	1.71	1.72	1.71	1.70	1.79	1.78	1.78	1.78	1.77	1.84	1.84	1.84	1.84	1.83
65 / 55	T.C.	34.5	37.4	36.9	42.1	46.5	37.2	39.3	38.6	44.9	49.6	39.9	41.3	40.2	47.6	52.6
	S.C.	34.1	32.2	27.0	28.3	23.0	36.5	35.6	29.6	31.2	24.9	39.0	39.1	32.2	34.0	26.8
	K.W.	1.91	1.89	1.90	1.88	1.87	1.96	1.96	1.96	1.95	1.94	2.02	2.02	2.02	2.01	2.00
75 / 63	T.C.	32.1	34.3	33.9	39.6	44.1	34.8	36.1	35.5	41.3	48.5	37.5	38.0	37.2	43.0	52.9
	S.C.	31.4	30.2	25.1	27.1	21.7	34.0	33.5	27.8	29.8	24.0	36.7	36.8	30.6	32.5	26.2
	K.W.	2.08	2.07	2.08	2.06	2.04	2.14	2.13	2.14	2.12	2.11	2.20	2.19	2.20	2.18	2.17
85 / 69	T.C.	30.1	31.2	30.9	36.4	40.6	32.6	32.8	32.3	38.0	43.6	35.1	34.5	33.8	39.5	46.6
	S.C.	29.5	28.6	23.4	25.3	20.2	31.9	31.1	26.1	28.0	22.2	34.3	33.6	28.8	30.7	24.3
	K.W.	2.31	2.30	2.30	2.28	2.27	2.37	2.36	2.36	2.35	2.33	2.43	2.42	2.42	2.41	2.39
95 / 75	T.C.	28.2	28.1	28.0	33.2	37.2	30.4	29.6	29.2	34.6	38.7	32.7	31.0	30.4	36.0	40.3
	S.C.	27.6	27.0	21.7	23.6	18.6	29.8	28.7	24.3	26.2	20.5	32.0	30.4	26.9	28.8	22.4
	K.W.	2.53	2.52	2.52	2.51	2.49	2.59	2.58	2.59	2.57	2.55	2.65	2.65	2.65	2.64	2.61
105 / 83	T.C.	25.0	24.7	24.2	29.0	32.7	26.9	26.1	25.3	30.0	33.9	28.9	27.5	26.3	31.1	35.2
	S.C.	24.5	23.9	20.0	21.6	16.8	26.4	25.4	21.9	23.9	18.6	28.2	26.9	23.9	26.2	20.4
	K.W.	2.81	2.80	2.81	2.79	2.78	2.87	2.87	2.87	2.86	2.84	2.93	2.93	2.93	2.92	2.90
115 / 89	T.C.	21.9	21.5	20.6	24.8	28.4	23.6	22.7	21.5	25.6	29.3	25.2	24.0	22.3	26.3	30.2
	S.C.	21.5	20.8	18.3	19.7	15.0	23.1	22.2	19.6	21.7	16.7	24.6	23.5	20.9	23.7	18.4
	K.W.	3.08	3.08	3.08	3.07	3.06	3.14	3.14	3.14	3.13	3.12	3.20	3.20	3.20	3.20	3.19
125 / 95	T.C.	18.9	18.2	17.0	20.7	24.1	20.2	19.4	17.7	21.1	24.7	21.5	20.5	18.3	21.6	25.3
	S.C.	18.5	17.8	16.7	17.7	13.3	19.8	19.0	17.3	19.4	14.9	21.0	20.1	17.9	21.1	16.5
	K.W.	3.35	3.35	3.36	3.34	3.34	3.41	3.41	3.41	3.41	3.41	3.47	3.48	3.47	3.47	3.47

COOLING PERFORMANCE DATA - HIGH - 4 TON (HIGH SPEED)																
PACKAGED UNIT MODEL NO. PCG6B48																
CONDENSER ENTERING AIR TEMPERATURE (°F)	ID CFM	1350					1550					1750				
		IDDB	80	80	75	80	80	80	80	75	80	80	80	80	75	80
	IDWB	57	62	62	67	72	57	62	62	67	72	57	62	62	67	72
		T.C.	S.C.	K.W.	T.C.	S.C.	K.W.	T.C.	S.C.	K.W.	T.C.	S.C.	K.W.	T.C.	S.C.	K.W.
55 / 45	T.C.	49.9	54.5	53.0	59.9	64.4	52.3	56.4	54.9	62.0	66.5	54.7	58.2	56.9	64.1	68.6
	S.C.	49.6	45.6	38.0	39.6	31.5	52.0	48.8	40.5	42.3	33.2	54.3	52.0	43.0	44.9	35.0
	K.W.	2.63	2.66	2.66	2.69	2.75	2.72	2.74	2.74	2.77	2.82	2.81	2.82	2.82	2.85	2.90
65 / 55	T.C.	47.4	50.9	50.0	56.8	61.9	49.5	52.5	51.7	58.6	64.4	51.6	54.2	53.5	60.4	66.8
	S.C.	47.0	43.3	36.4	38.1	30.5	49.1	46.4	38.9	40.6	32.4	51.2	49.5	41.4	43.0	34.3
	K.W.	2.84	2.86	2.86	2.90	2.95	2.93	2.94	2.94	2.98	3.03	3.02	3.02	3.02	3.06	3.11
75 / 63	T.C.	44.8	47.2	47.0	53.6	59.3	46.7	48.7	48.6	55.2	62.2	48.6	50.1	50.1	56.7	65.1
	S.C.	44.4	41.0	34.8	36.5	29.6	46.2	44.0	37.3	38.9	31.6	48.1	47.0	39.8	41.2	33.5
	K.W.	3.05	3.05	3.06	3.11	3.16	3.14	3.13	3.14	3.19	3.24	3.23	3.21	3.22	3.27	3.32
85 / 69	T.C.	42.4	44.1	43.9	50.1	55.4	44.3	45.4	45.2	51.5	57.4	46.2	46.7	46.5	52.9	59.5
	S.C.	42.0	39.5	33.2	34.7	27.7	43.9	42.4	35.5	37.1	29.5	45.7	45.2	37.9	39.4	31.3
	K.W.	3.31	3.32	3.32	3.37	3.41	3.40	3.40	3.40	3.45	3.49	3.49	3.48	3.48	3.53	3.57
95 / 75	T.C.	40.0	41.1	40.9	46.6	51.4	41.9	42.2	41.9	47.8	52.7	43.8	43.4	42.9	49.1	54.0
	S.C.	39.6	38.0	31.6	32.9	25.8	41.5	40.7	33.8	35.2	27.4	43.3	43.2	35.9	37.6	29.1
	K.W.	3.58	3.58	3.58	3.62	3.67	3.66	3.66	3.66	3.70	3.75	3.75	3.74	3.74	3.78	3.83
105 / 83	T.C.	36.8	37.1	36.6	42.1	46.8	38.2	38.2	37.4	43.1	47.8	39.6	39.3	38.1	44.1	48.9
	S.C.	36.4	35.0	29.6	30.8	23.8	37.8	37.1	31.5	33.1	25.4	39.2	39.2	33.4	35.3	27.0
	K.W.	3.96	3.96	3.95	4.00	4.04	4.05	4.04	4.03	4.07	4.12	4.13	4.12	4.11	4.15	4.20
115 / 89	T.C.	33.6	33.3	32.6	37.8	42.3	34.6	34.3	33.0	38.5	43.1	35.6	35.3	33.5	39.3	43.9
	S.C.	33.3	32.0	27.6	28.8	21.9	34.3	33.6	29.3	31.0	23.4	35.3	35.1	31.0	33.1	25.0
	K.W.	4.33	4.32	4.31	4.36	4.39	4.42	4.40	4.39	4.43	4.47	4.50	4.49	4.46	4.51	4.55
125 / 95	T.C.	30.5	29.4	28.5	33.5	37.8	31.1	30.4	28.7	33.9	38.3	31.7	31.4	28.9	34.4	38.9
	S.C.	30.2	29.1	25.7	26.7	19.9	30.8	30.1	27.2	28.9	21.4	31.3	31.0	28.7	31.0	22.9
	K.W.	4.70	4.69	4.67	4.72	4.75	4.79	4.77	4.75	4.80	4.83	4.88	4.85	4.82	4.87	4.91

COOLING PERFORMANCE DATA - 5 TON (LOW SPEED)																
PACKAGED UNIT MODEL NO. PCG6B60																
CONDENSER ENTERING AIR TEMPERATURE (°F)	ID CFM	1150					1350					1550				
	IDDB	80	80	75	80	80	80	80	75	80	80	80	80	75	80	80
	IDWB	57	62	62	67	72	57	62	62	67	72	57	62	62	67	72
55 / 45	T.C.	48.1	53.0	52.4	58.5	63.4	52.5	54.9	54.7	63.1	65.5	56.9	56.7	57.0	67.6	67.6
	S.C.	47.7	44.6	37.8	38.5	31.3	50.8	48.3	41.1	42.0	33.2	53.9	52.0	44.5	45.5	35.2
	K.W.	2.18	2.17	2.19	2.18	2.18	2.25	2.24	2.25	2.24	2.24	2.32	2.31	2.31	2.31	2.31
65 / 55	T.C.	45.6	48.8	48.3	54.5	59.8	49.4	50.6	50.2	58.2	62.8	53.2	52.4	52.1	61.9	65.8
	S.C.	45.0	42.2	35.5	36.5	29.5	48.1	46.0	38.6	39.9	31.6	51.3	49.7	41.6	43.3	33.8
	K.W.	2.41	2.40	2.41	2.40	2.40	2.47	2.47	2.47	2.47	2.46	2.54	2.54	2.54	2.53	2.53
75 / 63	T.C.	43.1	44.5	44.2	50.4	56.2	46.4	46.3	45.7	53.3	60.1	49.6	48.2	47.2	56.1	63.9
	S.C.	42.2	39.9	33.2	34.5	27.7	45.4	43.6	36.0	37.7	30.0	48.6	47.3	38.8	41.0	32.3
	K.W.	2.64	2.63	2.63	2.63	2.61	2.70	2.70	2.70	2.69	2.68	2.76	2.76	2.77	2.76	2.75
85 / 69	T.C.	40.4	41.5	40.6	47.0	51.9	43.2	43.3	41.9	49.2	54.7	46.0	45.2	43.2	51.3	57.5
	S.C.	39.0	37.7	31.2	32.6	25.7	42.1	40.7	34.1	35.7	27.8	45.2	43.6	37.0	38.9	30.0
	K.W.	2.93	2.92	2.92	2.92	2.91	2.99	2.99	2.99	2.99	2.98	3.06	3.06	3.06	3.05	3.04
95 / 75	T.C.	37.7	38.5	36.9	43.5	47.7	40.0	40.3	38.1	45.0	49.3	42.3	42.2	39.3	46.6	51.0
	S.C.	35.8	35.5	29.1	30.7	23.7	38.8	37.7	32.2	33.7	25.7	41.8	39.9	35.3	36.7	27.7
	K.W.	3.22	3.22	3.22	3.21	3.20	3.29	3.29	3.28	3.28	3.27	3.35	3.36	3.35	3.35	3.34
105 / 83	T.C.	33.4	33.3	31.5	37.4	41.7	35.2	34.8	32.5	38.5	42.9	37.0	36.4	33.4	39.5	44.1
	S.C.	32.1	31.2	26.3	28.1	21.4	34.3	32.8	28.3	30.3	23.2	36.5	34.4	30.4	32.6	25.1
	K.W.	3.60	3.59	3.59	3.59	3.58	3.66	3.66	3.65	3.66	3.65	3.73	3.73	3.72	3.73	3.72
115 / 89	T.C.	29.2	28.2	26.2	31.5	36.0	30.5	29.5	27.0	32.1	36.7	31.8	30.8	27.7	32.7	37.4
	S.C.	28.4	27.0	23.5	25.5	19.1	29.9	28.1	24.6	27.0	20.9	31.4	29.1	25.6	28.5	22.6
	K.W.	3.96	3.95	3.94	3.95	3.95	4.02	4.01	4.01	4.02	4.02	4.09	4.08	4.08	4.09	4.09
125 / 95	T.C.	25.1	23.1	21.0	25.6	30.3	25.8	24.2	21.5	25.7	30.5	26.6	25.2	22.0	25.9	30.8
	S.C.	24.8	22.8	20.7	22.9	16.9	25.5	23.3	20.8	23.7	18.5	26.3	23.8	20.8	24.5	20.0
	K.W.	4.32	4.30	4.30	4.31	4.32	4.38	4.37	4.37	4.38	4.39	4.45	4.44	4.43	4.45	4.46

COOLING PERFORMANCE DATA - 5 TON (HIGH SPEED)																
PACKAGED UNIT MODEL NO. PCG6B60																
CONDENSER ENTERING AIR TEMPERATURE (°F)	ID CFM	1600					1800					2000				
	IDDB	80	80	75	80	80	80	80	75	80	80	80	80	75	80	80
	IDWB	57	62	62	67	72	57	62	62	67	72	57	62	62	67	72
55 / 45	T.C.	63.4	66.7	66.4	71.6	81.6	66.2	68.6	68.7	73.7	91.8	69.1	70.5	70.9	75.8	102.1
	S.C.	62.4	56.1	48.9	47.7	40.1	64.9	59.6	52.2	50.1	42.5	67.4	63.0	55.4	52.4	44.8
	K.W.	3.39	3.44	3.43	3.51	3.33	3.50	3.53	3.52	3.60	3.41	3.60	3.62	3.60	3.69	3.49
65 / 55	T.C.	59.7	63.0	62.7	69.3	79.9	62.4	65.0	64.8	72.3	90.1	65.2	67.0	66.9	75.4	100.3
	S.C.	59.0	54.8	46.9	47.1	39.6	61.6	58.2	50.1	49.8	42.0	64.2	61.7	53.2	52.6	44.3
	K.W.	3.66	3.69	3.69	3.77	3.72	3.76	3.78	3.78	3.86	3.80	3.87	3.88	3.86	3.94	3.89
75 / 63	T.C.	55.9	59.3	58.9	66.9	78.2	58.6	61.4	60.9	70.9	88.4	61.3	63.5	62.8	74.9	98.5
	S.C.	55.6	53.6	45.0	46.4	39.1	58.3	56.9	48.0	49.6	41.5	61.0	60.3	51.1	52.7	43.8
	K.W.	3.92	3.94	3.95	4.02	4.11	4.03	4.04	4.04	4.11	4.19	4.13	4.14	4.13	4.20	4.28
85 / 69	T.C.	53.5	56.0	55.5	63.2	71.9	55.8	57.9	56.9	65.9	78.0	58.1	59.9	58.4	68.7	84.1
	S.C.	53.3	51.0	42.9	44.2	36.2	55.5	54.1	45.6	47.2	38.4	57.7	57.2	48.4	50.2	40.5
	K.W.	4.28	4.28	4.29	4.36	4.44	4.38	4.38	4.38	4.45	4.53	4.48	4.48	4.47	4.54	4.63
95 / 75	T.C.	51.1	52.7	52.0	59.4	65.6	53.0	54.5	53.0	60.9	67.6	54.8	56.3	54.0	62.5	69.6
	S.C.	51.0	48.3	40.8	42.0	33.3	52.7	51.2	43.3	44.8	35.3	54.4	54.2	45.7	47.6	37.2
	K.W.	4.64	4.63	4.64	4.70	4.78	4.73	4.73	4.72	4.79	4.88	4.83	4.82	4.81	4.88	4.97
105 / 83	T.C.	49.4	48.1	47.2	53.8	59.7	51.1	49.7	46.7	55.1	61.3	52.8	51.2	46.2	56.3	62.9
	S.C.	49.3	45.1	38.2	39.6	30.9	50.9	47.5	39.5	42.2	32.8	52.5	49.9	40.7	44.9	34.6
	K.W.	4.91	5.15	5.15	5.21	5.29	5.00	5.24	5.23	5.30	5.38	5.09	5.34	5.32	5.39	5.47
115 / 89	T.C.	47.6	43.7	42.6	48.5	54.0	49.2	45.0	40.7	49.4	55.3	50.8	46.4	38.7	50.3	56.5
	S.C.	47.2	41.9	35.7	37.2	28.5	49.2	43.8	35.8	39.8	30.3	50.7	45.8	35.9	42.3	32.1
	K.W.	5.16	5.65	5.64	5.70	5.78	5.25	5.74	5.73	5.79	5.87	5.34	5.84	5.82	5.88	5.96
125 / 95	T.C.	45.9	39.2	38.0	43.1	48.4	47.4	40.4	34.6	43.7	49.2	48.8	41.5	31.2	44.3	50.0
	S.C.	45.6	38.7	33.3	34.9	26.1	47.4	40.2	32.1	37.3	27.9	48.8	41.2	31.0	39.6	29.6
	K.W.	5.42	6.15	6.14	6.20	6.27	5.51	6.24	6.23	6.28	6.36	5.59	6.34	6.32	6.37	6.44

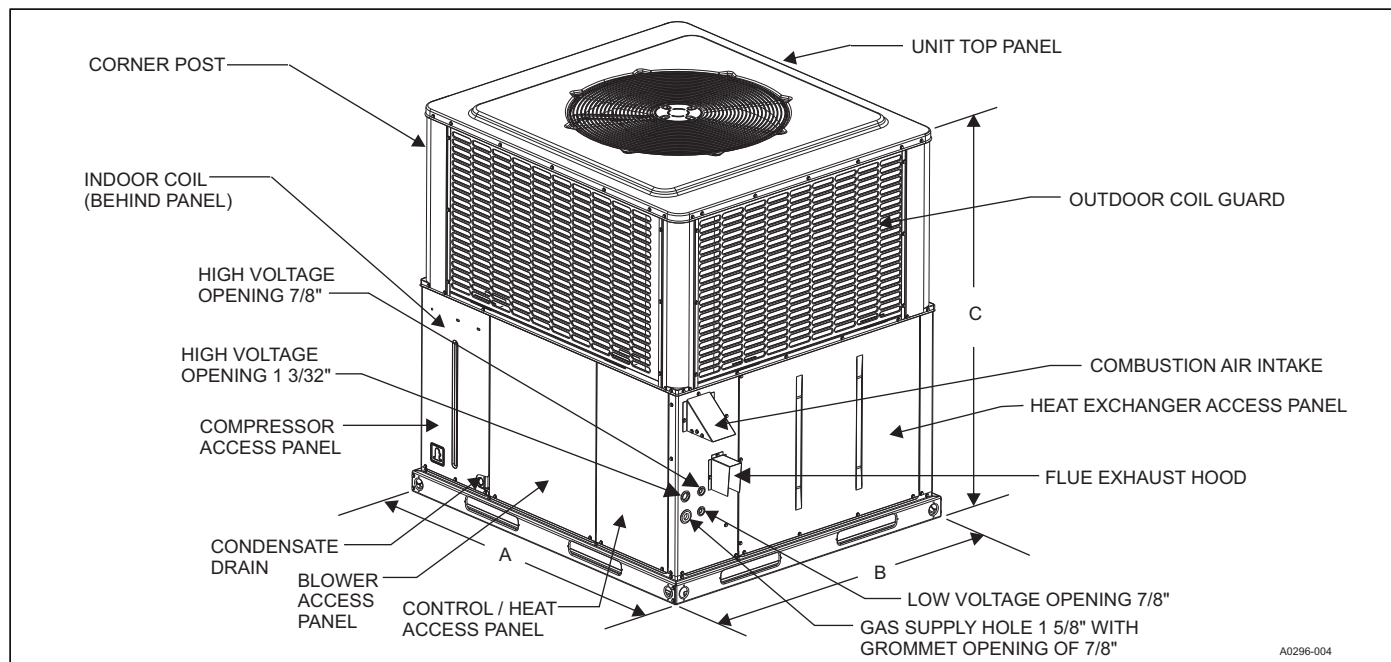

A0296-004

UNIT DIMENSIONS

Model	Dimensions (in.)		
	A	B	C
PCG6A24	51 1/4	35 3/4	44
PCG6A36	51 1/4	35 3/4	47
PCG6B48	51 1/4	45 3/4	47
PCG6B60	51 1/4	45 3/4	50

UNIT CLEARANCES^{1,2,4}

Direction	Distance (in.)	Direction	Distance (in.)
Top ³	36	Power Entry (Right Side)	36
Side Opposite Ducts	36	Left Side	24
Duct Panel	0	Bottom ⁴	1

1. A 1-in. clearance must be provided between any combustible material and the supply air duct work.
2. The products of combustion must not be allowed to accumulate within a confined space and recirculate.
3. Units must be installed outdoors. Overhanging structures or shrubs must not obstruct the outdoor air discharge outlet.
4. Units can be installed on combustible materials made from wood or class A, B or C roof covering materials if factory base rails are left in place as shipped.

INDOOR BLOWER SPECIFICATIONS - PCG6

Model	Motor				
	HP	RPM	EFF.	SF	Frame
24050	1/3	Variable	0.8	1.0	48
24075, 36075	1/2	Variable	0.8	1.0	48
36100, 48065, 48100, 48125	3/4	Variable	0.8	1.0	48
60065, 60100, 60125	1	Variable	0.8	1.0	48

SOUND PERFORMANCE

Model (Tons)	Sound Rating ¹ dB(A)	Octave Band Centerline Frequency (Hz)						
		125	250	500	1000	2000	4000	8000
PCG6A24	71	75.4	69.0	68.7	66	62	59.0	55.1
PCG6A36	75	73.8	73.1	73.3	71.0	66.1	61.0	54.9
PCG6B48	73	77.3	73.1	69.4	69	63	60.8	53.5
PCG6B60	75	79.5	72.1	68.9	72	66	63.5	60.9

1. Rated in accordance with AHRI Standard 270.

ELECTRICAL DATA - PCG6

Model	Voltage	Compressor			OD Fan Motor	Indoor Blower Motor	MCA ¹ (A)	Max Fuse ² / Breaker ³ Size (A)
		RLA	LRA	MCC	FLA	FLA		
24050	208/230-1-60	10.2	55.2	15.9	0.8	2.6	16.1	25
24075	208/230-1-60	10.2	55.2	15.9	0.8	3.8	17.3	25
36075	208/230-1-60	14.2	78.1	22.1	1.7	3.8	23.2	35
36100	208/230-1-60	14.2	78.1	22.1	1.7	5.4	24.8	35
48065, 48100, 48125	208/230-1-60	17.1	109.0	26.6	1.7	5.4	28.4	45
60065, 60100, 60125	208/230-1-60	23.5	118.0	36.6	1.7	7.0	38.0	60

1. Minimum Circuit Ampacity.
2. Maximum Over Current Protection per standard UL 1995.
3. Fuse or HACR circuit breaker is field installed.

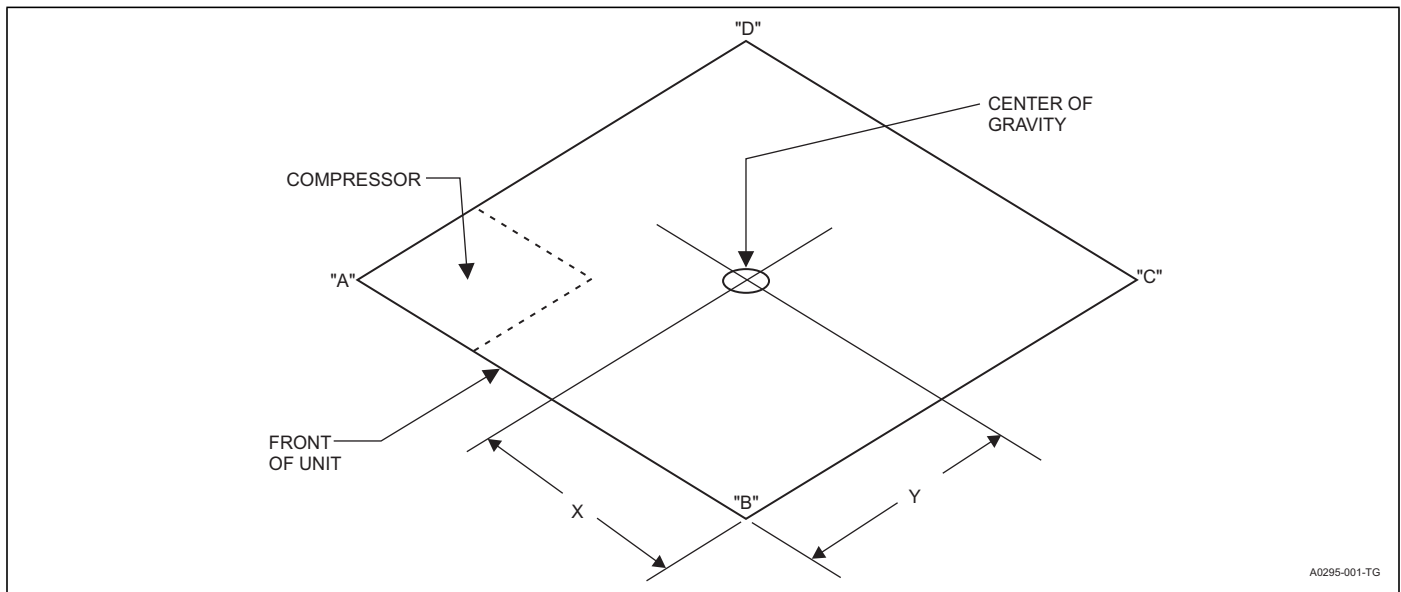

WEIGHTS AND DIMENSIONS

Model	Weight (lb)		Center of Gravity		4-Point Load Location (lb)			
	Shipping	Operating	X	Y	A	B	C	D
PCG6A240502X4	372	367	28	15	120	95	81	71
PCG6A240752X4	382	377	28	15	124	96	81	76
PCG6A360752X4	466	461	28	15	161	113	96	91
PCG6A361002X4	473	468	28	15	163	114	101	90
PCG6B480652X4	520	515	28	15	189	116	93	117
PCG6B481002X4	528	523	28	15	169	139	115	100
PCG6B481252X4	533	528	28	15	164	145	124	95
PCG6B600652X4	537	532	29	15	174	142	124	92
PCG6B601002X4	541	536	28	15	177	140	117	102
PCG6B601252X4	548	543	27	15	151	167	141	84

AIRFLOW PERFORMANCE - SIDE DUCT APPLICATION

Model	Jumper Position	External Static Pressure (in. W.C.)										
		0.1	0.2	0.3	0.4	0.5	0.6	0.7	0.8	0.9	1.0	
		SCFM	SCFM	SCFM	SCFM	SCFM	SCFM	SCFM	SCFM	SCFM	SCFM	
PCG6A24050	High Cool	A	900	870	830	800	750	690	660	610	570	530
		B	850	810	770	730	680	630	590	550	500	460
		C	760	730	690	640	580	540	490	450	400	350
		D	680	640	600	550	490	440	390	350	300	250
	Low Cool	A	710	670	620	570	510	470	420	380	330	280
		B	590	560	510	450	400	350	300	250	190	150
		C	550	510	470	410	370	310	270	210	160	120
		D	490	460	420	360	330	280	240	190	140	100
	High Heat	A	890	860	820	790	740	680	650	600	560	520
		B	800	760	720	680	620	580	530	490	440	400
		C	720	680	640	590	530	480	430	390	340	290
		D	690	650	610	560	500	450	400	360	310	260
	Low Heat	A	890	860	820	790	740	680	650	600	560	520
		B	790	750	710	660	600	570	520	480	430	380
		C	670	630	590	530	480	430	380	330	280	230
		D	640	610	560	500	450	400	350	310	250	210
PCG6A24075	High Cool	A	840	800	770	730	680	630	590	530	490	450
		B	770	730	700	650	600	530	490	440	400	360
		C	640	600	560	500	450	400	350	300	240	200
		D	580	550	500	440	390	350	290	240	180	130
	Low Cool	A	580	550	500	440	390	350	290	240	180	130
		B	290	270	250	220	200	170	150	120	90	60
		C	290	270	250	220	200	170	150	120	90	60
		D	290	270	250	220	200	170	150	120	90	60
	High Heat	A	1170	1140	1110	1080	1050	1030	990	960	920	890
		B	1060	1030	1000	970	940	900	870	830	790	730
		C	960	930	900	860	830	790	750	690	650	600
		D	870	830	800	760	720	670	620	570	520	490
	Low Heat	A	1180	1160	1130	1100	1070	1050	1010	980	940	910
		B	1060	1030	1000	970	940	900	870	830	790	730
		C	960	930	900	860	830	790	750	690	650	600
		D	820	790	750	710	670	610	570	510	470	430
PCG6A36075	High Cool	A	1280	1240	1200	1160	1120	1070	1020	970	920	870
		B	1180	1140	1090	1050	1000	940	890	850	800	750
		C	1010	970	920	860	800	750	700	660	610	570
		D	940	890	840	770	720	670	620	570	530	480
	Low Cool	A	940	890	840	770	720	670	620	570	530	480
		B	860	810	730	680	630	580	530	470	420	370
		C	800	740	650	600	550	500	450	390	330	280
		D	710	640	560	510	450	390	340	260	190	130
	High Heat	A	1040	1000	950	890	840	780	730	690	640	600
		B	930	870	810	750	700	650	600	550	510	460
		C	860	810	730	680	630	580	530	470	420	370
		D	810	760	670	620	570	520	470	410	360	300
	Low Heat	A	880	820	750	700	640	590	550	490	440	390
		B	690	620	550	490	430	370	320	230	160	100
		C	490	440	390	350	310	270	230	160	110	70
		D	350	310	270	250	220	190	160	110	80	50
PCG6A36100	High Cool	A	1340	1300	1260	1220	1170	1120	1070	1020	960	920
		B	1210	1170	1120	1070	1020	960	910	860	810	770
		C	1010	950	890	830	760	710	660	620	570	500
		D	920	860	790	720	670	610	560	510	450	330
	Low Cool	A	940	880	810	750	690	640	580	540	480	370
		B	800	740	660	590	540	490	440	370	310	100
		C	480	440	390	350	330	290	260	220	180	60
		D	400	370	330	290	270	240	220	190	150	50
	High Heat	A	1670	1640	1600	1570	1530	1490	1450	1410	1360	1330
		B	1530	1490	1450	1410	1370	1330	1280	1230	1170	1120
		C	1340	1300	1260	1220	1170	1120	1070	1020	960	920
		D	1270	1230	1180	1140	1090	1030	980	930	880	840
	Low Heat	A	1410	1370	1340	1300	1250	1210	1160	1110	1050	1000
		B	1270	1230	1180	1140	1090	1030	980	930	880	840
		C	1150	1100	1050	1000	950	890	830	790	740	700
		D	980	930	870	810	740	690	630	590	540	460

Continued on following pages. See Notes at end of table.

AIRFLOW PERFORMANCE - SIDE DUCT APPLICATION (Continued)

Model	Jumper Position	External Static Pressure (in. W.C.)										
		0.1	0.2	0.3	0.4	0.5	0.6	0.7	0.8	0.9	1.0	
		SCFM	SCFM	SCFM	SCFM	SCFM	SCFM	SCFM	SCFM	SCFM	SCFM	
PCG6B48065	High Cool	A	1760	1720	1680	1640	1610	1570	1520	1480	1440	1390
		B	1660	1620	1570	1540	1500	1460	1420	1370	1330	1280
		C	1480	1440	1390	1350	1300	1260	1210	1170	1110	1050
		D	1330	1280	1240	1190	1140	1090	1030	980	920	850
	Low Cool	A	1390	1340	1300	1250	1200	1150	1100	1050	990	920
		B	1330	1280	1240	1190	1140	1090	1030	980	920	850
		C	1080	1020	970	910	850	780	700	650	580	520
		D	880	820	740	670	590	530	470	380	190	230
	High Heat	A	1190	1130	1080	1030	970	910	840	790	730	660
		B	1120	1070	1020	960	900	830	760	700	640	580
		C	1010	940	880	820	750	680	610	550	440	410
		D	910	840	770	700	620	560	500	420	240	270
	Low Heat	A	1160	1110	1060	1000	950	880	810	760	700	630
		B	960	890	830	760	690	620	550	480	340	340
		C	830	760	690	610	520	470	410	320	100	160
		D	500	460	410	360	310	280	240	190	60	100
PCG6B48100	High Cool	A	1760	1720	1680	1640	1610	1570	1520	1480	1440	1390
		B	1660	1620	1570	1540	1500	1460	1420	1370	1330	1280
		C	1480	1440	1390	1350	1300	1260	1210	1170	1110	1050
		D	1330	1280	1240	1190	1140	1090	1030	980	920	850
	Low Cool	A	1390	1340	1300	1250	1200	1150	1100	1050	990	920
		B	1330	1280	1240	1190	1140	1090	1030	980	920	850
		C	1080	1020	970	910	850	780	700	650	580	520
		D	880	820	740	670	590	530	470	380	190	230
	High Heat	A	1790	1750	1710	1670	1640	1600	1550	1510	1470	1430
		B	1600	1550	1510	1470	1430	1380	1340	1300	1250	1200
		C	1410	1360	1320	1270	1220	1170	1120	1070	1020	950
		D	1330	1280	1240	1190	1140	1090	1030	980	920	850
	Low Heat	A	1480	1440	1390	1350	1300	1260	1210	1170	1110	1050
		B	1330	1280	1240	1190	1140	1090	1030	980	920	850
		C	1210	1160	1110	1050	1000	940	870	820	760	690
		D	1030	970	910	850	790	720	640	580	480	450
PCG6B48125	High Cool	A	1760	1720	1680	1640	1610	1570	1520	1480	1440	1390
		B	1660	1620	1570	1540	1500	1460	1420	1370	1330	1280
		C	1480	1440	1390	1350	1300	1260	1210	1170	1110	1050
		D	1330	1280	1240	1190	1140	1090	1030	980	920	850
	Low Cool	A	1390	1340	1300	1250	1200	1150	1100	1050	990	920
		B	1330	1280	1240	1190	1140	1090	1030	980	920	850
		C	1080	1020	970	910	850	780	700	650	580	520
		D	880	820	740	670	590	530	470	380	190	230
	High Heat	A	2080	2020	1980	1930	1880	1830	1800	1740	1660	1580
		B	2040	2000	1960	1920	1880	1840	1800	1760	1710	1670
		C	1870	1830	1790	1750	1720	1680	1630	1590	1550	1520
		D	1700	1660	1620	1580	1540	1500	1460	1420	1380	1330
	Low Heat	A	2080	2020	1980	1930	1880	1830	1800	1740	1660	1580
		B	2040	2000	1960	1920	1880	1840	1800	1760	1710	1670
		C	1580	1540	1490	1450	1410	1370	1320	1280	1230	1180
		D	1440	1400	1350	1310	1260	1210	1170	1120	1070	1000
PCG6B60065	High Cool	A	1960	1930	1890	1850	1820	1790	1740	1700	1660	1630
		B	1880	1850	1810	1770	1740	1700	1660	1630	1590	1550
		C	1650	1610	1570	1530	1490	1460	1420	1380	1340	1300
		D	1470	1420	1380	1340	1290	1260	1210	1160	1110	1060
	Low Cool	A	1450	1400	1360	1310	1270	1230	1180	1130	1080	1030
		B	1410	1360	1320	1270	1220	1190	1130	1080	1030	970
		C	1130	1070	1020	960	900	820	760	710	650	610
		D	1030	970	900	840	760	690	620	570	490	450
	High Heat	A	1280	1220	1180	1130	1070	1030	970	910	850	790
		B	1130	1070	1020	960	900	820	760	710	650	610
		C	1030	970	900	840	760	690	620	570	490	450
		D	870	800	710	620	550	480	400	360	230	140
	Low Heat	A	1230	1170	1120	1070	1010	960	900	840	780	730
		B	1090	1020	960	910	840	750	690	640	580	550
		C	870	800	710	620	550	480	400	360	230	140
		D	650	590	520	440	380	330	260	230	110	30

See Notes at end of table on next page.

AIRFLOW PERFORMANCE - SIDE DUCT APPLICATION (Continued)

Model	Jumper Position	External Static Pressure (in. W.C.)										
		0.1	0.2	0.3	0.4	0.5	0.6	0.7	0.8	0.9	1.0	
		SCFM	SCFM	SCFM	SCFM	SCFM	SCFM	SCFM	SCFM	SCFM	SCFM	
PCG6B60100	High Cool	A	1960	1930	1890	1850	1820	1790	1740	1700	1660	1630
		B	1880	1850	1810	1770	1740	1700	1660	1630	1590	1550
		C	1650	1610	1570	1530	1490	1460	1420	1380	1340	1300
		D	1470	1420	1380	1340	1290	1260	1210	1160	1110	1060
	Low Cool	A	1450	1400	1360	1310	1270	1230	1180	1130	1080	1030
		B	1410	1360	1320	1270	1220	1190	1130	1080	1030	970
		C	1130	1070	1020	960	900	820	760	710	650	610
		D	1030	970	900	840	760	690	620	570	490	450
	High Heat	A	1730	1690	1660	1620	1580	1540	1510	1470	1440	1400
		B	1540	1500	1460	1420	1380	1340	1300	1260	1220	1170
		C	1410	1360	1320	1270	1220	1190	1130	1080	1030	970
		D	1330	1270	1230	1180	1130	1100	1040	980	910	850
	Low Heat	A	1580	1540	1500	1460	1420	1380	1340	1300	1260	1210
		B	1330	1270	1230	1180	1130	1100	1040	980	910	850
		C	1180	1120	1070	1020	950	890	830	770	710	670
		D	1030	970	900	840	760	690	620	570	490	450
PCG6B60125	High Cool	A	1960	1930	1890	1850	1820	1790	1740	1700	1660	1630
		B	1880	1850	1810	1770	1740	1700	1660	1630	1590	1550
		C	1650	1610	1570	1530	1490	1460	1420	1380	1340	1300
		D	1470	1420	1380	1340	1290	1260	1210	1160	1110	1060
	Low Cool	A	1450	1400	1360	1310	1270	1230	1180	1130	1080	1030
		B	1410	1360	1320	1270	1220	1190	1130	1080	1030	970
		C	1130	1070	1020	960	900	820	760	710	650	610
		D	1030	970	900	840	760	690	620	570	490	450
	High Heat	A	2200	2160	2130	2090	2060	2020	1980	1980	1940	1910
		B	2060	2020	1990	1960	1920	1880	1840	1800	1770	1730
		C	1920	1890	1850	1810	1780	1740	1700	1660	1630	1590
		D	1760	1720	1690	1650	1610	1570	1530	1500	1460	1430
	Low Heat	A	2200	2160	2130	2090	2060	2020	1980	1980	1940	1910
		B	1970	1940	1910	1870	1830	1800	1750	1720	1680	1640
		C	1680	1650	1610	1570	1530	1500	1460	1420	1390	1350
		D	1670	1630	1590	1550	1510	1480	1440	1400	1360	1320

Notes:

Airflow tested with dry coil conditions, without air filters, at 230 V.

Applications above 0.8 in. W.C. external static pressure are not recommended.

Brushless DC high efficiency enhanced ECM blower motor used for all indoor blower assemblies.

Minimal variations in airflow performance data result from operating at 208 V. The data in the table can be used in those cases.

The differences between side duct airflows and bottom duct airflows are insignificant.

Heating applications are tested at 0.50 in. W.C. external static pressure. Cooling applications are tested per AHRI Standard 210/240.

ADDITIONAL STATIC RESISTANCE

Size (Tons)	CFM	Wet Indoor Coil	Economizer ¹	Filter/Frame Kit
024 (2.0)	500	0.01	0.00	0.01
	600	0.01	0.00	0.02
	700	0.01	0.00	0.04
	800	0.02	0.01	0.06
	900	0.03	0.01	0.08
	1000	0.04	0.01	0.10
	1100	0.05	0.01	0.13
1200	0.06	0.02	0.16	
036 (3.0)	700	0.01	0.00	0.04
	800	0.02	0.01	0.06
	900	0.03	0.01	0.08
	1000	0.04	0.01	0.10
	1100	0.05	0.01	0.13
	1200	0.06	0.02	0.16
	1300	0.07	0.03	0.17
1400	0.08	0.04	0.18	
048 (4.0)	1100	0.02	0.02	0.04
	1200	0.03	0.02	0.04
	1300	0.04	0.02	0.05
	1400	0.05	0.03	0.05
	1500	0.06	0.04	0.06
	1600	0.07	0.04	0.07
	1700	0.07	0.04	0.08
	1800	0.08	0.04	0.09
1900	0.09	0.05	0.10	
2000	0.09	0.05	0.11	
060 (5.0)	1100	0.02	0.02	0.04
	1200	0.03	0.02	0.04
	1300	0.04	0.02	0.05
	1400	0.05	0.03	0.05
	1500	0.06	0.04	0.06
	1600	0.07	0.04	0.07
	1700	0.07	0.04	0.08
	1800	0.08	0.04	0.09
1900	0.09	0.05	0.10	
2000	0.09	0.05	0.11	

1. The pressure drop through the economizer is greater for 100% outdoor air than for 100% return air. If the resistance of the return air duct is less than 0.25 IWG, the unit delivers less CFM during full economizer operation.

Note: Filter pressure drop based on standard filter media tested at velocities not to exceed 300 ft/min.

BOTTOM DUCT DIMENSIONS (in.)

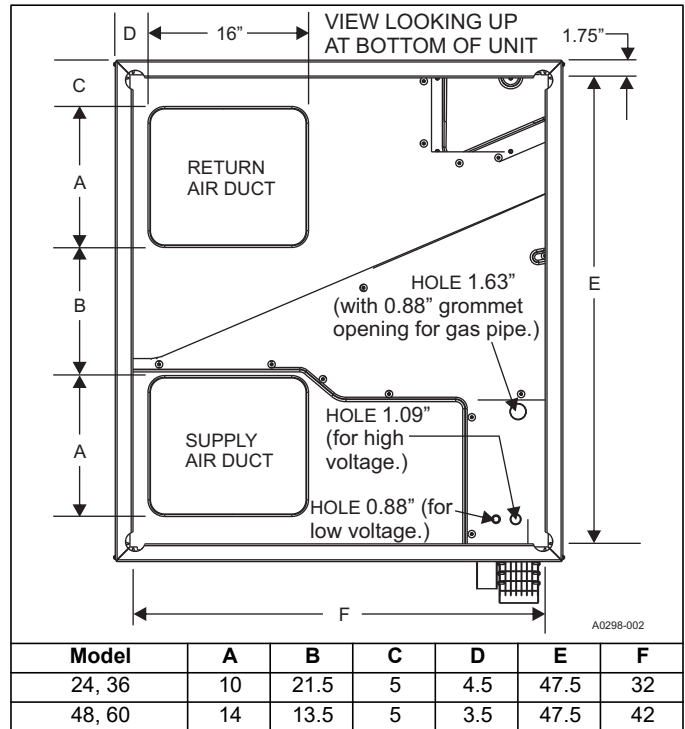

REAR DUCT DIMENSIONS (in.)

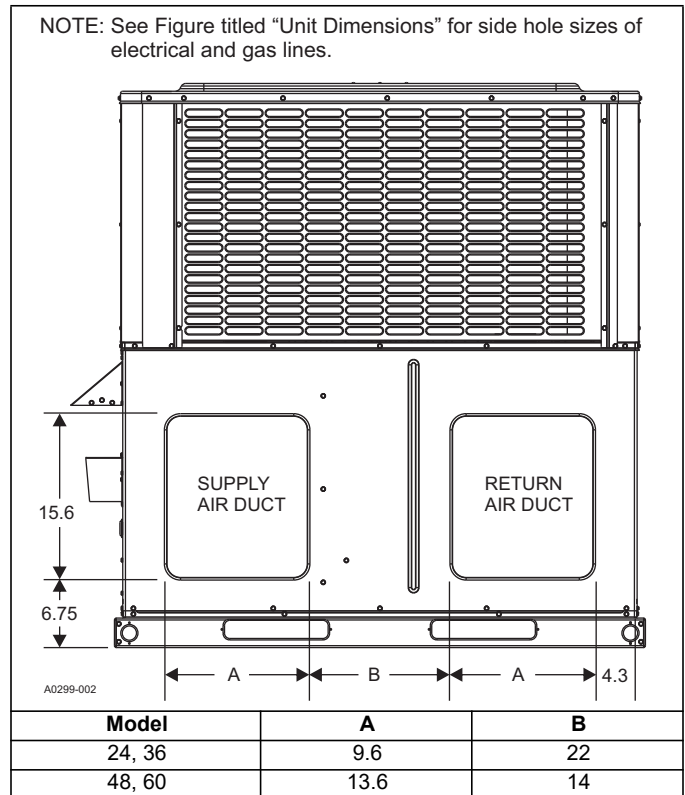

UNIT TYPICAL DUCT APPLICATIONS

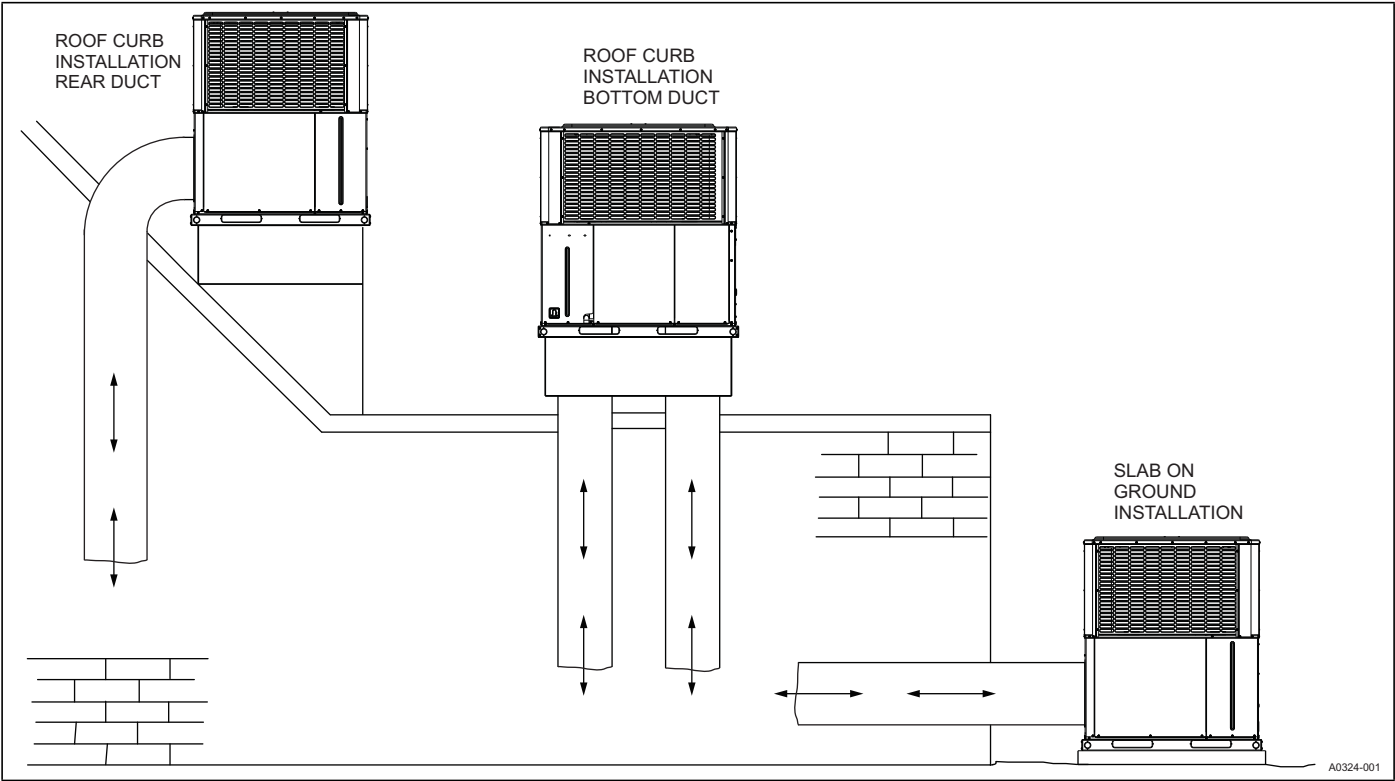

UNIT TYPICAL SLAB ON GROUND INSTALLATION

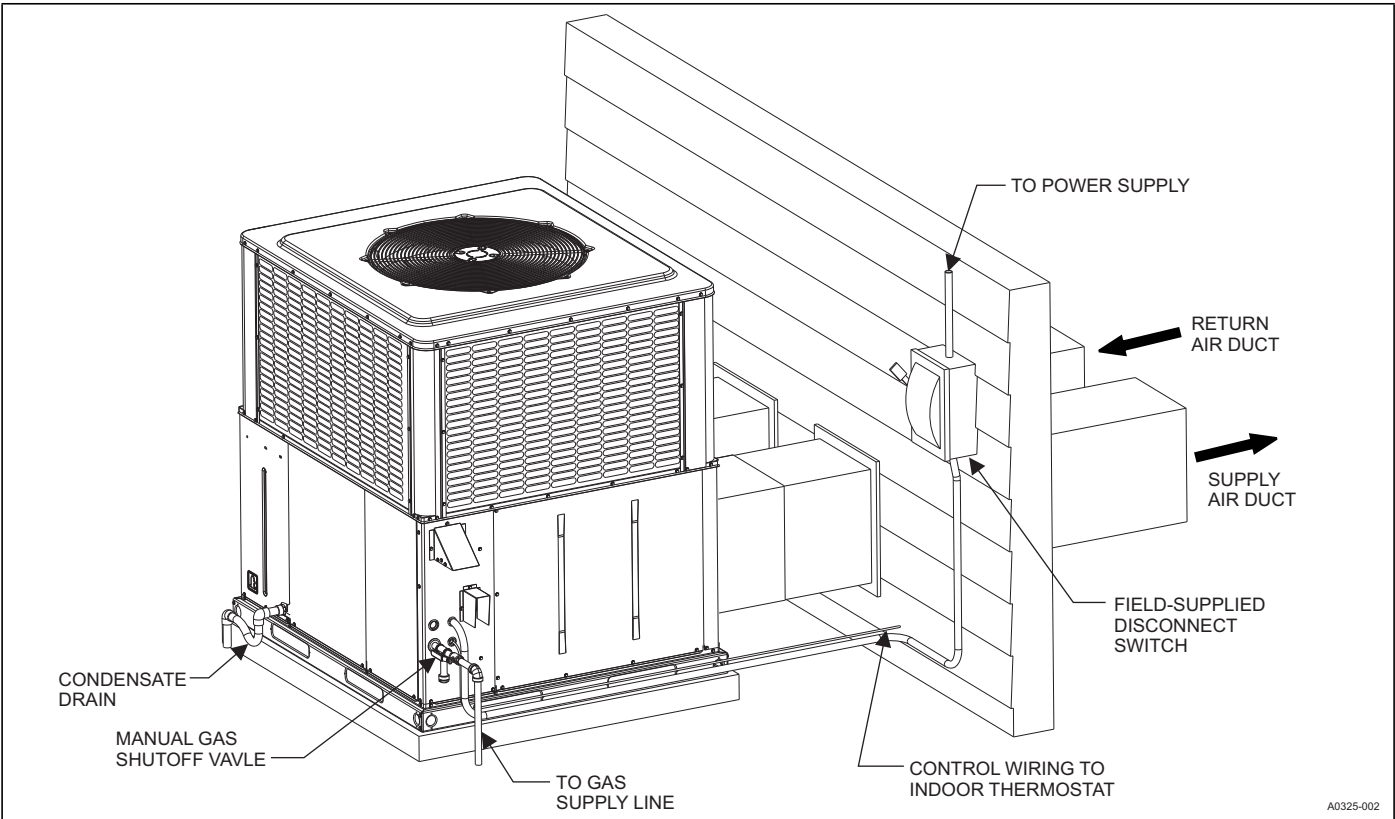

UNIT TYPICAL ROOF CURB INSTALLATION

