

CEILING-MOUNTED AIR HANDLERS 1½ TO 2½ TONS

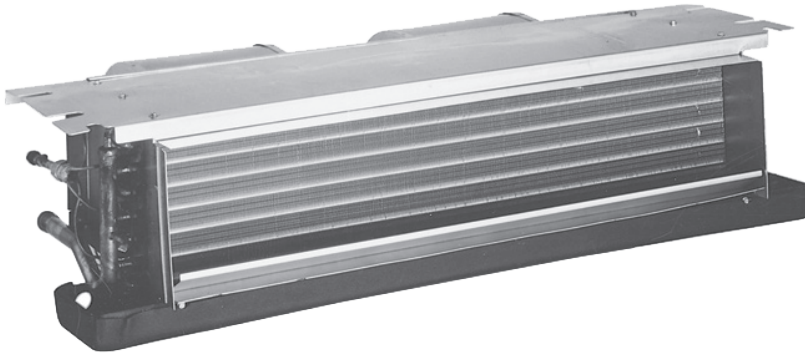

■ Contents

Nomenclature	2
Product Specifications	3
Dimensions	6
Airflow Data	7
Heat Kit Data	7
Wiring Diagram	8
Accessories	12

■ Product Features

- Check flowrate for heat pump and cooling-only applications
- All-Aluminum tube/aluminum fin coil
- Direct-drive, resilient-mount, multi-speed motor
- Sequence-controlled and rust-resistant nickel chromium heating elements of 5, 6, 8 and 10 kW
- High-efficiency evaporator coil
- Quiet operation
- Models with EEM motors: ACNF25 & ACNF31
- Models with PSC motors: ACNF18, ACNF24, & ACNF30
- Available with and without heat
- AHRI Certified; ETL Listed
- Primary/secondary drain connection in a high-temperature plastic drain pan
- Suitable for free-return installation (non-ducted return air)
- Galvanized-steel construction
- Factory-installed pull-type disconnect
- Easy service access



* Complete warranty details available from your local dealer or at www.daikincomfort.com. To receive the 12-Year Parts Limited Warranty, online registration must be completed within 60 days of installation. Online registration is not required in California or Québec.

	ACNF18 001	ACNF18 051	ACNF18 061	ACNF18 081	ACNF24 001	ACNF24 051	ACNF24 061	ACNF24 081
PERFORMANCE RATINGS								
Cooling (BTU/h)	18,000	18,000	18,000	18,000	24,000	24,000	24,000	24,000
Piston Size ²	0.051	0.051	0.051	0.051	0.057	0.057	0.057	0.057
BLOWER								
Diameter	5.75	5.75	5.75	5.75	6.31	6.31	6.31	6.31
Width	6.75	6.75	6.75	6.75	8.25	8.25	8.25	8.25
Coil Drain Connect FPT	3/4"	3/4"	3/4"	3/4"	3/4"	3/4"	3/4"	3/4"
BLOWER MOTOR								
FLA	0.72	0.72	0.72	0.72	1.34	1.34	1.34	1.34
HP	1/8	1/8	1/8	1/8	1/4	1/4	1/4	1/4
REFRIGERANT LINE CONNECTION SIZE								
Liquid	3/8"	3/8"	3/8"	3/8"	3/8"	3/8"	3/8"	3/8"
Suction	3/4"	3/4"	3/4"	3/4"	3/4"	3/4"	3/4"	3/4"
ELECTRICAL DATA								
Voltage	208/230	208/230	208/230	208/230	208/230	208/230	208/230	208/230
Min Circuit Ampacity @ 230V	0.9	27	33.5	40.6	1.68	27.8	34.3	41.3
Min Circuit Ampacity @ 208V	0.9	23.5	29.2	35.3	1.68	24.3	29.9	36.1
Max. Overcurrent Device @ 230V	15	30	35	45	15	30	35	45
Max. Overcurrent Device @ 208V	15	25	30	40	15	25	30	40
Minimum Voltage VAC	197	197	197	197	197	197	197	197
Maximum Voltage VAC	253	253	253	253	253	253	253	253
ELECTRIC HEAT								
kW @ 230 Volts	0.0	4.8	6.0	7.3	0.0	4.8	6.0	7.3
BTU/h @ 230 Volts	0	16,400	20,500	24,900	0	16,400	20,500	24,900
SHIP WEIGHT (LBS)								
	59	59	59	59	69	69	69	69

¹ CFM @.3 static

²Shipped with Coil

NOTES

- For a properly matched system and piston sizing information, refer to Amana piston kit chart of the corresponding Amana® outdoor unit.
- When the room thermostat calls for second stage heat, the first stage (heat pump) operation must be locked out. When matching the "AC" unit that has electric heat with a heat pump, order "HEAT PUMP SHUT OFF KIT HPSK-01." The ACXX-00 units do not require this kit.

PRODUCT SPECIFICATIONS

	ACNF24 101	ACNF25 0016	ACNF25 0516	ACNF25 0616	ACNF25 0816	ACNF25 1016	ACNF30 001	ACNF30 051
PERFORMANCE RATINGS								
Cooling (BTU/h)	24,000	24,000	24,000	24,000	24,000	24,000	30,000	30,000
Piston Size ²	0.057	0.055	0.055	0.055	0.055	0.055	0.061	0.061
BLOWER								
Diameter	6.31	6.31	6.31	6.31	6.31	6.31	6.75	6.75
Width	8.25	8.25	8.25	8.25	8.25	8.25	8.25	8.25
Coil Drain Connect FPT	3/4"	3/4"	3/4"	3/4"	3/4"	3/4"	3/4"	3/4"
BLOWER MOTOR								
FLA	1.34	2	2	2	2	2	1.34	1.34
HP	1/4	1/4	1/4	1/4	1/4	1/4	1/4	1/4
REFRIGERANT LINE CONNECTION SIZE								
Liquid	3/8"	3/8"	3/8"	3/8"	3/8"	3/8"	3/8"	3/8"
Suction	3/4"	3/4"	3/4"	3/4"	3/4"	3/4"	3/4"	3/4"
ELECTRICAL DATA								
Voltage	208/230	208/230	208/230	208/230	208/230	208/230	208/230	208/230
Min Circuit Ampacity @ 230V	54.9	2.5	28.6	35.1	42.2	55.8	1.68	27.8
Min Circuit Ampacity @ 208V	47.8	2.5	26.1	32.0	38.4	50.7	1.68	24.3
Max. Overcurrent Device @ 230V	60	15	30	40	45	60	15	30
Max. Overcurrent Device @ 208V	50	15	30	35	40	60	15	25
Minimum Voltage VAC	197	197	197	197	197	197	197	197
Maximum Voltage VAC	253	253	253	253	253	253	253	253
ELECTRIC HEAT								
kW @ 230 Volts	9.8	0.0	4.8	6.0	7.3	9.8	0.0	4.8
BTU/h @ 230 Volts	33,500	0	16,400	20,500	24,900	33,500	0	16,400
SHIP WEIGHT (LBS)								
	69	69	69	69	69	69	79	79

¹ CFM @ .2 static

Note: When the room thermostat calls for second stage heat, the first stage (heat pump) operation must be locked out. When matching the "AC" unit that has electric heat with a heat pump, order "HEAT PUMP SHUT OFF KIT HPSK-01." The ACXX-00 units do not require this kit.

	ACNF30 061	ACNF30 081	ACNF30 101	ACNF31 0016	ACNF31 0516	ACNF31 0616	ACNF31 0816	ACNF31 1016
PERFORMANCE RATINGS								
Cooling (BTU/h)	30,000	30,000	30,000	30,000	30,000	30,000	30,000	30,000
Piston Size ²	0.061	0.061	0.061	0.059	0.059	0.059	0.059	0.059
BLOWER								
Diameter	6.75	6.75	6.75	6.75	6.75	6.75	6.75	6.75
Width	8.25	8.25	8.25	8.25	8.25	8.25	8.25	8.25
Coil Drain Connect FPT	3/4"	3/4"	3/4"	3/4"	3/4"	3/4"	3/4"	3/4"
BLOWER MOTOR								
FLA	1.34	1.34	1.34	2	2	2	2	2
HP	1/4	1/4	1/4	1/4	1/4	1/4	1/4	1/4
REFRIGERANT LINE CONNECTION SIZE								
Liquid	3/8"	3/8"	3/8"	3/8"	3/8"	3/8"	3/8"	3/8"
Suction	3/4"	3/4"	3/4"	3/4"	3/4"	3/4"	3/4"	3/4"
ELECTRICAL DATA								
Voltage	208/230	208/230	208/230	208/230	208/230	208/230	208/230	208/230
Min Circuit Ampacity @ 230V	34.3	41.3	54.9	2.5	28.6	35.1	42.2	55.8
Min Circuit Ampacity @ 208V	29.9	36.1	47.8	2.5	26.1	32.0	38.4	50.7
Max. Overcurrent Device @ 230V	35	45	60	15	30	40	45	60
Max. Overcurrent Device @ 208V	30	40	50	15	30	35	40	60
Minimum Voltage VAC	197	197	197	197	197	197	197	197
Maximum Voltage VAC	253	253	253	253	253	253	253	253
ELECTRIC HEAT								
kW @ 230 Volts	6.0	7.3	9.8	0.0	4.8	6.0	7.3	9.8
BTU/h @ 230 Volts	20,500	24,900	33,500	0	16,400	20,500	24,900	33,500
SHIP WEIGHT (LBS)								
	79	79	79	79	79	79	79	79

¹ CFM @ .2 static

Note: When the room thermostat calls for second stage heat, the first stage (heat pump) operation must be locked out. When matching the "AC" unit that has electric heat with a heat pump, order "HEAT PUMP SHUT OFF KIT HPSK-01." The ACXX-00 units do not require this kit.

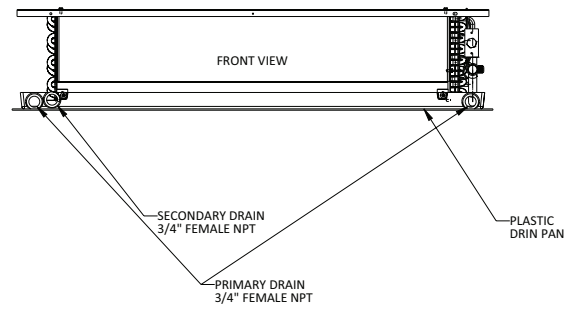
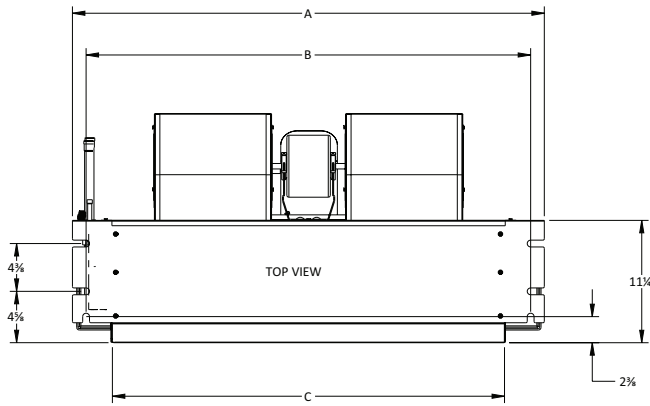
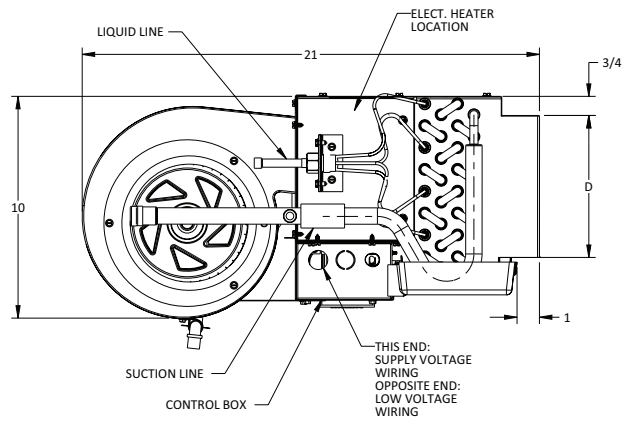

	ACNF18	ACNF24	ACNF25	ACNF30	ACNF31
A	37 $\frac{1}{4}$ "	43 $\frac{1}{4}$ "	43 $\frac{1}{4}$ "	49 $\frac{1}{4}$ "	49 $\frac{1}{4}$ "
B	34 $\frac{3}{4}$ "	40 $\frac{3}{4}$ "	40 $\frac{3}{4}$ "	46 $\frac{3}{4}$ "	46 $\frac{3}{4}$ "
C	30"	36"	36"	42"	42"
D	6 $\frac{1}{2}$ "	6 $\frac{1}{2}$ "	6 $\frac{1}{2}$ "	6 $\frac{1}{2}$ "	6 $\frac{1}{2}$ "

MODEL	MOTOR SPEED	CFM DELIVERED AGAINST EXTERNAL STATIC PRESSURE				
		0.1"	0.2"	0.3"	0.4"	0.5"
ACNF18****	High	710	660	590	515	435
	Low	650	595	540	480	390
ACNF24****	High	955	880	820	740	675
	Low	885	840	775	725	620
ACNF25****	T5	969	912	854	798	778
	T4	969	912	854	798	778
	T3	802	776	690	641	584
	T2	680	610	550	484	431
	T1	680	610	550	484	431
ACNF30****	High	1,075	1,005	920	820	730
	Low	945	890	835	760	650
ACNF31****	T5	999	928	868	824	764
	T4	999	928	868	824	764
	T3	871	798	750	687	614
	T2	763	695	625	548	478
	T1	763	695	625	548	478

Note: Airflow data for 240 Vac with dry coil and no filter in place.

HEATING CAPACITY/KW CORRECTION FACTOR

SUPPLY VOLTAGE	240	230	220	210	208
CORRECTION FACTOR	1.08	1.00	0.92	0.84	0.82

(Multiply the 230-volt capacity by factors)

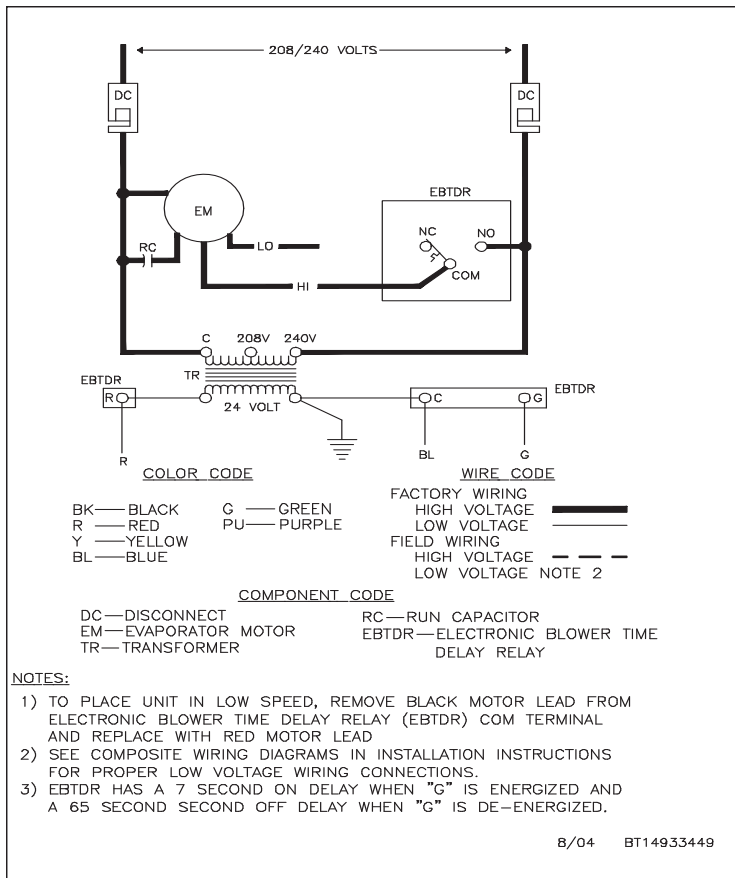
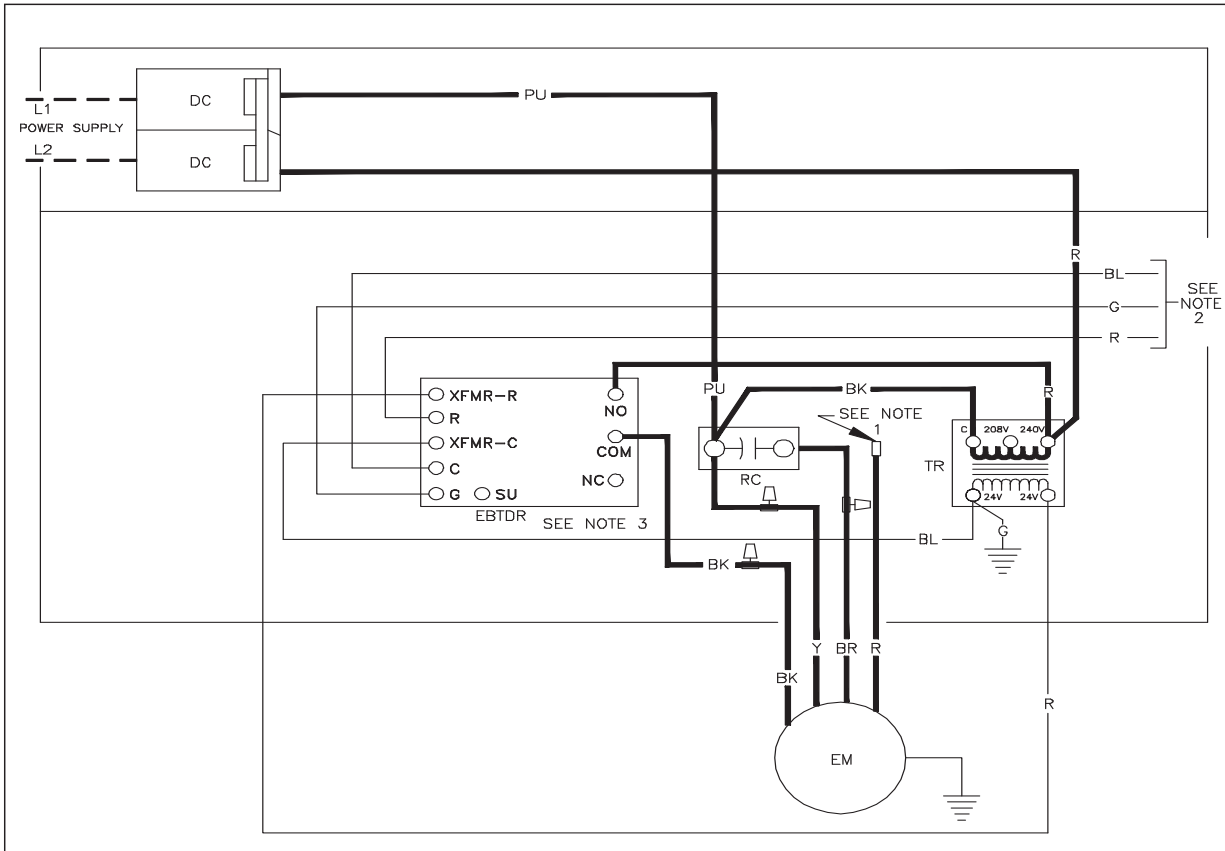

High Voltage: Disconnect all power before servicing or installing this unit. Multiple power sources may be present. Failure to do so may cause property damage, personal injury, or death.

WARNING

Wiring is subject to change. Always refer to the wiring diagram on the unit for the most up-to-date wiring.

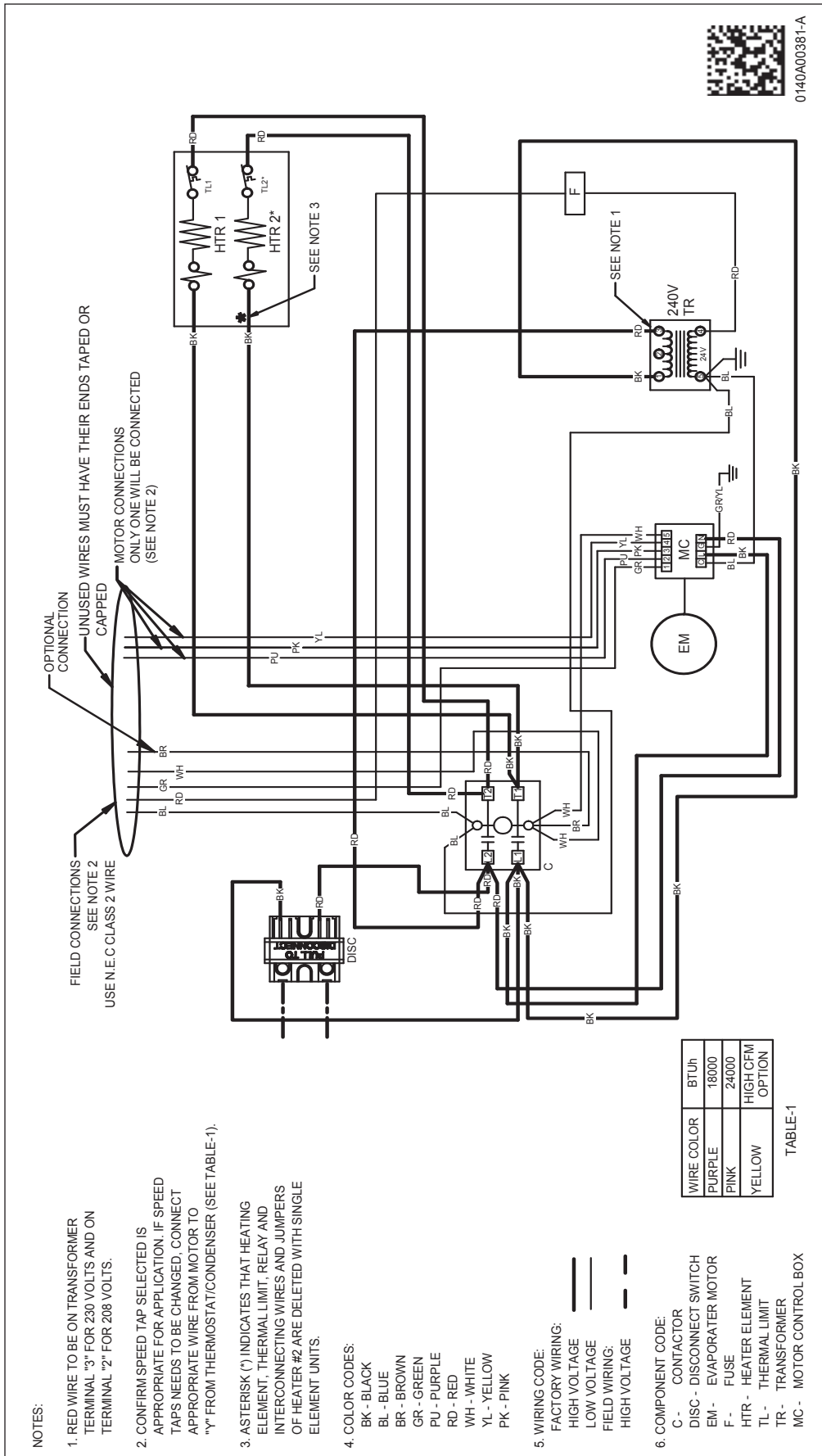

WARNING

High Voltage: Disconnect all power before servicing or installing this unit. Multiple power sources may be present. Failure to do so may cause property damage, personal injury, or death.

Wiring is subject to change. Always refer to the wiring diagram on the unit for the most up-to-date wiring.

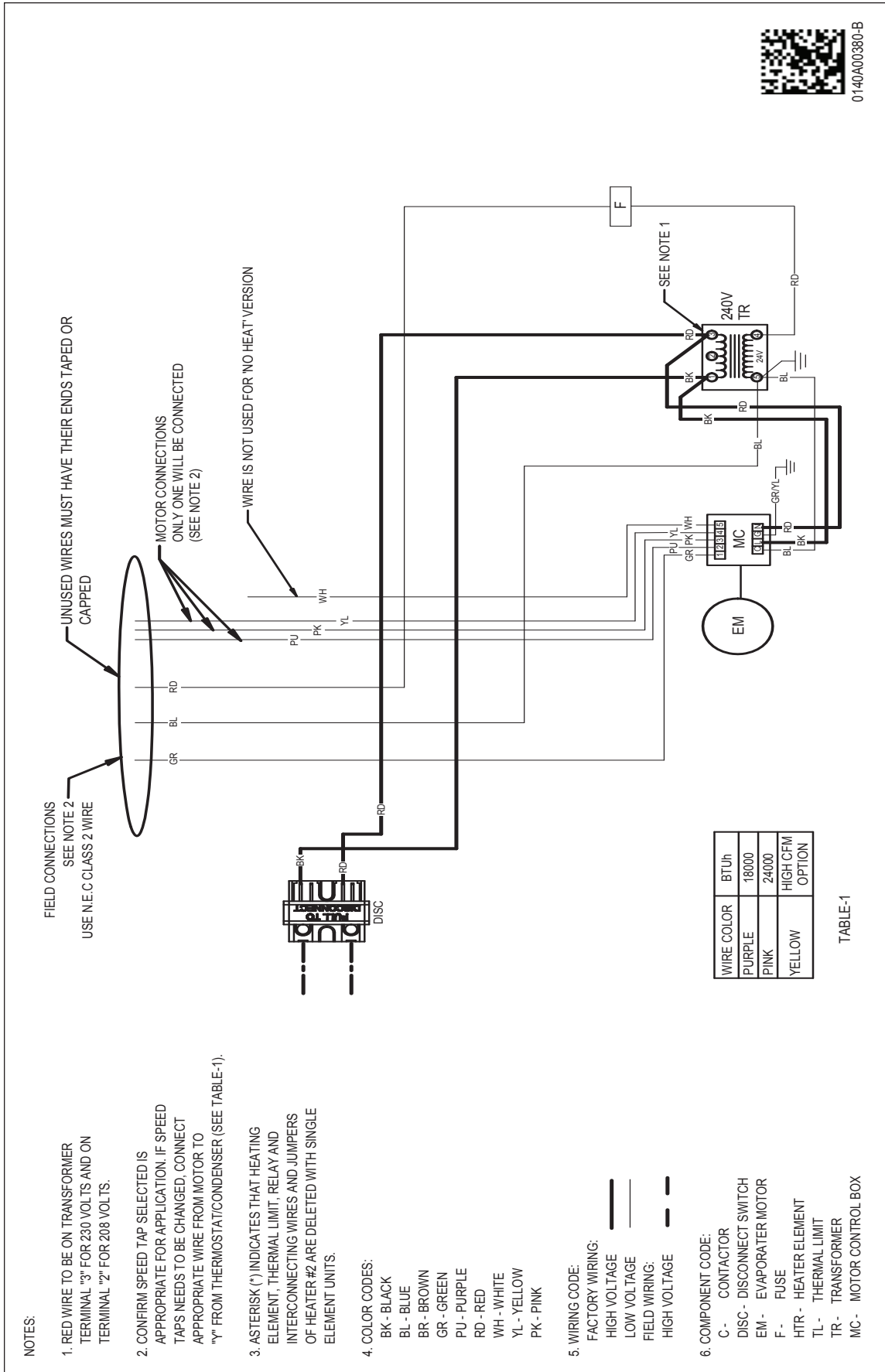

WARNING

High Voltage: Disconnect all power before servicing or installing this unit. Multiple power sources may be present. Failure to do so may cause property damage, personal injury, or death.

Wiring is subject to change. Always refer to the wiring diagram on the unit for the most up-to-date wiring.

MODEL	DESCRIPTION
HPSK-01	Heat Pump Shut-off Relay Kit
LOUVERED CEILING ACCESS PANELS	
CAP-1/ 1L	Fits ACNF18
CAP-2/ 2L	Fits ACNF24/ 25
CAP-3/ 3L	Fits ACNF30/ 31