

GreenSource i Series Model WQ Water Source Heat Pump 1.5 to 5 Ton

Engineering
Submittal
Sheet



BOSCH

Overview and Certifications



Standard Features, Factory Installed Options, and Field Install Accessories

Standard Features

- ▶ **Available in Horizontal and Vertical Cabinets**
 - Constructed using galvanized steel
 - Standard hanging bracket kits on HZ units for suspending the unit from field supplied hanger rods
- ▶ **Single Stage Compact**
 - Up to 15.1 EER (WLHP)
 - ECM DecStar blower motors for all sizes
- ▶ **Unit Configuration**
 - Left hand or right hand return air
 - Top or end supply air
 - Copper or Cupro-Nickel Coaxial Coil
- ▶ **Standard 1" Throwaway Filter with 2 side Filter Rack**
- ▶ **1/2" Dual Density Fiber Insulation in Air Handler Section**
 - Non-combustible, non-hydroscopic and does not support fungal growth
 - Meets NFPA 90A and 90B for fire protection
 - Meets the GREENGUARD Indoor Air Quality Standard
 - Sound blocker 1/8" mass loaded vinyl and 3/8" closed cell foam laminated material on panels in condensing section.
 - Compressor encapsulation
- ▶ **Compressors**
 - Floating compressor base pan for quiet operation
 - Scroll type compressors on sizes 024 through 060
 - Rotary type compressor on size 018
- ▶ **TXV (Thermal Expansion Valve)**
 - Improves refrigerant management and efficiencies

GreenSource i Series Model WQ

Water Source Heat Pump 1.5 to 5 Ton



Standard Features, Factory Installed Options, and Field Install Accessories continued..

► Reliability - Durability - Serviceability

- UPM circuit board with communicating features
- Vertical units are completely serviceable from the front of the unit as well as insulated bulkheads that allow the unit to be serviced during operation.

► DuoGuard™ Evaporator Coil

- Tin Electro-Plated Copper Tubing Hair Pins with high-tech polymer coated Aluminum fins will protect the evaporator coil from most forms of corrosive elements in the airstream

► Electronic Circuit Board UPM

- The electronic circuit board provides protection with:
 - Random Start of Unit
 - Anti-Short Cycling (5 minute delay)
 - Alarm communicating output
 - Low pressure switch bypass for 120 seconds at cold water start up
- It also monitors and communicates standard safety features/alerts/operation/protection:
 - Low Pressure Switch
 - High Pressure Switch
 - Evaporator Freeze Protection
 - Water Coil Freeze Switch
 - Condensate Overflow Switch
- This circuit board can be connected to a Bosch thermostat that alerts the customer of adverse conditions

► 75 VA Transformer

► Warranty

- 1 year all parts limited warranty
- 5 year compressor limited warranty
- For full warranty details:
<https://www.bosch-climate.us/support-center/product-warranty-library/residential-heat-pumps-geothermal-warranty-documents.html>

► Field Configurable Horizontal Discharge Air Conversion

- The horizontal models allow field conversion of discharge air from end blow to straight through configuration

► Water Connections

- All water connections are heavy duty bronze FPT fittings securely fastened to the unit corner post

Factory Installed Options

► Cupro-nickel Coil

- Recommended in conditions anticipating moderate scale formation or in brackish water

Field Install Options

► Thermostats

- Bosch thermostats are fully customized to meet your individual needs. Bosch offers connected thermostats that can display alert messages without having to go to the unit.

► Externally Mounted Duct Heater Kits

► Swivel Water Connections

- 3/4" or 1" FPT Swivel Water Connection

► Pump/Valve Relay Kit

- This relay is used to energize a supply pump or solenoid valve when there is a call for compressor operation. This relay can be used to switch either high or low voltage power.

► SmartStart Assist Kit

- An option which provides a means of reducing inrush currents at compressor startup. Light flickering is reduced, and a smooth start is achieved (only available on scroll compressor models).

► Stainless Steel Hose Kits

- Available in various lengths and diameters depending on the need for your application.

► Flow Center Kits

Greensource i Series Model WQ

Water Source Heat Pump 1.5 to 5 Ton



BOSCH

Model Nomenclature

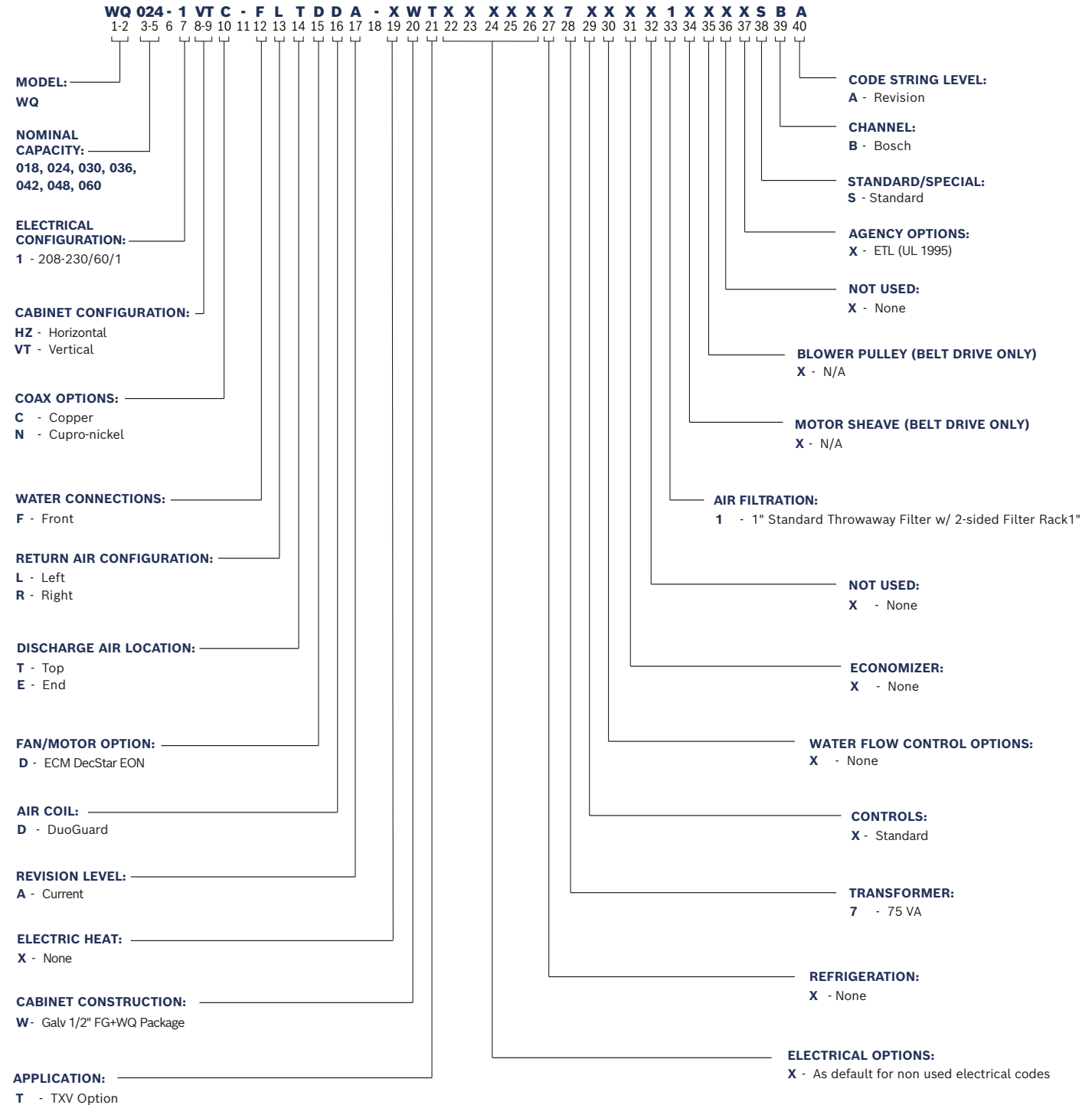

Greensource i Series Model WQ

Water Source Heat Pump 1.5 to 5 Ton



BOSCH

AHRI Ratings (13256-1) - WQ Series Copper Water Coil

Model Number	Cabinet	Water Loop Heat Pump				Ground Loop Heat Pump				CFM	GPM
		Cooling 86 deg.F		Heating 68 deg.F		Cooling 77 deg.F		Heating 32 deg.F			
		Capacity Btuh	EER Btuh/W	Capacity Btuh	COP	Capacity Btuh	EER Btuh/W	Capacity Btuh	COP		
018	VT	18500	14.70	20000	4.80	19500	17.00	13900	3.60	650	5
018	HZ	18500	14.70	20000	4.80	19500	17.00	13900	3.60	650	5
024	VT	24550	15.00	27150	4.85	25650	17.95	17750	3.40	800	6
024	HZ	24200	14.75	26800	5.15	25300	17.65	17850	3.70	800	6
030	VT	28650	14.50	32150	4.95	29950	17.00	21050	3.60	950	7
030	HZ	28650	14.60	32150	4.95	29950	17.10	21050	3.60	950	7
036	VT	36400	15.05	38400	4.85	37950	17.55	26700	3.70	1200	9
036	HZ	36400	14.85	38450	4.80	38000	17.40	26750	3.65	1200	9
042	VT	39950	14.70	42150	4.70	41800	17.20	29350	3.40	1400	10
042	HZ	38350	13.95	42350	4.60	41100	16.80	29550	3.35	1400	10
048	VT	46450	14.35	58200	4.65	48650	16.85	38900	3.50	1600	12
048	HZ	46450	14.35	58300	4.75	48000	16.55	39000	3.45	1600	12
060	VT	58500	14.20	77000	4.70	61250	16.50	52050	3.70	1850	15
060	HZ	58900	14.20	66200	4.35	61000	16.25	46000	3.35	1850	15

AHRI Ratings (13256-1) - WQ Series Cupro-Nickel Water Coil

Model Number	Cabinet	Water Loop Heat Pump				Ground Loop Heat Pump				CFM	GPM
		Cooling 86 deg.F		Heating 68 deg.F		Cooling 77 deg.F		Heating 32 deg.F			
		Capacity Btuh	EER Btuh/W	Capacity Btuh	COP	Capacity Btuh	EER Btuh/W	Capacity Btuh	COP		
018	VT	18400	14.60	19900	4.80	19300	17.00	13800	3.60	650	5
018	HZ	18400	14.60	19900	4.80	19300	17.00	13800	3.60	650	5
024	VT	24450	15.10	26650	4.85	25550	17.80	17550	3.40	800	6
024	HZ	24200	14.90	26650	5.15	25300	17.55	17550	3.70	800	6
030	VT	28350	14.35	31350	4.95	29650	17.05	20650	3.60	950	7
030	HZ	28350	14.45	31350	4.95	29650	17.15	20650	3.60	950	7
036	VT	36350	14.95	37800	4.70	37900	17.30	26400	3.60	1200	9
036	HZ	36350	14.85	37850	4.65	37900	17.30	26450	3.55	1200	9
042	VT	38700	14.55	40050	4.65	40200	16.95	28750	3.50	1400	10
042	HZ	38350	14.30	40250	4.55	40100	16.70	28950	3.40	1400	10
048	VT	46650	13.95	56700	4.65	48750	16.45	38100	3.35	1600	12
048	HZ	46650	13.90	56800	4.65	48000	16.20	38200	3.30	1600	12
060	VT	58500	14.20	77000	4.70	61250	16.50	52050	3.70	1850	15
060	HZ	58900	14.20	66200	4.35	61000	16.25	46000	3.35	1850	15

Greensource i Series Model WQ

Water Source Heat Pump 1.5 to 5 Ton



BOSCH

Physical Data															
Description	Unit	Value													
		018		024		030		036		042		048		060	
		Cu	CuNi	Cu	CuNi	Cu	CuNi	Cu	CuNi	Cu	CuNi	Cu	CuNi	Cu	CuNi
Compressor Type (Qty 1)	—	Rotary		Scroll		Scroll		Scroll		Scroll		Scroll		Scroll	
Max Water Working Pressure	PSIG/kPa	400		400		400		400		400		400		400	
ECM Fan Motor & Blower															
Fan Motor Type/Speeds	—	ECM DecStar		ECM DecStar		ECM DecStar		ECM DecStar		ECM DecStar		ECM DecStar		ECM DecStar	
Fan Motor	HP	0.50		0.50		0.50		0.50		0.50		0.75		0.75	
Blower Wheel Size		9x7		9x7		9x7		9x7		9x7		10x10		10x10	
Water Connection Size															
FPT	Inch	0.75		0.75		0.75		0.75		0.75		1		1	
Coaxial Coil Volume	Gal	0.14		0.24		0.24		0.27		0.27		0.49		0.62	
Vertical Cabinet															
Refrigeration Charge	Oz	23	25	35	33	35	33	44	40	47	52	59			
Air Coil Dimensions (H x W)	Inch	16x16.5		20x16.5		20x16.5		24x20.2		24x20.2		24x26.75		24x26.75	
Standard Filter - 1" Throwaway (L x H)	Inch	16x20		20x20		20x20		24x24		24x24		24x30		24x30	
Optional Filter - 2" MERV 8 or 13 Throwaway (L x H)	Inch	16x20		20x20		20x20		24x24		24x24		24x30		24x30	
Weight - Operating	lbs	173		202		219		247		252		311		337	
Weight - Shipping	lbs	201		230		246		273		279		336		361	
Horizontal Cabinet															
Refrigeration Charge	Oz	24	25	35	33	35	33	40	40	43	42	51	62		
Air Coil Dimensions (H x W)	Inch	16x16.5		16x20.5		16x20.5		18x27.5		18x27.5		20x32		20x32	
Standard Filter - 1" Throwaway (L x H)	Inch	16x20		16x25		16x25		18x30		18x30		20x34.5		20x34.5	
Optional Filter - 2" MERV 8 or 13 Throwaway (L x H)	Inch	16x20		16x25		16x25		18x30		18x30		20x34.5		20x34.5	
Weight - Operating	lbs	174		206		219		244		245		298		318	
Weight - Shipping	lbs	208		233		245		271		271		323		342	

Greensource i Series Model WQ

Water Source Heat Pump 1.5 to 5 Ton



BOSCH

Operating Limits - Cooling & Heating	
Description	Standard Unit
COOLING	
Minimum ambient air temperature °F	50
Maximum ambient air temperature °F	100
Minimum evaporator entering air db/wb °F	68/57
Rated air coil entering air db/wb °F	80/67
Maximum evaporator entering air db/wb °F	95/85
Minimum water coil entering fluid temperature °F	50
Water loop typical coil entering fluid range temperature °F	70/90
Maximum water coil entering fluid temperature °F	110
HEATING	
Minimum ambient air temperature °F	40
Maximum ambient air temperature °F	85
Minimum evaporator entering air db °F	50
Rated air coil entering air °F	68
Maximum evaporator entering air db °F	80
Normal water coil entering fluid range °F	25*-80
Minimum water coil entering Fluid °F	20*

* antifreeze solution is required at these fluid temperatures.



Units are designed to be installed in an air conditioned space. Maximum and minimum conditions may not be combined. Should one value be at the maximum or minimum, the other can not exceed the normal condition.
Maximum and minimum conditions are at rated flow rates.

Greensource i Series Model WQ

Water Source Heat Pump 1.5 to 5 Ton



Electrical Data - ECM EON Constant CFM Blower Motor												
Model	Voltage Code	Voltage/ Hz/ Phase	Voltage Min/Max	Compressor			Blower Motor		Total Unit			
				Qty	RLA	LRA	FLA	HP	Total Unit FLA	Min. Circuit Amps	MOP CALC	MOP
WQ018	1	208-230/1/60	197/253	1	7.4	33	5	0.5	12.4	14.25	21.65	20
WQ024	1	208-230/1/60	197/253	1	13.5	58.3	5.0	0.50	18.5	21.9	35.4	35
WQ030	1	208-230/1/60	197/253	1	12.8	64	5.0	0.50	17.8	21.0	33.8	30
WQ036	1	208-230/1/60	197/253	1	15.4	83.9	5.0	0.50	20.4	24.3	39.7	35
WQ042	1	208-230/1/60	197/253	1	16.7	109	5.0	0.50	21.7	25.9	42.6	40
WQ048	1	208-230/1/60	197/253	1	19.6	130.0	7.3	0.75	26.9	31.8	51.4	50
WQ060	1	208-230/1/60	197/253	1	24.7	166	7.3	0.75	32.0	38.2	62.9	60

Blower Performance CFM															
Model	Motor Speed Tab	Adjust	Default Factory Motor Setting	External Static Pressure (in. of Water)											
				0.10	0.20	0.30	0.40	0.50	0.60	0.70	0.80	0.90	1.00	1.10	1.20
WQ018	A	-		530	550	550	550	550	550	540	530	520	525	-	-
		Normal	X	630	650	650	650	650	650	640	630	610	600	-	-
		+		730	750	750	750	750	750	740	730	720	705	-	-
WQ024	A	-		680	680	680	680	680	680	680	680	655	610	-	-
		Normal	X	780	800	800	800	800	800	800	800	770	720	-	-
		+		890	900	920	920	920	920	920	920	850	820	775	-
WQ030	B	-		805	805	805	805	805	805	805	805	780	725	-	-
		Normal	X	915	930	950	950	950	950	950	880	850	800	-	-
		+		1045	1045	1060	1060	1060	1060	1000	960	890	860	-	-
WQ036	A	-		1020	1020	1020	1020	1020	1020	1020	1020	1020	1020	-	-
		Normal	X	1200	1200	1200	1200	1200	1200	1200	1200	1160	1120	-	-
		+		1380	1380	1380	1380	1380	1380	1330	1290	1250	1215	-	-
WQ042	A	-		1190	1190	1190	1190	1190	1190	1190	1190	1190	1190	1190	-
		Normal	X	1400	1400	1400	1400	1400	1400	1400	1400	1350	1315	1270	-
		+		1555	1555	1570	1570	1570	1535	1500	1460	1415	1375	1330	-
WQ048	A	-		1360	1360	1360	1360	1360	1360	1360	1360	1360	1360	1360	-
		Normal	X	1600	1600	1600	1600	1600	1600	1600	1600	1600	1600	1600	-
		+		1840	1840	1840	1840	1840	1840	1840	1840	1840	1840	1840	-
WQ060 VT	A	-		1575	1575	1575	1575	1575	1575	1575	1575	1575	1575	1575	1575
		Normal	X	1850	1850	1850	1850	1850	1850	1850	1850	1850	1850	1850	1850
		+		2015	2015	2015	2015	2015	2015	2015	2015	2015	2015	1930	1890
WQ060 HZ	A	-		-	1575	1575	1575	1575	1575	1575	1575	1575	1575	1575	1575
		Normal	X	-	-	1850	1850	1850	1850	1850	1850	1850	1850	1850	1850
		+		-	-	-	2015	2015	2015	2015	2015	2015	1920	1885	1840

Note: Air flow is 70% of tabulated values during fan only operation.
 Air flow is 85% of tabulated value during passive dehumidification mode when enabled.

Greensource i Series Model WQ

Water Source Heat Pump 1.5 to 5 Ton



BOSCH

Horizontal Cabinet Corner Weights										
Configuration			Left Hand Evaporator				Right Hand Evaporator			
Model	Unit	Total	Left Front*	Right Front*	Left Back	Right Back	Left Front*	Right Front*	Left Back	Right Back
WQ018	Lbs	177.4	56.9	35.9	47.5	37.1	35.9	56.9	37.1	47.5
	kg	80.5	25.8	16.3	21.5	16.8	16.3	25.8	16.8	21.5
WQ024	Lbs	205.8	56.0	67.4	57.8	24.6	67.4	56.0	24.6	57.8
	kg	93.4	25.4	30.6	26.2	11.2	30.6	25.4	11.2	26.2
WQ030	Lbs	218.8	59.0	71.4	60.8	27.6	71.4	59.0	27.6	60.8
	kg	99.3	26.8	32.4	27.6	12.5	32.4	26.8	12.5	27.6
WQ036	Lbs	244.2	85.8	56.0	42.6	59.8	56.0	85.8	59.8	42.6
	kg	110.9	39.0	25.4	19.3	27.1	25.4	39.0	27.1	19.3
WQ042	Lbs	244.8	86.8	69.8	37.8	50.4	69.8	86.8	50.4	37.8
	kg	111.1	39.4	31.7	17.2	22.9	31.7	39.4	22.9	17.2
WQ048	Lbs	298.2	110.4	74.8	91.6	21.4	74.8	110.4	21.4	91.6
	kg	135.4	50.1	34.0	41.6	9.7	34.0	50.1	9.7	41.6
WQ060	Lbs	318.2	111.4	80.0	99.3	27.5	80.0	111.4	27.5	99.3
	kg	144.5	50.6	36.3	45.1	12.5	36.3	50.6	12.5	45.1

*Front is control box end

Vertical Unit Configurations

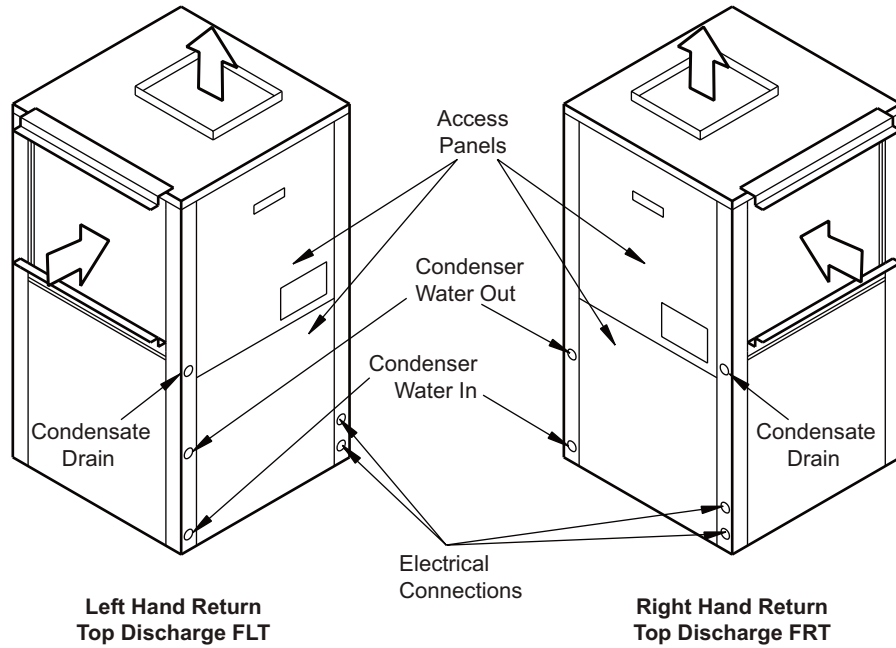

Horizontal Unit Configurations

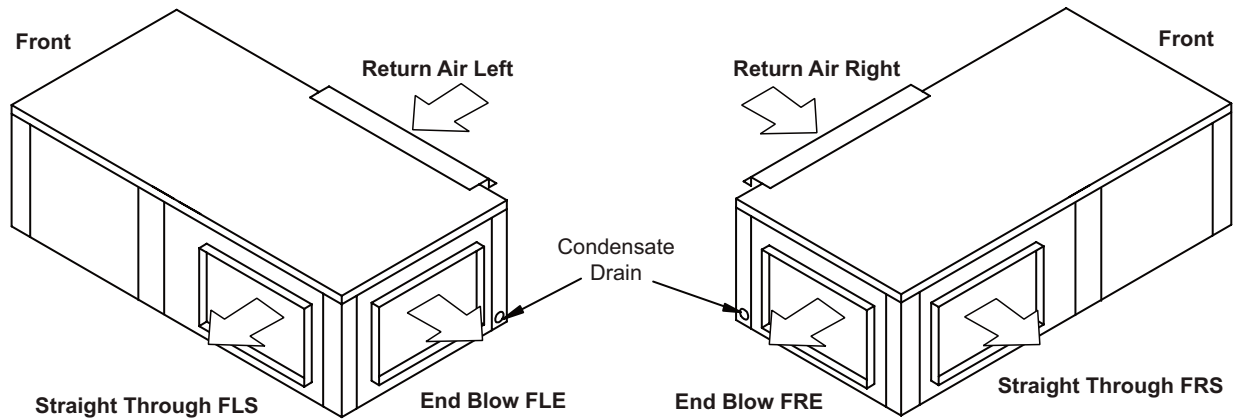

Greensource i Series Model WQ

Water Source Heat Pump 1.5 to 5 Ton



WQ Vertical Unit Dimensions and Connections

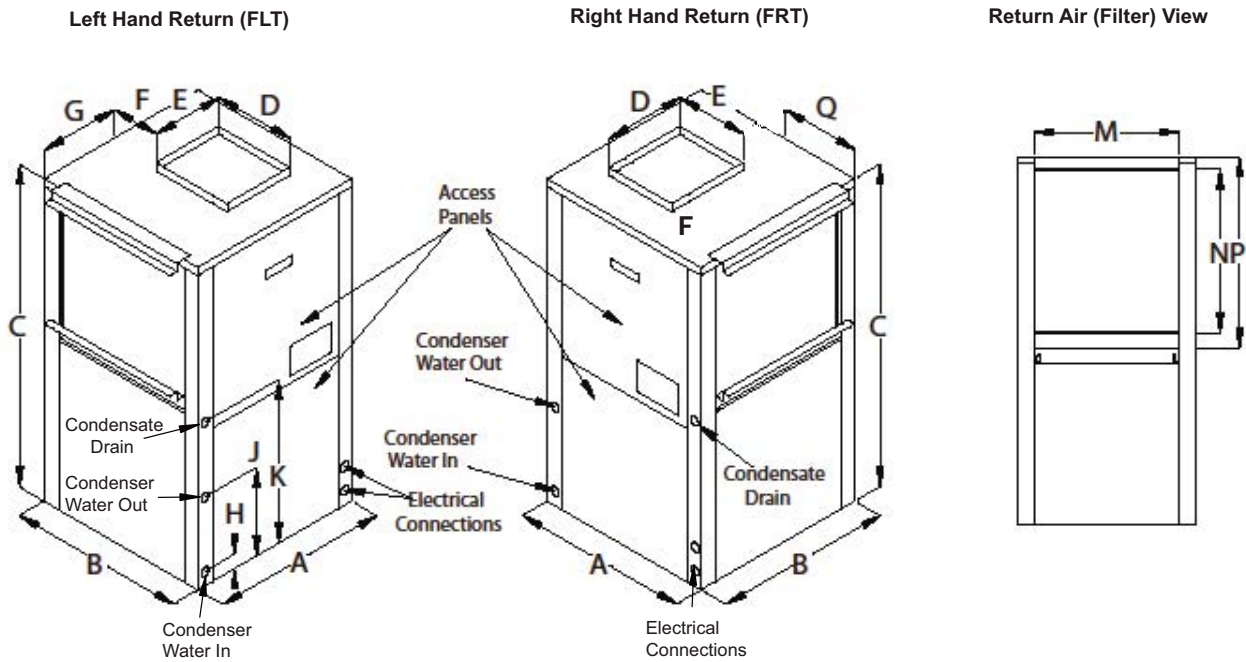

WQ Vertical Unit Dimensions

Model	A Width	B Depth	C Height	D Discharge Depth	E Discharge Width	F Cabinet Edge to Discharge	G Left Side to Discharge	H Water Inlet	J Water Outlet	K Condensate Drain	M R/A Duct Width	N R/A Duct Flange Height	P Filter Rack Height	Q	Condenser Water Connections	Recommended Replacement Nominal Filter Size
WQ018	21.5	21.5	32.25	14.0	14.0	3.1	5.2	2.85	8.45	15.87	20.0	14.0	16.0	5.2	3/4" FPT	16 × 20 × 1
WQ024	21.5	21.5	39.25	14.0	16.0	3.8	0.6	2.80	8.45	18.87	20.0	18.0	20.0	4.9	3/4" FPT	20 × 20 × 1
WQ030	21.5	21.5	39.25	14.0	16.0	3.8	0.6	2.80	8.45	18.87	20.0	18.0	20.0	4.9	3/4" FPT	20 × 20 × 1
WQ036	21.5	26.0	43.25	14.0	16.0	6.0	0.6	2.75	10.77	18.87	24.0	22.0	24.0	4.9	3/4" FPT	24 × 24 × 1
WQ042	21.5	26.0	44.25	14.0	16.0	6.0	0.6	2.75	10.77	18.87	24.0	22.0	24.0	4.9	3/4" FPT	24 × 24 × 1
WQ048	24.0	32.5	45.25	18.0	16.0	7.3	0.8	3.26	13.20	20.87	30.0	22.0	24.0	7.3	1" FPT	24 × 30 × 1
WQ060	24.0	32.5	45.25	18.0	16.0	7.3	0.8	3.26	13.20	20.87	30.0	22.0	24.0	7.3	1" FPT	24 × 30 × 1

All dimensions within $\pm 0.125"$. All condensate drain connections are 3/4" FPT. Specifications subject to change without notice. 1" filter rack extends 1.23" beyond the side of the unit. 2" filter rack extends 2.89" beyond the side of the unit. The 2" filter rack is 4 sided with a filter access door on one end and can accept either a 1" or 2" filter.

Greensource i Series Model WQ

Water Source Heat Pump 1.5 to 5 Ton



WQ Horizontal Unit Dimensions and Connections

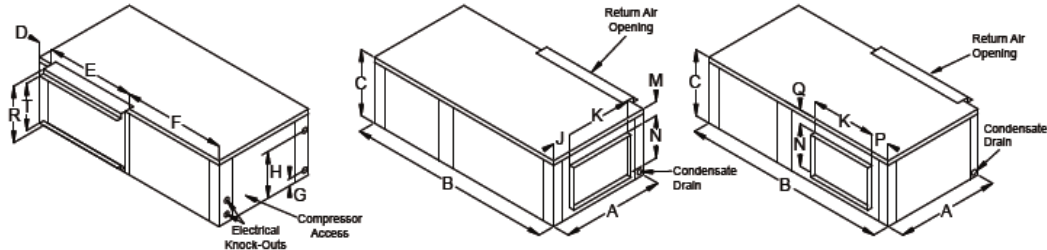

Left Hand Return End Blow (FLE)

Left Hand Return Straight Through (FLS)

NOTE: Models WQ48 & 060 Left Hand Return units have condenser water connections on the front right and electrical knockouts on the front left.

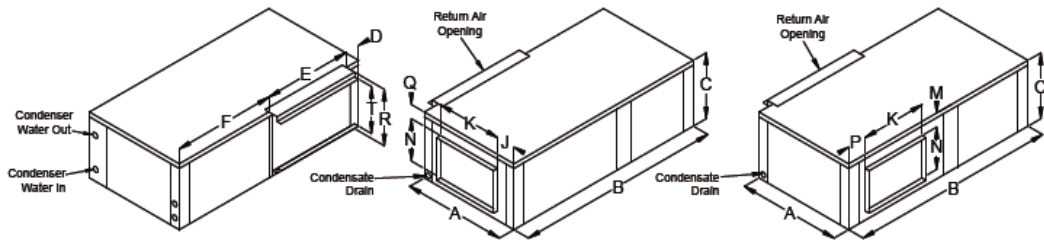

Right Hand Return End Blow (FRE)

Right Hand Return Straight Through (FRS)

WQ Horizontal Left Hand Unit Dimensions

Model	A	B	C	D	E	F	G	H	J	K	M	N	P	Q	R	T	Condenser Water Connections	Recommended Replacement Nominal Filter Size
	Width	Depth	Height	Cabinet End to Filter Rack	R/A Duct Width	Cab Front to Filter Rack	Water Inlet	Water Outlet	Side to Discharge (End)	Discharge Width	Top to Discharge (FLE & FRS)	Discharge Height	End to Discharge (Straight)	Top to Discharge (FRE & FLS)	Filter Rack Height	R/A Duct Flange Height		
WQ018	22.0	43.0	17.0	1.5	20.2	21.4	2.86	14.13	5.42	9.13	6.11	9.65	4.92	1.23	16.8	15.0	3/4" FPT	16 × 20 × 1
WQ024	22.0	43.0	18.0	1.5	25.0	16.5	2.86	14.13	5.44	9.13	1.25	6.85	4.93	9.80	16.8	15.0	3/4" FPT	16 × 25 × 1
WQ030	22.0	43.0	18.0	1.5	25.0	16.5	2.86	14.1	5.44	9.13	1.25	6.85	4.93	9.80	16.8	15.0	3/4" FPT	16 × 25 × 1
WQ036	22.0	54.5	19.0	1.5	30.15	22.86	2.86	16.13	7.43	9.13	1.7	6.85	4.94	10.30	18.8	18.3	3/4" FPT	18 × 30 × 1
WQ042	22.0	54.5	19.0	1.5	30.11	22.86	2.86	18.52	5.44	9.13	1.9	6.85	4.94	10.30	18.8	16.4	3/4" FPT	18 × 30 × 1
WQ048	25.0	54.5	21.0	1.5	34.6	18.4	2.86	18.52	4.30	13.22	1.50	9.31	3.71	10.19	20.7	18.4	1" FPT	20 × 34.5 × 5 × 1
WQ060	25.0	54.5	21.0	1.5	34.6	18.4	2.86	18.52	6.32	11.76	7.16	12.5	5.82	1.68	20.6	18.4	1" FPT	20 × 34.5 × 5 × 1

WQ Horizontal Right Hand Unit Dimensions

WQ018	22.0	43.0	17.0	1.5	20.2	21.4	2.86	14.13	5.42	9.13	6.11	9.65	4.92	1.23	16.8	15.0	3/4" FPT	16 × 20 × 1
WQ024	22.0	43.0	18.0	1.5	25.0	16.5	2.47	15.00	5.43	9.13	9.79	6.85	4.93	1.36	16.7	16.3	3/4" FPT	16 × 25 × 1
WQ030	22.0	43.0	18.0	1.5	25.0	16.5	2.47	15.0	5.43	9.13	9.79	6.85	4.93	1.36	16.7	16.3	3/4" FPT	16 × 25 × 1
WQ036	22.0	54.5	19.0	1.5	30.15	22.86	2.86	16.13	5.43	9.13	10.3	6.85	4.83	1.75	18.8	17.0	3/4" FPT	18 × 30 × 1
WQ042	22.0	54.5	19.0	1.5	30.15	22.85	2.86	16.13	5.30	9.13	10.30	6.9	4.93	1.86	18.8	17.0	3/4" FPT	18 × 30 × 1
WQ048	25.0	54.5	21.0	1.5	34.6	18.4	2.86	18.52	5.48	13.22	10.19	9.31	4.98	1.50	20.2	18.4	1" FPT	20 × 34.5 × 5 × 1
WQ060	25.0	54.5	21.0	1.5	34.6	18.4	2.86	18.52	5.48	13.22	10.19	9.3	4.98	1.50	20.2	18.4	1" FPT	20 × 34.5 × 5 × 1

NOTES: All dimensions within $\pm 0.125"$. All condensate drain connections are 3/4" FPT. QV / WQ015-070 can be field converted between end blow and straight through supply air configurations. Specifications subject to change without notice. 1" filter rack extends 1.23" beyond the side of the unit. 2" filter rack extends 2.89" beyond the side of the unit. The 2" filter rack is 4 sided with a filter access door on one end and can accept either a 1" or 2" filter.

Greensource i Series Model WQ

Water Source Heat Pump 1.5 to 5 Ton



Capacity Data WQ018 (650 CFM)															
Cooling									Heating						
Entering Water Temp (°F)	Water flow (GPM)	Pressure Drop PSI	Entering Air Temp DB/WB (°F)	Total Capacity (MBTUH)	Sensible Capacity (MBTUH)	Heat of Rejection (MBTUH)	Power Input (kW)	EER	Entering Fluid Temp (°F)	Pressure Drop PSI	Entering Air Temp (°F)	Total Capacity (MBTUH)	Heat of Absorption (MBTUH)	Power Input (kW)	COP
50	2.5	1.3	75/63	19.7	15.5	23.4	1.1	17.9	30	1.3	60	13.7	10.4	1.1	3.6
			80/67	20.9	16.1	24.5	1.1	19.4			70	13.3	9.8	1.2	3.3
			85/71	22.2	16.5	25.8	1.1	21.1			80	13.0	9.2	1.2	3.1
	3.8	2.6	75/63	19.9	15.7	23.6	1.1	18.2		60	14.2	10.8	1.1	3.6	
			80/67	21.3	16.2	24.9	1.1	19.9		70	13.7	10.2	1.2	3.4	
			85/71	22.7	16.6	26.2	1.0	21.9		80	13.4	9.6	1.3	3.1	
	5.0	4.2	75/63	20.0	16.2	23.8	1.1	18.2		60	14.4	11.0	1.1	3.7	
			80/67	21.4	16.3	25.0	1.1	20.1		70	14.0	10.4	1.2	3.4	
			85/71	22.8	16.6	26.3	1.0	22.1		80	13.6	9.8	1.3	3.1	
60	2.5	1.2	75/63	18.8	15.3	22.6	1.1	16.4	40	1.3	60	15.6	12.2	1.2	3.9
			80/67	20.0	15.7	23.8	1.1	17.6			70	15.2	11.6	1.2	3.6
			85/71	21.3	16.1	25.0	1.1	19.0			80	14.8	10.9	1.3	3.3
	3.8	2.5	75/63	19.1	15.4	22.8	1.1	16.9		60	16.2	12.7	1.2	4.0	
			80/67	20.4	15.8	24.1	1.1	18.4		70	15.8	12.1	1.2	3.7	
			85/71	21.7	16.2	25.3	1.1	20.0		80	15.4	11.4	1.3	3.4	
	5.0	4.2	75/63	19.1	14.7	22.8	1.1	16.8		60	16.5	13.1	1.2	4.1	
			80/67	20.5	15.8	24.2	1.1	18.6		70	16.1	12.4	1.2	3.8	
			85/71	21.8	16.1	25.4	1.1	20.3		80	15.6	11.7	1.3	3.5	
70	2.5	1.2	75/63	17.9	14.8	22.0	1.2	14.6	50	1.3	60	17.6	14.1	1.2	4.3
			80/67	19.1	15.3	23.1	1.2	15.6			70	17.2	13.5	1.3	4.0
			85/71	20.3	15.7	24.3	1.2	16.6			80	16.9	12.8	1.3	3.7
	3.8	2.5	75/63	18.1	14.5	22.1	1.2	14.8		60	18.4	14.9	1.2	4.5	
			80/67	19.4	15.6	23.3	1.2	16.3		70	17.9	14.1	1.3	4.1	
			85/71	20.6	15.9	24.6	1.2	17.5		80	17.5	13.4	1.4	3.8	
	5.0	4.1	75/63	18.2	14.5	22.2	1.2	15.0		60	18.8	15.2	1.2	4.6	
			80/67	19.4	14.8	23.4	1.2	16.1		70	18.3	14.5	1.3	4.2	
			85/71	20.6	15.2	24.5	1.2	17.1		80	17.9	13.7	1.4	3.8	
80	2.5	1.2	75/63	17.0	14.6	21.4	1.3	12.7	60	1.3	60	19.7	16.2	1.2	4.8
			80/67	18.1	14.9	22.6	1.3	13.5			70	19.3	15.5	1.3	4.4
			85/71	19.2	15.5	23.7	1.4	14.2			80	18.9	14.7	1.4	4.0
	3.8	2.4	75/63	17.2	14.1	21.5	1.3	12.9		60	20.7	17.2	1.2	5.1	
			80/67	18.4	15.1	22.7	1.3	14.1		70	20.1	16.3	1.3	4.6	
			85/71	19.5	15.7	23.9	1.3	15.0		80	19.6	15.5	1.4	4.1	
	5.0	4.0	75/63	17.3	14.1	21.6	1.3	13.1		60	21.1	17.6	1.2	5.2	
			80/67	18.5	14.5	22.8	1.3	13.9		70	20.6	16.7	1.3	4.7	
			85/71	19.6	16.3	24.0	1.3	15.6		80	20.1	15.9	1.4	4.2	
90	2.5	1.1	75/63	16.1	14.1	20.9	1.5	10.9	70	1.2	60	21.9	18.4	1.2	5.4
			80/67	17.1	14.7	22.0	1.5	11.5			70	21.4	17.6	1.3	4.9
			85/71	18.2	15.1	23.2	1.5	12.2			80	21.0	16.8	1.4	4.4
	3.8	2.3	75/63	16.3	13.8	21.0	1.5	11.1		60	22.9	19.5	1.2	5.6	
			80/67	17.4	14.8	22.2	1.4	12.0		70	22.4	18.6	1.3	5.1	
			85/71	18.5	15.5	23.4	1.4	12.9		80	21.9	17.6	1.4	4.5	
	5.0	3.9	75/63	16.4	13.8	21.1	1.5	11.3		60	23.5	20.1	1.2	5.8	
			80/67	17.5	14.1	22.2	1.5	12.0		70	22.9	19.1	1.3	5.2	
			85/71	18.7	14.4	23.4	1.5	12.7		80	22.4	18.1	1.4	4.6	
100	2.5	1.1	75/63	15.1	13.8	20.4	1.6	9.3	80	1.2	60	24.1	20.7	1.2	5.9
			80/67	16.2	14.4	21.5	1.6	9.9			70	23.6	19.8	1.3	5.3
			85/71	17.2	14.9	22.7	1.6	10.4			80	23.1	18.8	1.4	4.7
	3.8	2.3	75/63	15.3	14.3	20.5	1.6	9.8		60	25.3	21.9	1.2	6.2	
			80/67	16.4	14.9	21.6	1.6	10.4		70	24.8	20.9	1.3	5.5	
			85/71	17.5	15.0	22.8	1.6	10.9		80	24.2	19.9	1.5	4.8	
	5.0	3.9	75/63	15.5	13.4	20.6	1.6	9.7		60	26.0	22.6	1.2	6.4	
			80/67	16.5	15.0	21.7	1.5	10.7		70	25.4	21.5	1.3	5.6	
			85/71	17.6	15.6	22.8	1.5	11.4		80	24.8	20.4	1.5	4.9	
110	2.5	1.1	75/63	14.2	13.2	19.9	1.8	8.0	Extended Range - Anti-freeze required	1.2	60	24.1	20.7	1.2	5.9
			80/67	15.2	13.8	21.0	1.8	8.4			70	23.6	19.8	1.3	5.3
			85/71	16.2	14.2	22.1	1.8	8.9			80	23.1	18.8	1.4	4.7
	3.8	2.3	75/63	14.4	13.3	20.0	1.7	8.2		60	25.3	21.9	1.2	6.2	
			80/67	15.4	14.2	21.1	1.7	8.8		70	24.8	20.9	1.3	5.5	
			85/71	16.4	14.2	22.3	1.8	9.2		80	24.2	19.9	1.5	4.8	
	5.0	3.8	75/63	14.4	13.5	20.0	1.7	8.2		60	26.0	22.6	1.2	6.4	
			80/67	15.3	14.1	21.1	1.8	8.7		70	25.4	21.5	1.3	5.6	
			85/71	16.5	15.1	22.3	1.7	9.5		80	24.8	20.4	1.5	4.9	

Extended Range - Anti-freeze required
 AHR/ISO13256-1 certified performance is rated at entering air conditions of 80.6°F DB and 66.2°F WB in cooling and 68°F DB in heating.
 Tabulated unit performance does not include fan or pump power corrections required for AHR/ISO standard performance ratings.
 Unit performance may be interpolated. Extrapolation is not allowed.
 For conditions other than rating conditions provided, consult the BST selection software.
 Ratings below 40°F are with a methanol solution.

DISCLAIMER: The performance reported herein is based on testing by FHP. Variations in the installation and operational environment may alter performance. Bosch disclaims all warranties, express and implied, that the performance will be as reported, including the warranty of merchantability and fitness for purpose. In addition, continuous research and development may result in a change to an appliances design and specifications at the time of order, which Bosch may change without notice. Before purchase, confirm the design specifications of the appliance.

Greensource i Series Model WQ

Water Source Heat Pump 1.5 to 5 Ton



BOSCH

Capacity Data WQ024 (800 CFM)															
Cooling									Heating						
Entering Water Temp (°F)	Water flow (GPM)	Pressure Drop PSI	Entering Air Temp DB/WB (°F)	Total Capacity (MBTUH)	Sensible Capacity (MBTUH)	Heat of Rejection (MBTUH)	Power Input (kW)	EER	Entering Fluid Temp (°F)	Pressure Drop PSI	Entering Air Temp (°F)	Total Capacity (MBTUH)	Heat of Absorption (MBTUH)	Power Input (kW)	COP
50	3	1.2	75/63	26.4	20.1	30.3	1.1	23.4	30	1.3	60	17.3	13.3	1.3	3.8
			80/67	28.1	20.7	32.0	1.1	24.6			70	17.1	12.6	1.5	3.4
			85/71	29.8	21.2	33.8	1.2	25.9			80	16.9	11.8	1.6	3.0
	4.5	2.5	75/63	27.1	20.3	30.7	1.1	25.8		60	18.2	14.2	1.3	4.0	
			80/67	28.8	21.0	32.5	1.0	27.5		70	17.9	13.4	1.5	3.5	
			85/71	30.7	21.5	34.3	1.1	29.2		80	17.6	12.5	1.7	3.1	
	6	4.2	75/63	27.1	20.1	30.7	1.1	25.6		60	18.7	14.6	1.4	4.0	
			80/67	29.2	21.2	32.7	1.0	29.0		70	18.3	13.8	1.5	3.6	
			85/71	31.1	21.6	34.6	1.0	30.9		80	18.0	12.9	1.7	3.2	
60	3	1.2	75/63	25.3	19.6	29.6	1.3	19.9	40	1.3	60	19.7	15.3	1.4	4.2
			80/67	27.0	20.2	31.3	1.3	21.0			70	19.4	14.7	1.5	3.7
			85/71	28.6	20.7	33.0	1.3	22.0			80	19.2	13.9	1.7	3.3
	4.5	2.5	75/63	25.9	19.8	30.0	1.2	21.6		60	20.7	16.5	1.4	4.4	
			80/67	27.6	20.6	31.7	1.2	23.1		70	20.3	15.7	1.5	3.9	
			85/71	29.4	21.0	33.5	1.2	24.4		80	20.0	14.8	1.7	3.4	
	6	4.1	75/63	26.0	19.7	30.1	1.2	21.8		60	21.3	17.2	1.4	4.5	
			80/67	27.7	20.1	31.8	1.2	23.0		70	20.9	16.2	1.6	3.9	
			85/71	29.8	20.9	33.8	1.2	25.4		80	20.5	15.3	1.7	3.5	
70	3	1.2	75/63	24.2	19.2	28.9	1.4	17.0	50	1.1	60	22.3	17.4	1.4	4.6
			80/67	25.7	19.8	30.6	1.4	17.9			70	21.8	17.0	1.6	4.1
			85/71	27.4	20.3	32.3	1.5	18.8			80	21.7	16.2	1.8	3.6
	4.5	2.4	75/63	24.7	19.3	29.3	1.4	18.3		60	23.4	19.0	1.4	4.8	
			80/67	26.4	19.9	31.0	1.4	19.5		70	23.2	18.2	1.6	4.2	
			85/71	28.1	20.5	32.7	1.4	20.6		80	22.8	17.2	1.8	3.8	
	6	4.0	75/63	25.0	19.8	29.4	1.3	19.3		60	24.1	19.9	1.5	4.9	
			80/67	26.5	19.7	31.0	1.4	19.6		70	23.9	18.8	1.6	4.4	
			85/71	28.4	20.7	32.9	1.3	21.5		80	23.4	17.8	1.8	3.8	
80	3	1.2	75/63	23.0	18.7	28.3	1.6	14.6	60	1.0	60	24.5	20.1	1.5	4.9
			80/67	24.5	19.3	29.9	1.6	15.3			70	24.4	19.3	1.6	4.4
			85/71	26.1	19.9	31.5	1.6	16.1			80	24.5	18.7	1.8	4.0
	4.5	2.4	75/63	23.5	18.9	28.6	1.5	15.6		60	26.5	21.9	1.5	5.2	
			80/67	25.1	19.4	30.2	1.5	16.4		70	26.1	20.9	1.6	4.7	
			85/71	26.8	20.0	31.9	1.5	17.4		80	25.8	20.0	1.8	4.2	
	6	3.9	75/63	23.6	18.9	28.6	1.5	15.7		60	27.3	22.8	1.5	5.4	
			80/67	25.4	19.9	30.4	1.5	17.2		70	26.8	22.0	1.7	4.7	
			85/71	27.0	20.7	32.1	1.5	18.3		80	26.5	20.7	1.8	4.2	
90	3	1.1	75/63	21.8	18.2	27.7	1.8	12.4	70	1.0	60	28.0	23.4	1.5	5.4
			80/67	23.2	18.9	29.2	1.8	13.1			70	27.2	21.9	1.7	4.8
			85/71	24.7	19.5	30.7	1.8	13.7			80	27.2	21.5	1.8	4.3
	4.5	2.2	75/63	22.3	18.5	27.9	1.7	13.2		60	29.9	25.5	1.5	5.7	
			80/67	23.8	19.0	29.4	1.7	13.9		70	29.2	23.9	1.7	5.0	
			85/71	25.4	19.6	31.1	1.7	14.8		80	28.8	22.7	1.9	4.5	
	6	3.7	75/63	22.4	18.5	28.0	1.7	13.4		60	30.5	25.8	1.5	5.8	
			80/67	24.0	19.4	29.6	1.7	14.5		70	30.1	24.8	1.7	5.1	
			85/71	25.5	19.4	31.2	1.7	15.0		80	29.5	23.9	1.9	4.6	
100	3	1.1	75/63	20.6	17.8	27.1	2.0	10.5	80	1.0	60	30.9	26.1	1.6	5.8
			80/67	22.0	18.3	28.6	2.0	11.1			70	30.5	25.2	1.7	5.2
			85/71	23.4	19.0	30.1	2.0	11.7			80	30.2	24.3	1.9	4.6
	4.5	2.2	75/63	20.9	17.9	27.2	1.9	11.0		60	33.1	28.6	1.6	6.1	
			80/67	22.4	18.3	28.8	1.9	11.7		70	32.5	27.0	1.8	5.4	
			85/71	23.9	19.2	30.3	1.9	12.5		80	31.9	26.1	2.0	4.8	
	6	3.7	75/63	21.2	18.0	27.4	1.9	11.4		60	34.3	28.9	1.6	6.2	
			80/67	22.6	18.7	28.9	1.9	12.1		70	33.6	28.0	1.8	5.5	
			85/71	24.2	19.2	30.4	1.9	12.8		80	32.9	26.7	2.0	4.9	
110	3	1.1	75/63	19.3	17.3	26.5	2.2	8.8	Extended Range - Anti-freeze required	1.1	60	32.9	26.7	2.0	4.9
			80/67	20.7	17.8	28.0	2.2	9.3			70	32.9	26.7	2.0	4.9
			85/71	22.1	18.4	29.4	2.2	9.9			80	32.9	26.7	2.0	4.9
	4.5	2.2	75/63	19.8	17.4	26.7	2.1	9.3		60	35.3	30.1	1.6	6.5	
			80/67	21.1	18.0	28.2	2.1	9.9		70	34.9	29.7	1.8	5.9	
			85/71	22.5	18.6	29.6	2.2	10.5		80	34.5	29.3	2.0	5.3	
	6	3.6	75/63	20.1	17.5	26.8	2.1	9.7		60	37.7	32.9	1.6	7.1	
			80/67	21.4	18.1	28.3	2.1	10.3		70	37.3	32.5	1.8	6.5	
			85/71	22.9	18.8	29.8	2.1	11.0		80	36.9	32.1	2.0	5.9	

Extended Range - Anti-freeze required

AHRI/ISO13256-1 certified performance is rated at entering air conditions of 80.6°F DB and 66.2°F WB in cooling and 68°F DB in heating.

Tabulated unit performance does not include fan or pump power corrections required for AHRI/ISO standard performance ratings.

Unit performance may be interpolated. Extrapolation is not allowed.

For conditions other than rating conditions provided, consult the BST selection software.

Ratings below 40°F are with a methanol solution.

DISCLAIMER: The performance reported herein is based on testing by FHP. Variations in the installation and operational environment may alter performance. Bosch disclaims all warranties, express and implied, that the performance will be as reported, including the warranty of merchantability and fitness for purpose. In addition, continuous research and development may result in a change to an appliances design and specifications at the time of order, which Bosch may change without notice. Before purchase, confirm the design specifications of the appliance.

Greensource i Series Model WQ

Water Source Heat Pump 1.5 to 5 Ton



Capacity Data WQ030 (950 CFM)

Cooling										Heating						
Entering Water Temp (°F)	Water flow (GPM)	Pressure Drop PSI	Entering Air Temp DB/WB (°F)	Total Capacity (MBTUH)	Sensible Capacity (MBTUH)	Heat of Rejection (MBTUH)	Power (kW)	EER	Entering Fluid Temp (°F)	Pressure Drop PSI	Entering Air Temp (°F)	Total Capacity (MBTUH)	Heat of Absorption (MBTUH)	Power Input (kW)	COP	
50	3.8	1.8	75/63	32.1	24.2	37.2	1.5	21.7	30	1.6	60	20.6	15.4	1.6	3.7	
			80/67	34.2	24.9	39.3	1.5	23.1				70	20.5	14.6	1.8	3.3
			85/71	36.3	25.6	41.4	1.5	24.6				80	20.3	14.0	2.0	3.0
	6.3	4.4	75/63	33.0	24.9	37.8	1.4	24.1		4.1	60	22.2	16.7	1.7	3.9	
			80/67	35.3	25.3	40.0	1.4	25.7				70	21.7	16.0	1.9	3.4
			85/71	37.5	26.1	42.2	1.4	27.6				80	21.4	14.9	2.1	3.1
	7.5	6.1	75/63	32.9	23.8	37.7	1.4	23.1		5.6	60	22.4	17.2	1.7	3.9	
			80/67	35.5	25.8	40.1	1.3	26.6				70	22.1	16.3	1.9	3.5
			85/71	37.7	26.5	42.4	1.3	28.5				80	21.7	15.2	2.1	3.1
60	3.8	1.7	75/63	30.8	23.8	36.3	1.6	18.9	40	1.6	60	23.4	17.7	1.7	4.0	
			80/67	32.8	24.5	38.4	1.6	20.1				70	22.9	16.6	1.9	3.6
			85/71	34.9	25.1	40.5	1.6	21.4				80	23.0	16.2	2.1	3.2
	6.3	4.3	75/63	31.7	24.1	36.9	1.5	20.7		4.0	60	24.6	19.5	1.7	4.2	
			80/67	33.8	24.8	39.0	1.5	22.2				70	24.5	18.5	1.9	3.7
			85/71	36.0	25.5	41.2	1.5	23.8				80	24.4	17.6	2.1	3.3
	7.5	6.0	75/63	31.6	23.3	36.8	1.6	20.1		5.5	60	25.7	19.9	1.7	4.3	
			80/67	34.0	24.9	39.1	1.5	22.7				70	25.1	18.9	1.9	3.8
			85/71	36.3	25.6	41.4	1.5	24.4				80	24.6	18.0	2.1	3.4
70	3.8	1.7	75/63	29.4	23.2	35.5	1.8	16.3	50	1.8	60	26.2	20.7	1.8	4.4	
			80/67	31.4	23.9	37.5	1.8	17.4				70	26.3	20.2	1.9	4.0
			85/71	33.4	24.6	39.6	1.8	18.6				80	25.7	19.0	2.1	3.5
	6.3	4.2	75/63	30.0	22.7	35.8	1.8	17.0		4.4	60	25.6	24.3	1.7	4.3	
			80/67	32.3	24.5	38.0	1.7	19.2				70	27.4	20.9	2.0	4.1
			85/71	34.5	24.7	40.2	1.7	20.4				80	27.5	20.6	2.2	3.7
	7.5	5.9	75/63	30.2	22.8	36.0	1.7	17.5		6.1	60	28.4	22.8	1.8	4.6	
			80/67	32.3	23.4	38.1	1.7	18.8				70	28.2	22.4	2.0	4.2
			85/71	34.7	25.0	40.4	1.7	21.0				80	28.1	21.0	2.2	3.8
80	3.8	1.7	75/63	28.0	22.6	34.7	2.0	14.0	60	1.7	60	30.3	24.7	1.8	4.9	
			80/67	29.9	23.3	36.7	2.0	15.0				70	29.0	22.7	2.0	4.3
			85/71	31.9	24.1	38.7	2.0	16.0				80	28.6	21.4	2.2	3.8
	6.3	4.2	75/63	28.6	22.2	35.0	1.9	14.7		4.3	60	31.6	25.6	1.8	5.0	
			80/67	30.6	22.8	37.0	1.9	15.8				70	31.0	24.5	2.0	4.5
			85/71	32.9	23.8	39.2	1.9	17.3				80	31.0	23.9	2.2	4.1
	7.5	5.8	75/63	28.8	22.3	35.2	1.9	15.1		6.0	60	32.7	27.3	1.9	5.2	
			80/67	30.9	22.9	37.2	1.9	16.2				70	31.4	25.3	2.0	4.5
			85/71	33.0	23.5	39.3	1.9	17.4				80	31.7	24.7	2.2	4.1
90	3.8	1.6	75/63	26.6	22.0	34.0	2.2	12.0	70	1.7	60	33.2	27.7	1.9	5.2	
			80/67	28.5	22.6	35.9	2.2	12.8				70	32.7	25.9	2.0	4.7
			85/71	30.4	23.3	37.9	2.2	13.7				80	31.9	24.8	2.3	4.2
	6.3	4.1	75/63	27.2	22.3	34.3	2.1	12.9		4.2	60	35.4	30.2	1.9	5.5	
			80/67	29.2	23.0	36.3	2.1	13.9				70	35.2	28.9	2.1	5.0
			85/71	31.2	24.2	38.3	2.1	15.0				80	34.9	27.4	2.3	4.5
	7.5	5.7	75/63	27.4	22.5	34.4	2.1	13.1		5.9	60	36.1	30.4	1.9	5.6	
			80/67	29.4	23.4	36.4	2.1	14.2				70	35.9	29.5	2.1	5.0
			85/71	31.4	24.3	38.4	2.1	15.3				80	35.5	27.7	2.3	4.5
100	3.8	1.6	75/63	25.2	21.3	33.4	2.5	10.2	80	1.7	60	37.0	31.5	1.9	5.7	
			80/67	27.0	22.1	35.2	2.5	10.9				70	36.2	29.9	2.1	5.1
			85/71	28.8	22.8	37.1	2.5	11.6				80	35.5	28.2	2.3	4.5
	6.3	4.0	75/63	25.7	21.3	33.6	2.4	10.8		4.2	60	39.5	33.7	1.9	6.0	
			80/67	27.6	22.6	35.5	2.4	11.7				70	39.7	31.9	2.1	5.5
			85/71	29.5	23.2	37.4	2.4	12.5				80	37.6	30.8	2.3	4.7
	7.5	5.5	75/63	25.8	21.6	33.6	2.4	10.9		5.8	60	41.0	34.9	1.9	6.2	
			80/67	27.6	22.3	35.5	2.4	11.7				70	39.4	32.3	2.1	5.4
			85/71	29.7	22.7	37.5	2.4	12.6				80	39.4	31.1	2.3	4.9
110	3.8	1.6	75/63	23.7	20.8	32.9	2.8	8.6	Extended Range - Anti-freeze required	1.7	60	37.0	31.5	1.9	5.7	
			80/67	25.4	21.5	34.6	2.8	9.2				70	36.2	29.9	2.1	5.1
			85/71	27.2	22.2	36.4	2.8	9.8				80	35.5	28.2	2.3	4.5
	6.3	3.9	75/63	24.2	21.0	33.0	2.7	9.1		4.2	60	39.5	33.7	1.9	6.0	
			80/67	26.0	21.7	34.8	2.7	9.7				70	39.7	31.9	2.1	5.5
			85/71	27.7	22.4	36.7	2.7	10.4				80	37.6	30.8	2.3	4.7
	7.5	5.5	75/63	24.3	21.1	33.1	2.6	9.2		5.8	60	41.0	34.9	1.9	6.2	
			80/67	26.1	21.9	34.9	2.6	9.9				70	39.4	32.3	2.1	5.4
			85/71	28.0	22.5	36.8	2.6	10.7				80	39.4	31.1	2.3	4.9

Extended Range - Anti-freeze required
 AHR/ISO13256-1 certified performance is rated at entering air conditions of 80.6°F DB and 66.2°F WB in cooling and 68°F DB in heating.
 Tabulated unit performance does not include fan or pump power corrections required for AHR/ISO standard performance ratings.
 Unit performance may be interpolated. Extrapolation is not allowed.
 For conditions other than rating conditions provided, consult the BST selection software.
 Ratings below 40°F are with a methanol solution.
DISCLAIMER: The performance reported herein is based on testing by FHP. Variations in the installation and operational environment may alter performance. Bosch disclaims all warranties, express and implied, that the performance will be as reported, including the warranty of merchantability and fitness for purpose. In addition, continuous research and development may result in a change to an appliances design and specifications at the time of order, which Bosch may change without notice. Before purchase, confirm the design specifications of the appliance.

Greensource i Series Model WQ

Water Source Heat Pump 1.5 to 5 Ton



BOSCH

Capacity Data WQ036 (1200 CFM)															
Cooling									Heating						
Entering Water Temp (°F)	Water flow (GPM)	Pressure Drop (PSI)	Entering Air Temp DB/WB (°F)	Total Capacity (MBTUH)	Sensible Capacity (MBTUH)	Heat of Rejection (MBTUH)	Power (kW)	EER	Entering Fluid Temp (°F)	Pressure Drop (PSI)	Entering Air Temp (°F)	Total Capacity (MBTUH)	Heat of Absorption (MBTUH)	Power Input (kW)	COP
50	4.5	1.5	75/63	40.1	30.6	46.1	1.8	22.9	30	1.7	60	25.4	19.6	1.9	4.0
			80/67	42.9	31.5	48.9	1.8	24.4			70	24.9	18.4	2.1	3.5
			85/71	45.7	32.4	51.7	1.8	25.9			80	24.6	17.1	2.4	3.1
	6	2.6	75/63	40.7	31.1	46.4	1.7	24.3		60	26.1	20.2	1.9	4.1	
			80/67	43.5	32.0	49.2	1.7	26.0		70	25.5	18.9	2.1	3.5	
			85/71	46.5	32.5	52.2	1.7	27.7		80	25.1	17.6	2.4	3.1	
	9	5.2	75/63	41.3	31.0	46.8	1.6	25.4		60	26.8	20.9	1.9	4.1	
			80/67	44.1	31.9	49.6	1.6	27.3		70	26.1	19.5	2.1	3.6	
			85/71	47.1	33.2	52.6	1.6	29.7		80	25.7	18.2	2.4	3.2	
60	4.5	1.5	75/63	38.4	29.9	45.1	2.0	19.4	40	1.6	60	29.1	23.1	1.9	4.4
			80/67	41.0	30.8	47.8	2.0	20.7			70	28.5	21.7	2.2	3.9
			85/71	43.8	31.8	50.6	2.0	22.0			80	28.1	20.5	2.4	3.4
	6	2.5	75/63	38.9	30.3	45.4	1.9	20.4		60	29.9	23.8	2.0	4.5	
			80/67	41.7	31.0	48.1	1.9	21.9		70	29.3	22.5	2.2	3.9	
			85/71	44.4	32.1	51.0	1.9	23.4		80	28.8	21.1	2.4	3.5	
	9	5.1	75/63	39.4	30.2	45.7	1.8	21.3		60	30.8	24.7	2.0	4.6	
			80/67	42.2	31.4	48.5	1.8	23.1		70	30.1	23.3	2.2	4.0	
			85/71	45.1	32.2	51.4	1.8	24.7		80	29.5	21.9	2.4	3.5	
70	4.5	1.5	75/63	36.7	29.3	44.1	2.2	16.7	50	1.5	60	33.1	26.8	2.0	4.8
			80/67	39.3	30.1	46.7	2.2	17.8			70	32.6	25.5	2.2	4.3
			85/71	41.9	30.9	49.4	2.2	18.7			80	32.0	24.1	2.5	3.8
	6	2.4	75/63	37.2	29.2	44.4	2.1	17.4		60	34.2	27.8	2.0	4.9	
			80/67	39.8	30.4	47.0	2.1	18.6		70	33.6	26.4	2.3	4.4	
			85/71	42.5	31.2	49.8	2.2	19.7		80	33.0	25.0	2.5	3.9	
	9	5.0	75/63	37.6	29.8	44.6	2.1	18.3		60	35.3	28.9	2.0	5.1	
			80/67	40.3	30.6	47.3	2.1	19.4		70	34.5	27.4	2.3	4.5	
			85/71	43.1	31.3	50.1	2.1	20.7		80	33.9	25.9	2.5	4.0	
80	4.5	1.5	75/63	35.1	28.4	43.3	2.4	14.4	60	1.5	60	37.4	30.9	2.1	5.3
			80/67	37.5	29.4	45.8	2.5	15.2			70	36.7	29.5	2.3	4.7
			85/71	40.0	30.3	48.4	2.5	16.1			80	36.2	28.0	2.6	4.1
	6	2.4	75/63	35.5	28.8	43.5	2.4	15.0		60	38.7	32.2	2.1	5.4	
			80/67	37.9	29.8	46.0	2.4	15.9		70	38.0	30.6	2.3	4.8	
			85/71	40.6	30.5	48.7	2.4	16.9		80	37.3	29.1	2.6	4.2	
	9	4.9	75/63	35.8	28.7	43.7	2.3	15.4		60	40.2	33.5	2.1	5.5	
			80/67	38.4	29.7	46.3	2.3	16.5		70	39.3	31.9	2.4	4.9	
			85/71	41.1	30.4	49.0	2.3	17.5		80	38.5	30.2	2.6	4.3	
90	4.5	1.4	75/63	33.3	27.8	42.5	2.7	12.2	70	1.5	60	42.1	35.2	2.2	5.7
			80/67	35.6	29.0	44.9	2.7	13.0			70	41.2	33.7	2.4	5.0
			85/71	38.1	29.9	47.4	2.8	13.8			80	40.5	32.1	2.7	4.5
	6	2.3	75/63	33.7	28.0	42.6	2.7	12.7		60	43.7	36.7	2.2	5.8	
			80/67	36.1	28.8	45.1	2.7	13.5		70	42.7	35.1	2.4	5.2	
			85/71	38.6	29.8	47.7	2.7	14.4		80	41.9	33.4	2.7	4.6	
	9	4.7	75/63	34.1	28.5	42.8	2.6	13.2		60	45.3	38.3	2.2	6.0	
			80/67	36.5	28.8	45.3	2.6	13.9		70	44.3	36.6	2.5	5.3	
			85/71	39.0	28.9	47.9	2.7	14.5		80	43.4	34.8	2.7	4.7	
100	4.5	1.4	75/63	31.5	26.9	41.7	3.1	10.2	80	1.5	60	46.8	39.7	2.3	6.1
			80/67	33.8	28.0	44.1	3.1	11.0			70	46.1	38.1	2.5	5.4
			85/71	36.2	29.0	46.6	3.1	11.7			80	45.1	36.4	2.8	4.8
	6	2.2	75/63	31.8	27.4	41.9	3.0	10.6		60	48.8	41.5	2.3	6.2	
			80/67	34.2	28.6	44.2	3.0	11.4		70	47.7	39.7	2.5	5.5	
			85/71	36.6	29.5	46.7	3.0	12.2		80	46.7	37.9	2.8	4.9	
	9	4.6	75/63	31.9	27.8	41.7	2.8	11.2		60	50.7	43.4	2.3	6.3	
			80/67	34.2	28.7	44.4	3.1	10.9		70	49.6	41.4	2.6	5.6	
			85/71	36.9	28.6	46.9	3.0	12.3		80	48.5	39.5	2.9	5.0	
110	4.5	1.3	75/63	29.6	26.1	41.2	3.5	8.5	Extended Range - Anti-freeze required	1.5	60	46.8	39.7	2.3	6.1
			80/67	31.8	27.2	43.4	3.5	9.1			70	46.1	38.1	2.5	5.4
			85/71	34.1	28.2	45.8	3.5	9.8			80	45.1	36.4	2.8	4.8
	6	2.2	75/63	29.9	27.0	41.2	3.4	8.9		60	48.8	41.5	2.3	6.2	
			80/67	32.1	27.4	43.5	3.4	9.4		70	47.7	39.7	2.5	5.5	
			85/71	34.5	28.8	45.9	3.4	10.1		80	46.7	37.9	2.8	4.9	
	9	4.5	75/63	29.9	27.0	41.0	3.2	9.4		60	50.7	43.4	2.3	6.3	
			80/67	32.2	28.0	43.6	3.5	9.1		70	49.6	41.4	2.6	5.6	
			85/71	34.8	29.6	46.0	3.3	10.6		80	48.5	39.5	2.9	5.0	

Extended Range - Anti-freeze required

AHRI/ISO13256-1 certified performance is rated at entering air conditions of 80.6°F DB and 66.2°F WB in cooling and 68°F DB in heating.

Tabulated unit performance does not include fan or pump power corrections required for AHRI/ISO standard performance ratings.

Unit performance may be interpolated. Extrapolation is not allowed.

For conditions other than rating conditions provided, consult the BST selection software.

Ratings below 40°F are with a methanol solution.

DISCLAIMER: The performance reported herein is based on testing by FHP. Variations in the installation and operational environment may alter performance. Bosch disclaims all warranties, express and implied, that the performance will be as reported, including the warranty of merchantability and fitness for purpose. In addition, continuous research and development may result in a change to an appliances design and specifications at the time of order, which Bosch may change without notice. Before purchase, confirm the design specifications of the appliance.

Greensource i Series Model WQ

Water Source Heat Pump 1.5 to 5 Ton



Capacity Data WQ042 (1400 CFM)															
Cooling									Heating						
Entering Water Temp (°F)	Water flow (GPM)	Pressure Drop PSI	Entering Air Temp DB/WB (°F)	Total Capacity (MBTUH)	Sensible Capacity (MBTUH)	Heat of Rejection (MBTUH)	Power (kW)	EER	Entering Fluid Temp (°F)	Pressure Drop PSI	Entering Air Temp (°F)	Total Capacity (MBTUH)	Heat of Absorption (MBTUH)	Power Input (kW)	COP
50	6	3.0	75/63	43.5	34.0	50.7	2.1	20.5	30	3.3	60	29.0	21.7	2.4	3.6
			80/67	46.6	34.8	53.8	2.1	22.0			70	28.6	20.5	2.6	3.2
			85/71	49.8	35.8	56.9	2.1	23.6			80	28.4	19.3	2.9	2.9
	8	4.9	75/63	44.1	33.6	51.1	2.1	21.1		60	29.6	22.2	2.4	3.6	
			80/67	47.2	34.8	54.2	2.1	22.8		70	29.2	21.0	2.6	3.3	
			85/71	50.3	36.3	57.3	2.0	24.6		80	28.8	19.8	2.9	2.9	
	10	7.2	75/63	44.3	33.6	51.2	2.1	21.4		60	30.0	22.6	2.4	3.7	
			80/67	47.4	35.8	54.3	2.0	23.6		70	29.5	21.3	2.6	3.3	
			85/71	50.6	36.7	57.6	2.0	25.3		80	29.2	20.1	2.9	3.0	
60	6	2.8	75/63	41.7	33.2	49.6	2.3	17.9	40	3.1	60	33.1	25.5	2.4	4.0
			80/67	44.7	34.1	52.5	2.3	19.2			70	32.6	24.2	2.7	3.6
			85/71	47.6	35.3	55.5	2.3	20.6			80	32.2	23.0	2.9	3.2
	8	4.6	75/63	42.2	33.0	49.9	2.3	18.4		60	33.8	26.2	2.5	4.0	
			80/67	45.2	34.2	52.8	2.3	19.8		70	33.3	24.9	2.7	3.6	
			85/71	48.2	35.4	55.9	2.3	21.4		80	32.8	23.6	2.9	3.3	
	10	6.9	75/63	42.4	32.9	50.0	2.3	18.6		60	34.3	26.6	2.5	4.1	
			80/67	45.4	34.8	53.0	2.2	20.4		70	33.7	25.3	2.7	3.7	
			85/71	48.5	35.5	56.1	2.2	21.8		80	33.2	24.0	2.9	3.3	
70	6	2.7	75/63	39.9	32.0	48.5	2.6	15.4	50	3.0	60	37.5	29.7	2.5	4.4
			80/67	42.6	33.4	51.2	2.6	16.6			70	37.0	28.3	2.7	4.0
			85/71	45.5	34.3	54.2	2.6	17.8			80	36.5	26.9	3.0	3.6
	8	4.4	75/63	40.2	32.4	48.7	2.5	15.9		60	38.5	30.6	2.5	4.5	
			80/67	43.1	33.5	51.6	2.5	17.2		70	37.8	29.2	2.8	4.0	
			85/71	46.0	34.9	54.5	2.5	18.5		80	37.3	27.7	3.0	3.6	
	10	6.6	75/63	40.5	32.8	48.8	2.5	16.3		60	39.1	31.2	2.5	4.5	
			80/67	43.4	33.7	51.7	2.5	17.5		70	38.3	29.7	2.8	4.1	
			85/71	46.4	34.5	54.7	2.5	18.8		80	37.8	28.2	3.0	3.7	
80	6	2.6	75/63	38.1	31.5	47.5	2.8	13.4	60	2.8	60	42.3	34.3	2.6	4.8
			80/67	40.7	32.6	50.1	2.8	14.4			70	41.5	32.7	2.8	4.4
			85/71	43.4	33.6	52.8	2.8	15.3			80	40.9	31.2	3.1	3.9
	8	4.2	75/63	38.4	31.8	47.7	2.8	13.9		60	43.4	35.4	2.6	5.0	
			80/67	41.1	32.6	50.4	2.8	14.8		70	42.6	33.8	2.8	4.4	
			85/71	43.9	33.7	53.1	2.8	15.8		80	41.9	32.1	3.1	4.0	
	10	6.3	75/63	38.6	31.6	47.7	2.8	14.0		60	44.2	36.1	2.6	5.0	
			80/67	41.3	32.8	50.5	2.7	15.0		70	43.3	34.4	2.8	4.5	
			85/71	44.1	34.3	53.3	2.7	16.2		80	42.4	32.7	3.1	4.0	
90	6	2.5	75/63	36.2	30.8	46.5	3.1	11.6	70	2.7	60	47.3	39.3	2.6	5.3
			80/67	38.7	31.8	49.1	3.1	12.4			70	46.3	37.3	2.9	4.8
			85/71	41.3	32.9	51.7	3.1	13.3			80	45.4	35.6	3.1	4.3
	8	4.1	75/63	36.5	31.0	46.7	3.1	11.9		60	48.7	40.4	2.6	5.4	
			80/67	39.1	31.7	49.3	3.1	12.7		70	47.6	38.6	2.9	4.9	
			85/71	41.7	32.7	51.9	3.1	13.6		80	46.6	36.7	3.1	4.4	
	10	5.9	75/63	36.7	31.5	46.8	3.0	12.2		60	49.5	41.2	2.6	5.5	
			80/67	39.3	31.8	49.4	3.0	12.9		70	48.4	39.3	2.9	4.9	
			85/71	41.8	31.8	52.0	3.1	13.5		80	47.3	37.4	3.1	4.4	
100	6	2.4	75/63	34.3	29.9	45.7	3.4	10.0	80	2.6	60	52.5	44.1	2.7	5.8
			80/67	36.6	31.4	48.1	3.4	10.7			70	51.3	42.1	2.9	5.2
			85/71	39.1	32.1	50.6	3.4	11.4			80	50.2	40.2	3.2	4.6
	8	3.9	75/63	34.6	30.2	45.8	3.4	10.2		60	54.1	45.6	2.7	5.9	
			80/67	37.0	30.8	48.2	3.4	10.8		70	52.7	43.6	2.9	5.3	
			85/71	39.4	33.3	50.7	3.3	11.8		80	51.5	41.5	3.2	4.7	
	10	5.8	75/63	34.3	27.3	45.8	3.6	9.6		60	55.0	46.6	2.7	6.0	
			80/67	37.2	32.3	48.3	3.3	11.3		70	53.6	44.4	2.9	5.4	
			85/71	39.6	34.2	50.8	3.3	12.1		80	52.4	42.3	3.2	4.8	
110	6	2.3	75/63	32.2	28.2	44.9	3.9	8.2	Extended Range - Anti-freeze required	3.8	60	52.4	42.3	3.2	4.8
			80/67	34.4	29.9	47.1	3.9	8.9			70	51.3	40.2	3.2	4.6
			85/71	36.7	31.5	49.4	3.8	9.6			80	50.2	38.1	3.2	4.6
	8	3.8	75/63	32.3	30.4	44.7	3.7	8.8		60	54.1	45.6	2.7	5.9	
			80/67	34.6	31.9	47.1	3.7	9.4		70	52.7	43.6	2.9	5.3	
			85/71	37.1	31.6	49.6	3.8	9.8		80	51.5	41.5	3.2	4.7	
	10	5.6	75/63	32.4	30.5	44.7	3.6	9.0		60	55.0	46.6	2.7	6.0	
			80/67	34.6	31.9	47.0	3.6	9.6		70	53.6	44.4	2.9	5.4	
			85/71	37.2	33.4	49.6	3.6	10.2		80	52.4	42.3	3.2	4.8	

Extended Range - Anti-freeze required

AHRI/ISO13256-1 certified performance is rated at entering air conditions of 80.6°F DB and 66.2°F WB in cooling and 68°F DB in heating.

Tabulated unit performance does not include fan or pump power corrections required for AHRI/ISO standard performance ratings.

Unit performance may be interpolated. Extrapolation is not allowed.

For conditions other than rating conditions provided, consult the BST selection software.

Ratings below 40°F are with a methanol solution.

DISCLAIMER: The performance reported herein is based on testing by FHP. Variations in the installation and operational environment may alter performance. Bosch disclaims all warranties, express and implied, that the performance will be as reported, including the warranty of merchantability and fitness for purpose. In addition, continuous research and development may result in a change to an appliances design and specifications at the time of order, which Bosch may change without notice. Before purchase, confirm the design specifications of the appliance.

Greensource i Series Model WQ

Water Source Heat Pump 1.5 to 5 Ton



Capacity Data WQ048 (1600 CFM)															
Cooling									Heating						
Entering Water Temp (°F)	Water flow (GPM)	Pressure Drop PSI	Entering Air Temp DB/WB (°F)	Total Capacity (MBTUH)	Sensible Capacity (MBTUH)	Heat of Rejection (MBTUH)	Power (kW)	EER	Entering Fluid Temp (°F)	Pressure Drop PSI	Entering Air Temp (°F)	Total Capacity (MBTUH)	Heat of Absorption (MBTUH)	Power Input (kW)	COP
50	6	1.0	75/63	52.0	40.1	60.5	2.5	21.2	30	1.1	60	36.1	26.2	3.2	3.35
			80/67	55.4	41.2	63.9	2.5	22.4			70	35.5	24.7	3.5	2.99
			85/71	58.8	42.3	67.4	2.5	23.6			80	35.0	23.1	3.8	2.68
	8	1.7	75/63	53.0	40.4	61.1	2.3	22.6		60	37.3	27.2	3.2	3.43	
			80/67	56.4	41.6	64.6	2.4	23.9		70	36.6	25.6	3.5	3.06	
			85/71	60.0	42.7	68.2	2.4	25.3		80	36.0	23.9	3.8	2.74	
	12	3.5	75/63	53.9	40.8	61.7	2.2	24.0		60	38.7	28.4	3.2	3.53	
			80/67	57.5	42.0	65.3	2.2	25.6		70	37.9	26.8	3.5	3.14	
			85/71	61.2	43.1	69.0	2.3	27.2		80	36.9	24.6	3.9	2.79	
			75/63	50.1	39.2	59.3	2.7	18.6		60	40.9	30.4	3.3	3.68	
60	6	1.0	80/67	53.3	40.4	62.6	2.7	19.6	40	1.1	70	40.4	28.8	3.6	3.3
			85/71	56.6	41.5	66.1	2.7	20.7			80	39.7	27.5	3.9	2.95
			75/63	51.0	39.6	59.9	2.6	19.7			60	42.2	31.9	3.3	3.76
	8	1.7	80/67	54.3	40.8	63.2	2.6	20.9		70	41.8	29.9	3.6	3.39	
			85/71	57.8	41.9	66.8	2.6	22.2		80	41.3	28.6	4.0	3.04	
			75/63	51.9	40.0	60.4	2.5	21.0		60	43.9	33.3	3.3	3.87	
	12	3.5	80/67	55.3	41.2	63.9	2.5	22.3		70	43.0	31.6	3.6	3.45	
			85/71	59.0	42.0	67.5	2.5	23.8		80	42.8	29.7	4.0	3.12	
			75/63	48.0	38.4	58.2	3.0	16.1		60	46.0	35.2	3.4	4.01	
			80/67	51.1	39.6	61.4	3.0	17.1		70	45.5	33.6	3.7	3.6	
70	6	1.0	85/71	54.3	40.7	64.7	3.0	18.0	50	2.1	80	45.3	31.4	4.1	3.25
			75/63	48.9	38.7	58.6	2.9	17.1			60	47.7	37.0	3.4	4.12
			80/67	52.1	39.9	61.9	2.9	18.2			70	47.3	35.0	3.7	3.71
	8	1.7	85/71	55.5	41.1	65.4	2.9	19.3		80	46.5	33.5	4.1	3.31	
			75/63	49.7	39.1	59.1	2.7	18.1		60	49.7	38.6	3.4	4.24	
			80/67	53.1	40.3	62.5	2.7	19.4		70	48.9	37.1	3.8	3.79	
	12	3.4	85/71	56.6	41.2	66.0	2.7	20.6		80	48.2	34.3	4.1	3.41	
			75/63	45.9	37.5	57.1	3.3	13.9		60	51.5	40.8	3.5	4.34	
			80/67	48.9	38.7	60.2	3.3	14.8		70	51.0	38.9	3.8	3.91	
			85/71	52.1	39.6	63.4	3.3	15.6		80	50.5	37.0	4.2	3.51	
80	6	1.0	75/63	46.7	37.9	57.5	3.2	14.8	60	2.1	60	53.6	42.8	3.5	4.47
			80/67	49.8	39.1	60.6	3.2	15.7			70	52.9	40.9	3.9	4
			85/71	53.1	40.0	64.0	3.2	16.7			80	52.4	38.5	4.3	3.6
	8	1.6	75/63	47.5	38.4	57.9	3.0	15.6		60	56.2	44.8	3.6	4.62	
			80/67	50.8	39.0	61.2	3.1	16.6		70	55.0	43.0	3.9	4.11	
			85/71	54.1	40.6	64.6	3.0	17.8		80	54.3	40.8	4.3	3.69	
	12	3.3	75/63	43.7	36.6	56.0	3.7	12.0		60	57.4	46.4	3.6	4.68	
			80/67	46.6	37.6	59.1	3.7	12.7		70	56.8	44.3	4.0	4.21	
			85/71	49.6	38.9	62.2	3.7	13.4		80	56.2	42.1	4.4	3.78	
			75/63	44.5	36.9	56.4	3.5	12.6		60	59.9	48.8	3.6	4.81	
90	6	0.9	80/67	47.5	37.9	59.5	3.5	13.5	70	3.3	70	59.2	46.3	4.0	4.33
			85/71	50.7	39.1	62.7	3.5	14.3			80	58.4	44.2	4.4	3.87
			75/63	45.0	36.3	56.7	3.5	12.9			60	62.8	51.5	3.7	4.96
	8	1.5	80/67	48.3	37.9	59.9	3.4	14.1		70	61.8	48.8	4.1	4.45	
			85/71	51.6	39.3	63.2	3.4	15.1		80	60.7	46.7	4.5	3.97	
			75/63	41.4	35.7	55.1	4.1	10.2		60	63.9	51.8	3.7	5.03	
	12	3.2	80/67	44.2	36.8	58.0	4.1	10.8		70	62.8	50.1	4.1	4.49	
			85/71	47.0	38.1	61.0	4.1	11.5		80	62.0	47.9	4.5	4.03	
			75/63	42.2	35.7	55.4	3.9	10.7		60	66.5	55.1	3.8	5.14	
			80/67	45.1	37.0	58.4	3.9	11.4		70	65.7	52.2	4.2	4.62	
100	6	0.9	85/71	48.1	38.2	61.4	4.0	12.2	80	3.3	80	64.7	49.8	4.6	4.14
			75/63	42.7	36.5	55.6	3.8	11.3			60	69.7	58.0	3.9	5.3
			80/67	45.6	36.6	58.6	3.9	11.7			70	68.4	55.6	4.2	4.73
	8	1.5	85/71	48.9	38.6	61.8	3.8	12.8		80	67.4	52.7	4.6	4.25	
			75/63	39.0	34.8	54.3	4.5	8.6		60	71.9	61.3	3.4	6.02	
			80/67	41.7	35.9	57.1	4.6	9.1		70	71.3	59.7	3.7	5.55	
	12	3.1	85/71	44.3	37.3	59.9	4.6	9.7		80	70.7	58.1	4.0	5.07	
			75/63	39.7	34.9	54.5	4.4	9.0		60	75.5	66.5	3.2	6.76	
			80/67	42.5	36.0	57.3	4.4	9.6		70	74.9	64.9	3.5	6.28	
			85/71	45.3	37.2	60.3	4.4	10.2		80	74.3	63.3	3.8	5.80	
110	6	0.9	75/63	40.2	34.7	54.7	4.3	9.3	90	3.3	60	79.7	73.1	2.9	8.09
			80/67	43.1	36.8	57.6	4.3	10.1			70	79.1	71.5	3.2	7.61
			85/71	46.1	37.6	60.6	4.3	10.8			80	78.5	69.9	3.5	7.13
	8	1.5	75/63	39.7	34.9	54.5	4.4	9.0		60	84.5	80.9	2.5	9.21	
			80/67	42.5	36.0	57.3	4.4	9.6		70	83.9	79.3	2.8	8.73	
			85/71	45.3	37.2	60.3	4.4	10.2		80	83.3	77.7	3.1	8.25	
	12	3.1	75/63	40.2	34.7	54.7	4.3	9.3		60	89.7	86.1	2.3	10.31	
			80/67	43.1	36.8	57.6	4.3	10.1		70	89.1	84.5	2.6	9.83	
			85/71	46.1	37.6	60.6	4.3	10.8		80	88.5	82.9	2.9	9.35	
			75/63	39.0	34.8	54.3	4.5	8.6		60	94.7	91.1	2.1	11.37	

Extended Range - Anti-freeze required

AHR/ISO1325G-1 certified performance is rated at entering air conditions of 80.6°F DB and 66.2°F WB in cooling and 68°F DB in heating.

Tabulated unit performance does not include fan or pump power corrections required for AHR/ISO standard performance ratings.

Unit performance may be interpolated. Extrapolation is not allowed.

For conditions other than rating conditions provided, consult the BST selection software.

Ratings below 40°F are with a methanol solution.

DISCLAIMER: The performance reported herein is based on testing by FHP. Variations in the installation and operational environment may alter performance. Bosch disclaims all warranties, express and implied, that the performance will be as reported, including the warranty of merchantability and fitness for purpose. In addition, continuous research and development may result in a change to an appliances design and specifications at the time of order, which Bosch may change without notice. Before purchase, confirm the design specifications of the appliance.

Greensource i Series Model WQ

Water Source Heat Pump 1.5 to 5 Ton



Capacity Data WQ060 (1900 CFM)																
Cooling									Heating							
Entering Water Temp (°F)	Water flow (GPM)	Pressure Drop PSI	Entering Air Temp DB/WB (°F)	Total Capacity (MBTUH)	Sensible Capacity (MBTUH)	Heat of Rejection (MBTUH)	Power (kW)	EER	Entering Fluid Temp (°F)	Pressure Drop PSI	Entering Air Temp (°F)	Total Capacity (MBTUH)	Heat of Absorption (MBTUH)	Power Input (kW)	COP	
50	7.5	2.0	75/63	62.4	47.2	73.4	3.2	19.5	30	2.1	60	47.6	35.2	3.9	3.6	
			80/67	66.5	48.4	77.7	3.2	20.5			70	46.9	33.4	4.3	3.2	
			85/71	70.7	49.7	82.1	3.3	21.5			80	46.4	31.4	4.7	2.9	
	12	4.6	75/63	64.2	47.9	74.5	3.0	21.6		60	50.2	37.8	4.0	3.7		
			80/67	68.4	49.3	78.9	3.0	22.8		70	49.3	35.7	4.4	3.3		
			85/71	72.9	50.5	83.5	3.0	24.0		80	48.8	33.4	4.8	3.0		
	15	6.8	75/63	64.7	48.2	74.8	2.9	22.3		60	51.2	38.7	4.0	3.8		
			80/67	69.1	49.5	79.3	2.9	23.7		70	50.3	36.6	4.4	3.4		
			85/71	73.7	50.4	84.0	3.0	25.0		80	49.7	34.2	4.8	3.0		
60	7.5	2.0	75/63	60.0	46.1	72.1	3.5	17.1	40	2.0	60	53.8	40.8	4.0	3.9	
			80/67	63.9	47.4	76.2	3.6	18.0			70	53.0	39.0	4.5	3.5	
			85/71	68.0	48.7	80.5	3.6	18.9			80	52.4	37.0	4.9	3.1	
	12	4.5	75/63	61.7	46.8	73.0	3.3	18.7		60	57.0	44.1	4.1	4.1		
			80/67	65.8	48.2	77.3	3.3	19.8		70	56.2	41.9	4.5	3.6		
			85/71	70.3	49.2	81.8	3.4	20.9		80	55.4	39.7	5.0	3.3		
	15	6.7	75/63	62.2	47.0	73.3	3.2	19.3		60	58.4	45.4	4.2	4.1		
			80/67	66.5	48.1	77.7	3.3	20.5		70	57.4	43.1	4.6	3.7		
			85/71	70.9	49.4	82.2	3.3	21.7		80	56.5	40.7	5.0	3.3		
70	7.5	1.9	75/63	57.5	45.0	70.7	3.9	14.9	50	2.0	60	60.6	47.4	4.2	4.2	
			80/67	61.3	46.4	74.7	3.9	15.7			70	60.0	45.0	4.6	3.8	
			85/71	65.2	47.7	78.9	4.0	16.5			80	59.2	43.1	5.1	3.4	
	12	4.4	75/63	59.1	45.7	71.6	3.6	16.3		60	64.7	51.3	4.3	4.4		
			80/67	63.1	47.1	75.7	3.7	17.2		70	63.7	48.9	4.7	3.9		
			85/71	67.4	48.1	80.1	3.7	18.2		80	62.8	46.5	5.2	3.5		
	15	6.5	75/63	59.7	45.6	71.9	3.6	16.7		60	66.4	52.8	4.4	4.5		
			80/67	63.8	46.9	76.1	3.6	17.7		70	65.3	50.3	4.8	4.0		
			85/71	68.1	48.3	80.5	3.6	18.8		80	64.2	47.7	5.3	3.6		
80	7.5	2.0	75/63	54.8	44.0	69.3	4.2	12.9	60	2.0	60	68.1	54.3	4.4	4.5	
			80/67	58.5	45.4	73.2	4.3	13.6			70	67.2	52.2	4.8	4.1	
			85/71	62.4	46.4	77.3	4.3	14.4			80	66.4	49.7	5.3	3.7	
	12	3.3	75/63	56.4	44.6	70.1	4.0	14.0		60	73.1	59.0	4.5	4.7		
			80/67	60.3	45.7	74.2	4.0	14.9		70	71.9	56.4	5.0	4.2		
			85/71	64.4	47.1	78.4	4.1	15.8		80	70.8	53.7	5.5	3.8		
	15	4.9	75/63	56.8	45.0	70.3	3.9	14.4		60	75.0	60.8	4.6	4.8		
			80/67	60.9	45.8	74.5	4.0	15.3		70	73.7	58.0	5.0	4.3		
			85/71	65.0	47.0	78.7	4.0	16.2		80	72.5	55.2	5.5	3.9		
90	7.5	1.4	75/63	52.1	42.9	68.1	4.7	11.1	70	1.9	60	76.1	61.7	4.6	4.8	
			80/67	55.7	44.1	71.9	4.7	11.8			70	75.1	59.3	5.1	4.3	
			85/71	59.4	45.5	75.7	4.8	12.4			80	74.4	56.3	5.6	3.9	
	12	3.2	75/63	53.6	43.1	68.8	4.5	12.0		60	81.9	67.2	4.8	5.0		
			80/67	57.4	44.5	72.6	4.5	12.8		70	80.6	64.3	5.2	4.5		
			85/71	61.2	46.1	76.6	4.5	13.6		80	79.1	61.4	5.7	4.0		
	15	4.7	75/63	54.0	42.9	69.0	4.4	12.2		60	84.2	69.2	4.8	5.1		
			80/67	57.8	44.5	72.9	4.4	13.1		70	82.7	66.2	5.3	4.6		
			85/71	61.8	46.3	77.0	4.4	14.0		80	81.0	63.2	5.8	4.1		
100	7.5	1.4	75/63	49.4	41.6	67.0	5.2	9.5	80	2.0	60	84.5	69.3	4.8	5.1	
			80/67	52.8	43.1	70.6	5.2	10.1			70	83.3	66.7	5.3	4.6	
			85/71	56.4	44.2	74.3	5.3	10.7			80	81.9	64.1	5.8	4.1	
	12	3.1	75/63	50.7	41.9	67.5	5.0	10.2		60	91.2	75.6	5.1	5.3		
			80/67	54.3	43.5	71.2	5.0	10.9		70	89.5	72.5	5.5	4.8		
			85/71	57.9	45.1	75.0	5.0	11.6		80	88.0	69.4	6.0	4.3		
	15	4.6	75/63	51.0	42.4	67.6	4.9	10.5		60	93.8	78.0	5.1	5.4		
			80/67	54.8	43.7	71.4	4.9	11.2		70	91.9	74.7	5.6	4.8		
			85/71	58.4	45.3	75.3	4.9	11.9		80	89.5	71.5	6.1	4.3		
110	7.5	1.3	75/63	46.4	40.4	66.0	5.8	8.0	Extended Range - Anti-freeze required	2.1	60	89.5	71.5	6.1	4.3	
			80/67	49.8	41.7	69.5	5.8	8.5			70	88.0	69.4	6.0	4.3	
			85/71	53.0	43.4	73.0	5.9	9.0			80	86.5	67.3	6.5	3.9	
	12	3.1	75/63	47.6	40.7	66.4	5.6	8.6		60	92.2	76.6	5.1	5.3		
			80/67	51.1	42.1	69.9	5.6	9.2		70	90.7	74.5	5.6	4.8		
			85/71	54.5	43.9	73.5	5.6	9.8		80	89.2	72.4	6.1	4.3		
	15	4.5	75/63	47.9	41.3	66.5	5.5	8.8		60	94.2	80.6	5.1	5.4		
			80/67	51.4	42.7	70.0	5.5	9.4		70	92.7	78.5	5.6	4.9		
			85/71	55.1	43.5	73.8	5.5	10.0		80	91.2	76.4	6.1	4.4		

Extended Range - Anti-freeze required

AHRI/ISO13256-1 certified performance is rated at entering air conditions of 80.6°F DB and 66.2°F WB in cooling and 68°F DB in heating.

Tabulated unit performance does not include fan or pump power corrections required for AHRI/ISO standard performance ratings.

Unit performance may be interpolated. Extrapolation is not allowed.

For conditions other than rating conditions provided, consult the BST selection software.

Ratings below 40°F are with a methanol solution.

DISCLAIMER: The performance reported herein is based on testing by FHP. Variations in the installation and operational environment may alter performance. Bosch disclaims all warranties, express and implied, that the performance will be as reported, including the warranty of merchantability and fitness for purpose. In addition, continuous research and development may result in a change to an appliances design and specifications at the time of order, which Bosch may change without notice. Before purchase, confirm the design specifications of the appliance.

Greensource i Series Model WQ
Water Source Heat Pump 1.5 to 5 Ton



BOSCH

Antifreeze Correction							
Antifreeze Type	Antifreeze %	Cooling			Heating		WPD Correction Factor EWT 30 °F
		EWT 90 Deg.F			EWT 30 Deg. F		
		Total Cap.	Sens. Cap	Power	Htg. Cap	Power	
Water	0	1.000	1.000	1.000	1.000	1.000	1.000
Propylene Glycol	5	0.997	0.997	1.004	0.989	0.997	1.060
	10	0.994	0.994	1.006	0.986	0.995	1.125
	15	0.990	0.990	1.009	0.978	0.988	1.190
	25	0.983	0.983	1.016	0.960	0.979	1.300
Methanol	5	0.997	0.997	1.003	0.990	0.997	1.060
	10	0.996	0.996	1.005	0.979	0.993	1.100
	15	0.994	0.994	1.008	0.970	0.990	1.140
Ethanol	5	0.998	0.998	1.002	0.981	0.994	1.160
	10	0.996	0.996	1.004	0.960	0.988	1.230
	15	0.992	0.992	1.006	0.944	0.983	1.280
	25	0.986	0.986	1.009	0.917	0.974	1.400
Ethylene Glycol	5	0.997	0.997	1.003	0.993	0.998	1.060
	10	0.995	0.995	1.004	0.986	0.996	1.120
	15	0.992	0.992	1.005	0.980	0.993	1.190
	25	0.988	0.988	1.009	0.970	0.990	1.330
	30	0.985	0.985	1.012	0.965	0.987	1.400

Greensource i Series Model WQ

Water Source Heat Pump 1.5 to 5 Ton



Field Installed Accessory - Pump/Valve Relay Kit														
Part Number	WQ018		WQ024		WQ030		WQ036		WQ042		WQ048		WQ060	
	VT	HZ	VT	HZ	VT	HZ	VT	HZ	VT	HZ	VT	HZ	VT	HZ
8733908180	•	•	•	•	•	•	•	•	•	•	•	•	•	•

Field Installed Accessory - Flow Proving Switch (Differential Pressure) Kit														
Part Number	WQ018		WQ024		WQ030		WQ036		WQ042		WQ048		WQ060	
	VT	HZ	VT	HZ	VT	HZ	VT	HZ	VT	HZ	VT	HZ	VT	HZ
8733920264	•	•	•	•	•	•	•	•	•	•	•	•	•	•

Field Installed Accessory - Swivel Connector Kit (two connectors per package)															
Order Number	Type & Size	WQ018		WQ024		WQ030		WQ036		WQ042		WQ048		WQ060	
		VT	HZ	VT	HZ	VT	HZ	VT	HZ	VT	HZ	VT	HZ	VT	HZ
7738003200	Male 3/4" NPT	•	•	•	•	•	•	•	•	•	•				
7738003201	Male 1" NPT											•	•	•	•

Field Installed Accessory - SmartStart Assist Kit														
Part Number	WQ018		WQ024		WQ030		WQ036		WQ042		WQ048		WQ060	
	VT	HZ	VT	HZ	VT	HZ	VT	HZ	VT	HZ	VT	HZ	VT	HZ
8733957159			•	•	•	•	•	•						
8733957160									•	•	•	•	•	•

Field Installed Accessory - Duct Mounted Electric Heaters 208/230V							
Nominal BTUH	Order #				Nominal CFM	Duct Flange Connection in Inches	Nominal Dimension in Inches
	5 kW	10 kW	15 kW	20 kW			
18000	7738002745	N/A	N/A	N/A	600	13.75 x 13.75	14 x 14
24000	7738002746	7738002747	N/A	N/A	800	13.75 x 13.75	14 x 14
30000	7738002748	7738002749	N/A	N/A	1000	15.75 x 15.75	16 x 16
36000	7738002748	7738002749	N/A	N/A	1200	15.75 x 15.75	16 x 16
42000	7738002747	7738002751	7738002752	N/A	1400	17.75 x 17.75	18 x 18
48000	7738002747	7738002751	7738002752	N/A	1600	17.75 x 17.75	18 x 18
60000	7738002747	7738002751	7738002752	7738002753	2000	17.75 x 17.75	18 x 18
70000	7738002747	7738002751	7738002752	7738002753	2200	17.75 x 17.75	18 x 18

i Duct mounted heaters are only available in single phase 208/230 V. Please refer to Manufacturer's Installation and Operation Manual for proper installation and guidelines. It is recommended to use a seven (7) conductor cables for thermostat interface. It is required for the duct mounted heater to have an independent power supply. In fiberglass duct systems, a metal sleeve MUST be used as an insert and support to the heater.

Greensource i Series Model WQ

Water Source Heat Pump 1.5 to 5 Ton



BOSCH

Field Installed Accessory - Stainless Steel Hose Kits						
Options	Option 1	Option 2	Option 3**	Option 4**, ***	Option 5**, ***	Option 6**, ***
Hose Size (Length, Diameter)	Hoses Only with Swivel	Hose Kit Hoses with Ported Ball Valves, Swivel and One P/T*	Hose Kit with Automatic Flow Valve (AFV)*	Hose kit with AFV, Y-Strainer & Blow Down Valve*	Hose Kit with AFV and Electric Valve*	Hose Kit with AFV, Y-Strainer, BDV and Electric Valve*
	Part #	Part #	Part #	Part #	Part #	Part #
12 Inch						
1/2" L	T111H02121	T111H02122	T111H02123	T111H02124	T111H02125	T111H02126
24 Inch						
3/4" S	T111H03241	T111H03242	T111H03243	T111H03244	T111H03245	T111H03246
1" L	T111H04241	T111H04242	T111H04243	T111H04244	T111H04245	T111H04246
1" S	T111H04241	T111H04242	T111H04247	T111H04248	T111H04249	T111H04240
1 - 1/4" S	T111H05241	T111H05242	T111H05243	T111H05244	T111H05245	T111H05246
1 - 1/2" L	T111H06241	T111H06242	T111H06243	T111H06244	T111H06245	T111H06246
1 - 1/2" S	T111H06241	T111H06242	T111H06247	T111H06248	T111H06249	T111H06240
2" S	T111H08241	T111H08242	T111H08243	T111H08244	T111H08245	T111H08246
36 Inch						
3/4" S	T111H03361	T111H03362	T111H03363	T111H03364	T111H03365	T111H03366
1" L	T111H04361	T111H04362	T111H04363	T111H04364	T111H04365	T111H04366
1" S	T111H04361	T111H04362	T111H04367	T111H04368	T111H04369	T111H04360
1 - 1/4" S	T111H05361	T111H05362	T111H05363	T111H05364	T111H05365	T111H05366
1 - 1/2" L	T111H06361	T111H06362	T111H06363	T111H06364	T111H06365	T111H06366
1 - 1/2" S	T111H06361	T111H06362	T111H06367	T111H06368	T111H06369	T111H06360
2" S	T111H08361	T111H08362	T111H08363	T111H08364	T111H08365	T111H08366

* All Hose Kits include S/R ported ball valves with swivel and P/T port.

** 'L' and 'S' only apply to kit options 3 through 6

*** GMP's are required for hose kits in options 3-6

Hose Kit Flow Rates by Size

Please see Technical Service Bulletin: Heat Pump Hose Kits – Water Flow Rates.
 This document is located at www.bosch-climate.us under Support Center > Downloads > Downloads for Bosch Products > Service Bulletins.

Greensource i Series Model WQ

Water Source Heat Pump 1.5 to 5 Ton



Field Installed Accessory - Bosch Connected Control Wi-Fi Thermostat

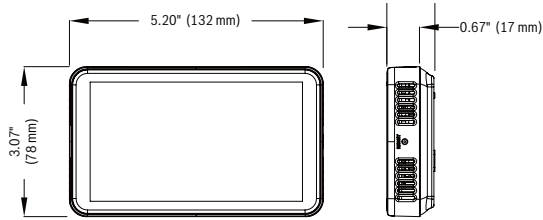
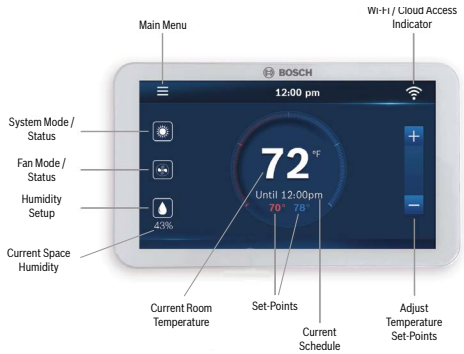

Description	Part Number	Heat	Cool	Humidity
Bosch Connected Control (BCC100)	8733948009	4	2	Yes

Specifications

- 5 Inch Touch Screen 854 x 480 Pixels
- 7 Relay Outputs (Terminals) G, Y1, Y2, W1, W2, O/B, H/dH
- 1 Data Input (Pulse signals from Bosch WSHP)
- Displays Bosch Water Source Heat Pump Fault Messages
- Wi-Fi (802.11a/b/g/n) 2.4GHz (not compatible with 5GHz)
- FCC and IC Certification
- 5 Year Limited Warranty (see website for details: <https://www.bosch-climate.us/products-bosch-thermotechnology/thermostats-and-controls/residential-thermostats-controls/bcc100.html>)

Compatibility

- Conventional (Gas, Oil, Electric): Up to 2 Heat / 2 Cool
- Heat Pump (O/B to energize reversing valve in cool/heat): Up to 4 Heat / 2 Cool
- Supports up to 1 Accessory Unit: Humidifier or Dehumidifier (not provided by Bosch)
- Unit Modes: Heat, Cool, Auto, Off, Emergency Heat
- Fan Modes: Auto, On, Circulate
- Supports 2 Transformer Systems (Rh and Rc)
- C-Wire Required for Installation
- Supports Active and Passive Dehumidification without the need for external relays, such as Bosch Water Source Heat Pump products equipped with a Hot Gas Reheat Coil and/or ECM motor

Greensource i Series Model WQ Water Source Heat Pump 1.5 to 5 Ton



Field Installed Accessory - Bosch Connected Control Wi-Fi Thermostat

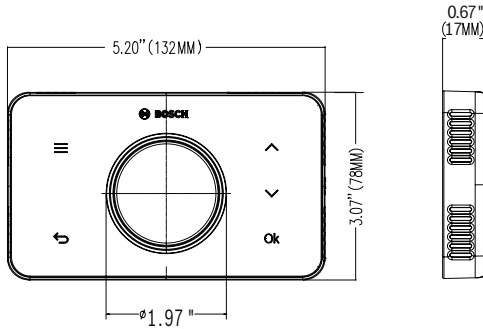
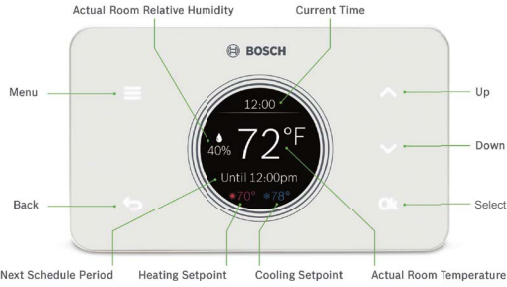

Description	Part Number	Heat	Cool	Humidity
Bosch Connected Control (BCC50)	8-733-952-994	3	2	Yes

Specifications

- 2.8 Inch Non-Touch LCD Screen 240 x 320 Pixels
- 5 Back-lit Touch Buttons
- 6 Relay Terminals: G, Y1, Y2, W/E/AUX, O/B/W2, H/DH
- Wi-Fi (802.11b/g/n) 2.4GHz (not compatible with 5GHz)
- FCC and IC Certification
- 3 Year Limited Warranty (see <https://www.bosch-thermotechnology.us/us/en/residential/service/product-warranty-library/> for details)

Compatibility

- Conventional (Gas, Oil, Electric): Up to 2 Heat / 2 Cool
- Heat Pump (O/B/W2 to energize reversing valve in cool/heat): Up to 3 Heat / 2 Cool
- Supports up to 1 Accessory Unit: Humidifier or Dehumidifier (not provided by Bosch)
- Unit Modes: Heat, Cool, Auto, Em Heat (Heat Pump & Dual Fuel only), Off
- Fan Modes: Auto, On, Circulate
- Supports 2 Transformer Systems (Rh and Rc)
- C-Wire Required for Installation
- Supports Active and Passive Dehumidification without the need for external relays, such as Bosch Water Source Heat Pump products equipped with a Hot Gas Reheat Coil and/or ECM motor