



11EER W42HC-W60HC Series WALL-MOUNT™

The Bard Wall-Mount Heat Pump is a self contained energy efficient heating and cooling system, which is designed to offer maximum indoor comfort at a minimal cost without using valuable indoor floor space or outside ground space. This unit is the ideal product for versatile applications such as: new construction, modular offices, school modernization, telecommunication structures, portable structures or correctional facilities. Factory or field installed accessories are available to meet specific job requirements.

- Complies with efficiency requirements of ASHRAE/IESNA 90.1-2016
- Certified to ASNI/ARI Standard 390-2003 for SPVU (Single Package Vertical Units)
- Intertek ETL Listed to Standard for Safety Heating and Cooling Equipment ANSI/UL 1995/CSA 22.2 No. 236-05 Fourth Edition
- Commercial Product - Not intended for residential application
- Bard is an ISO 9001:2015 Certified Manufacturer
- The AHRI Certified® mark indicates Bard Manufacturing Company participation in the AHRI Certification program. For verification of individual certified products, go to www.ahridirectory.org.



BARDHVAC.COM

FORM NO. S3584-0121



///// WALL-MOUNT NOMENCLATURE

W 6 0 H C - A 0 Z X P X X X X

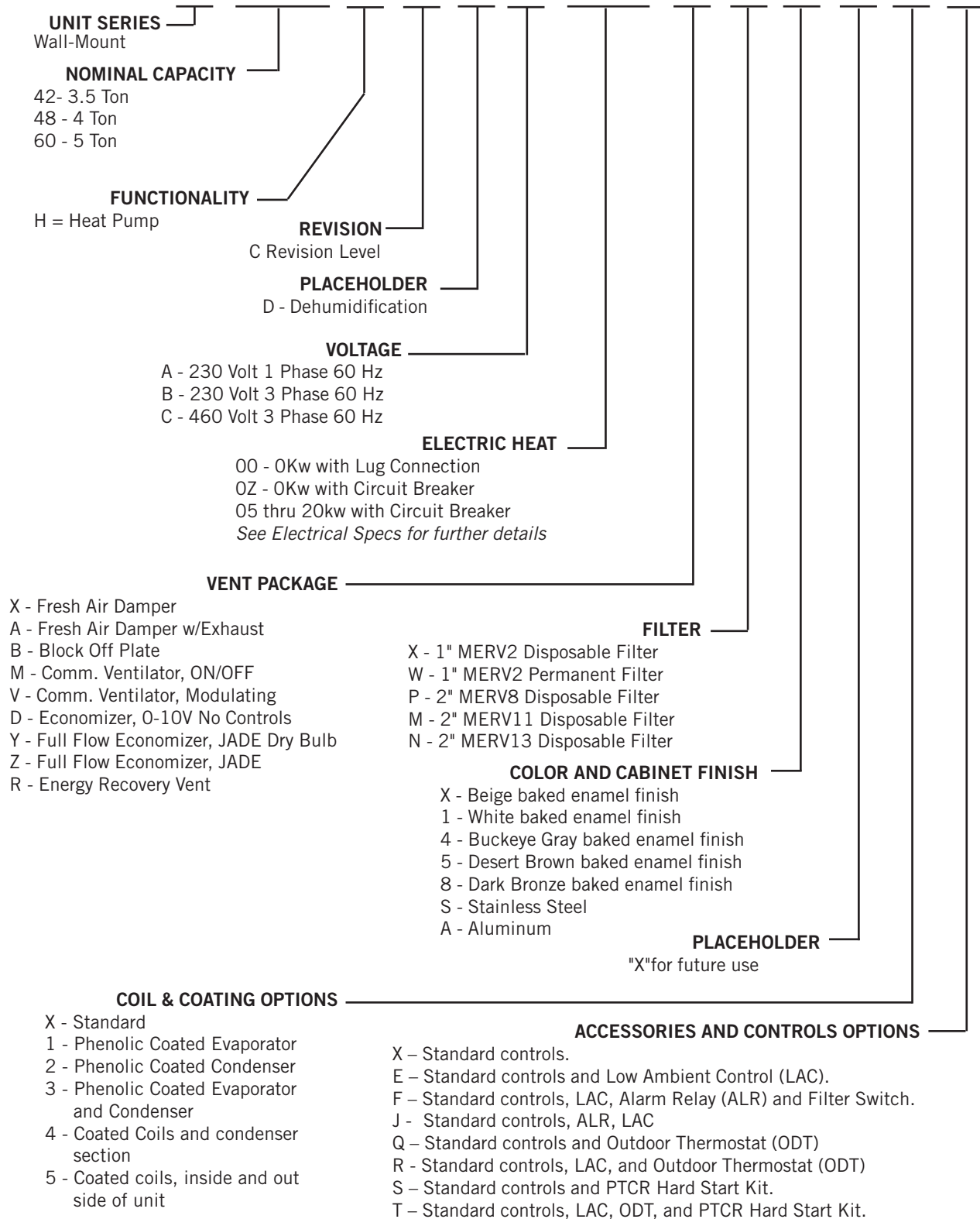

ENGINEERED FEATURES

NEW! EXCLUSIVE *Non-Fiberglass Foil Faced Insulation: Environmentally friendly high “R” value non-fiberglass insulation that is made with recycled denim and cotton materials used with a FSK foil face that is both durable and cleanable.

Durable Cabinet Construction: Multiple cabinet construction options are available for different outdoor conditions. Optional cabinet coatings may be ordered for extreme outdoor environments. Front access control panel location.

Green Fin Hydrophilic Evaporator Coil: Green fin stock is used to help prevent mold growth, aid with condensate drainage, and provide a limited amount of protection to corrosive particulates in the airstream.

Optional Mechanical Dehumidification: Models are available with hot gas reheat dehumidification for energy efficient humidity removal. Electronic Expansion Valves are standard for all dehumidification models.

Field or Factory Installed Vents: Multiple ventilation options are available as easily installed kits with electrical plugs, or Factory installed options that can be removed for service. Economizer operation includes improved airpath for minimized recirculation.

Reliable, Easy-to-Use Controls: Easily accessible through front control panel locations. A lockable hinged access cover to circuit protection is provided. Phase rotation monitor is standard on all 3 phase models. Adjustable compressor on/off delay timer (CCM) with diagnostic lights is standard on all models.

ECM Indoor Brushless DC Motor Technology: 5 speed dual shaft motor provides quiet airflow operation when used with a twin blower assembly. Motor overload protection standard on all models.

Electric Strip Heat: Reliable, comfortable heater packages feature an automatic limit and thermal cut-off safety control. Heater packages can be factory or field installed.

Easy Filter Access: A separate filter door is provided for ease of filter access during routine unit maintenance. 1” and 2” filters are available with a rating of up to MERV13.

Enclosed Condenser Motor: An enclosed casing condenser motor with ball bearings is used for reliable operation and extended motor life. Enclosed condenser motors are standard on all units.

Improved Condenser Coil Cleaning: Removable fan shroud side panels allow for easy condenser coil intake surface cleaning.

High Efficiency Cooling: Scroll compressors for quiet, efficient cooling. Designed with R-410A (HFC) non-ozone depleting refrigerant in compliance with the Montreal protocol and 2010 EPA requirements. A liquid line filter-drier to protect the system from moisture is standard on all units.

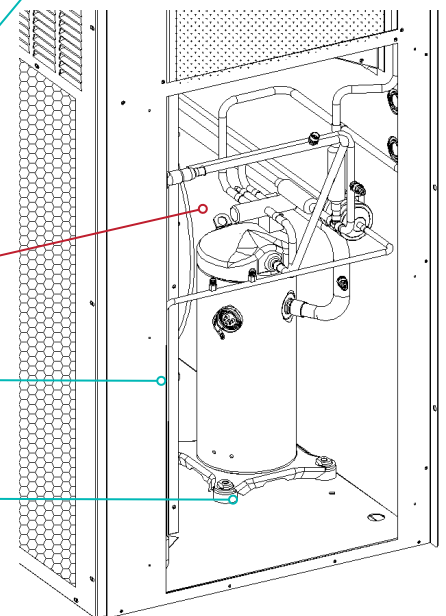
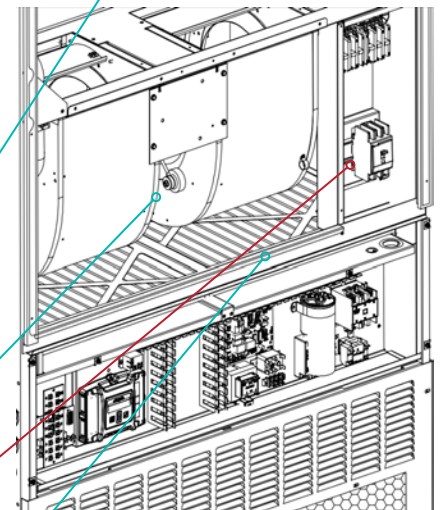
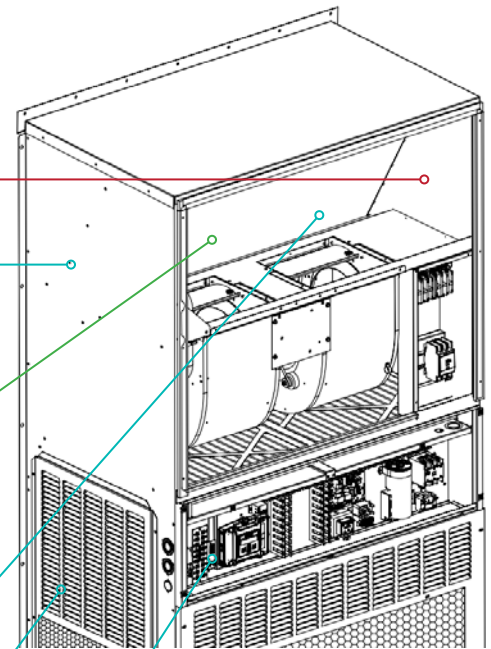

UNIT MODES OF OPERATION

Cooling Operation: The Bard WH Series WALL MOUNT products offer single stage cooling operation using R410A refrigerant. Copper tube/Aluminum fin coils are used to provide high efficiency and easy serviceability. Scroll compressor technology delivers years of quiet, reliable operation.



Heating Operation: The Bard WH Series WALL MOUNT products offer single stage heat pump operation and optional single or two stage heating operation using resistance heaters. Circuit breaker disconnect protection is standard in all units equipped with electric heat. The reversing valve is energized (B) for heat pump operation.



Mechanical Dehumidification Operation: The Bard WH Series WALL MOUNT products offer optional dehumidification that removes moisture from air entering the unit. A three-way valve, reheat coil, and electronic expansion valve (EEV) are standard with all models. The dehumidification circuit incorporates an independent heat exchanger coil in the supply air stream. This coil reheats the supply air after it passes over the cooling coil without requiring the electric resistance heater to be used for reheat purposes. This results in very high mechanical dehumidification capability from the air conditioner on demand without using electric resistance reheat.



Ventilation Operation: The Bard WH Series WALL MOUNT products offer optional ventilation that brings outdoor air into the structure. Vent options can be factory or field installed, and can be used to bring in outdoor air for occupants, save energy by using outdoor air for free cooling, or positively pressurize a structure. Exhaust air options allow room air to be vented outdoors when fresh air is being brought into the structure. Energy recovery options are also available for occupied structures which condition the air being brought in to save energy when ventilation is necessary regardless of outdoor temperature.



ADVANCED FEATURE DESCRIPTIONS

ECM Indoor Blower Motor: Energy efficient indoor blower motors use EC constant torque technology with 5 pre-programmed speeds. By selecting the needed speed, the WALL MOUNT product can reduce or increase airflow. A NEMA48® frame enclosure is used. A medium and high speed tap can be user selected to offer the maximum CFM possible with the blower assembly.

- Efficient 5 speed ECM constant torque motor. 24VAC power used for speed selection.
- Fully potted electronic control module for moisture protection.
- 6000V surge protection.
- Dual shaft design with open air over (OAO) enclosure.



Outdoor Fan Motor: Outdoor fan motors use ball bearing construction and are fully enclosed for increased life expectancy.

- Single speed PSC motor.
- Totally enclosed motor housing protects motor windings and internal components from corrosion.
- Ball bearing design reduces motor wear from “windmill” affect when not in operation.



Non Fiberglass Cabinet Insulation: The WH MOUNT products use advanced non-fiberglass insulation that is made with recycled denim materials. High "R" value, enhanced sound absorption, and reduced delamination are some of the features of this revolutionary product.

- Easy to clean and ramage resistant Foil FSK Facing.
- Fiberglass and Formaldehyde free.
- Meets ASTM E84, UL 723, NFPA 90A and 90B Standards.
- Thermal performance ASTM C518 $k=.27@1"$ & 900gsm



////// CAPACITY AND EFFICIENCY RATINGS

MODELS	W42HC	W48HC	W60HC
Cooling BTUH ①	42,000	47,500	54,500
EER ②	11.0	11.0	11.0
High Temp Heating (47F) BTUH ①	39,000	42,500	52,500
COP ②	3.3	3.3	3.3
Low Temp Heating (17F) BTUH ①	24,600	25,000	33,500
COP ②	2.3	2.1	2.3

① Cooling and Heating Capacities are certified in accordance with ANSI/ARI Standard 390-2003.

② EER = Energy Efficiency Ratio. COP = Coefficient of Performance. Energy efficiency data is certified in accordance with ANSI/ARI Standard 390-2003.

////// SPECIFICATIONS 3-1/2 TON THROUGH 5 TON

MODELS	W42HC-A	W42HC-B	W42HC-C	W48HC-A	W48HC-B	W48HC-C
Electrical Rating – 60 Hz	230/208 - 1	230/208-3	460 - 3	230/208 - 1	230/208 - 3	460 - 3
Operating Voltage Range	197-253	197-253	414-506	197-253	197-253	414-506
Compressor--Circuit A						
Voltage	230/208	230/208	460	230/208	230/208	460
Rated Load Amps	17.2/19.3	11.8/13.2	6.0	16.0/18.6	10.1/11.7	5.3
Branch Circuit Selection Current	19.9	13.6	6.1	21.8	13.8	6.3
Lock Rotor Amps	109/109	83.1/83.1	41	117/117	83.1/83.1	41
Compressor Type	Scroll	Scroll	Scroll	Scroll	Scroll	Scroll
Fan Motor & Condenser						
Fan Motor--HP--RPM	1/3	1/3	1/3	1/3	1/3	1/3
Fan Motor--Amps	2.4	2.4	1.0	2.4	2.4	1.0
Fan--DIA/CFM	24" - 2900	24" - 2900	24" - 2900	24" - 3000	24" - 3000	24" - 3000
Blower Motor & Evap.						
Blower Motor--HP-SPD	1/2 ECM	1/2 ECM	1/2 ECM	3/4 ECM	3/4 ECM	3/4 ECM
Blower Motor--Amps	2.4	2.4	1.2	3.3	3.3	1.7
Motor Type	Constant Torque ECM	Constant Torque ECM	Constant Torque ECM	Constant Torque ECM	Constant Torque ECM	Constant Torque ECM
CFM Cooling & E.S.P. w/Filter (Rated-Wet Coil)	1350 - .15	1350 - .15	1350 - .15	1550 - .20	1550 - .20	1550 - .20
Filter Sizes (inches) STD., 2 required	20x20x1	20x20x1	20x20x1	20x20x1	20x20x1	20x20x1
Basic Unit Weight-LBS.	500	500	500	505	505	505
Barometric Fresh Air Damper (X)	13	13	13	13	13	13
Barometric Damper w/ Exhaust (A)	16	16	16	16	16	16
Blank-Off Plate (B)	14	14	14	14	14	14
Commercial Room Ventilator (M, V)	42	42	42	42	42	42
Economizer (D, Y, Z)	44	44	44	44	44	44
Energy Recovery Ventilator (R)	87	87	87	87	87	87

MODELS	W60HC-A	W60HC-B	W60HC-C
Electrical Rating – 60 Hz	230/208 - 1	230/208 - 3	460 - 3
Operating Voltage Range	197-253	197-253	414-506
Compressor--Circuit A			
Voltage	230/208	230/208	460
Rated Load Amps	20.3/23.0	13.4/15.1	7.4
Branch Circuit Selection Current	24.4	16.0	7.8
Lock Rotor Amps	144.2/144.2	110/110	52
Compressor Type	Scroll	Scroll	Scroll
Fan Motor & Condenser			
Fan Motor--HP--RPM	1/3	1/3	1/3
Fan Motor--Amps	2.4	2.4	1.0
Fan--DIA/CFM	24" - 3100	24" - 3100	24" - 3100
Blower Motor & Evap.			
Blower Motor--HP-SPD	3/4 ECM	3/4 ECM	3/4 ECM
Blower Motor--Amps	3.8	3.8	1.7
Motor Type	Constant Torque ECM	Constant Torque ECM	Constant Torque ECM
CFM Cooling & E.S.P. w/Filter (Rated-Wet Coil)	1750 - .20	1750 - .20	1750 - .20
Filter Sizes (inches) STD., 2 required	20x20x1	20x20x1	20x20x1
Basic Unit Weight-LBS.	515	515	515
Barometric Fresh Air Damper (X)	13	13	13
Barometric Damper w/ Exhaust (A)	16	16	16
Blank-Off Plate (B)	14	14	14
Commercial Room Ventilator (M, V)	42	42	42
Economizer (D, Y, Z)	44	44	44

OPTIONAL SHIPPING CRATES

Optional crates are available to help protect your valuable WALL MOUNT investment during shipping. Constructed from OSB sheathing with steel corner posts, and sized for standard truck transportation. Treated for pests in accordance with the International Plant Protection Convention, Publication 15, Annex 1. Packaging is acceptable for international shipments.

CRATE NO.	UNITS USING CRATE	DESCRIPTION
8620-304	W42HC, W48HC	Standard Unit Crate
8620-305	W60HC	Standard Unit Crate

COOLING APPLICATION DATA - OUTDOOR TEMPERATURE ① ②

MODEL	RETURN AIR (DB/WB)	COOLING CAPACITY	75°F	80°F	85°F	90°F	95°F	100°F	105°F	110°F	115°F	120°F	125°F
W42HC	75/62	Total Cooling	44600	42500	40500	38500	36600	34800	33100	31300	29700	28000	26400
		Sensible Cooling	35300	34000	32900	31800	30800	30000	29100	28400	27600	27100	26400
	80/67	Total Cooling	47600	46300	44900	43500	42000	40500	39000	37300	35700	33900	32100
		Sensible Cooling	34200	33300	32600	31800	31100	30500	29800	29300	28700	28300	27800
	85/72	Total Cooling	56700	54100	51600	49100	46700	44300	42100	39700	37500	35200	33000
		Sensible Cooling	35000	33800	32800	31600	30500	29500	28400	27500	26500	25600	24600
W48HC	75/62	Total Cooling	54100	50500	47200	44200	41400	38800	36500	34300	32300	30500	28800
		Sensible Cooling	41600	40000	38500	37100	35800	34600	33500	32600	31700	30500	28800
	80/67	Total Cooling	57700	55000	52400	49900	47500	45200	43000	40900	38900	36900	35100
		Sensible Cooling	40300	39200	38100	37100	36100	35200	34400	33700	33000	32400	31800
	85/72	Total Cooling	68700	64300	60200	56300	52800	49500	46400	43500	40900	38400	36100
		Sensible Cooling	41300	39800	38300	36900	35400	34100	32800	31600	30400	29300	28200
W60HC	75/62	Total Cooling	58100	55300	52600	50000	47500	45200	42800	40600	38500	36400	34400
		Sensible Cooling	45700	44500	43300	42100	41000	40000	39000	37900	37000	36100	34400
	80/67	Total Cooling	62000	60200	58400	56500	54500	52600	50500	48400	46300	44100	41900
		Sensible Cooling	44300	43600	42900	42100	41400	40700	40000	39200	38500	37800	37000
	85/72	Total Cooling	73900	70400	67100	63800	60500	57500	54500	51500	48700	45800	43100
		Sensible Cooling	45400	44300	43100	41800	40600	39400	38100	36800	35500	34200	32700

- ① Low ambient control allows for compressor operation down to 0°F.
 ② Outdoor temperatures shown are measured at the condenser section air inlet.
 ③ Return air temperature °F.

CAPACITY MULTIPLIER FACTORS			
% of Rated Airflow	-10	Rated	+10
Total BTUH	0.975	1.0	1.02
Sensible BTUH	0.950	1.0	1.05

HEATING APPLICATION RATING AND OUTDOOR TEMPERATURE °F ① ②

MODEL		0°F	5°F	10°F	15°F	20°F	25°F	30°F	35°F	40°F	45°F	50°F	55°F	60°F	65°F
W42HC	BTUH	18600	20300	22000	23900	25900	28000	30200	32500	34900	37400	40100	42800	45700	48600
	WATTS	3020	3040	3070	3100	3130	3160	3200	3250	3290	3350	3400	3460	3530	3600
	COP	1.805	1.957	2.100	2.259	2.425	2.597	2.766	2.931	3.109	3.272	3.457	3.625	3.794	3.956
W48HC	BTUH	18600	20300	22200	24300	26500	28900	31400	34200	37100	40100	43400	46800	50400	54200
	WATTS	3330	3350	3380	3420	3460	3500	3550	3600	3660	3720	3790	3860	3930	4010
	COP	1.637	1.776	1.925	2.082	2.245	2.420	2.592	2.784	2.971	3.159	3.356	3.553	3.758	3.961
W60HC	BTUH	25300	27500	29800	32200	34800	37600	40400	43400	46500	49700	53100	56600	60300	64000
	WATTS	3920	4000	4080	4160	4240	4310	4380	4450	4520	4580	4640	4700	4760	4820
	COP	1.892	2.015	2.141	2.268	2.405	2.557	2.703	2.858	3.015	3.180	3.354	3.529	3.713	3.891

Performance given for 70°F DB indoor return air at rated CFM. Data includes defrost operation below 45° outdoor temperature.

- ① Supplemental Electric heaters are recommended for applications requiring heating below a 15°F outdoor temperature.
 ② Outdoor temperatures shown are measured at the condenser section air inlet.

R410A UNIT CHARGE RATES

UNIT	STD. UNIT - LBS.	DEHUM. UNITS - LBS.
W42HC	7.625	7.625
W48HC	9.750	9.5
W60HC	10.750	10.1875

INDOOR AIRFLOW CFM @ STATIC PRESSURES - EC BLOWER CONSTANT TORQUE MOTOR WITH ADJUSTMENT SPEEDS

ESP	W42HC BLOWER TAPS - DRY/WET COIL CFM					W48HC BLOWER TAPS - DRY/WET COIL CFM				
In H2O	Blower and Vent Only	Speed Tap 2	Default LO Cooling and Heating	Optional MED Cooling and Heating	Optional HI Cooling and Heating	Blower and Vent Only	Speed Tap 2	Default LO Cooling and Heating	Optional MED Cooling and Heating	Optional HI Cooling and Heating
0"	1575/1460	1205/1065	1575/1460	1745/1640	1815/1690	1745/1665	1320/1270	1745/1665	1895/1800	1985/1860
.1"	1485/1400	1050/955	1485/1400	1665/1560	1740/1630	1700/1615	1225/1160	1700/1615	1850/1760	1915/1810
.15"	1440/1360	980/900	1440/1360	1625/1520	1705/1600	1675/1585	1180/1110	1675/1585	1825/1735	1880/1780
.2"	1400/1325	915/845	1400/1325	1585/1485	1665/1570	1650/1555	1130/1060	1650/1555	1795/1705	1845/1755
.3"	1315/1235	Not Used	1315/1235	1510/1415	1590/1500	1580/1480	Not Used	1580/1480	1735/1640	1780/1690
.4"	1240/1140	Not Used	1240/1140	1435/1345	1515/1430	1500/1400	Not Used	1500/1400	1665/1565	1715/1620
.5"	1165/1030	Not Used	1165/1030	1360/1275	1435/1355	1410/1305	Not Used	1410/1305	1595/1480	1655/1545

ESP	W60HC BLOWER TAPS - DRY/WET COIL CF				
In H2O	Blower and Vent Only	Speed Tap 2	Default LO Cooling and Heating	Optional MED Cooling and Heating	Optional HI Cooling and Heating
0"	1985/1890	1485/1490	1985/1890	2075/2005	2165/2030
.1"	1920/1830	1430/1365	1920/1830	2015/1950	2085/1985
.15"	1890/1800	1400/1305	1890/1800	1985/1920	2050/1960
.2"	1855/1765	1360/1250	1855/1765	1955/1885	2015/1935
.3"	1785/1690	Not Used	1785/1690	1890/1820	1955/1880
.4"	1715/1605	Not Used	1715/1605	1825/1750	1900/1820

Above data is with 1" standard throwaway filter and 1" washable filter.
 For optional 2" pleated filter - reduce ESP by .15in.
 See installation instructions for maximum ESP information on various KW application.

Five factory programmed speed taps (torque settings) are available for the indoor blower motor, and are selected through different unit modes of operation. These modes are energized by 24VAC signals from the low voltage terminal block located inside the control panel by a thermostat or other controlling device.

1. Blower and Ventilation Only Speed is the CFM amount for continuous fan and ventilation without a call for cooling.
2. Speed Tap 2 is not used.
3. Default LO Cooling and Heating Speed is the indoor CFM amount for cooling operation using the default blower speed tap selection. This speed is labeled as LO on the speed selection terminal strip inside the unit control panel. All units ship with cooling and heating operation at LO cooling and heating speed, and provides the optimal airflow amount for normal use.
4. Optional MED Cooling and Heating Speed is selected manually during unit setup and provides a higher indoor CFM for hi static duct applications and increased airflow. This speed is labeled as MED on the speed selection terminal strip inside the unit control panel.
5. Optional HI Cooling and Heating Speed is selected manually during unit setup and provides the highest allowable indoor CFM amount. Not recommended for standard unit operation. This speed is labeled as HI on the speed selection terminal strip inside the unit control panel.

////// ELECTRICAL SPECIFICATIONS — W**HC SERIES

MODEL	Rated Volts & Phase	No. Field Power Circuits	Single Circuit				Dual Circuit							
			① Minimum Circuit Ampacity	② Maximum External Fuse or Ckt. Brkr.	③ Field Power Wire Size	④ Ground Wire	① Minimum Circuit Ampacity		② Maximum External Fuse or Ckt. Breaker		③ Field Power Wire Size		④ Ground Wire Size	
							Ckt. A	Ckt. B	Ckt. A	Ckt. B	Ckt. A	Ckt. B	Ckt. A	Ckt. B
W42HC-A00, A0Z A04 A05 A10 ④ A15	230/208-1	1	32	45	8	10								
		1	53	60	6	10								
		1	58	60	6	10								
		1 or 2	84	90	4	8	32	52	50	60	8	6	10	10
		1 or 2	84	90	4	8	58	26	60	45	6	8	10	10
W42HC-B00, B0Z B05 B09 ③ B15	230/208-3	1	24	35	8	10								
		1	39	45	8	10								
		1	51	60	6	10								
		1	51	60	6	10								
W42HC-C00, C0Z C05 C09 ③ C15	460-3	1	12	15	14	14								
		1	21	25	10	10								
		1	25	30	10	10								
		1	26	30	10	10								
W48HC-A00, A0Z A04 A05 A10 ④ A15 ④ A20	230/208-1	1	35	50	8	10								
		1	56	60	6	10								
		1 or 2	61	70	6	8	35	26	40	30	8	10	10	10
		1 or 2	87	90	3	8	35	52	50	60	8	6	10	10
		1 or 2	87	90	3	8	35	52	50	60	8	6	10	10
		1 or 2	110	125	2	6	58	52	60	60	6	6	10	10
W48HC-B00, B0Z B05 B09 ③ B15 ③ B18	230/208-3	1	25	35	8	10								
		1	40	50	8	10								
		1	52	60	6	10								
		1	53	60	6	10								
		2	N/A	N/A	N/A	N/A	52	28	60	30	6	10	10	10
W48HC-C00, C0Z C05 C09 ③ C15	460-3	1	12	15	14	14								
		1	20	25	10	10								
		1	25	30	10	10								
		1	26	30	10	10								
W60HC-A00, A0Z A05 A10 ④ A15 ④ A20	230/208-1	1	42	60	8	10								
		1 or 2	67	80	4	8	41	26	50	30	8	10	10	10
		1 or 2	93	100	3	8	41	52	50	60	8	6	10	10
		1 or 2	93	100	3	8	41	52	60	60	8	6	10	10
		1 or 2	112	125	2	6	60	52	60	60	6	6	10	10
W60HC-B00, B0Z B09 ③ B15 ③ B18	230/208-3	1	29	40	8	10								
		1	56	60	6	10								
		1	56	60	6	10								
		2	N/A	N/A	N/A	N/A	55	28	60	30	6	10	10	10
W60HC-C00, C0Z C09 ③ C15	460-3	1	14	20	12	12								
		1	28	30	10	10								
		1	28	30	10	10								

(1) The "Minimum Circuit Ampacity" values are to be used for sizing the field power conductors. Refer to the National Electrical Code (latest version), Article 310 for power conductor sizing.

CAUTION: When more than one field power circuit is run through one conduit, the conductors must be derated. Pay special attention to note 8 of Table 310 regarding Ampacity Adjustment Factors when more than three (3) conductors are in a raceway.

(2) Maximum size of the time delay fuse or circuit breaker for protection of field wiring conductors.

(3) Maximum KW that can operate with the heat pump on is 9KW. Full heat available during emergency heat mode.

(4) Maximum KW that can operate with the heat pump on is 10KW. Full heat available during emergency heat mode.

(5) Based on 75°C copper wire. All wiring must conform to the National Electrical Code and all local codes.

IMPORTANT: While this electrical data is presented as a guide, it is important to electrically connect properly sized fuses & conductor wires in accordance with the National Electrical Code & all local codes.

NOTE: MOCP (Maximum Overcurrent Protection) value listed is the maximum value as per UL 1995 calculations for MOCP (branch-circuit conductor sizes in this chart are based on this MOCP). The actual factory installed Overcurrent Protective Device (Circuit Breaker) in this model may be lower than the maximum UL 1995 allowable MOCP value, but still above the UL 1995 minimum calculated value or Minimum Circuit Ampacity (MCA) listed.

////// ELECTRICAL SPECIFICATIONS — W**HCD DEHUM SERIES

MODEL	Rated Volts & Phase	No. Field Power Circuits	Single Circuit				Dual Circuit								
			① Minimum Circuit Ampacity	② Maximum External Fuse or Ckt. Brkr.	③ Field Power Wire Size	④ Ground Wire	① Minimum Circuit Ampacity		② Maximum External Fuse or Ckt. Breaker		③ Field Power Wire Size		④ Ground Wire Size		
							Ckt. A	Ckt. B	Ckt. A	Ckt. B	Ckt. A	Ckt. B	Ckt. A	Ckt. B	
W42HCDA00, A0Z A05 A10 A15	230/208-1	1	34	45	8	10									
		1	60	60	6	10									
		1 or 2	86	90	3	8	34	52	40	60	8	6	10	10	
		1 or 2	86	90	3	8	34	52	40	60	8	6	10	10	
W42HCDB00, B0Z B05 B09 B15	230/208-3	1	25	35	8	10									
		1	41	45	8	10									
		1	53	60	6	10									
		1	53	60	6	10									
W42HCDC00, C0Z C05 C09 C15	460-3	1	12	15	14	14									
		1	20	20	12	12									
		1	26	30	10	10									
		1	26	30	10	10									
W48HCDA00, A0Z A05 A10 A15	230/208-1	1	35	50	8	10									
		1 or 2	61	70	6	8	35	26	45	30	8	10	10	10	
		1 or 2	87	90	3	8	35	52	50	60	8	6	10	10	
		1 or 2	87	90	3	8	35	52	50	60	8	6	10	10	
W48HCDB00, B0Z B05 B09 B15	230/208-3	1	25	35	8	10									
		1	40	50	8	10									
		1	52	60	6	10									
		1	53	60	6	10									
W48HCDC00, C0Z C05 C09 C15	460-3	1	12	15	14	14									
		1	21	25	10	10									
		1	26	30	10	10									
		1	27	30	10	10									
W60HCDA00, A0Z A05 A10 A15	230/208-1	1	41	60	8	10									
		1 or 2	67	80	4	8	41	26	50	30	8	10	10	10	
		1 or 2	93	100	3	8	41	52	50	60	8	6	10	10	
		1 or 2	93	100	3	8	41	52	50	60	8	6	10	10	
W60HCDB00, B0Z B09 B15	230/208-3	1	28	40	8	10									
		1	55	60	6	10									
		1	55	60	6	10									
		1	55	60	6	10									
W60HCDC00, C0Z C09 C15	460-3	1	14	20	12	12									
		1	28	30	10	10									
		1	28	30	10	10									
		1	28	30	10	10									

(1) The "Minimum Circuit Ampacity" values are to be used for sizing the field power conductors. Refer to the National Electrical Code (latest version), Article 310 for power conductor sizing.

CAUTION: When more than one field power circuit is run through one conduit, the conductors must be derated. Pay special attention to note 8 of Table 310 regarding Ampacity Adjustment Factors when more than three (3) conductors are in a raceway.

(2) Maximum size of the time delay fuse or circuit breaker for protection of field wiring conductors.

(3) Maximum KW that can operate with the heat pump on is 9KW. Full heat available during emergency heat mode.

(4) Maximum KW that can operate with the heat pump on is 10KW. Full heat available during emergency heat mode.

(5) Based on 75°C copper wire. All wiring must conform to the National Electrical Code and all local codes.

IMPORTANT: While this electrical data is presented as a guide, it is important to electrically connect properly sized fuses & conductor wires in accordance with the National Electrical Code & all local codes.

NOTE: MOCP (Maximum Overcurrent Protection) value listed is the maximum value as per UL 1995 calculations for MOCP (branch-circuit conductor sizes in this chart are based on this MOCP). The actual factory installed Overcurrent Protective Device (Circuit Breaker) in this model may be lower than the maximum UL 1995 allowable MOCP value, but still above the UL 1995 minimum calculated value or Minimum Circuit Ampacity (MCA) listed.

////// SOUND DATA - DBA @ 5 FT. AND 10 FT.*

DUCT FREE	INDOOR COOLING OPERATION @ 5 FT.				INDOOR COOLING OPERATION @ 10 FT.				OUTDOOR @ 5 FT.
Unit	Standard Grilles	With WMSC5	With WMSC5 and WAPR-11	WMSC5, WARP-11, WAPFB51	Standard Grilles	With WMSC5	With WMSC5 and WAPR-11	WMSC5, WARP-11, WAPFB51	Standard Features
W42HC	56.1	53.1	51.1	50.3	51.7	50.7	51	49.6	73.7
W48HC	57	49.1	48.6	45.6	52.7	48.7	47.5	47.4	73.6
W60HC	56.5	52	48.4	47.4	53.3	49.7	47.4	46.5	71.4

DUCTED SUPPLY	INDOOR COOLING OPERATION @ 5 FT.			INDOOR COOLING OPERATION @ 10 FT.			OUTDOOR @ 10 FT.
Unit	Standard Grilles	With WMSC5	With WMSC5 and WAPR-11	Standard Grilles	With WMSC5	With WMSC5 and WAPR-11	Standard Features
W42HC	56.3	53.2	50.4	51.1	51.4	50.7	68.6
W48HC	57.8	49.8	46.4	52.8	49.8	44.7	69
W60HC	56	47.1	46.6	52.7	47.1	44.8	66.8

Integrated values calculated per ANSI/ASA S12.60-2009/Part 2, Section 5.2.2.1, Integrated Sound Vales are also applicable for use in learning spaces for LEED schools; EQ Prerequisite 3 - Minimum Acoustical Performance, OPTION 1. Using methods prescribed in ANSI S12.60, classroom must achieve a maximum background noise level of 45 dBA. Results Referenced Were Recorded In The Bard Manufacturing Company, Inc. Sound Lab Facility. Actual Field Application Results May Vary With Classroom Design and Construction Methods.

////// HEATER PACKAGES - FIELD INSTALLED W**HC SERIES UNITS

• Designed for adding Electric Heat to 0 KW Units			• ETL US & Canada Listed			
• Circuit Breaker Standard on 230/208V Models			• Toggle Disconnect Standard on 460V Models			
Air Conditioner Models	-A00 Models 230/208-1		-B00 Models 230/208-3		-C00 Models 460-3	
	Heater Model #	KW	Heater Model #	KW	Heater Model #	KW
W42HC	WMCBC-07A	02	WMCBC-05B	02	WMCBC-06C	02
	EHW3HC-A04	04	EHW3HC-B05	05	EHW3HC-C05	05
	EHW3HC-A05	05	EHW3HC-B09	09	EHW3HCDC09	09
	EHW6HCDA10	10	EHW3HC-B15	15	EHW3HC-C15	15
	EHW3HC-A15	15				
W48HC	WMCBC-08A	02	WMCBC-05B	02	WMCBC-06C	02
	EHW4HC-A04	04	EHW3HC-B05	05	EHW4HC-C05	05
	EHW4HC-A05	05	EHW4HC-B09	09	EHW4HC-C09	09
	EHW6HCDA10	10	EHW4HC-B15	15	EHW4HC-C15	15
	EHW4HC-A15	15	EHW4HC-B18	18		
	EHW4HC-A20	20				
W60HC	WMCBC-09A	02	WMCBC-06B	02	WMCBC-06C	02
	EHW6HCDA05	05	EHW6HC-B09	09	EHW6HC-C09	09
	EHW6HCDA10	10	EHW6HC-B15	15	EHW4HC-C15	15
	EHW6HC-A15	15	EHW6HC-B18	18		
	EHW6HC-A20	20				

////// **ELECTRIC HEAT TABLE - REFER TO ELECTRICAL SPECIFICATIONS FOR AVAILABILITY BY UNIT MODEL**

NOMINAL KW	AT 240V (1)				AT 208V (1)				AT 480V (2)			AT 460V (2)		
	KW	1-PH AMPS	3-PH AMPS	BTUH	KW	1-PH AMPS	3-PH AMPS	BTUH	KW	3-PH AMPS	BTUH	KW	3-PH AMPS	BTUH
4.0	4.0	16.7		13,652	3.00	14.4		10,239						
5.0	5.0	20.8	12.5	17,065	3.75	18.0	10.4	12,799						
6.0	6.0		14.4	20,478	4.50		12.5	15,359	6.0	7.2	20,478	5.52	6.9	18,840
8.0	8.0	33.3		27,304	6.00	28.8		20,478						
9.0	9.0		21.7	30,717	6.75		18.7	23,038	9.0	10.8	30,717	8.28	10.4	28,260
10.0	10.0	41.7		34,130	7.50	36.1		25,598						
15.0	15.0	62.5	36.1	51,195	11.25	54.1	31.2	38,396	15.0	18.0	51,195	13.80	17.3	47,099
18.0	18.0		43.3	61,434	13.50		37.5	46,076	18.0	21.7	61,434	16.56	20.8	56,519
20.0	20.0	83.3		68,260	15.00	72.1		51,195						

(1) These electric heaters are available in 230/208V units only.

(2) These electric heaters are available in 480V units only.

////// **WALL MOUNT™ VENTILATION OPTION SELECTION CHART**

VENT CODE	FIELD INSTALL KIT	UNIT	OPERATION	DESCRIPTION
X	FAD-NE5	W42HC, W48HC, W60HC	Barometric	Air damper provides slight positive room pressure during blower operation, No room air exhaust.
A	FAD-BE5	W42HC, W48HC, W60HC	Barometric	Air damper provides slight positive room pressure during blower operation, barometric room air exhaust.
B	BOP5	W42HC, W48HC, W60HC	No Ventilation	Insulated plates used to seal vent intake and exhaust openings.
M	CRV-F5	W42HC, W48HC, W60HC	24V On/Off	Vent Provides motorized spring return on/off operation to bring in outdoor air and exhaust room air. No intake hood required.
V	CRV-V5	W42HC, W48HC, W60HC	24V On/Off, 2-10V	Vent provides motorized spring return modulating or on/off operation to bring in outdoor air and exhaust room air. Minimum and occupied vent blade positions. No intake hood required.
D	ECON-NC5	W42HC, W48HC, W60HC	2-10V only	Full flow Economizer that uses 2 to 10V signal from a DDC control system or thermostat.
Z	ECON-WD5	W42HC, W48HC, W60HC	JADE Controller	Full flow Economizer that uses the JADE controller and included sensors to operate free cooling. Enthalpy operation user adjustable.
Y	ECON-DB5	W42HC, W48HC, W60HC	JADE Controller	Full flow Economizer that uses the JADE controller and included sensors to operate free cooling. Dry Bulb operation user adjustable.
R	ERV-FA5	W42HC, W48HC, W60HC	24V On/Off, 3 blower speeds	208/230V Energy Recovery ventilator with energy wheel media. 3 independently selected intake and exhaust blower speeds. No intake hood required.
	ERV-FC5	W42HC, W48HC, W60HC	24V On/Off, 3 blower speeds	460V Energy recovery ventilator with energy wheel media. 3 independently selected intake and exhaust blower speeds. No intake hood required.

“X” Vent Code Option – Standard Fresh Air Damper No Exhaust (FAD-NE)

The barometric fresh air damper without exhaust is a standard feature on all models. It is installed on the right side above the condenser intake and allows outside ventilation air, up to 25% of the total airflow rating of the unit, to be introduced through the air inlet openings and to be mixed with the conditioned air. The damper opens during blower operation and closes when the blower is off. Adjustable blade stops allow different amounts of outside air to be introduced into the building and can be easily locked closed if required. The room exhaust air path is sealed with an insulated block-off plate.



Fresh Air Damper Intake (FAD-NE and FAD-BE)

“A” Vent Code Option – Fresh Air Damper with Barometric Exhaust (FAD-BE)

The barometric fresh air damper with exhaust is an optional feature on all models. It is installed on the right unit side above the condenser intake and allows outside ventilation air, up to 25% of the total airflow rating of the unit, to be introduced through the air inlet openings and to be mixed with the conditioned air. The damper opens during blower operation and closes when the blower is off. Adjustable blade stops allow different amounts of outside air to be introduced into the building and can be easily locked closed if required. The room exhaust air path uses a barometric damper design that relieves room pressurization during outdoor air intake. The damper is located in the front of the unit below the control panel. Adjustable blade stops allow room pressure adjustment by controlling the amount of exhaust air leaving the building.



Fresh Air Damper Exhaust (FAD-BE only)

“B” Vent Code Option – Block Off Plate (BOP)

Blank off plates are installed on the inside of the service door and over the exhaust opening in the condenser partition. The plates cover the air inlet and room exhaust openings, which restricts any outside air from entering the unit or room air from leaving the conditioned space. The blank off plate option may be utilized in applications where outside air intake is not required by state or local codes.

“M” Vent Code Option – Commercial Room Ventilator with fixed blade position (CRV-F)

The built-in commercial room ventilator with fixed blade position is internally mounted behind the service door and allows outside ventilation air, up to 50% of the total airflow rating of the unit. It includes a built-in exhaust air damper for room pressurization relief. Blade stops are easily adjustable to set intake airflow. The commercial room ventilator with fixed blade position (CRV-F) is a simple and innovative approach to improving the indoor air quality by providing fresh air intake and exhaust capability. The CRV-F can be activated by indoor blower operation or independently controlled by a thermostat or controller using a 24VAC occupancy or schedule signal. Blade operation is controlled by a on/off spring return motor that closes rapidly when de-energized. Blade seals provide minimal blade leakage.

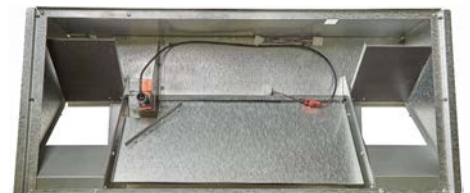

Commercial Room Ventilator-Fixed

“V” Vent Code Option – Commercial Room Ventilator with Modulating Blade position (CRV-V)

The built-in commercial room ventilator with modulating blade position is internally mounted behind the service door and allows outside ventilation air, up to 50% of the total airflow rating of the unit. It includes a built-in exhaust air damper for room pressurization relief. Blade seals allow for minimal blade leakage. A ventilation control board allows multiple blade settings to adjust intake airflow. By setting multiple blade positions, pre-purge, occupied, and unoccupied airflow amounts are possible with capable thermostats and controllers. The CRV-V also allows for 0-10V input for modulating ventilation control based on CO2 levels. Complies with ANSI/ASHRAE Standard 62.1 “Ventilation for Acceptable Indoor Air Quality” and other state and local ventilation codes that require outdoor air intake but not economizer operation.



Commercial Room Ventilator- Modulating



“V” Vent Control Board

“D” Vent Code Option – Economizer without controls installed (ECON-NC)

The built-in economizer is internally mounted behind the service door and allows outside ventilation air, up to 100% of the total airflow rating of the unit. It includes a built-in exhaust air damper for room pressurization relief. The economizer is designed to provide “free cooling” when outside air conditions are cool and dry enough to satisfy cooling requirements without running the compressor. This provides lower operating costs, extended equipment life, and cooling operation at cold (-40°F) outdoor temperatures. The ECON-NC does not contain unit ventilation controls, and provides a 0-10V Belimo actuator motor with spring return. Blade seals are used to minimize blade leakage. Controls are provided by using a field supplied DDC system, or a thermostat capable of 0-10V economizer operation. Indoor and outdoor temperature sensors are not provided with the ventilation option, and must be ordered separately.



Economizer, No Controls

“Y and Z” Vent Code Option – Economizers with JADE® Controller (ECON-WD5 and ECON-WB5)

The JADE controlled economizer is internally mounted behind the service door and allows outside ventilation air. The ECON-WD and ECON-WB allows up to 100% of the total airflow rating of the unit. It includes a built-in exhaust air damper for room pressurization relief. The economizer is designed to provide “free cooling” when outside air conditions are cool and dry enough to satisfy cooling requirements without running the compressor. This provides lower operating costs, extended equipment life, and cooling operation down to -40°F outdoor temperatures.



Economizer, Jade Control

“Y and Z” Vent Code Option – (ECON-WD and ECON-WB) JADE® Controller Information

JADE Economizer controls provide Demand Ventilation Control, operational checkout, an easy to read LCD screen, configurable freeze protection, and LCD displayed economizer component failure alarms. Minimum vent position, occupancy ventilation, and 0-10V CO2 input is available for use with select CO2 room sensors. Economizer operation can be controlled by outdoor dry bulb or outdoor enthalpy measurement. When used with a Bard economizer assembly, the JADE controller is able to meet most state and local codes for economizer use.



Jade Control Module

JADE Controller Specifications:

- Operating Humidity Range (% RH) 5 to 95% RH, non-condensing
- Contact Ratings 30 VAC-- 1.5 A Run, 3.5 A Inrush
- Voltage 20 to 30 VAC RMS
- Operating Temperature Range (F) -40 F to +150 F
- Operating Temperature Range (C) -40 C to +65 C
- Approvals, Federal Communications Commission Compliant
- Approvals, CE Compliant
- Complies with California Title 24
- Mixed air and Outdoor Enthalpy Sensor using Sylk Bus.
- Output 2-10 VDC to actuator, Sylk Bus.

“R” Vent Code Option – Energy Recovery Ventilator (ERV-F)

The wall-mount energy recovery ventilator (ERV) is a highly innovative approach to meeting indoor air quality ventilation requirements as established by ANSI/ASHRAE Standard 62.1. The ERV allows up to 400 CFM (depending upon model) of fresh air and exhaust through the unit while maintaining superior indoor comfort and humidity levels. In most cases this can be accomplished without increasing equipment sizing or operating costs. Heat transfer efficiency is up to 67% during summer and 75% during winter conditions.

The ERV consists of a unique “rotary energy recovery cassette” that provides effective sensible and latent heat transfer capabilities during summer and winter conditions. Various control schemes are addressed including limiting ventilation during building occupancy only. Outdoor air enters the front of the unit below the control panel. Room air is exhausted through the condenser partition into the condenser area. Intake and exhaust use independent blowers for intake air and exhaust air balancing. Each blower assembly has 3 speed taps for blower CFM adjustment. It can be built-in at the factory or field installed as an option. Wiring includes plug-in harnesses for easy vent installation and removal.



Energy Recovery Ventilator

Typical load reductions for ERV-F3

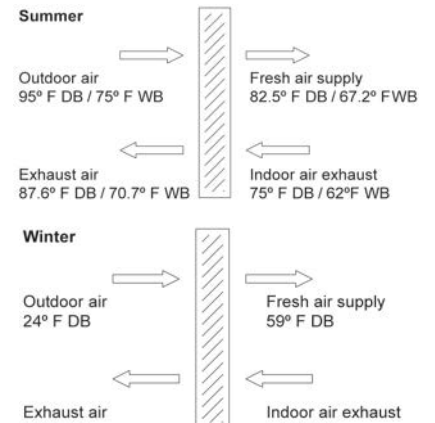

WALL MOUNT™ BAROMETRIC DAMPER (FAD) PERFORMANCE

“X” (FAD-NE5 and FAD-NE5) Barometric Damper Without Exhaust Vent Code Options

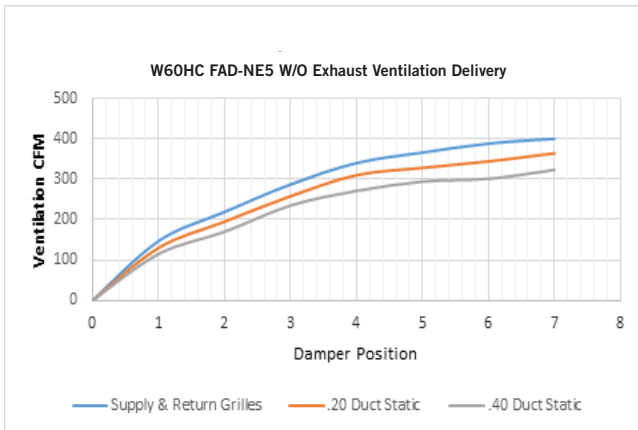
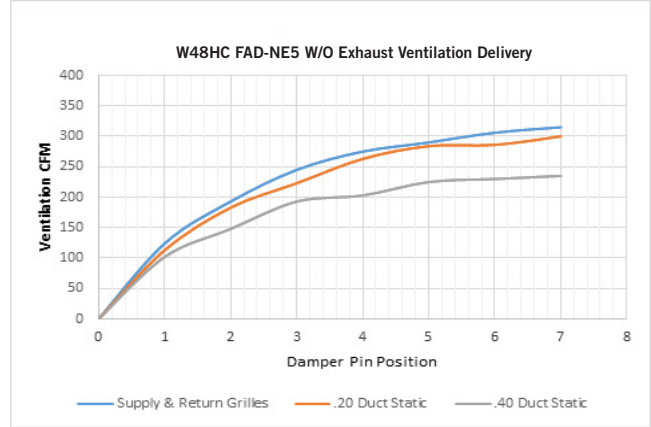
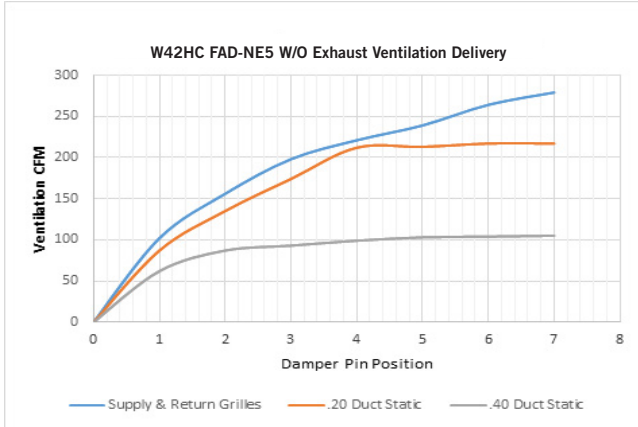

“A” (FAD-BE5 and FAD-BE5) Barometric Damper With Exhaust Vent Code Options

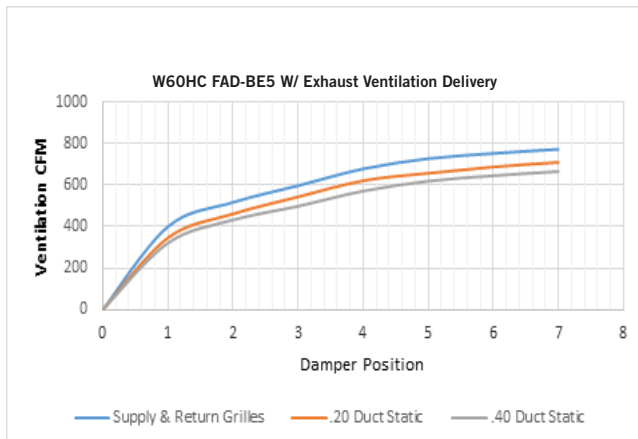
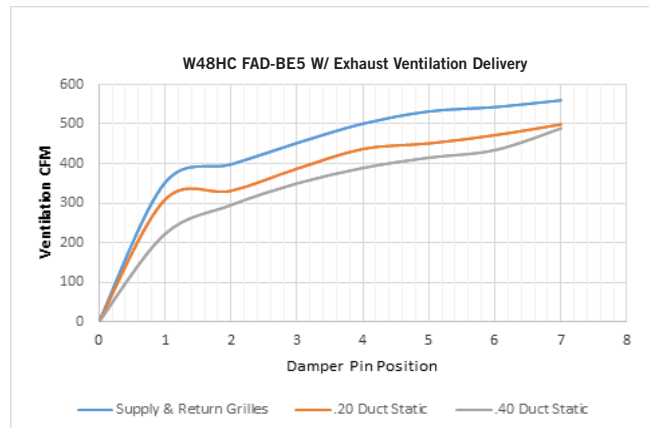
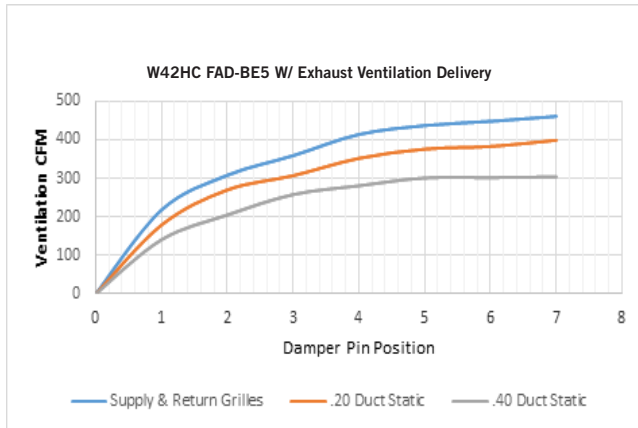

////// WALL MOUNT™ VENTILATION AIRFLOW CHARTS

“M” (CRV-F) Vent Code Options

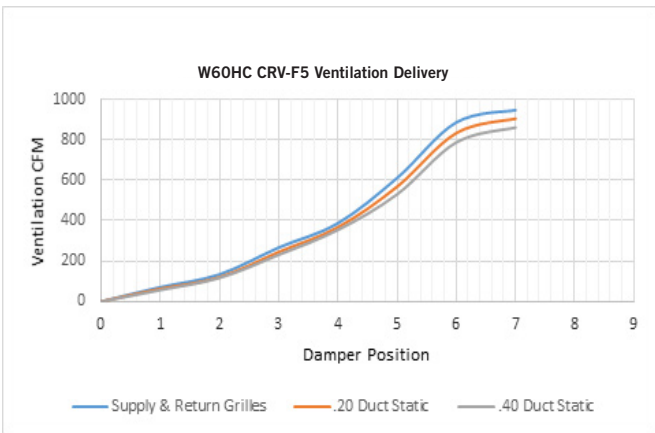
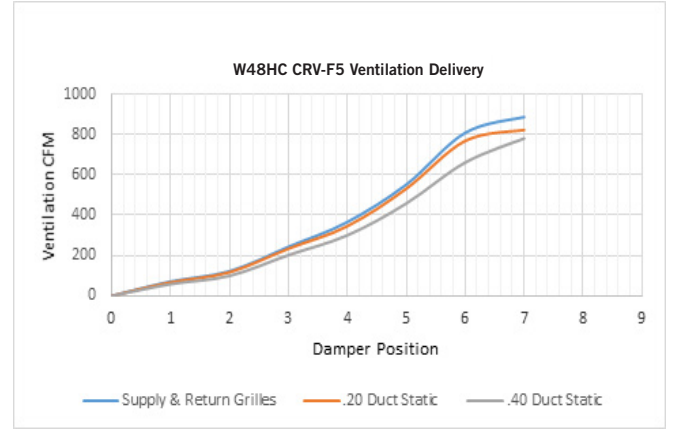
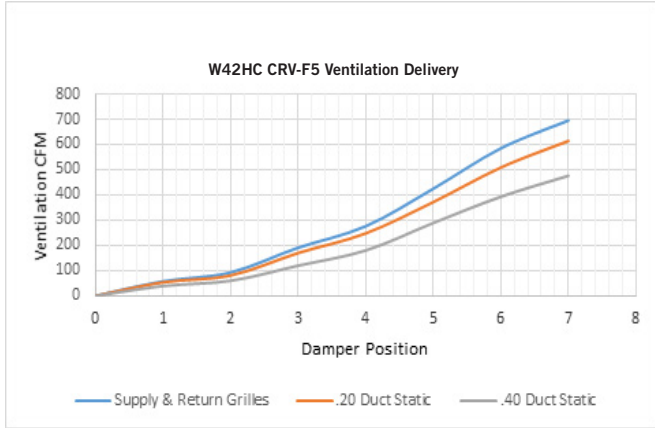

“V” (CRV-V) Vent Code Options

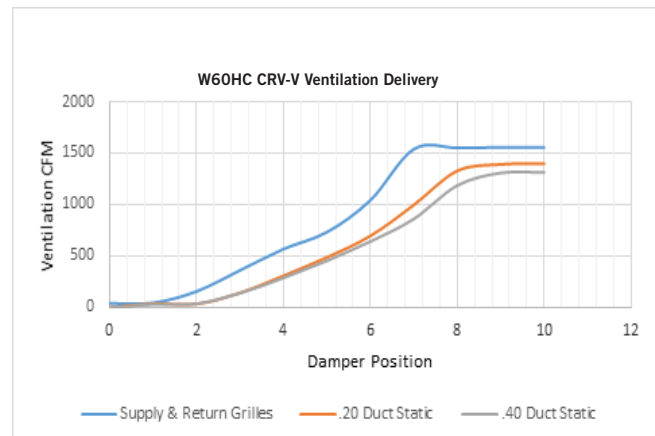
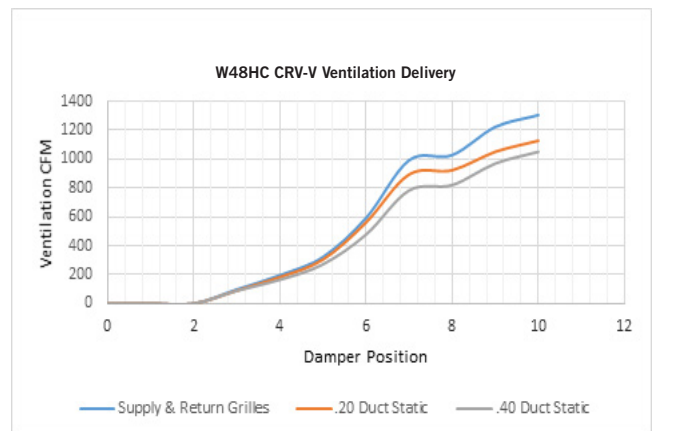
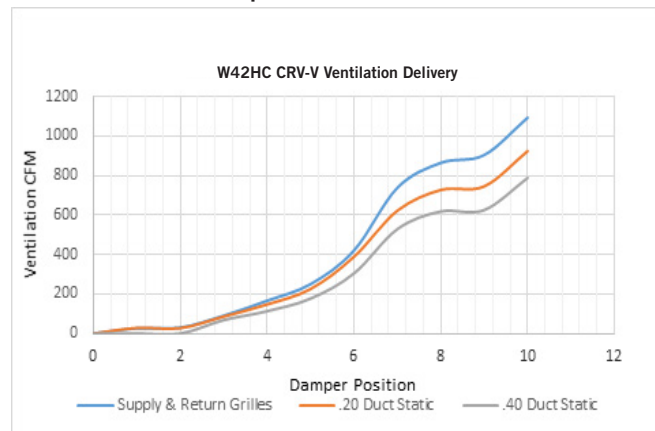

////// WALL MOUNT™ VENTILATION AIRFLOW CHARTS

“D” (ECON-NC) and “Y” (ECON-DB) and “Z” (ECON-WD) Vent Code Options

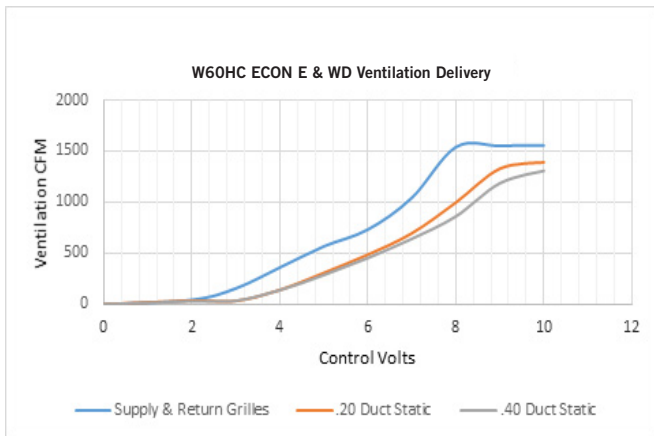
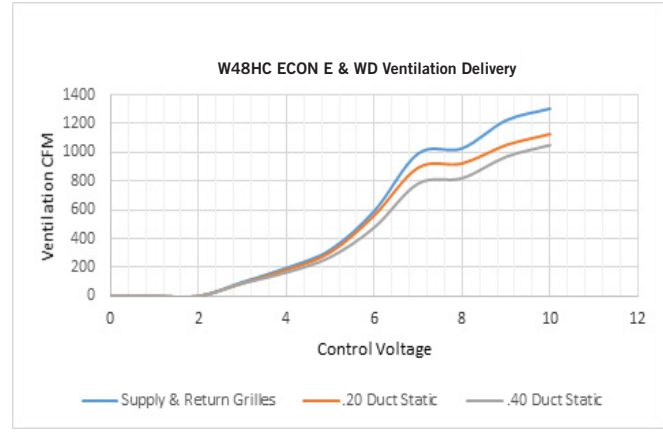
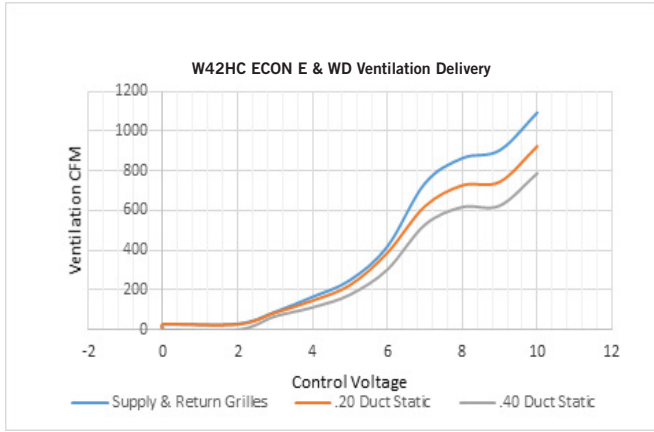

WALL MOUNT™ ENERGY RECOVERY VENTILATION (ERV) PERFORMANCE

"R" (ERV-FA5 and ERV-FC5) Vent Code Options for W42, W48, and W60
 SUMMER COOLING PERFORMANCE (INDOOR DESIGN CONDITIONS 75°DB/62°WB)

AMBIENT O.D.		VENTILATION RATE -- 450 CFM 63% EFFICIENCY						VENTILATION RATE -- 375 CFM 64% EFFICIENCY						VENTILATION RATE -- 300 CFM 65% EFFICIENCY					
DB/ WB	F	VLT	VLS	VLL	HRT	HRS	HRL	VLT	VLS	VLL	HRT	HRS	HRL	VLT	VLS	VLL	HRT	HRS	HRS
105	75	21465	14580	6884	13952	9477	4475	17887	12150	5737	11805	8018	3786	14310	9720	4590	9587	6512	3075
	70	14580	14580	0	9477	9477	0	12150	12150	0	8018	8018	0	9720	9720	0	6512	6512	0
	65	14580	14580	0	9477	9477	0	12150	12150	0	8018	8018	0	9720	9720	0	6512	6512	0
100	80	31590	12150	19440	20533	7897	12635	26325	10125	16200	17374	6682	10692	21060	8100	12960	14110	5427	8683
	75	21465	12150	9314	13952	7897	6054	17997	10125	7762	11805	6682	5123	14310	8100	6210	9587	5427	4160
	70	12352	12150	202	8029	7897	131	10293	10125	168	6793	6682	111	8235	8100	135	5517	5427	90
	65	12150	12150	0	7897	7897	0	10125	10125	0	6682	6682	0	8100	8100	0	5427	5427	0
	60	12150	12150	0	7897	7897	0	10125	10125	0	6682	6682	0	8100	8100	0	5427	5427	0
95	80	31590	9720	21870	20533	6318	14215	26325	8100	18225	17374	5345	12028	21060	6480	14580	14110	4341	9768
	75	21465	9720	11744	13952	6318	7634	17887	8100	9787	11805	5345	6459	14310	6480	7830	9587	4341	5246
	70	12352	9720	2632	8029	6318	1711	10293	8100	2193	6793	5345	1447	8235	6480	1755	5517	4341	1175
	65	9720	9720	0	6318	6318	0	8100	8100	0	5345	5345	0	6480	6480	0	4341	4341	0
	60	9720	9720	0	6318	6318	0	8100	8100	0	5345	5345	0	6480	6480	0	4341	4341	0
90	80	31590	7290	24300	20533	4738	15794	26325	6075	20250	17374	4009	13365	21060	4860	16200	14110	3256	10854
	75	21465	7290	14175	13952	4738	9213	17887	6075	11812	11805	4009	7796	14310	4860	9450	9587	3256	6331
	70	12352	7290	5062	8029	4738	3290	10293	6075	4218	6793	4009	2784	8235	4860	3375	5517	3256	2261
	65	7290	7290	0	4738	4738	0	4050	6075	0	4009	4009	0	4860	4860	0	3256	3256	0
	60	7290	7290	0	4738	4738	0	4050	6075	0	4009	4009	0	4860	4860	0	3256	3256	0
85	80	31590	4860	26730	20533	3159	17374	26325	4050	22275	17374	2672	14701	21060	3240	17820	14110	2170	11939
	75	21465	4860	16605	13952	3159	10793	17887	4050	13837	11805	2672	9132	14310	3240	11070	9587	2170	7416
	70	12352	4860	7492	8029	3159	4870	10293	4050	6243	6793	2672	4120	8235	3240	4995	5517	2170	3346
	65	4860	4860	0	3159	3159	0	4050	4050	0	2672	2672	0	3240	3240	0	2170	2170	0
	60	4860	4860	0	3159	3159	0	4050	4050	0	2672	2672	0	3240	3240	0	2170	2170	0
80	75	21465	2430	19035	13952	1580	12372	17887	2025	15862	11805	1336	10469	14310	1620	12690	9587	1085	8502
	70	12352	2430	9922	8029	1580	6449	10293	2025	8268	6793	1336	5457	8235	1620	6615	5517	1085	4432
	65	4252	2430	1822	2764	1580	1184	3543	2025	1518	2338	1336	1002	2835	1620	1215	1899	1085	814
	60	2430	2430	0	1579	1580	0	2025	2025	0	1336	1336	0	1620	1620	0	1085	1085	0
75	70	12352	0	12352	8029	0	8029	10293	0	10293	6793	0	6793	8235	0	8235	5517	0	5517
	65	4252	0	4252	2764	0	2764	3543	0	3543	2338	0	2338	2835	0	2835	1899	0	1899
	60	0	0	0	0	0	0	0	0	0	0	0	0	0	0	0	0	0	0

ERV-FA5 WINTER HEATING PERFORMANCE (INDOOR DESIGN CONDITIONS 70°F DB)

AMBIENT O.D.	VENTILATION RATE					
	450 CFM 80% EFF.		375 CFM 81% EFF.		300 CFM 82% EFF.	
DB/F	WVL	WVL	WVL	WVL	WVL	WHR
65	2430	1944	2025	1640	1620	1328
60	4860	3888	4050	3280	3240	2656
55	7290	5832	6075	4920	4860	3985
50	9720	7776	8100	6561	6480	5313
45	12150	9720	10125	8201	8100	6642
40	14580	11664	12150	9841	9720	7970
35	17010	13608	14175	11481	11340	9298
30	19440	15552	16200	13122	12960	10627
25	21870	17496	18225	14762	14580	11955
20	24300	19440	20250	16402	16200	13284
15	26730	21384	22275	18042	17820	14612

LEGEND:

- VLT = Ventilation Load - Total
- VLS = Ventilation Load - Sensible
- VLL = Ventilation Load - Latent
- HRT = Heat Recovery - Total
- HRS = Heat Recovery - Sensible
- HRL = Heat Recovery - Latent
- WVL = Winter Ventilation Load
- WHR = Winter Heat Recovery

NOTE: Sensible performance only is shown for winter application.

Cabinet Finish Options

Unit models are available in Beige, White, Buckeye Gray, Desert Brown, Dark Bronze, Stainless Steel, and Aluminum. Painted cabinet construction is comprised of 20 gauge Zinc coated steel. Cabinet Panels are cleaned, rinsed, sealed, and dried before a polyurethane primer is applied. The cabinet coating is completed with a baked on textured enamel. The resulting finish is designed to withstand 1000 hours of salt spray tests per ASTM B117-03.

Stainless steel external cabinet construction is comprised of 316 grade materials. Stainless steel screws and fasteners are used in all externally exposed areas. A corrosion resistant coated fan blade and stainless steel condenser motor mount is provided.

Aluminum external cabinet construction is ASTM B 209 grade .06” thickness with a stucco appearance.

Stainless Steel Cabinet Construction

Exterior Stainless Steel finish cabinets are often selected for corrosion and chemical resistance. Higher grades of stainless steel are often specified to meet the requirements of harsh environments. Units may not only be exposed to wind - blown dust, dirt, lint, and fibers but also may be exposed to corrosive agents. The Bard stainless steel cabinet option offers a high quality stainless steel grade enclosure and fasteners for years of operation in these conditions.

Features:

- Sides, doors, grilles, back panels, and top are 316 grade stainless steel.
- Base, condenser partition, and fan shroud are 304 grade stainless steel.
- Stainless steel exterior cabinet screws, washers, nuts, and bolts, are used.
- Stainless steel outdoor motor mount and motor mount hardware.
- Compressor mounting hardware is stainless steel and hex no-spin rivet nuts are used in the unit base.
- Corrosion resistant coating is applied to fan blade.

Bard highly suggests units exposed to extremely harsh environments, high quantities of airborne dirt and dust, or sprayed with water hose and splashing water be ordered with the Blank Off Plate (BOP) ventilation option unless codes require fresh air intake. The BOP ventilation option installs plates over the fresh air intake and exhaust openings.

Green Fin Hydrophilic Evaporator Coils Standard On All Units

Bard WALL MOUNT products include a green protective coating applied to the aluminum fin stock used for the evaporator coil. The evaporator coil coating is hydrophilic (attracts water) and allows for proper condensate drainage along with mild corrosion protection. Resistance to corrosive agents include ammonia, sodium hydroxide, sodium chloride, acidic solutions and solvents.

Note: The green fin hydrophilic evaporator coil is not a replacement for technicoat coilcoating. Green fin stock does provide additional coil protection, but technicoat is recommended for harsh indoor environments where strong acidic or alkali chemicals are being used.



X—Beige

1—White



4—Gray

5—Desert



8—Bronze

S—Stainless



A—Aluminum



Hydrophilic Green Coil (standard)

OPTIONAL DIP COATED EVAPORATOR AND CONDENSER COIL

Bard now offers TECHNICOAT AA, a robust dipped coating option for the evaporator and condenser coil. TECHNICOAT AA has passed all HVAC accelerated tests like salt spray, flexibility and SWAAT 3,000+ hours. It has been tested in the field in the most severe industrial exposure conditions, such as a coastal refinery in Saudi Arabia, mining facilities in central Africa, and various Pacific islands. TECHNICOAT AA did not show any deterioration after multiple years of function with coils directly exposed to such harsh environmental conditions. The TECHNICOAT AA coating system is based on modified acrylic waterborne binders with high elongation properties. Aluminum pigmentation has been added to establish exceptional heat transfer, chemical resistance, and UV blocking properties. Corrosion resistance reaches >10,000+ hours in ASTM B-117 and >3,120 hours in SWAAT testing. Coating is gray in color.

TEMPERATURE RESISTANCE:

- Maximum up to 248°F (120°C), 480°F (250°C) peak exposure
- Minimum -40°F (-40°C)

CHEMICAL RESISTANCE:

- Alkalines including Ammoniac solution, Potassium Hydroxide, Calcium Hydroxide, and Magnesium Hydroxide.
- Alcohols including Isopropanol, Butanol, Amyl Alcohol, Benzyl Alcohol, Diacetone Alcohol, Glycerine, Propanol, and Pentanol
- Aliphatic Hydrocarbons including White Spirit, Shellsol, Bitumen, Isopar G, and Paraffin.
- Amines including Triethanolamine, Aniline Sulphate, Hexamethylenetetraamine, Phenylamine, Triethylamine, and Methylamine.
- Inorganic Compounds including Hydrogen Carbonate, Hydrogen Sulfide, Nitrous Acid, Sulphuric Acid, and Selenic Acid.
- Aromatic Hydrocarbons including Xylene, Toluene, Asphalt, Anthracene, Benzapherene, Gumlac, Benzine, and Naphtha.
- Fuels and Oils including Diesel, Fuel Oil, Petrol, Super Petrol, Lubricating Oils, Kerosene, Spheric Oils, LPG, and Mineral Oil.
- Ethers including Enthrific Oils, Vegetable Oils, Butane, Acetylene, and Methane.
- Halogenated Hydrocarbons including Amyl Acetate, Propyl Acetate, Ethyl Oxalate, Butyl Acetate, and Butyl Propionate.
- Softeners including Palatinol C, Chloroparaffine 5XX, Dioctylphosphate, Desavin, Mesamol, and Dibutylphosphate.
- Organic Compounds including Benzoic Acid, Lactic Acid, Phenols, Fatty Acids, Malic Acid, and Picric Acid.
- Salts and water solutions including Sodium, Potassium, Calcium, Aluminum, Ammonium, Barium, Copper, Lead, and Lithium.
- Many other agents including Phosphor, Zinc, Glucose Syrup, Sulfur, Urea, Menthol, Antimony, Hydrogen, Rubber, and Shellac.

Contact your local Bard distributor or representative for a list of all chemicals and chemical resistance information.

SPECIAL PROPERTIES:

- Anti-Odor
- Hydrophilic / Hydrophobic
- Anti-Corrosive

EXPOSURE CONDITIONS INCLUDE:

Food Processing & Storage, Airports, Office Buildings, Hotels, Schools, Warehouses, Water Treatment, Breweries, Paper Mills, Refineries, Power Plants, Meat Processing Industries, Automotive Industries and other locations near shorelines and salt water.

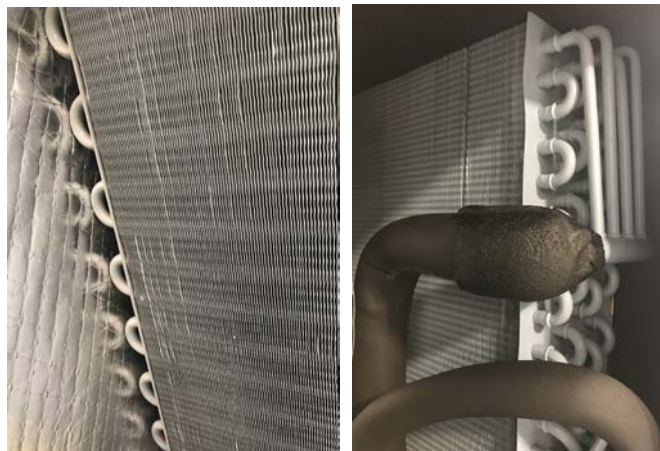

////// WALL MOUNT™ FACTORY INSTALLED CONTROLS OPTIONS

Factory installed controls are provided by Bard to enhance a WALL MOUNT product before it is shipped. All WALL MOUNT products are shipped with a auto-reset high pressure switch and an auto-reset low pressure switch to help protect refrigeration components. Heat pumps include a control board with built in time delays and diagnostic lights.

CONTROL CODE	DESCRIPTION OF FACTORY INSTALLED COMPONENTS
X	Hi Pressure Switch, Low Pressure Switch, Defrost Heat Pump Control Board.
E	Hi Pressure Switch, Low Pressure Switch, Defrost Heat Pump Control Board, Low Ambient Control
F	Hi Pressure Switch, Low Pressure Switch, Defrost Heat Pump Control Board, Low Ambient Control, Dirty Filter Press. Switch
J	Hi Pressure Switch, Low Pressure Switch, Defrost Heat Pump Control Board, Low Ambient Control, Alarm Relay
Q	Hi Pressure Switch, Low Pressure Switch, Defrost Heat Pump Control Board, Outdoor Thermostat
R	Hi Pressure Switch, Low Pressure Switch, Defrost Heat Pump Control Board, Low Ambient Control, Outdoor Thermostat
S	Hi Pressure Control, Low Pressure Switch, Defrost Heat Pump Control Board, PTCR Start Kit
T	Hi Pressure Control, Low Pressure Switch, Defrost Heat Pump Control Board, Low Ambient Control, Outdoor Thermostat, PTCR Start Kit

////// WALL MOUNT™ FIELD INSTALLED KITS

Field installed kits provide accessories that can be installed in the field. Required components, wires, enclosures, screws, and instructions that are needed are provided within the kit.

CONTROL CODE	KIT PART NO.	UNITS USING KIT	DESCRIPTION OF FIELD INSTALLED KIT
E	CMH-35	W42HC, W48HC, W60HC	Low Ambient Control allows compressor cooling between 0°F and 50°F outdoor temp. - fan cycling
NA	CMC-32	W42HC, W48HC, W60HC	PTCR Start Kit. Increases starting torque by 2 to 3x. 230V-60hz-1 phase (A voltage) only. Cannot be used in combination with SK start kit
NA	SK111	W42HC, W48HC, W60HC	Start Capacitor and Potential Relay Start Kit. Increases starting torque by 9x. 230V-60hz-1 phase (A voltage) only. Cannot be used in combination with CMC start kit
NA	CMH-36	W42HC, W48HC, W60HC	Outdoor Thermostat Kit used to disable compressor cooling below 50°F outdoor temp. Adjustable between 50° and 0°F
NA	CMC-33	W42HC, W48HC, W60HC	Dirty Filter Kit
NA	CMC-35	W42HC, W48HC, W60HC	Alarm Relay Kit

////// 24VAC LOW VOLTAGE TERMINAL DESIGNATIONS

Bard WALL MOUNT products provide 24VAC power to controllers and thermostats. They also are able to receive 24VAC signals from a controlling device. The V controls option provides additional sensors for use with a field supplied DDC controls systems. The information below provides terminal designations and how they are used in the WALL MOUNT unit. More information on low voltage connections and operational sequences is provided in the unit installation manual.

Terminal	Unit	Description
R	All Units	24VAC low voltage output (HOT Terminal)
RT	All Units	RT terminal has jumper to R terminal. When jumper is removed, R and RT can be used with normally closed contacts for fire/smoke detector for unit shutdown.
C	All Units	Ground Terminal
G	All Units	Indoor fan input
Y1	All Units	1st Stage cooling input. Economizer stage when used. Balanced Climate stage when used.
Y2	All Units	2nd Stage cooling input. Compressor cooling stage when Economizer is used.
B/W1	All Units	Reversing Valve (energize for heating)
W2	All Units	1st Stage electric heat
W3	All Units	2nd State electric heat. Jumper between W2 and W3 must be removed for staged heat
A	Vent option units only	Ventilation option input. Calls for occupied vent air intake for CRV, ERV, ECON
D	Dehum. units only	Dehumidification input on units equipped with mechanical reheat dehumidification
L	All Units	24VAC Alarm active output
1	J Control Opt.	Alarm relay Normally Closed Contact
2	J Control Opt.	Alarm relay Normally Open Contact
3	J Control Opt.	Alarm Relay Common Contact
11	F Control Option	Filter Switch, Normally Open Contacts
12	F Control Option	Filter Switch, Normally Open Contacts

OPTIONAL CONTROLS AND KIT COMPONENT DEFINITIONS

Hi Pressure Control (HPC) - The high pressure control provides a means of protecting the refrigeration circuit when high system pressures occur. It is a auto-reset device that is connected to the Compressor Control Module. When activated, the compressor is disabled until pressures reach an acceptable level. If activated twice in the same cooling call, compressor operation is locked out until the cooling call is interrupted.

Low Pressure Control (LPC) - The low pressure control provides a means of protecting the refrigeration circuit when extremely low system pressures occur. It is a auto-reset device that is connected to the Compressor Control Module. When activated, the compressor is disabled until pressures reach an acceptable level.

Heat Pump Control Board (HCB) - The heat pump control module locks out compressor operation to protect the refrigeration system based on signals from the hi and low pressure switches. It provides diagnostics to indicate when a refrigerant pressure event occurs through a LED light. Defrost operation is controlled by the board, and defrost timing is adjustable. A 10k defrost sensor is connected to the condenser coil to sense coil freeze conditions. The Control board energizes a 3-way reversing valve to activate compressor heating operation when the "B" 24VAC terminal is energized on the low voltage terminal block.

Alarm Relay (ALR) - The alarm relay provides a set of NO and NC pilot duty contacts that operate when the heat pump control board locks out compressor operation because of a high or low system refrigerant pressure event.

Low Ambient Control (LAC) - The low ambient control pressure sensor is attached to the suction line of the system, and monitors low side system pressure. Operation of the LAC occurs as outdoor temperatures drop below the 65°F. On/Off and modulating controls are used. On/Off LAC operation cycles the condenser fan operation based on outdoor temperature. Modulating LAC operation is factory adjusted and slows the condenser fan speed RPM based on outdoor temperature.

Crankcase Heater (CCH) - The heater is a belly band that is installed around the base of the compressor that applies heat when the refrigeration system is not operational. This heat is meant to prevent refrigerant oil migration when the unit is not running. Normal scroll compressor use does not require the use of the CCH, and this option is only recommended for northern areas of the US and Canada with extreme cold operation. Field Install Option Only.

Outdoor Thermostat (ODT) - The outdoor thermostat measures outdoor temperatures and includes relay contacts (NO). The relay is located on the outer control panel and the sensor bulb is mounted to the fan shroud in the outdoor condenser section. When wired into the cooling signal inside the control panel, compressor operation can be disabled when temperatures are below the adjustable setting. Adjustment range is 0°F to 50°F.

PTCR Start Kit - PTCR (Precision Temperature Coefficient Resistor) start kit includes the start device and wires needed for installation. The device is located inside the unit control panel near the compressor capacitor and provides an increase in starting torque. The PTCR Start Kit is not normally required when a clean, stable power source is available for the unit. The kit can only be used in 230 Volt single phase units.

Start Capacitor and Potential Relay Start Kit - The kit includes a start capacitor and relay that is energized during startup of the compressor. The capacitor, relay, and needed wires are provided in a metal enclosure that is field installed in the outdoor section attached to the back. The Start Capacitor Kit is not normally required when a clean, stable power source is available for the unit. The kit can only be used in 230 Volt single phase units. Start capacitor kit cannot be used with the PTCR start kit installed.

Dirty Filter Switch Indicator (DFS) - The switch is adjustable and measures pressure drop across the unit filter surface. When pressure drop is higher than the switch setting NO and NC contacts are provided to indicate the filter needs to be serviced.

Dehumidification Control Board (Dehum models only) - The dehumidification control board operates a refrigerant valve to control dehumidification operation. To energize the valve, 24VAC power is applied to the "D" terminal on the low voltage terminal strip. When the valve is energized, hot compressor discharge refrigerant is used to warm a reheat coil located in the evaporator section. The reheat coil warms the cold air leaving the evaporator coil. The result is moisture removal from the air leaving the supply when no cooling or heating is needed in the area. When a call for cooling or heating occurs, dehumidification operation is disabled.

////// CABINET AND CLEARANCE DIMENSIONS - W**HC SERIES UNITS

CLEARANCES REQUIRED FOR SERVICE ACCESS AND ADEQUATE CONDENSER INLET AIRFLOW

MODELS	LEFT SIDE	RIGHT SIDE
W42HC, W48HC, W60HC	20"	20"

- 1.) Follow all national, state, and local codes and regulations regarding the installation of heating and cooling equipment regarding Single Packaged Vertical Units (SPVU) including electrical access clearances.
- 2.) Field ventilation installation with the unit installed requires 40" on the left or right side of the unit.
- 3.) Bard recommends a minimum of 10 ft. between the unit front condenser air outlet and solid objects including fences, walls, bushes, and other airflow obstructions.
- 4.) Bard recommends a minimum of 15 ft. between the condenser air outlets of 2 units that are facing each other.
- 5.) Bard recommends a minimum clearance of 4" under the unit cabinet for condenser defrost drain age during heat pump operation.

MINIMUM CLEARANCES REQUIRED TO COMBUSTIBLE MATERIALS

MODELS ①	SUPPLY AIR DUCT FIRST THREE FEET	CABINET
W42HC, W48HC, W60HC	1/4"	0"

① Refer to the Installation Manual for more detailed information.

DIMENSIONS OF W42HC-W60HC BASIC UNIT FOR ARCHITECTURAL & INSTALLATION REQUIREMENTS (NOMINAL)

MODEL	WIDTH (W)	DEPTH (D)	HEIGHT (H)	SUPPLY		RETURN															
				A	B	C	B	D	E	F	G	I	J	K	L	M	N	O	R	S	T
W42HC W48HC	42	25.52	84.88	9.88	29.88	15.88	29.88	25.52	43.88	12.63	39.06	30.06	53.75	26.94	55.59	52.59	8.82	43	1.438	16	1.88
W60HC	42	25.52	93.0	9.88	29.88	15.88	29.88	25.52	43.88	12.63	45	30.06	59.75	35.06	61.72	58.72	8.82	43	1.438	16	10.00

① Wall Mounting holes in side flanges are 0.375.

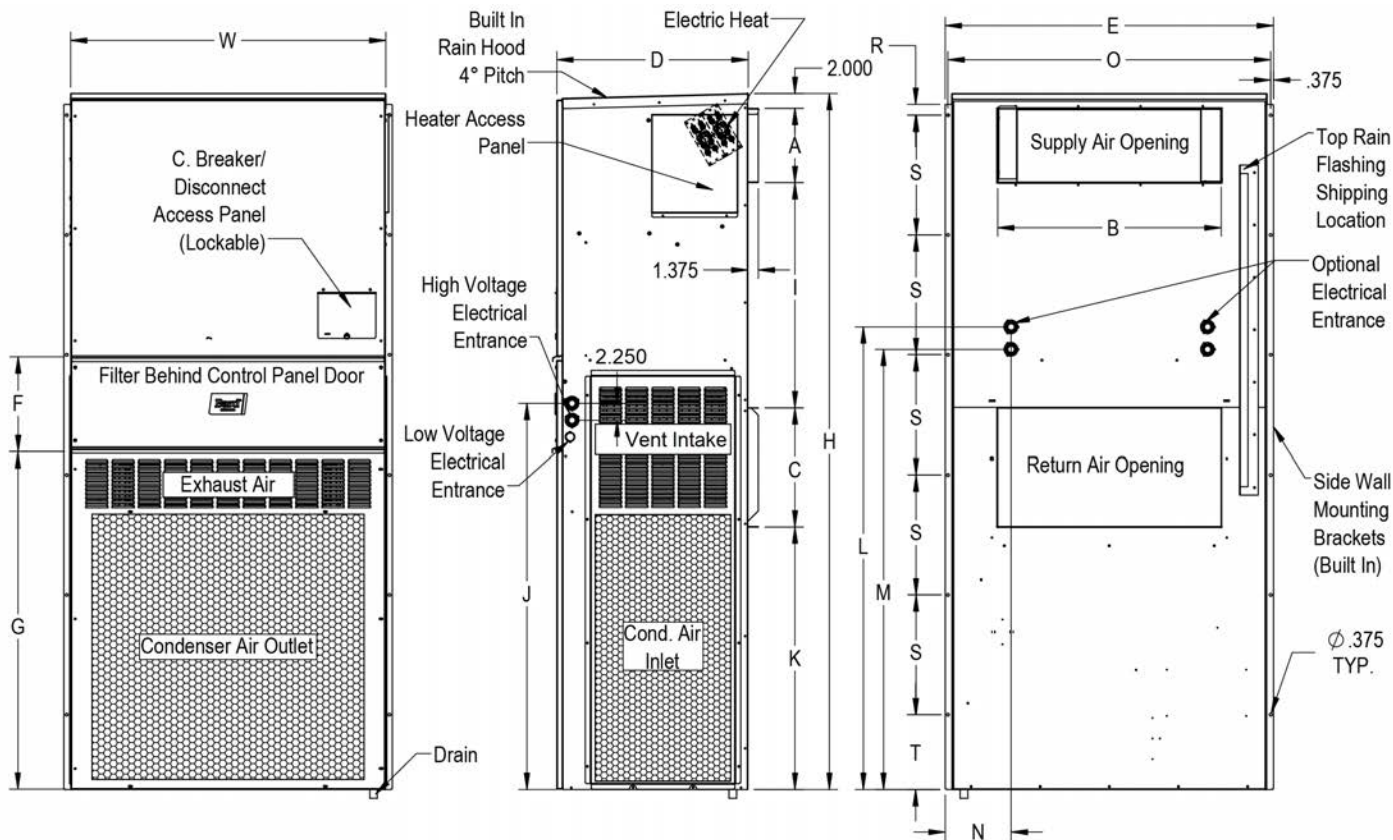

MIS-3978

////// WALL CURB ACCESSORIES

Optional wall curb accessories are available to help reduce vibration through the outer wall surface or to use existing wall openings when replacing equipment. Follow all static pressure airflow requirements, safety and installation guidelines in the instructions provided with the curb and WALL MOUNT products.

CURB	UNITS USING CURB	DESCRIPTION
WMICF5 *	W42HC, W48HC, W60HC	Provides vibration isolation for reduced sound transmission through wall
WWC5 *	W42HC, W48HC, W60HC	Install to use with existing wall openings. Wall openings must provide sufficient airflow

* Color Option

////// INDOOR SOUND REDUCTION ACCESSORIES

Optional sound accessories are available to help reduce sound transmission from the supply and return openings inside the indoor area. Follow all static pressure airflow requirements, safety and installation guidelines in the instructions provided with the accessories and WALL MOUNT products.

ACCESSORY	UNITS USING ACCESS.	DESCRIPTION
WAPR11 *	W42HC, W48HC, W60HC	Acoustical return air plenum that offsets the return air path. Air intake at floor level

* Color Option

////// NON-DUCTED SUPPLY AND RETURN GRILLES

Supply and return louver grilles are of a brushed aluminum finish. 2" flange versions are recommended for standard installations to allow grille attachment when large wall openings are present. Return filter grilles are available for filter access from an indoor area. Filter grilles do not include a filter, and are not recommended for unit with ventilation due to filter location. A manual damper return grille is available for W30 and W36 models. The manual damper is adjustable, and is only recommended for installations where increased return duct static pressure is required.

GRILLE NO.	UNITS USING GRILLE	DESCRIPTION OF LOUVER GRILLE
SG-5W	W42HC, W48HC, W60HC	10" x 30" with 2" Flange 4 way deflection supply grille. Use for standard installations
RG-5W	W42HC, W48HC, W60HC	16" x 30" with 2" Flange return grille. Use for standard installations.
RFG-5W	W42HC, W48HC, W60HC	16" x 30" with 2" Flange return grille with filter bracket.
RGD-5	W42HC, W48HC, W60HC	16" x 30" with 1" Flange return grille. Manual damper used to restrict return air

////// NON-DUCTED SUPPLY GRILLES - SPREAD AND THROW CHARACTERISTICS

One of the most important setup procedures for non-ducted supply applications is to adjust the 4 way supply grille blade positions. Placement of equipment, occupants, the thermostat, and room size can all play an important role in deciding how the conditioned supply air must be directed in an indoor area. The chart below may be used as a reference tool to help with this process.

SUPPLY GRILLE	AIRFLOW CFM	DEFLECTION	VELOCITY	TOTAL PRESSURE	THROW
SG-5W	1450 CFM	0°	968	.073" WC	51-73 ft.
		22.5°	1071	.103" WC	39-56 ft.
		45°	1331	.169" WC	28-40 ft.
	2000 CFM	0°	1336	.130" WC	61-86 ft.
		22.5°	1477	.188" WC	54-65 ft.
		45°	1835	.335" WC	33-46 ft.

////// CONTROLLER, THERMOSTAT, HUMIDISTAT AND CO2 VENTILATION CONTROL OPTIONS

Bard provides a wide variety of controllers for equipment cooling, thermostats, for equipment and comfort cooling, humidistats for dehumidification units, and CO2 sensors for ventilation control. Lockable thermostat covers are available for applications where security or supervisory control is desired.

CONTROLLER	OPERATION	DESCRIPTION
MC-4002	2 Unit Lead/Lag Controller	Standard Lead/Lag Controller with remote alarming capability.

THERMOSTAT	OPERATION	DESCRIPTION
8403-060	3 Heat/3 Cool	Programmable or Nonprogrammable, ventilation output, dehumidification operation
8403-089	1 Heat/1 Cool	Temp. Settings per Day 4, 2, 1, 0 Programs per Week 7, 5-2, 5-1-1 or Nonprogrammable
8403-090	2 Heat/2 Cool	Temp. Settings per Day 4, 2, 1, 0 Programs per Week 7, 5-2, 5-1-1 or Nonprogrammable
8403-091	1 Heat/1 Cool	Easy to use, Nonprogrammable. FEMA use
8403-092	2 Heat/2 Cool	Programmable or Nonprogrammable, ventilation output, Wi-Fi

HUMIDISTAT	OPERATION	DESCRIPTION
8403-038	Humidity %RH	Easy to use w/SPDT switching. Ratings: Pilot duty 50VA @24V, 120VA @ 120/240V
8403-047	Humidity %RH	Electronic with display, EEPROM memory, lockable keypad, humidity sensor calibration

CO2 CONTROL	OPERATION	DESCRIPTION
S8403-067	CO2 PPM	CO2 ventilation control with digital display. On/Off or modulating ventilation operation

THERMOSTAT COVER*	SIZE	DESCRIPTION
8405-003	(Inside) 5-1/16" H x 6-1/16" W (Outside) 6-1/2" H x 7-1/2" W x 2-15/16" D	Clear acrylic with ventilation. Fits all thermostats except 8403-060
8405-005	(Inside) 5-7/8" H x 8-3/8" W (Outside) 7-1/4" H x 9-3/4" W x 3-3/8" D	Clear acrylic with ventilation. Fits all thermostats.
8405-006	(Inside) 5-1/16" H x 6-1/16" W (Outside) 6-3/8" H x 7-3/8" W x 2-7/8" D	Metal with ventilation. Fits all thermostats except 8403-060
8405-007	(Inside) 5-7/8" H x 8-3/8" W (Outside) 7-1/8" H x 9-5/8" W x 3-1/4" D	Beige painted steel cover with ventilation. Fits all thermostats.

* Thermostat covers include ventilation, but may effect temperature control reaction time. If security control lockout is needed, the 8403-060 thermostat provides input control lockout features.



Bard Manufacturing Company, Inc.
1914 Randolph Dr., Bryan, OH 43506
419-636-1194
www.bardhvac.com

Due to our continuous product improvement policy, all specifications subject to change without notice.