

Contents - Residential

Model Nomenclature	TOC-6
Connected Home Solutions	
• Conventional 24 Volt Connected Controls.....	CHS-1
• AccuLink™ Communicating Connected Controls	CHS-2
• Nexia™ Bridges & Starter Bundles	CHS-3
• Nexia™ Compatible Products	CHS-4
Split System Cooling	
• AccuComfort™ Variable Speed Single Phase, 2-5 Tons (4A7V0, 4A7V8)	SC-1
• Single Phase, 1½-5 Tons (4A7A7, 4A7A6, 4A7L6).....	SC-3
• Single Phase, 1½-5 Tons (4A7A4, 4A7A3)	SC-5
• Three Phase (4A7C7, 4A7C4, 4A7C3, 4A7S6)	SC-7
Split System Heat Pumps	
• Summary of System Ratings	SH-1
• AccuComfort™ Variable Speed Single Phase, 2-5 Tons (4A6V0, 4A6L9, 4A6V8).....	SH-3
• Single Phase, 1½-5 Tons (4A6H7, 4A6H6, 4A6L6)	SH-5
• Single Phase, 1½-5 Tons (4A6H5, 4A6H4).....	SH-7
• Three Phase (4A6C7, 4A6C4, 4A6S6)	SH-9
Air Handlers/Heaters	
• Multi-position Chart.....	AH-1
• Features and Benefits	AH-2
• Series 9 Variable Speed Multi-Position, 2-5 Tons (TAM9)	AH-3
• Series 4 Multi-Position, Single Phase, 1½-5 Tons (TAM4)	AH-5
• Series 5 Multi-Position, Single Phase, 1½-5 Tons (GAM5)	AH-7
• Series 2 Split System, Single Phase, 1½-3 Tons (GAF2)	AH-9
• Heaters for Multi-Position Air Handlers	AH-11
• TEM Split System, Single Phase, 1½-5 Tons (TEM8, TEM6, TEM4).....	AH-13
• Heaters for TEM.....	AH-15
• TMM Wall, Stud, or Over the Water Heater, Single Phase, 1½-3 Tons (TMM5, TMM4)	AH-17
• GMU/GMV Wall, Stud, or Over the Water Heater, Single Phase, 1½-3 Tons (GMU, GMV)	AH-19
• P-Series Modular Blower - Variable Speed.....	AH-21
Coils	
• Split System Aluminum Cased Heat Pump and Cooling (4TXC-DS, 4PXC-U, 4PXC-D)	COIL-1
• Split System Aluminum Uncased Heat Pump and Cooling (4PXA-U)	COIL-2
• Split System Aluminum Cased Heat Pump and Cooling (4TXF, 4MXC, 4GXC)	COIL-3

.....

This publication is for general reference information only and is not intended for systems equipment / combination selections.

Products listed in this book are not always carried in factory/distributor inventory, nor are all products available through all distribution channels. Consult your Distributor for availability and shipping information.

Since American Standard Heating & Air Conditioning has a policy of continuous product improvement, it reserves the right to change design and specification without notice.

.....

Contents - Residential

Furnaces

- S9V2 Two Stage Variable Speed ECM FUR-1
- S9X2 Two Stage High Efficiency ECM..... FUR-2
- S9X1, S9B1 Single Stage High Efficiency ECM FUR-4
- Platinum 95, Silver 95, Silver 95h & American Standard 92
Airflow Directions FUR-6
- Platinum 95 Modulating Communicating Variable Speed (AUHM, ADHM)..... FUR-7
- Special Use Furnace Accessories FUR-10
- S8X2 Two Stage ECM..... FUR-11
- S8X1 Single Stage ECM..... FUR-11
- S8B1 Single Stage ECM..... FUR-12
- Platinum 80, Gold 80v, Gold 80, Silver 80h, Silver 80 & American Standard 80
Airflow Directions FUR-14
- Platinum 80 Two Stage Variable Speed (AUD2-ACV, ADD2-ACV) FUR-15
- Gold 80v Two Stage Variable Speed (AUD-A-V-V, ADD-A-V-V)..... FUR-15
- High Efficiency Oil Furnaces Ordering Information..... FUR-18
- L8X1 - Single Stage, Ultra-Low NOx Gas Furnace..... FUR-19

Indoor Air Quality

- EnviroWise™ CleanEffects™ Whole Home Air Cleaner (EFD)IAQ-1
- Perfect Fit™ Filter Accessories and SlimFit Filters.....IAQ-2
- QuikBox™ Media Cabinet and Filters (TFM).....IAQ-3
- EnviroWise™ CleanEffects™ Dimensions.....IAQ-4
- Humidifiers Steam (EHUMD8)IAQ-6
- Humidifiers Fan Powered and Bypass (EHUMD5).....IAQ-7
- EnviroWise™ Inline Ventilators (QF130V, QF70V)IAQ-10
- EnviroWise™ Whole Home Dehumidifiers with optional Ventilation.....IAQ-11
- Energy Recovery Ventilator (ERV)IAQ-12

Comfort Controls/Zone Sensors

- Conventional 24 Volt Connected Controls..... CCZS-1
- AccuLink™ Communicating Connected Controls CCZS-3
- Zoning Communicating Sensor with Display..... CCZS-6
- Conventional 24 Volt HVAC System Interface Relay Panel for
AccuLink™ Controls CCZS-7
- AccuLink™ Platinum 1050 Control Component Overview..... CCZS-8
- AccuLink™ Zoning Assembly & Zone Expander Panel CCZS-9
- AccuLink™ Zoning Component Overview CCZS-10
- 24 Volt Modulating Dampers CCZS-12
- Programmable Touchscreen Thermostats CCZS-17
- Programmable Thermostats..... CCZS-18
- Programmable 7 Day Comfort Controls CCZS-19
- Non-Programmable Comfort Controls CCZS-19
- Non-Programmable Thermostats..... CCZS-20
- Remote Sensors CCZS-21
- Outdoor Thermostat Kit..... CCZS-22

Contents - Residential

Packaged Units

- Cooling Convertible, 2-5 Tons (4TCY5, 4TCY4, 4TCC4) PK-1
- Hybrid/Dual Fuel Convertible, 2-5 Tons (4DCZ6, 4DCY4) PK-4
- Heating Convertible, 2-5 Tons (4WCZ6, 4WCY5, 4WCC4, 4WCY4) PK-7
- Heating Over/Under 2-3.5 Tons (4WHC4) PK-10
- Gas/Electric Convertible, 2-5 Tons (4YCZ6, 4YCY5, 4YCY4) PK-11
- Gas/Electric Convertible, 2-5 Tons (4YCC4) PK-12
- Convertible, 2-5 Tons Single Power Entry Kits PK-15
- Convertible, 2-5 Tons Supplemental Heaters PK-16

Accessories/Information

- Roof Curbs (BAYCURB050A, BAYCURB051A) AC/IN-1
- Thermal Expansion Valves AC/IN-2
- Equipment Date Identification AC/IN-4
- Refrigerant Line Sets AC/IN-5
- Refrigerant HFC 410A (R-410A) AC/IN-6
- Refrigerant Piping Information for Two Stage Split Systems AC/IN-7
- Split systems with Variable Speed Compressor AC/IN-8
- Branch Circuit Wire Sizing Table/Heater De-Rating Chart AC/IN-9
- Basic Air Conditioning Formulas AC/IN-10
- Low Ambient Accessories, Cooling & Heating Models AC/IN-11
- Wind Shields AC/IN-12

Contents - Light Commercial

Model Nomenclature	TOC-14
Split System Cooling	
• Three Phase, 6-25 Tons, R-410A (TTA)	LSC-1
• Three Phase, 6-25 Tons, R-22 (TTA)	LSC-3
• ReliaTel™ Controls, 6-25 Tons - Protection/Operation Timings and Features.....	LSC-6
Split System Heat Pumps	
• Three Phase, 6-20 Tons, R-410A (TWA)	LSH-1
• Three Phase, 7.5-20 Tons, R-22 (TWA).....	LSH-2
• ReliaTel™ Controls, 6-20 Tons - Protection/Operation Timings and Features.....	LSH-5
Air Handlers/Heaters	
• Single Phase 5-10 Tons (TWE).....	LAH-1
• Three Phase 5-25 Tons (TWE)	LAH-1
Comfort Controls/Zone Sensors	
• Non-Programmable for ReliaTel™ Units.....	LCCZS-1
• Programmable for ReliaTel™ Units	LCCZS-1
• Zone Sensor Unit Installation.....	LCCZS-3
• Micro Control Zone Sensors	LCCZS-4
• Electronic Programmable Zone Sensors for ReliaTel™ Units	LCCZS-5
• Integrated Comfort™ Systems Sensors for ReliaTel™ Units.....	LCCZS-5
Packaged Cooling	
• Convertible, 3-10 Tons Features	LPC-1
• Convertible, 3-5 Tons, R-410A (THC, TSC)	LPC-2
• Convertible, 6-10 Tons, R-410A (THC, TSC)	LPC-3
• Convertible, 3-10 Tons Model Digit Numbers.....	LPC-4
• Convertible, 3-10 Tons Zone Sensors/Thermostats.....	LPC-11
• ReliaTel™ Controls (Packaged Unit Protection/Operation Timings & Features) ...	LPC-12
• ReliaTel™ Controls (Operation with an Electromechanical Thermostat)	LPC-13
• Packaged Cooling with ReliaTel™ Controls, 12½-25 Tons, R-410A (T*D-G/T*H-G)	LPC-14
• Packaged Cooling with ReliaTel™ Controls, 12½-25 Tons Model Digit Numbers	LPC-15
• Packaged Cooling with ReliaTel™ Controls, 12½-25 Tons Zone Sensors/Thermostats.....	LPC-16
• Foundation™ Packaged Cooling, 3-5 Tons, R-410A (GBC)	LPC-21
• Foundation™ Packaged Cooling, 15-25 Tons, R-410A (EBC).....	LPC-24
Packaged Heat Pump	
• Convertible, 3-10 Tons Features	LPH-1
• Convertible, 3-10 Tons (WHC/DHC).....	LPH-2
• Convertible, 3-10 Tons (WSC).....	LPH-4
• Convertible, 3-10 Tons Model Digit Numbers.....	LPH-5
• Packaged Heat Pump with ReliaTel™ Controls, 12½-20 Tons (WSD/WSH).....	LPH-11
• Packaged Heat Pump with ReliaTel™ Controls, 12½-25 Tons Model Digit Numbers ...	LPH-12
• Packaged Heat Pump with ReliaTel™ Controls, 12½-20 Tons Zone Sensors.....	LPH-13

Contents - Light Commercial

Packaged Gas/Electric

- Convertible, 3-10 Tons FeaturesLPG-1
- Convertible, 3-5 Tons, 17 SEER, R-410A (YHC-E).....LPG-2
- Convertible, 3-5 Tons, 15 SEER, R-410A (YHC)LPG-3
- Convertible, 3-5 Tons, 14 SEER, R-410A (YSC-G).....LPG-4
- Convertible, 6-10 Tons, R-410A (YHC-F).....LPG-5
- Convertible, 6-10 Tons, R-410A (YSC)LPG-6
- Convertible, 3-10 Tons Model Digit Numbers.....LPG-7
- Convertible, 3-10 Tons Zone Sensors/Thermostats.....LPG-11
- Packaged Gas/Electric with ReliaTel™ Controls 12½-25 Tons,
R-410A (YHD-G, YHH-G)LPG-12
- Packaged Gas/Electric with ReliaTel™ Controls 12½-25 Tons,
R-410A (YSD-F, YSH-F).....LPG-13
- Packaged Gas/Electric with ReliaTel™ Controls 12½-25 Tons
Model Digit NumbersLPG-14
- Packaged Gas/Electric with ReliaTel™ Controls 12½-25 Tons
Zone Sensors/ThermostatsLPG-16
- Foundation™ Packaged Gas/Electric, 3-5 Tons, R-410A (GBC).....LPG-18
- Foundation™ Packaged Gas/Electric, 15-25 Tons, R-410A (GBC/GBD)LPG-20

Accessories/Information

- 3-25 Ton Packaged Units Roof Curb Compatibility Information LAC/IN-1
- 6-20 Tons Split System LAC/IN-2

BUILT TO A HIGHER STANDARD

American Standard
HEATING & AIR CONDITIONING

Model Nomenclature Residential

Outdoor Units

1 2 3 4 5 6 7 8 9 10 11 12 13 14 15
4 A 6 V 0 0 3 6 A 1 0 0 0 A A

- Refrigerant Type
2 = R-22
4 = R-410A
- A, T = American Standard
- Product Type
6, W = Split Heat Pump
7, T = Split Cooling
- Product Family
V = Variable Speed
Z = Leadership - Two Stage
X = Leadership
R = Replacement/Retail
- M or B = Basic
A = Light Commercial
C = Commercial
L = Side Discharge 1-Phase
S = Side Discharge 3-Phase
- Family SEER
3 = 13 6 = 16 0 = 20
4 = 14 7 = 17
5 = 15 8 = 18
 9 = 19
- Split System Connections 1-6 Tons
0 = Brazed
- Nominal Capacity in 1000s of BTUs
- Major Design Modifications
- Power Supply
1 = 200-230/1/60 or 208-230/1/60
3 = 200-230/3/60
4 = 460/3/60
- Secondary Function
- Minor Design Modifications
- Unit Parts Identifier

ForeFront Air Handler

1 2 3 4 5 6 7 8 9 10 11 12 13 14 15
G A M 2 A 0 A 3 6 S 3 1 S A A

- Brand
T = American Standard
G = Good (American Standard Branded)
- Product Type
A = Air Handler
E = Air Handler
- Convertability
M = Multi-poise 4-way
F = Upflow Front Return, 3-way
T = 3-way
- Product Tier
2 = Good, Entry Level Feature Set
4 = Better, Retail Replacement Mid Effy.
5 = Better, Entry Level High Effy., Multi-Speed
7 = Best, Retail Replacement High Effy., Variable-Speed
8 = Best, Retail Ultimate High Effy., Variable-Speed
9 = Best, Comm/24V Variable-Speed
G = Best, Geothermal
- Major Design Change
- No Descriptor
0 = Air Handler / Coil
- Size (Footprint)
A = 17.5 x 21.8
B = 21.3 x 21.8
C = 23.5 x 21.8
- Cooling Size: Air Handler or Coil
0-9 = AH Coil - 1000 BTU's (18, 24, 30, 36, 42, 48, 60)
- Airflow Type & Capability
S = Standard Effy PSC, 1-5 - nom. Tonnage (cfm/ton)
M = Mid Effy Multi-Speed, 1-5 - nom. Tonnage (cfm/ton)
H = High Effy Variable, 1-5 - nom. Tonnage (cfm/ton)
V = High Effy Variable, 1-5 - nom. Tonnage (cfm/ton)
- Power Supply
1 = 208-230/1/60
- System Control Type
S = Standard - 24 VAC
C = CLII 13.8 VDC
D = Dual (24 VAC / CLII 13.8 VDC) and Epoxy Coated Coil Fins
E = Epoxy Coated Coil Fins
- Minor Design Change
- Service Digit - Not Orderable

Accessories

1 2 3 4 5 6 7 8 9 10 11
A Y E C O N 0 0 1 A A

- Denotes: Accessories**
- Accessories Type** (Example: BAYCURB, AY, ASY)
- | | |
|---|--|
| ASCT = Anti-Cycle Timer | LOAM = Low Ambient Controls |
| BARM = Barometric Relief | LPKT = L.P. Kit |
| BASE = Subbase | LSDR = Low Static Drive |
| BRZQ = Coupling Kit Adaptors | NXKT = NOx Rod Accessory Kit |
| CCHT = Crankcase Heater | PANL = Panel |
| CLE = Coil Enclosures | PLNM = Plenum |
| CURB = Roof Curb | PLUS = Add-on Heat Pump |
| DMPR = Damper | REFLN = Refrigerant Lines |
| DNFLW = Downflow Conversion Kit | RLAY = Relay |
| ECMT = Extreme Mounting Kit | SEAC = Sea Coast Kit |
| ECON = Economizer | SENS = Sensor |
| ENTH = Enthalpy Control | SPEK = Single Power Entry Kit |
| FLTR = Filter | STAT = Thermostat |
| GARD = Coil Guard | TBKT = Thru Base Utility Kit |
| GRLE = Return Air Grill | TEST = Test Accessory |
| HALT = High Altitude Kit | TFMR = Transformer |
| HGBP = Hot Gas Bypass Control | TWIN = Twinning Kits |
| HSMT = High Static Motor | TXVA = Cooling —
Bleed/Non Bleed Kits |
| HTRA = Electric Heater
(Digit 7 Is Used To
Differentiate The
Products Accessory
Is Used With) | TXVH = Heat Pump
Non Bleed Kits |
| ISLT = Isolator | UTIL = Curb Ext. Kit |
| KSKT = Start Accessory Kit | VENT = Termination Kit |
| LEGS = Snow Legs | WAR = Warranty |
| LEGSCAP = Leveling Caps | WATR = Hydronic Heat Coils |
| LIFT = Lifting Lug Kit | WRKT = Wire Kit |
| | 2STG = 2 Stage Gas |
- Major Design Change**
Numbers Are Sequentially Assigned Except For Electric Heaters.
On Electric Heaters Digit 8 Is Used To Identify Voltage And Digit 9
And 10 Are Used To Identify Capacity In KW's.
 - Minor Design Change**
Accessory To Unit Match-up (When Required)
 - Service Digit - Not Orderable**

ForeFront Air Handler Electric Heaters

1 2 3 4 5 6 7 8 9 10 11 12 13 14 15
B A Y E A A C 1 5 B K 1 A A A

- Brand
B = Both Brands
- Product Type
AY = Accessory
- Heat Type
E = Electric Heater
- Product Tier
A = TAM9, TAM4, GAM5, TAMGB
E = TAM8, TAM7
C = GAF2
- Size (Footprint)
A-C = Minimum Cabiner Width
- Size (Footprint)
A-C = Maximum Cabiner Width
- Electric Heat Input
Electric Heat KW
- Connection
BK = Breaker
LG = Lugs
- Power Supply
1 = 208-230/1/60
A = 200/1/50
3 = 208-230/3/60
- Major Design Modification
- Minor Design Modification
- Service Digit - Not Orderable

For complete equipment / combination selections, installation instructions and warranty information, please refer to Product Data/Ratings and/or Installers Guides and Limited Warranty Handbooks.

Model Nomenclature Residential

Air Handler - Residential

1 2 3 4 5 6 7 8 9 10 11 12 13 14 15
T E M 4 A 0 B 3 6 S 3 1 S A A

Brand
T = American Standard

Product Type
E = Metal Cabinet
M = Metal Over Hot Water Heater

Convertability
M = Multi-poise 4-way

Product Tier
3 = Entry Level Multi-Speed
4 = Entry Level Multi-Speed
5 = Entry Level High Efficiency
6 = Entry Level Variable Speed
8 = Entry Level Comm/24V Variable Speed

Major Design Change

No Descriptor
0 = Air Handler / Coil

Size (Footprint) (W x D)
A = 20.5 x 15.0
B = 18.5 x 21.1 (TEM), 22.0 x 19.0 (TMM)
C = 23.5 x 21.1
D = 26.5 x 21.1

Cooling Size: Air Handler or Coil
0-9 = AH Coil - 1000 BTU's (18, 24, 30, 36, 42, 48, 60)

Airflow Type & Capability
S = Standard Effy, 1-5 - nom. Tonnage (cfm/ton)
M = Mid Effy Multi-Speed, 1-5 - nom. Tonnage (cfm/ton)
H = High Effy Variable, 1-5 - nom. Tonnage (cfm/ton)
V = High Effy Variable, 1-5 - nom. Tonnage (cfm/ton)

Power Supply
1 = 208-230/1/60

System Control Type
S = Standard - 24 VAC
C = CLII 13.8 VDC
D = Dual (24 VAC / CLII 13.8 VDC)

Minor Design Change

Service Digit - Not Orderable

Air Handler/ Electric Furnace Heaters

1 2 3 4 5 6 7 8 9 10 11 12 13 14
B A Y H T R 1 4 1 5 B R K A

Accessory

Heater

Power Supply
1 = Single Phase
3 = Three Phase

Series/Family
3 = 2/4TEH Models Only
4 = 4TEC / Legacy
5 = TEM Models Only

Heater KW

Electrical Connection
000 = Pig Tails Only
BRK = Circuit Breaker
PDC = Pull Disconnect
RBR = Recessed Breaker-TVF018, TVF024, 14" Deep only
RPD = Recessed Pull Disconnect-TVF018, TVF024, 14" Deep only

Minor Design Change

Air Handler

1 2 3 4 5 6 7 8 9 10 11 12 13 14 15
4 F W C A 0 2 4 A 1 0 0 0 A A

Refrigerant Type
4 = R-410A

Model Type
FWC = Convertble
FWH = Convertible with Constant Torque ECM Motor
FWM = Stud Mount with Factory Installed Electric Heat
FWD = Furr-Down Uncased with Factory Installed Electric Heat
FWF = Furr-Down Cased with Factory Installed Electric Heat

Insulation
A = Standard
F = R4.2 Insulation

Capacity
Nominal Capacity in 1000's (BTUH)

Major Design Change

Power Supply
1 = Single Phase

Electrical Connection
0 = Pig Tails
D = Pull Disconnect

Electric Heater
00 = No heater
05 = 5 KW
08 = 8 KW
10 = 10 KW
15 = 15 KW
20 = 20 KW

Minor Design Change

Service Digit - Not Orderable

Model Nomenclature Residential

Gas Furnaces

1 2 3 4 5 6 7 8 9 10 11 12 13 14 15
A U D 1 B 0 8 0 A 9 H 3 1 A A

- Furnace Configuration**
AU = Upflow/Horizontal
AD = Downflow/Horizontal
- Type**
E = 80% Induced Draft Standard
D = 80% Induced Draft Premium
C = 90% Condensing Standard
X = 90% Condensing Premium
H = 95% Condensing Premium
- Number of Heating Stages**
1 = Single Stage
2 = Two Stage
3 = Three Stage
M = Modulating
- Cabinet Width**
A = 14.5" Cabinet Width
B = 17.5" Cabinet Width
C = 21.0" Cabinet Width
D = 24.5" Cabinet Width
- Heating Input in 1000's (BTUH)**
080 = 80,000 BTUH
- Major Design Change**
- Voltage**
9 = 115 Volts / 60 Hertz / Natural Gas
A = 115 Volts / 50 Hertz / Natural Gas
C = 115 Volts / Natural Gas with Communicating System Control
F = 115 Volts / Natural Gas with Integrated Electronic Filter
D = 115 Volts / Natural Gas with Communicating System Control and Integrated Electronic Filter
- Air Capacity for Cooling**
Standard PSC Variable Speed High Efficiency
24 = 2 Tons V3 = 3 Tons H3 = 3 Tons
36 = 3 Tons V4 = 4 Tons H4 = 4 Tons
42 = 3.5 Tons V5 = 5 Tons H5 = 5 Tons
45 = 4 Tons
48 = 4 Tons
54 = 5 Tons
60 = 5 Tons
72 = 6 Tons
- Draft Inducer Speeds**
1 = Single Speed
2 = Two Speed
V = Variable Speed
- Minor Design Change**
- Service Digit - Not Orderable**

S-Series Furnaces

1 2 3 4 5 6 7 8 9 10 11 12 13 14 15
S 8 B 1 B 0 8 0 U 2 P S A A A

- Level**
S = Series
- AFUE**
8 = 80%
9 = 90% or Higher
- Blower**
B = Base model PSC
P = PSC
X = CTM
V = Variable Speed
- Gas Valve Stages**
1 = Single Stage
2 = 2 Stage
M = Modulating
- Cabinet Width**
A = 14.5"
B = 17.5"
C = 21"
D = 24.5"
- BTU Input**
080 = 80,000 BTUH
- Poise Options**
U = 3 Way
D = Dedicated Downflow
M = 4 Way Poise
- Air Capacity for Cooling**
(in nominal tons)
2 = 2 Tons
3 = 3 Tons
4 = 4 Tons
5 = 5 Tons
- Inducer Type**
P = PSC
X = CTM
V = Variable Speed
- Communicating Capability**
S = 24 Volt
C = Communicating System Control
- Major Design Change**
- Minor Design Change**
- Service Digit - Not Orderable**

Model Nomenclature Residential

Heat Pump/ Cooling Coils

1 2 3 4 5 6 7 8 9 10 11 12 13 14 15
4 T X C B 0 3 6 A C 3 H C A A

Refrigerant Type
4 = R-410A

Series
T = Premium (Cooling and HP)
N = Premium (Cooling and HP)
P = Premium High Efficiency - Dedicated position (Cooling and HP)
C = Standard (Cooling Only)
F = Entry Level (Cooling Only)
G = Entry Level (Cooling and HP)
M = Entry Level (Cooling and HP)

Coil Design
X = Direct Expansion Evaporator Coil

Coil Feature
C = Cased A Coil
A = Uncased A Coil
F = Cased Horizontal Flat Coil

Coil Width (Cased/Uncased)
A = 14.5" / 13.3"
B = 17.5" / 16.3"
C = 21.0" / 19.8"
D = 24.5" / 23.3"
H = 10.5"

Refrigerant Line Coupling /
Airflow Configuration
0 = Brazed
U = Upflow only, convertible to Horizontal Left
D = Downflow only, convertible to Horizontal Right

Nominal Capacity in 1000's (BTUH) /
Model Number Distinguisher

Major Design Change

Efficiency
C = Standard
S = High Efficiency (derived from 10 SEER products)
Z = High Efficiency (TXV modulates to 50%)

Refrigerant Control
3 = TXV - Non-Bleed
6 = FCCV (Flow Control/Check Valve)

Coil Circuitry
H = Heat Pump
C = Cooling

Airflow Configuration
A = Upflow
U = Upflow /Downflow
D = Downflow
R = Downflow / Horizontal Right
H = Horizontal Left/Right
C = Convertible - Upflow, Downflow, Left or Right

Minor Design Change

Service Digit - Not Orderable

BUILT TO A HIGHER STANDARD™

American Standard
HEATING & AIR CONDITIONING

Model Nomenclature Residential

American Standard AccuClean™ Whole Home Air Cleaner

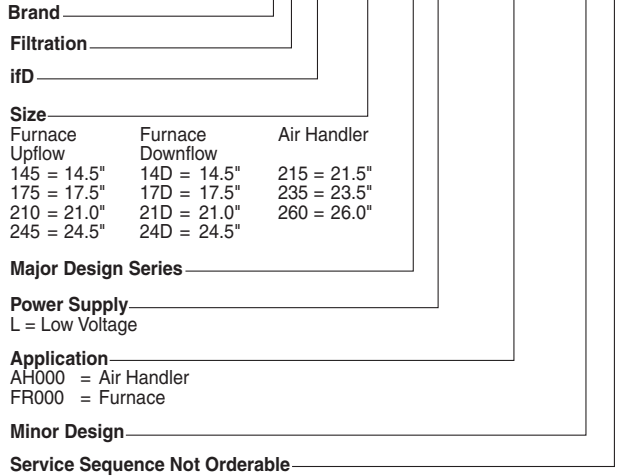

Perfect Fit™ Air Cleaner

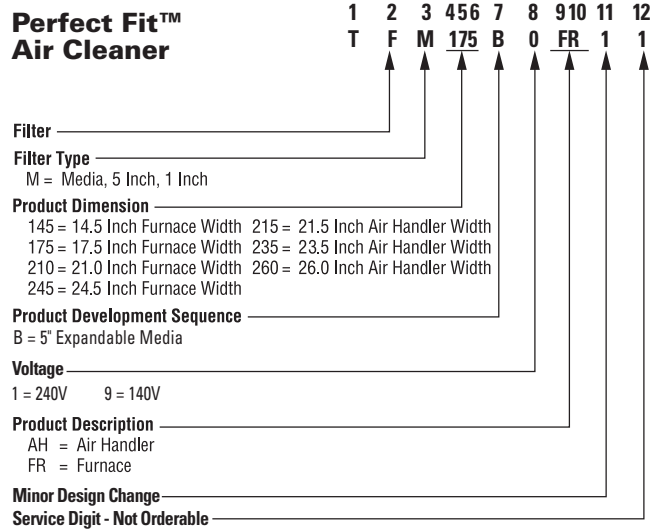

TXV Kits

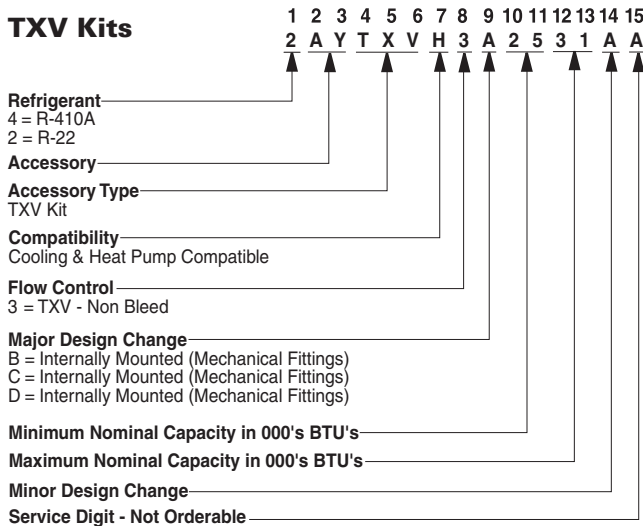

Perfect Fit™ Filter Accessories

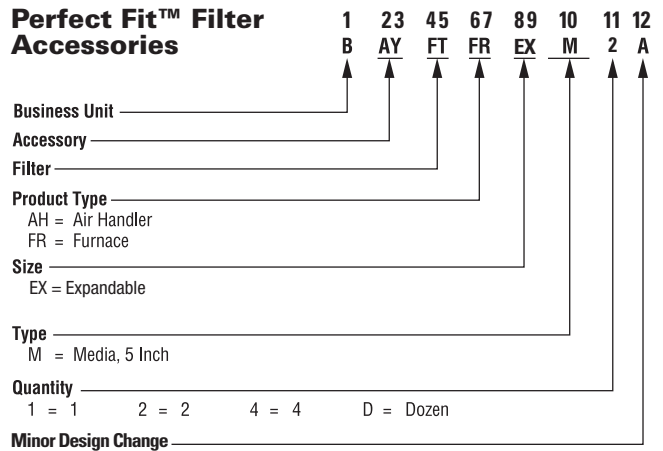

For complete equipment / combination selections, installation instructions and warranty information, please refer to Product Data/Ratings and/or Installers Guides and Limited Warranty Handbooks.

BUILT TO A HIGHER STANDARD

American Standard
HEATING & AIR CONDITIONING

Model Nomenclature Residential

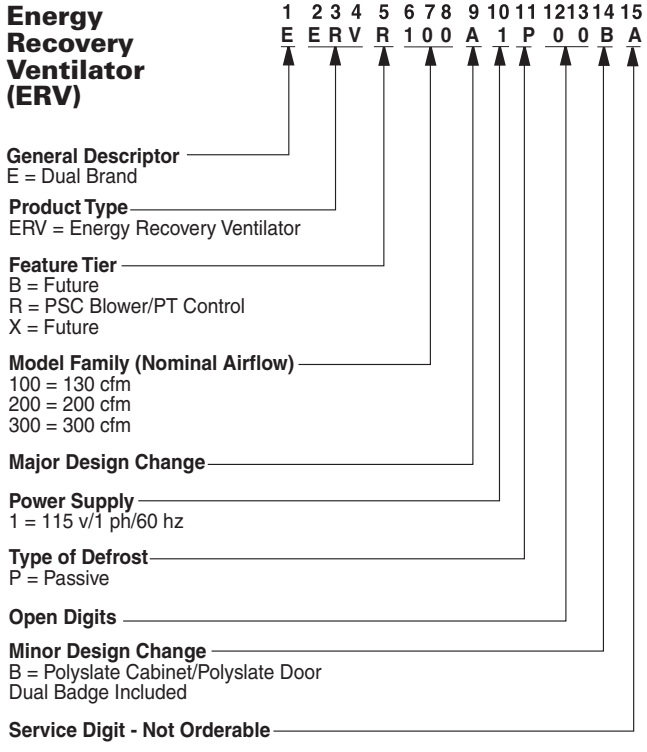
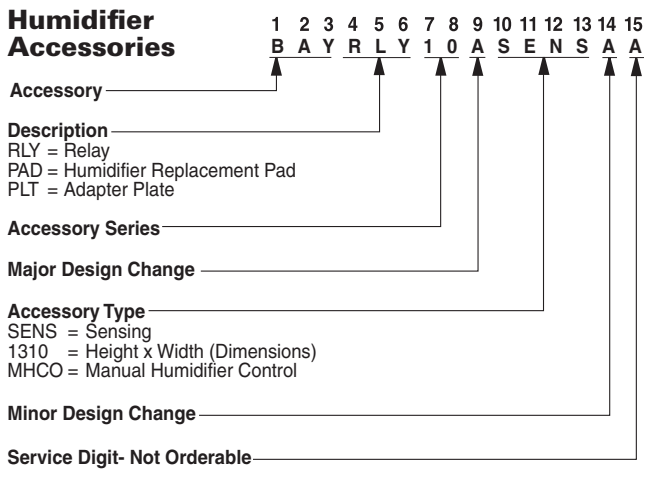
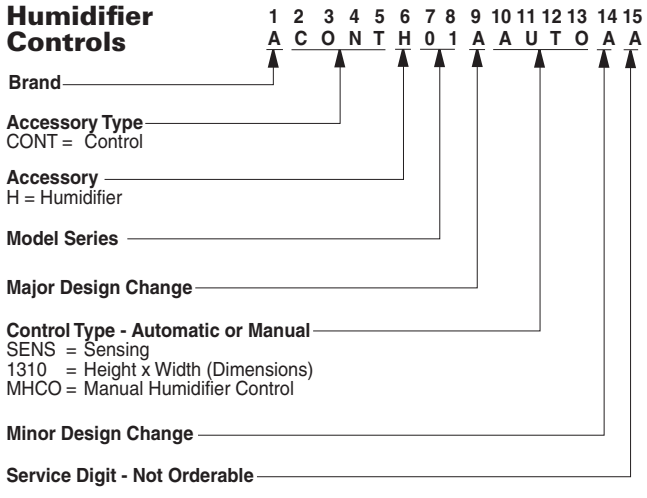
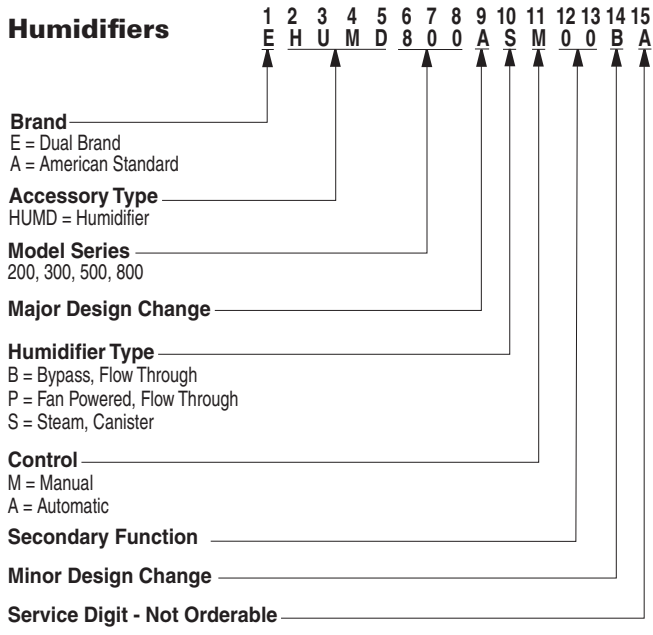

For complete equipment / combination selections, installation instructions and warranty information, please refer to Product Data/Ratings and/or Installers Guides and Limited Warranty Handbooks.

Model Nomenclature Residential

Packaged Units

1 2 3 4 5 6 7 8 9 10 11 12 13 14 15
4 Y C X 3 0 4 2 A 3 0 8 0 A A

- Refrigerant** ————— 4 = R-410A
- Type** —————
Y = Gas Electric
W = Heat Pump
D = Dual Fuel
T = Air Conditioner
- Configuration** —————
C = Convertible
H = Horizontal (only)
- Model Tier** —————
C = Entry Level
X = Upgrade
Y = Premium
Z = Leadership - (2-Stage)
- Efficiency Tier** —————
3 = 13 SEER
4 = 14 SEER
5 = 15 SEER
6 = 16 SEER
- Capacity in 1000's (BTUH)** —————
018 042
024 048
030 060
036
- Major Design Change** —————
- Voltage & Phase** —————
1 = 230V 1 Phase
3 = 230V 3 Phase
4 = 460V 3 Phase
- Gas Heat Input (MBTU/H)** —————
000 (AC or HP) 075
040 096
064 120
- Minor Design Change** —————
- Service Digit - Not Orderable** —————

Packaged Units (Pre-410A Refrigerant)

1 2 3 4 5 6 7 8 9 10 11 12
Y C X 0 3 6 G 1 M 0 A 0

- Product Type** —————
TC = Cooling, Electric Heat
WC = Heat Pump Packaged
YC = Gas Electric
DC = Heat Pump with Gas Heat
- Airflow Configuration** —————
D = Downflow Y = Super High Efficiency
H, K = Horizontal Z = Ultra High Efficiency
C = Convertible
X = High Efficiency
- Cooling Capacity in 1000's (BTUH)** —————
018 = 1 1/2 Tons 060 = 5 Tons
024 = 2 Tons 150 = 12 1/2 Tons
030 = 2 1/2 Tons 180 = 15 Tons
036 = 3 Tons 210 = 17 1/2 Tons
042 = 3 1/2 Tons 240 = 20 Tons
048 = 4 Tons 300 = 25 Tons
- Commercial High Efficiency Units**
151 = 12 1/2 Tons
181 = 15 Tons
211 = 17 1/2 Tons
241 = 20 Tons
301 = 25 Tons
- Major Design Change** —————
F = Impack – Side by Side – Ft. Smith Only
B = Over/Under – Ft. Smith Only
G = Impack Plus – Side by Side – Ft. Smith Only
- Electrical Characteristics** —————
1 = 208-230/1/60
3 = 208-230/3/60
4 = 460/3/60
- Secondary Capacity And/Or Factory-Installed Options** —————
OO = No Heat, No Options
LO = Low Heating Capacity
MO = Medium Heating Capacity
HO = High Heating Capacity
- Minor Design Change** —————
- Service Digit - Not Orderable** —————

Model Nomenclature Residential

Controls

1 2 3 4 5 6 7 8 9 10 11 12 13 14 15
A Z O N E 9 5 0 A C 5 2 Z A A

Brand

A = American Standard
Z = Unbranded

Accessory Type

CONT = Control (thermostat)
ZONE = Control (zoning)

Model Series

Major Design Modifications

Control Platform

M = Mechanical
N = Non-programmable Electronic (Digital Display)
F = Five/Two Programmable Electronic (Digital Display)
S = Seven Day Programmable Electronic (Digital Display)
C = Communicating
W = Wireless

Heating Stages

Cooling Stages

Equipment Application

A = AC / Heat (Gas or Electric)
G = AC / Heat (Gas)
E = AC / Heat (Electric)
H = Heat Pump
M = Multi-Application - AC / Heat (Gas/Elec) / Heat Pump
D = Dual Fuel, Heat Pump, or AC and Heat (Gas/Elec)
C = Communicating
Z = Zoning - Universal application - 3 wire Communicating zone control of AC or Heat (Gas/Elec) and Dual Fuel Heat Pump
U = Universal Application - Communicating Control of AC/Heat (Gas/Elec) / Dual Fuel Heat Pump

Minor Design Change

Service Digit

Zone Dampers

1 2 3 4 5 6 7 8 9 10 11 12 13 14 15
Z D A M P R D M A 0 0 1 2 A A

Brand

Z = Zoning

Damper

Model Series

RD = Round
RR = Retro-Fit Round
SM = Side Mount Rectangular
BM = Bottom Mount Rectangular

Modulating Damper (24 Volt, 60 Sec. Timing)

Major Design Modifications

Dimensions

0012 = 12" Round
1014 = 10" X 14" Rectangular (motor mounted on 2nd dimension)

Minor Design Change

Service Digit

BUILT TO A HIGHER STANDARD[®]

American Standard[®]
HEATING & AIR CONDITIONING

Model Nomenclature Light Commercial

Commercial Condensing Units Cooling and Heat Pump

1 2 3 4 5 6 7 8 9 10 11 12
T T A 0 9 0 D 3 H R B 0

Product Type _____
TTA = Split Cooling TWA = Split Heat Pump

Nominal Gross Cooling Capacity (MBh) _____
Cooling Heat Pump
090 = 7 1/2 Tons 090 = 7 1/2 Tons
120 = 10 Tons 120 = 10 Tons
150 = 12 1/2 Tons 180 = 15 Tons
180 = 15 Tons 240 = 20 Tons
240 = 20 Tons 300 = 25 Tons

Compressor _____
D = Single Compressor (R-410A)
E = Dual Compressors (R-410A)
F = Dual Manifolded Compressors (R-410A)

Electrical Characteristics _____
3 = 208 - 230/3/60 4 = 460/3/60 W=575/3/60

Factory-Installed Options _____
0 = No Hail Guard
H = Hail Guard

Factory-Installed Options _____
0 = Packed Stock, No Options
S = Epoxy Coil
R = ReliaTel™
T = ReliaTel™ with Epoxy Coil

Minor Design Change _____

Service Digit - Not Orderable _____

Air Handler - Commercial

1 2 3 4 5 6 7 8 9 10 11 12
T W E 0 9 0 D 1 0 0 A 0

Product Type _____
TW = Cooling/Heat Pump

Airflow Type _____
E = Convertible – Upflow/Horizontal Only

Nominal Gross Cooling Capacity (MBh) _____
060 = 5 Tons 180 = 15 Tons
090 = 7 1/2 Tons 240 = 20 Tons
120 = 10 Tons 300 = 25 Tons
150 = 12 1/2 Tons

Refrigeration Circuits _____
D = Single Circuit
E = Dual Circuit, R-410A

Electrical Characteristics _____
1 = 208-230/1/60
3 = 208-230/3/60
4 = 460/3/60

Factory Installed Options _____
00 = Packed Stock (No Options), Standard Motor - Electromechanical
03 = 2 speed VFD Standard Motor - Electromechanical Controls
04 = 2 speed VFD Oversized Motor - Electromechanical Controls
R3 = SZVAV VFD Standard Motor - ReliaTel Controls™
R4 = SZVAV VFD Oversized Motor - ReliaTel Controls™

Minor Design Change _____

Service Digit - Not Orderable _____

Model Nomenclature Light Commercial

Packaged Units

Y H C 0 3 7 E 3 R Z B * * C 0 0 0 A 1 0 0 0 0 A 1
1 2 3 4 5 6 7 8 9 10 11 12 13 14 15 16 17 18 19 20 21 22 23 24 25

Digit 1 – Unit Type

T = DX Cooling
 Y = DX Cooling, Gas Heat

Digit 2 – Efficiency

H = High Efficiency

Digit 3 – Airflow

C = Convertible

Digit 4,5,6 – Nominal Gross Cooling Capacity (MBh)

037 = 3 Tons
 047 = 4 Tons
 067 = 5 Tons

Digit 7 – Major Design Sequence

E = R-410A Refrigerant

Digit 8 – Voltage Selection

3 = 208-230/60/3
 4 = 460/60/3

Digit 9 – Unit Controls

R = ReliaTel™ Microprocessor

Digit 10 – Heating Capacity

0 = No Electric Heat G = 18 kW (1&3 phase)
 B = 6 kW (3 phase) J = 23 kW (3 phase)
 E = 12 kW (3 phase)
 L = Low Heat
 M = Medium Heat
 H = High Heat
 X = Low Heat, Stainless Steel Heat Exchanger
 Y = Medium Heat, Stainless Steel Heat Exchanger
 Z = High Heat, Stainless Steel Heat Exchanger

Digit 11 – Minor Design Sequence

A = First Sequence[Ⓢ]

Digit 12,13 – Service Sequence

**Factory Assigned

Digit 14 – Fresh Air Selection

0 = No Fresh Air
 A = Manual Outside Air Damper 0-50%[Ⓢ]
 B = Motorized Outside Air Damper 0-50%
 C = Economizer, Dry Bulb 0-100% without Barometric Relief[Ⓢ]
 D = Economizer, Dry Bulb 0-100% with Barometric Relief[Ⓢ]
 E = Economizer, Reference Enthalpy 0-100% without Barometric Relief[Ⓢ]
 F = Economizer, Reference Enthalpy 0-100% with Barometric Relief[Ⓢ]
 G = Economizer, Comparative Enthalpy 0-100% without Barometric Relief[Ⓢ]
 H = Economizer, Comparative Enthalpy 0-100% with Barometric Relief[Ⓢ]
 K = Low Leak Economizer, Dry Bulb with Barometric Relief
 M = Low Leak Economizer, Comparative Enthalpy with Barometric Relief
 P = Low Leak Economizer, Reference Enthalpy with Barometric Relief

- ① Standard on all variable stage units.
- ② Manual outside air damper will ship factory supplied within the unit, but must be field installed.
- ③ High pressure control is standard on all units.
- ④ Constant CFM direct drive is standard for 3-5 Ton variable stage units.

Digit 15 = 0, 6

3 Phase (3-5 ton) = High Efficiency Constant CFM

⑤ Economizer with Barometric Relief is for downflow configured units only. Order Economizer without Barometric Relief for horizontal configuration. Barometric Relief for horizontal configured units must be ordered as field installed accessory.

Digit 15 – Supply Fan/Drive Type/Motor

0 = Standard Drive[Ⓢ]
 1 = Oversized Motor
 2 = Optional Belt Drive Motor[Ⓢ]
 6 = Single Zone VAV[Ⓢ]
 7 = Multi-Speed Indoor Fan[Ⓢ]
 E = VAV Supply Air Temperature Control Standard Motor[Ⓢ]

Digit 16 – Hinged Service Access/Filters

0 = Standard Panels/Standard Filters
 A = Hinged Access Panels/Standard Filters
 B = Standard Panels/2" MERV 7 Filters
 C = Hinged Access Panels/2" MERV 7 Filters
 D = Standard Panels/2" MERV 13 Filters
 E = Hinged Access Panels/2" MERV 13 Filters

Digit 17 – Condenser Coil Protection

0 = Standard Coil
 1 = Standard Coil with Hail Guard
 2 = Black Epoxy Pre-Coated Condenser Coil
 3 = Black Epoxy Pre-Coated Condenser Coil with Hail Guard
 4 = Complete Coat™ Condenser Coil
 5 = Complete Coat™ Condenser Coil with Hail Guard

Digit 18 – Through the Base Provisions

Note: Applicable to Digit 1, T or Y models

0 = No Through the Base Provisions
 A = Through the Base Electric[Ⓢ]
 B = Through the Base Gas Piping[Ⓢ]
 C = Through the Base Electric and GasPiping[Ⓢ]

Digit 19 – Disconnect/Circuit Breaker (three - phase only)

0 = No Disconnect/No Circuit Breaker
 1 = Unit Mounted Non-Fused Disconnect[Ⓢ]
 2 = Unit Mounted Circuit Breaker[Ⓢ]

Digit 20 – Convenience Outlet

0 = No Convenience Outlet
 A = Unpowered Convenience Outlet
 B = Powered Convenience Outlet (three-phase only)[Ⓢ]

Digit 21 – Communications Options

0 = No Communications Interface
 3 = Novar 2024 Controls
 4 = Novar 3051 Controls without Zone Sensor
 5 = Novar 3051 Controls Interface with DCV
 6 = BACnet™ Communications Interface

Digit 22 – Refrigeration System Option

0 = Standard Refrigeration System[Ⓢ]
 B = Dehumidification Option[Ⓢ]

- Ⓢ Through the base electric required when ordering disconnect/circuit breaker options.
- Ⓢ Requires use of Disconnect or Circuit Breaker.

Not Available

- High Efficiency
- 3-5 ton w/Standard Indoor Motor w/460V
- ④ Standard metering devices are TXVs.
- ⑤ The return air smoke detector may not fit up or work properly on the Precedent units when used in conjunction with 3rd party accessories such as bolt on heat wheels, economizers and power exhaust. Do not order the return air smoke detectors when using this type of accessory.
- Ⓢ Return Air Smoke Detector cannot be ordered with Novar Controls.

Digit 23 – Refrigeration Controls

Note: Applicable to Digit 7 = E

0 = No Refrigeration Control[Ⓢ]
 1 = Frostat
 2 = Crankcase Heater[Ⓢ]
 3 = Frostat and Crankcase Heater[Ⓢ]

Digit 24 – Smoke Detector[Ⓢ]

0 = No Smoke Detector
 A = Return Air Smoke Detector[Ⓢ][Ⓢ]
 B = Supply Air Smoke Detector
 C = Supply and Return Air Smoke Detectors[Ⓢ][Ⓢ]
 D = Plenum Smoke Detector

Digit 25 – Monitoring Controls

0 = No Monitoring Control[Ⓢ]
 1 = Clogged Filter Switch[Ⓢ]
 2 = Fan Failure Switch[Ⓢ]
 3 = Discharge Air Sensing Tube[Ⓢ]
 4 = Clogged Filter Switch and Fan Fail Switch[Ⓢ]
 5 = Clogged Filter Switch and Discharge Air Sensing Tube[Ⓢ]
 6 = Fan Fail Switch and Discharge Air Sensing Tube[Ⓢ]
 7 = Clogged Filter and Fan Fail Switches and Discharge Air Sensing Tube[Ⓢ]
 8 = Novar Return Air Sensor[Ⓢ]
 9 = Novar 3051 Zone Sensor[Ⓢ]
 A = Condensate Drain Pan Overflow Switch
 B = Clogged Filter Switch[Ⓢ] and Condensate Drain Pan Overflow Switch
 C = Fan Failure Switch[Ⓢ] and Condensate Drain Pan Overflow Switch
 D = Discharge Air Sensing[Ⓢ] and Condensate Drain Pan Overflow Switch
 E = Clogged Filter Switch[Ⓢ], Fan Failure Switch[Ⓢ] and Condensate Drain Pan Overflow Switch
 F = Clogged Filter Switch[Ⓢ], Discharge Air Sensing Tubing and Condensate Drain Pan Overflow Switch
 G = Fan Failure Switch, Discharge Air Sensing Tubing and Condensate Drain Pan Overflow Switch
 H = Clogged Filter Switch[Ⓢ], Fan Failure Switch[Ⓢ], Discharge Air Sensing[Ⓢ] and Condensate Drain Pan Overflow Switch

Digit 26 – System Monitoring Controls

0 = No Monitoring Controls
 A = Demand Control Ventilation (CO₂)[Ⓢ][Ⓢ]
 B = Fault Detection and Diagnostics (FDD)
 C = Fault Detection and Diagnostics (FDD) with Demand Control Ventilation

Digit 27 – Unit Hardware Enhancements

0 = No Enhancements
 1 = Stainless Steel Drain Pan

Digit 31 – Advanced Unit Controls

0 = Stainless Steel Drain Pan
 1 = Human Interface

- Ⓢ These options are standard when ordering Novar Controls.
- Ⓢ This option is used when ordering Novar Controls.
- Ⓢ Includes gas piping and shutoff (field assembly required).
- Ⓢ Not available with high temperature duct sensor accessory.
- Ⓢ Novar Sensor utilized with Digit 21 = (4) Novar 3051 Controls without Zone Sensor.
- Ⓢ Available for T/Y 3,4,5 ton high efficiency models.
- Ⓢ Requires selection of 2" Pleated Filters (option B or C) for Digit 16.

For complete equipment / combination selections, installation instructions and warranty information, please refer to Product Data/Ratings and/or Installers Guides and Limited Warranty Handbooks.

Model Nomenclature Light Commercial

G A C 1 8 0 A 3 E Z A 0 0
1 2 3 4 5 6 7 8 9 10 11 12 13

Digit 1 – Unit Type

E = Packaged Cooling, Electric Heat
G = Packaged Cooling, Electric Heat

Digit 2 – Efficiency

A = ASHRAE 90.1 - 2010

Digit 3 – Airflow Configuration

C = Convertible
D = Downflow Only^④

Digit 4, 5, 6 – Nominal Gross Cooling Capacity (MBh)

180 = 15 Tons
210 = 17½ Tons
240 = 20 Tons
300 = 25 Tons

Digit 7 – Major Design Sequence

A

Digit 8 – Voltage Selection

3 = 208-230/60/3
4 = 460/60/3
K = 380/60/3
W = 575/60/3

Digit 9 – Unit Controls

E = Electromechanical

Digit 10 – Heating Capacity

Note: (Applicable to Digit 1 E models only)

0 = No Heat
G = 18 kW Electric Heat
N = 36 kW Electric Heat
P = 54 kW Electric Heat
R = 72 kW Electric Heat

Note: (Applicable to Digit 1 G models only)

H = Gas Heat - High^①
L = Gas Heat - Low
M = Gas Heat - Medium
X = Gas Heat - SS Ht Ex - Low
W = Gas Heat - SS Ht Ex - Medium
Z = Gas Heat - SS Ht Ex - High^④

Digit 11 – Minor Design Sequence

Digit 12-13 – Service Sequence

0 = None

Digit 14 – Fresh Air Selection

0 = No Fresh Air
A = Manual Outside Air Damper 0-50%
B = Motorized Outside Air Damper 0-50%
C = Economizer, Dry Bulb 0-100% without Barometric Relief
D = Economizer, Dry Bulb 0-100% with Barometric Relief^①
E = Economizer, Reference Enthalpy 0-100% without Barometric Relief
F = Economizer, Reference Enthalpy 0-100% with Barometric Relief^①
G = Economizer, Comparative Enthalpy 0-100% without Barometric Relief
H = Economizer, Comparative Enthalpy 0-100% with Barometric Relief^①

Digit 15 – Supply Fan/Drive Type/Motor

0 = Standard Motor
1 = Oversized Motor
7 = Multi-Speed Standard Motor
9 = Multi-Speed Oversized Motor

Digit 16 – Not Used

Digit 17 – Condenser Coil Protection

0 = Standard Coil
4 = CompleteCoat™ Condenser Coil

Digit 18 – Through The Base Provisions

Note: (Applicable to Digit 1, E models)
0 = No Through The Base Provisions
A = Through The Base Electric

Note: (Applicable to Digit 1, G models only)

0 = No Through The Base Provisions
A = Through The Base Electric
B = Through The Base Gas^①
C = Through The Base Electric/Gas

Digit 19 – Disconnect Switch

0 = No Disconnect/circuit break
1 = Unit Mounted Non-Fused Disconnect Switch^②

Digit 20 – Not Used

Digit 21 – Not Used

Digit 22 – Not Used

Digit 23 – Not Used

Digit 24 – Not Used

Digit 25 – System Monitoring Controls

0 = No Monitoring Controls
A = Condensate Drain Pan Overflow Switch

^① Some field set up required.

^② Must be ordered with Through-the-Base Electrical option.

^③ All Factory Installed Options are Built-to-Order. Check order services for estimated production cycle.

^④ High heat is available on dowflow units only.

Conventional 24 Volt Connected Controls

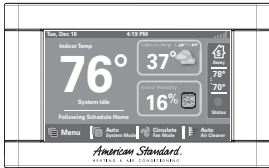

GOLD 824
ACONT824AS52DB



ACONT824AS52DB

- Energy Star[®] certified
- Connect over 200 Z-Wave devices^{①②}
- Nexia[™] Compatible with built-in Z-Wave Plus Bridge^①
- WiFi or Ethernet connection
- Control from a smartphone, tablet, or computer ^{①②}
- 4.3" diagonal color touchscreen
- 7 Day programmable with up to four schedules per day
- Five day weather forecast, weather radar, and weather alerts ^①
- Indoor relative humidity display
- Enhanced dehumidification (cooling)
- 2 Auxiliary dry contacts control 2 of the following: Whole house humidifier, dehumidifier, or ventilation system
- Test modes and alert diagnostics
- Screen access restrictions
- Nexia[™] Diagnostics ^①
- Over-the-air software upgrade ^①
- Local software upgrade option
- Silver color
- Limited Warranty: 5 yr. base/10 yr. registered

Application:

- Conventional gas/electric, heat pump, and dual fuel systems
- Conventional boiler systems (forced air only)
- Conventional HVAC systems:
- 2 Heat / 2 cool
- Heat Pump systems: Up to 5 stages heat / 2 stages cool (2 compressor heat - 3 auxiliary heat / 2 cooling)
- Heat Pump switchover valve: selectable "with cool or with heat"
- Remote wired indoor temperature sensor (optional) ZZSENSAL0400AA
- Remote wireless indoor temperature and humidity sensor (optional): ZSENS930AW00MA
- Remote wired outdoor temperature sensor (optional) BAYSEN01ATEMPA
- PWM Circuit (BK terminal): controls indoor unit variable speed blower
- Wall cover plate BAYCOVR800A

Dimensions:

- Product: 5.43"w x 3.39"h x 1.30"d
- Display: 4.15"w x 2.65"h

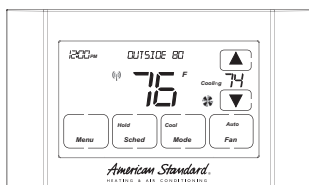

SILVER 724
ACONT724AS42DA



ACONT724AS42DA

- Nexia[™] compatible ^{①②}
- Nexia[™] Diagnostics ^①
- WiFi connectivity
- Control from a smartphone, tablet, or computer ^{①②}
- 4.3" diagonal black and white touchscreen
- 7 Day programmable with up to 4 schedules per day
- Humidity sensor and RH display
- Remote temperature sensor connections (1 indoor/1 outdoor)
- Auxiliary & compressor heat lockouts
- Auxiliary dry contact
- Enhanced dehumidification (cooling)
- PWM Circuit (BK terminal): controls indoor unit variable speed blower
- Energy Savings Mode (ESM)
- Screen lock and guest lock
- Service test modes
- Upgradable software
- Color: Designer Silver
- Limited Warranty: 1 yr. base/5 yr. registered

Application:

- Up to 4 Stages Heat/2 Stages Cool
- Conventional gas/electric, heat pump, and dual fuel systems
- Conventional boiler systems (baseboard & radiators)
- Remote wired indoor temperature sensor (optional): ZZSENSAL0400AA
- Remote wired outdoor temperature sensor (optional): BAYSEN01ATEMPA
- Wall cover plate BAYCOVR800A
- Nexia[™] Bridge is required for control of Z-Wave devices and remote climate access. The Nexia[™] Bridge is purchased separately. ^{①②}

Dimensions:

- Product: 5.9"w x 3.47"h x .95"d
- Display: 3.8"w x 2.3"h

^① Requires internet service and Nexia[™] smart home system registration.

^② Nexia[™] remote climate access is included with the purchase for up to 8 Connected Controls per home. Adding accessories or additional controls to your Nexia[™] system may require a monthly subscription.

BUILT TO A HIGHER STANDARD[®]

American Standard[®]
HEATING & AIR CONDITIONING

AccuLink™ Communicating Connected Controls

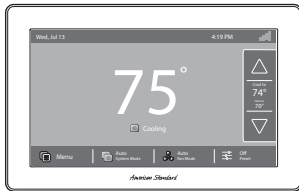

**PLATINUM 1050
AZON1050AC52ZA**



AZON1050AC52ZA

- Nexia™ compatible with Built-In Z-Wave Plus Bridge
- Connect over 200 Z-Wave devices^{①②}
- Nexia™ Diagnostics ^①
- WiFi or Ethernet connection
- Control from a smartphone, tablet, or computer ^{①②}
- 7" diagonal color touchscreen
- 1-Touch Presets - Home, Away, Sleep
- 7 Day programmable with up to four schedules per day
- Customizable Home Screen
- Runtime History
- Allergy and Quick Clean Air Cycles
- Smart Continuous Fan
- Adjustable Continuous Airflow (35-100%)
- Screen access restrictions
- Dealer Contact Widget
- Service, Filter, Humidifier, UV Light, Air Cleaner Reminders
- Five day weather forecast, weather radar, and weather alerts ^①
- Indoor relative humidity display
- Test modes and alert diagnostics
- Over-the-air Software Upgrade ^①
- Local Software Upgrade option
- Color: Designer Silver
- Limited Warranty: 5 yr. base/10 yr. registered

Application:

- AccuComfort™ Variable Speed
- AccuLink™ II Two Stage Systems
- AccuLink™ II Zoning Systems
- AccuComfort™ Variable speed outdoor cooling or heat pump unit combined with S-Series non-communicating variable speed furnace and "C" model Relay Panel
- Relay panel (BAY24VRP52DC) is required when applied with conventional systems (Gas Electric, Heat Pump, Dual Fuel, Boilers - forced air only)
- Relay Panel Supports:
 - Up to 5 stages heat, 2 stages cool
 - Connections for Remote indoor and outdoor temperature sensors
 - 3 Dry Auxiliary Contacts to control whole house humidifier, dehumidifier, or ventilation system
- Remote wired indoor temperature sensor (optional) ZZSENSAL0400AA
- Remote wireless indoor temperature and humidity sensor (optional): ZSENS930AW00MA
- Remote wired outdoor temperature sensor (optional) BAYSEN01ATEMPA

Dimensions:

- Product: 7.2" w x 4.5" h x 1.2" d
- Display: 6.1" w x 3.3" h

Application:

- AccuLink™ communicating systems (variable speed and two stage)
- Variable speed outdoor cooling combined with S-Series non-communicating variable speed furnace and "C" model Relay Panel
- Conventional gas/electric, heat pump, dual fuel systems, or boiler systems (forced air only) with use of relay panel model BAY24VRPAC52DB. Relay panel controls up to 5 stages heat, 2 stages cool, remote indoor and outdoor connections, humidifier, dehumidifier, and ventilation system.
- Remote wired indoor temperature sensor (optional) ZZSENSAL0400AA
- Remote wireless indoor temperature and humidity sensor (optional): ZSENS930AW00MA
- Remote wired outdoor temperature sensor (optional) BAYSEN01ATEMPA

Dimensions:

- Product: 5.43" w x 3.39" h x 1.30" d
- Display: 4.15" w x 2.65" h

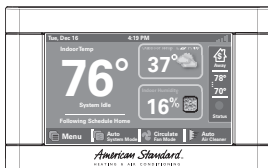

**PLATINUM 850
ACONT850AC52UA**



ACONT850AC52UA

- Nexia™ compatible with Built-In Z-Wave Plus Bridge
- Connect over 200 Z-Wave devices
- WiFi (802.11 b/g/n) or Ethernet connection
- Control from a smartphone, tablet, or computer ^{①②}
- 4.3" diagonal color touchscreen
- Compatible with AccuLink™ communicating systems (variable speed and two stage)
- Compatible with conventional 24 volt HVAC, heating, heat pump, and dual fuel systems when used with accessory relay panel model BAY24VRPAC52DB
- 7 Day programmable with up to six schedules per day
- Five day weather forecast, weather radar, and weather alerts ^①
- Indoor relative humidity display
- Test modes and alert diagnostics
- Nexia™ Diagnostics
- Upgradable software
- Silver color
- Wall Cover Plate BAYCOVR800A
- Limited Warranty: 5 yr. base/10 yr. registered

^① Requires internet service and connection to Nexia™ smart home system.
^② Nexia™ remote climate access is included with the purchase of up to 8 Connected Controls per home. Adding accessories to your Nexia™ system may require a monthly subscription for remote access via most web-enabled smartphones, tablets and computers.

For complete equipment / combination selections, installation instructions and warranty information, please refer to Product Data/Ratings and/or Installers Guides and Limited Warranty Handbooks.

Nexia™ Bridges & Starter Bundles



Nexia™ Bridge

Nexia™ BR200 Bridge

SKU: 811097020433

- Includes Nexia™ BR200 Bridge (Z-Wave to broadband), ethernet cable, and power supply
- The Nexia™ Bridge allows remote access of Z-Wave enabled devices through your smart phone, tablet, or P.C.
- Secure Connection with server for homeowner protection
- Easy Installation and Set-Up

Application:

Use with Nexia™ compatible Z-Wave devices.

Dimensions:

- Nexia™ Bridge: 3.13"w x 4.55"d x 1.2"h
- Shipping Weight: 1 lb.



Nexia™ Home Starter Kit with Smart Energy Switch

Nexia™ Home Starter Kit

SKU: 811097020457

- Includes Nexia™ Bridge (Z-Wave to broadband), one Z-Wave plus smart energy switch, ethernet cable, and power supply
- The Nexia™ Bridge allows remote access of Z-Wave enabled devices through your smart phone, tablet, or P.C.
- Secure Connection with server for homeowner protection
- Easy Installation and Set-Up

Application:

Use with Nexia™ compatible Z-Wave devices.

Dimensions:

- Nexia™ Bridge: 3.13"w x 4.55"h x 1.2"d
- Smart Energy switch: 2.2"w x 2.2"d x 2.4"h
- Shipping Weight: 2 lbs.

Scene Controller



Nexia™ One Touch

Nexia™ One Touch

SKU: 811097020341

- Control Z-Wave smart products with the touch of a button ①
- Assign any mode or automation to any button
- 15 Programmable Presets
- Works stand-alone; no phone or computer required

Application:

- Power: 2 AAA Alkaline Batteries
- RF: 908.4 MHz
- Battery Life: Approximately 1 year
- Indoor Use Only
- Mounting: Includes screws and wall anchors

Dimensions:

- Size: 3.25"w x 4.58"h x .60"d
- Weight: 1 lb.

BUILT TO A HIGHER STANDARD[®]

American Standard[®]

HEATING & AIR CONDITIONING

Nexia™ Compatible Products

Modules



Light Dimmer Module

Light Dimmer Module

SKU: 811097020082

- Light Dimmer Module and Z-Wave Signal Repeater
- Used to control and dim plug-in incandescent lighting ⓘ

Application:

- Max load both outlets = 15 Amps, 1800 Watt resistive
- Max load Z-Wave controlled outlet = 300 Watts incandescent only
- Shipping Weight: 1 lb.



Home Appliance Module

Appliance Module

SKU: 811097020044

- Home Appliance Module and Z-Wave Signal Repeater
- Used to control small appliances and plug-in incandescent, fluorescent, and LED lighting. On/Off control ⓘ
- May be used to control/reduce standby loss from plug-in power supplies and small electronic loads ⓘ

Application:

- Max load both outlets = 15 Amps, 1800 Watt resistive
- Max load Z-Wave controlled outlet = 600 Watts incandescent, 1/2 HP, 1800 Watt resistive
- Shipping Weight: 1 lb.



Smart Energy Switch

Smart Energy Switch

SKU: 811097020464

- Z-Wave plus Smart Energy Switch with single switched outlet
- Can be scheduled or remote controlled via Nexia app on smartphone/tablet
- Physical button allows manual switch control
- Built-in Z-Wave repeater to extend wireless range up to 250ft
- Monitors energy consumption of plugged-in device and provides instant power and accumulated power consumption reports via Nexia app
- Plugs into any standard 120VAC outlet. Provides over voltage/current protection.
- For indoor use only

Application:

- Protocol: Z-Wave
- Manufacturer: Nexia
- Max load: 400W incandescent, 15A resistive, 120VAC
- Operating Temperature: 32-104°F

Unit Dimensions:

- 2.2"w x 2.2"d x 2.4"h
- Shipping weight: 1 lb.

Warranty

- 1-Year Limited Warranty

Nexia™ Compatible Products

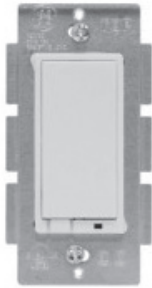

Jasco In-Wall Dimmer Switch

Dimmer Switch

SKU: 043180457127

- Turn light on/off or dim any incandescent lighting remotely from Nexia™ app ①
- Interchangeable paddles; white and light almond included in package (wall plate not included)
- Easy to install; includes space-saving screw terminals
- Automate with Nexia™ based on time of day
- Trigger actions from other smart products
- LED indicator glows in dark

Application:

- Protocol: Z-Wave
- Power: 120 VAC, 60Hz
- Max Load: 1000W, 2-gang 800W and 3-gang 600W
- Operating Temperature: 0°C-40°C
- Indoor Use Only
- Specifications subject to change without notice

Warranty

- 1-Year Limited Warranty



Jasco In-Wall On/Off Switch

On/Off Switch

SKU: 043180457097

- Turn any light on/off remotely from Nexia™ app ①
- Interchangeable paddles; white and light almond included in package (wall plate not included)
- Easy to install; includes space-saving screw terminals
- Automate with Nexia™ based on time of day
- Trigger actions from other smart products
- LED indicator glows in dark

Application:

- Protocol: Z-Wave
- Power: 120 VAC, 60Hz
- Max Load: 960W Incandescent, 1/2 HP Motor, 1800W (15A) Resistive
- Operating Temperature: 0°C-40°C
- Indoor Use Only
- Specifications subject to change without notice

Warranty

- 1-Year Limited Warranty

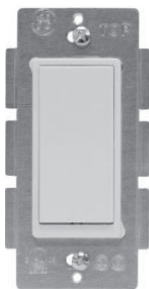

Jasco In-Wall 3-Way Add-on Switch

3-Way Add-on Switch

SKU: 043180457103

- The Jasco Add-On Switch mirrors the functionality of the Jasco switch with which it is paired. Unlike traditional lighting controls, all paired switches perform the same functions. ①
- Compatible with all In-Wall GE and Jasco Switches, Dimmers and Fan Controls
- Required for use with 3- and 4-way wiring
- Interchangeable paddles; white and light almond included in package (wall plate not included)
- Easy to install; includes space-saving screw terminals

Application:

- Protocol: Z-Wave
- Power: 120 VAC, 60Hz
- Operating Temperature: 0°C-40°C
- Indoor Use Only
- Specifications subject to change without notice

Warranty

- 1-Year Limited Warranty

BUILT TO A HIGHER STANDARD[®]

American Standard[®]

HEATING & AIR CONDITIONING

Nexia™ Compatible Products



GE In-Wall Fan Control Switch

Fan Control Switch

SKU: 030878143141

SKU: 030878127301 (Phasing out)

- Turn fan on/off and control up to three speed levels remotely from Nexia™ app
- Interchangeable paddles; white and light almond included in package (wall plate not included)
- Easy to install; includes space-saving screw terminals and neutral jumper wires
- Automate with Nexia™ based on temperature (with Z-Wave temperature sensor) or time of day
- Trigger actions from other smart products
- LED indicator glows in dark

Application:

- Protocol: Z-Wave
- Power: 120 VAC, 60Hz
- Max Load: 1.5A no more than two identical fans per switch not to exceed 1.5A resistive load - Controls Fan Motor Only - for use with split capacitor or shaded pole ceiling fan motors
- Operating Temperature: 0°C-40°C
- Indoor Use Only
- Specifications subject to change without notice



Linear In-Wall Switch

On/Off Switch

SKU: 093863122941

- Turn any light on/off remotely from Nexia™ app ⓘ
- Includes decor wall plate
- Serves as Z-Wave repeater
- Automate with Nexia™ based on time of day
- Trigger actions from other smart products
- LED indicator glows in dark

Application:

- Protocol: Z-Wave
- Power: 120 VAC, 60Hz
- Max Load: 960W Incandescent, 1/2 HP maximum
- Operating Temperature: 0°C-40°C
- Indoor Use Only
- Specifications subject to change without notice

Warranty

- 1-Year Limited Warranty



JASCO In-Wall Smart Motion Switch

In-Wall Smart Motion Switch

SKU: 030878247702

- Indoor in-wall Z-Wave light switch with integrated motion sensor
- Wirelessly trigger scenes/automations and send alerts to smartphone or tablet when motion detection has turned lights on or off.
- Can be used in 3-way and 4-way applications
- Multiple Operation Modes:
 - Occupancy - auto ON/auto OFF
 - Vacancy - manual ON/auto OFF
 - Manual - manual ON/OFF
- 3 Sensitivity Levels - low, medium, high
- Requires in-wall installation with hard-wired connections - Neutral wire REQUIRED.
- Includes white and light almond paddles (wall plate not included)

Application:

- Protocol: Z-Wave
- Manufacturer: JASCO
- Max load: 960W incandescent, 1/2 HP motor, 1800W, 120VAC
- Operating Temperature: 32-104°F

Unit Dimensions:

- 1.5"w x 1.5"d x 3.0"h

Warranty

- 1-Year Limited Warranty

For complete equipment / combination selections, installation instructions and warranty information, please refer to Product Data/Ratings and/or Installers Guides and Limited Warranty Handbooks.

Nexia™ Compatible Products

Locks and Deadbolts

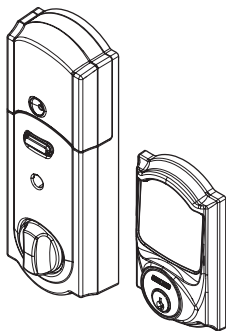

**Touchscreen Deadbolt
Camelot**

Camelot Touchscreen Deadbolt

- Motorized bolt automatically locks and unlocks when code is entered
- Anti-pick shield protects against tampering
- Built-in alarm technology
- Remotely lock/unlock from a computer or compatible web enabled mobile device ①
- Confirm lock status from a computer or compatible web enabled mobile device ①
- Assign up to 30 personalized 4-8 digit codes
- Up to 3 year battery life
- Provides battery level status at the lock and remotely ①
- Camelot touchscreen deadbolt available in Satin Nickel, Aged Bronze, Bright Brass, or Matte Black finish

Model number and finish:

- BAY469SNACAMEA - Satin Nickel
SKU: 043156312108
- BAY469ABACAMEA - Aged Bronze
SKU: 043156312191
- BAY469BBACAMEA - Bright Brass
SKU: 043156312207
- BAY469MBACAMEA - Matte Black
SKU: 04315654051

Dimensions:

- Camelot: Outside 3.0"w x 5.0"h x 1"d
Inside 3.0"w x 8.28"h x 2.0"d
- Shipping Weight: 3.8 lbs.

Warranty

- Lifetime limited mechanical and finish warranty
- 1-year limited electronics warranty

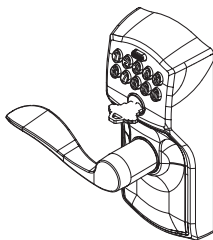

Schlage® Keypad Lever Lock

Schlage® Keypad Lever Lock

- Remotely engage/release locking mechanism from a computer or compatible web enabled mobile device ①
- Confirm lock status from a computer or compatible web enabled mobile device ①
- Assign up to 19 personalized 4 digit codes
- Up to 2 year battery life
- Provides battery level status at the lock and remotely ①
- Available in 3 finishes: Bright Brass, Satin Nickel, Aged Bronze
- Class 2 rated door lock

Model number and finish:

- BAY599BALLFEA - Bright Brass
SKU: 043156296231
- BAY599SNALLFEA - Satin Nickel
SKU: 043156296248
- BAY599ABALLFEA - Aged Bronze
SKU: 043156296255

Dimensions:

- Outside: 3.0"w x 7.0"h x 3.25"d
- Inside: 3.0"w x 8.25"h x 3.25"d
- Shipping Weight: 5.5 lbs.

Warranty

- Lifetime limited mechanical and finish warranty
- 1-year limited electronics warranty

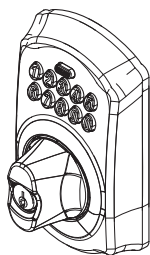

Schlage® Keypad Deadbolt Lock

Schlage® Keypad Deadbolt Lock

- Remotely engage/release locking mechanism from a computer or compatible web enabled mobile device ①
- Confirm lock status from a computer or compatible web enabled mobile device ①
- Assign up to 19 personalized 4 digit codes
- Up to 2 year battery life
- Provides battery level status at the lock and remotely ①
- Available in 3 finishes: Bright Brass, Satin Nickel, Aged Bronze
- Class 2 rated door lock

Model number and finish:

- BAY369BBADBEEA - Bright Brass
SKU: 043156295982
- BAY369SNADBEEA - Satin Nickel
SKU: 043156296187
- BAY369ABADBEEA - Aged Bronze
SKU: 043156296194

Dimensions:

- Outside: 3.25"w x 5.5"h x 3.4"d
- Inside: 3.25"w x 7.5"h x 2.5"d
- Shipping Weight: 6 lbs.

Warranty

- Lifetime limited mechanical and finish warranty
- 1-year limited electronics warranty

BUILT TO A HIGHER STANDARD[®]

American Standard[®]

HEATING & AIR CONDITIONING

Nexia™ Compatible Products

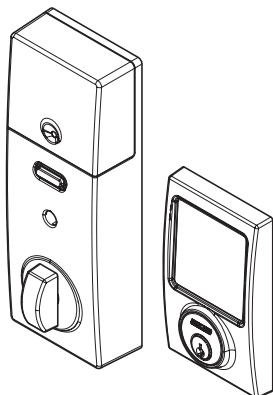

**Touchscreen Deadbolt
Century**

Century Touchscreen Deadbolt

- Motorized bolt automatically locks and unlocks when code is entered
- Anti-pick shield protects against tampering
- Built-in alarm technology
- Remotely lock/unlock from a computer or compatible web enabled mobile device ①
- Confirm lock status from a computer or compatible web enabled mobile device ①
- Assign up to 30 personalized 4-8 digit codes
- Up to 3 year battery life
- Provides battery level status at the lock and remotely ①

Model number and finish:

- BAY469SNACENEA - Satin Nickel
SKU: 043156312283
- BAY469MBACENEA - Matte Black
SKU: 043156454068

Dimensions:

- Century: Outside 3.0"w x 5.0"h x 1.0"d
Inside 3.0"w x 8.17"h x 2.0"d
- Shipping Weight: 3.8 lbs.

Warranty

- Lifetime limited mechanical and finish warranty
- 1-year limited electronics warranty

Wireless Cameras



**Wi-Fi HD Wide-Angle Indoor
Camera**

Wi-Fi HD Wide-Angle Indoor Camera

SKU: 811097020426

- Nexia™ Web Camera - Wireless
- 1080p
- Indoor, fixed camera (power supply included)
- Remotely view and monitor your home from a computer or compatible web enabled mobile device ①
- Secure Connection with server for homeowner protection
- Plug and Play with Nexia System
- infrared illumination for night vision

Application:

- Resolution: 1920 x 1080, 1280 x 720, 640 x 480, 320 x 240
- Video Compression: H.264, MJPEG
- Operating Temp: 32°F (0°C) to 113°F (45°C)
- Storage Temp: -4°F (-20°C) to 158°F (70°C)
- Wireless: IEEE 802.11b/g/n, WEP 64/128 bit, WPA/WPA2 personal security support
- Power Adapter: 12V/1A, 100~240VAC (indoor use only)

Dimensions:

- 2.8" W x 2.7" H x 1.2" D



Wi-Fi Outdoor Camera

Wi-Fi Outdoor Camera

SKU: 811097020419

- Nexia™ Web Camera - Wireless
- 720p
- Outdoor, fixed camera (power supply included)
- 300% more pixels 60% wider field (140°) of view from prior model outdoor camera
- 16GB onboard storage
- Built in motion sensor (trigger video when motion detected) and infrared illumination for night vision
- Remotely view and monitor your home from a computer or compatible web enabled mobile device ①
- Secure Connection with server for homeowner protection
- Plug and Play with Nexia System

Application:

- Resolution: 1280 x 720, 640 x 480, 320 x 240
- Video Compression: H.264, MJPEG
- Operating Temp: -4°F (-20°C) to 104°F (40°C)
- Storage Temp: -40°F (-40°C) to 158°F (70°C)
- Wireless: IEEE 802.11b/g/n, WEP 64/128 bit, WPA/WPA2 personal security support
- Power Adapter: 12V/1.5A, 100~240VAC (indoor use only)

Dimensions:

- 3.3" W x 4.8" H x 3" D

For complete equipment / combination selections, installation instructions and warranty information, please refer to Product Data/Ratings and/or Installers Guides and Limited Warranty Handbooks.

Nexia™ Compatible Products

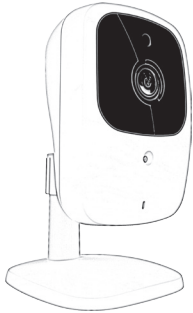

Wi-Fi Indoor Camera

Wi-Fi Indoor Camera

SKU: 811097020303

- Nexia™ Web Camera - Wireless
- 720p
- Indoor, fixed camera (power supply included)
- Remotely view and monitor your home from a computer or compatible web enabled mobile device ①
- Secure Connection with server for homeowner protection
- Plug and Play with Nexia System
- infrared illumination for night vision

Application:

- Resolution: 1280 x 720, 640 x 480, 320 x 240 (QVGA)
- Video Compression: H.264, MJPEG
- Operating Temp: 32°F (0°C) to 104°F (40°C)
- Storage Temp: -4°F (-20°C) to 158°F (70°C)
- Wireless: IEEE 802.11n/802.11b, 802.11g compatible, WEP 64/128 bit, WPA/WPA2 personal security support
- Power Adapter: 12V/1A, 100~240VAC (indoor use only)

Dimensions:

- 71mm W x 120mm H x 79mm D

Remote Temperature Sensor

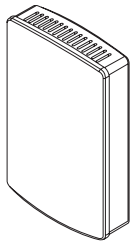

Remote Wireless Indoor Sensor

ZSENS930AW00MA

- Indoor Wireless Temperature and Humidity Sensor for use with ACONT824, ACONT850, AZON1050
- Operating Ambient Temperature Range: 32° to 104°F (0° to 40°C)
- Power Supply: Two AAA alkaline batteries
- Sensor Accuracy: +/-1°F over the sensing range of 32°F to 120°F (0° to 48.9°C)
- Operating Relative Humidity: 10% to 90% non-condensing

Dimensions in in. (mm):

- 2.0" (51)w x 3.25" (83)h x .6 (15)d
- Storage Temperature: -40° to 140°F (-40° to 65°C)
- Finish: White

Security Sensors & Alarms

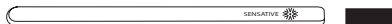

Sensative Strips Door/
Window Sensor

Sensative Strips Door/Window Sensor

SKU: 7350088520024

- Ultra thin design (less than 3 mm) for invisible mounting between most doors/windows and their frames
- Simple to set up with the included adhesive backing
- Indoor or outdoor use
- Not for use on metal surfaces which may block the signal
- Long lasting non-replaceable battery (10 year life)

Application:

- Protocol: Z-Wave
- Manufacturer: Sensative

Application:

- Indoor Range: 130 ft.
- Magnetic Range: 0.6"
- Operating Temperature: -4°F-140°F (-20°C-60°C)

Dimensions:

- Sensor: 7.7"l x 0.6"w x 0.12"d
- Magnet: 1.2"l x 0.43"w x 0.04"d
- Weight: 2 oz.

Warranty

- 1-Year Limited Warranty

BUILT TO A HIGHER STANDARD[®]

American Standard[®]

HEATING & AIR CONDITIONING

Nexia™ Compatible Products

Security Sensors & Alarms

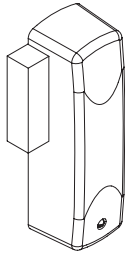

Door/Window Sensor

Door/Window Sensor

SKU: 811097020105

- Door / Window Sensor
- Reports open/closed status of doors and windows ①
- Set Nexia™ to send notification when doors or windows are opened ①
- Set Nexia™ to change the thermostat setting when windows have been opened or closed ①②
- Simple installation and set up
- Up to 3-year battery life for normal usage, no wiring required

- For indoor use
- White and brown cover available to match your door or window

Application:

- Operating Temp -0°C to 49°C
- Range: 60 ft
- Operating frequency: 908.41 MHz

Dimensions:

- 3.5"w x 1.75"h x 1"d
- Shipping weight: 1 lb

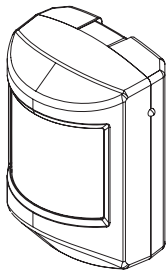

Motion Sensor

Motion Sensor

SKU: 811097020112

- Motion Sensor
- Text or e-mail alert when activity is detected ①
- Trigger Nexia™ compatible cameras when motion is detected ①③
- Set up to turn on lights when there is activity present ①
- Simple installation and set up
- Up to 3 year battery life
- For indoor use

Application:

- Operating Temp -0°C to 49°C
- Range: 60 ft
- Detection area: 20' * 39' (radial distance)
- Detection angle: 90 degrees
- Operating frequency: 908.41 MHz
- Pet immunity: Set at approx. 50 lbs / 22.7 kg. Optional

Dimensions:

- 3.5"w x 2.5"h x 2"d
- Shipping weight: 1 lb



Fibaro Z-Wave Multi Sensor

Z-Wave Multi Sensor

SKU: 857934005096

- Detects motion, temperature and light
- Fully integrated to trigger Nexia™ Automations
- Multiple LED options for signaling motion detection
- Tamper and low-battery alarm notifications
- Easy installation, no wiring required
- Powered by CR123A, 3.6v battery
- Recommended installation height is 2.4 m or 7' 7/8"

Application:

- Operating Temp - 0°C to 40°C
- Range: Up to 50 m outdoors, up to 30 m indoors
- Operating frequency: 908 MHz US
- Light Intensity Measuring Range: 0-32000 LUX
- Measured Temp Range:-20 - 100°C
- Temperature Measuring Accuracy: 0.5°C (within 0°C to 40°C range)

Dimensions:

- 1.732" x 1.732" x 1.732"
- Shipping weight: 1 lb

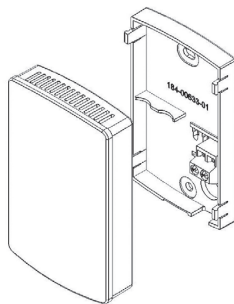

Z-Wave Doorbell Sensor

Z-Wave Doorbell Sensor

SKU: 811097020396

- Detects and alerts when doorbell button is pressed
- Fully integrated to trigger Nexia™ Automations
- Easy installation

Application:

- Power: 2 AAA Alkaline Batteries
- RF: Z-Wave ZM5202, US 908.4 MHz
- Doorbell Connection: 2 Wire Polarized
- Voltage: 14-40 VAC
- Wire Input: 16-24 Ga Solid Wire

Dimensions:

- 3.2" x 2.0" x 0.60"
- Weight: .25 lb

- ① Requires internet service and Nexia™ smart home system registration.
- ② Requires Nexia™ compatible connected control
- ③ Requires Nexia™ compatible camera

For complete equipment / combination selections, installation instructions and warranty information, please refer to Product Data/Ratings and/or Installers Guides and Limited Warranty Handbooks.

Nexia™ Compatible Products



Dome Water Leak Sensor

Dome Water Leak Sensor

SKU: 078501401693-2

- Place near washing machines, dishwashers, sinks and toilets to alert if any leaks
- Audible alarm (beeps) and sends Z-Wave notification when water is detected
- Thin profile fits under appliances and in tight spaces
- Optional remote sensor probe with 4ft extension for hard-to-reach areas
- Up to 3 year battery life with low battery alert

Application:

- Protocol: Z-Wave
- Manufacturer: Dome
- Power: CR2 3.0V (Included)
- Operating Temperature: 32-104°F

Dimensions:

- 2.6"dia. x 1.0"h

Warranty

- 1-Year Limited parts & labor



Ecolink Garage Tilt Sensor

Ecolink Garage Tilt Sensor

SKU: 851166005107

- Wirelessly transmits garage door position status (open or closed) via Z-Wave
- Intended for multi-section garage doors
- Easily mounts directly to inside of garage door (top section) via mounting screws or double-sided tape
- 5-8 year battery life

Application:

- Protocol: Z-Wave
- Manufacturer: Ecolink
- Power: CR123A 3.0V Lithium
- Operating Temperature: 32-120°F

Dimensions:

- 1.7" h x 3.0" w x 1.0" d

Warranty

- 3 years



GE Outdoor Module

GE Outdoor Module

SKU: 043180456588

- Wirelessly schedule and control outdoor lighting and appliances, including seasonal and landscape lighting, fountains and pumps from anywhere
- Contains one Z-Wave outlet and a manual switch for On/Off control
- Weather and impact resistant enclosure
- Built-in mounting bracket

Application:

- Protocol: Z-Wave
- Manufacturer: General Electric (GE)
- Max load: 600W incandescent, ½ HP motor, 120VAC
- Operating Temperature: 32-104°F

Dimensions:

- 5.5"h x 4.0"w x 2.5"d

Warranty

- 1-Year Limited

BUILT TO A HIGHER STANDARD[®]**American Standard**[®]

HEATING & AIR CONDITIONING

Nexia™ Compatible Products

**Linear Siren and Strobe****Linear Siren and Strobe**

SKU: 093863125058

- Z-Wave Sounder/Strobe
- 105DB at 1m
- 360 lumen, 4 LED strobe light
- Battery backup
- Siren only/strobe only/siren and strobe modes
- For non-life safety applications

Application:

- Protocol: Z-Wave
- Manufacturer: Linear
- Manufactured in Taiwan

Unit Dimensions:

- 3" x 4.6" x 1.6"
- Shipping weight: 11 oz

Case Dimensions:

- Quantity - 18 units
- 11" x 11" x 15"
- Shipping weight: 2 lbs, 9 oz

Warranty

- 1-Year Limited Warranty

**Smoke/Carbon Monoxide Alarm****Smoke/Carbon Monoxide Alarm**

SKU: 029054013026

- Combination Smoke & Carbon Monoxide Alarm
- Set Nexia™ to send alerts when alarm is triggered ①
- Photoelectric smoke sensor helps reduce false alarms such as from cooking or shower steam
- Mute unwanted alarms or test the alarm function with a simple button push
- 2 AA batteries included
- 1-year limited warranty

Application:

- Protocol: Z-Wave
- Manufacturer: First Alert
- Manufactured in Mexico

Unit Dimensions:

- 8.75"w x 7"h x 2.5"d
- Shipping weight: 11 oz

Case Dimensions:

- Quantity - 3 units
- 9"w x 7"h x 7.6"d
- Shipping weight: 2 lbs, 9 oz

Warranty

- 1-Year Limited Warranty

For complete equipment / combination selections, installation instructions and warranty information, please refer to Product Data/Ratings and/or Installers Guides and Limited Warranty Handbooks.

Nexia™ Compatible Products

FortrezZ Water Valves

Indoor Actuator



Indoor Actuator
 SKU: 045635411890
 Indoor Actuator

- Remotely operated Z-Wave water valve compatible with Nexia™ smart home systems ①
- Automatically turns off main water supply when a water event is detected
- Select 3/4", 1", or 1-1/4" brass water valve for use with indoor actuator
- Can be used as irrigation device
- Multiple valves can be used and programmed in a Z-Wave Network
- Meets the standard of most state and municipal authorities
- Two tactile switches to manually activate the valve
- Ask insurance company for specific details about premium discounts for flood protection

Brass Water Valves



Brass Ball Water Valves
 SKU: 045635411852
 3/4" Brass Valve
 SKU: 045635411869
 1" Brass Valve
 SKU: 045635411876
 1-1/4" Brass Valve

Outdoor actuator



Outdoor Water Valve Variants
 SKU: 661799563253
 Outdoor actuator and indoor control with 25' cable ②③
 SKU: 661799563260
 Outdoor actuator and indoor control with 50' cable ②③
 SKU: 661799563284
 Outdoor actuator and indoor control with 75' cable ②③

Brass Water Valves



Brass Ball Water Valves
 SKU: 045635411852
 3/4" Brass Valve ④
 SKU: 045635411869
 1" Brass Valve ④
 SKU: 045635411876
 1-1/4" Brass Valve ④

- ① Requires internet service and Nexia™ smart home system registration.
- ② Used with brass ball valves (ordered separately)
- ③ For applications that require outside installation above or below grade with temporary submersion at limited depth. See installation instructions for details.
- ④ Used with outdoor water valve variant (ordered separately)

BUILT TO A HIGHER STANDARD[®]

American Standard[®]

HEATING & AIR CONDITIONING

Nexia™ Compatible Products

FortrezZ Flood and Temperature Sensor



Flood and Temperature Sensor

SKU: 045635411760

- Compatible with Nexia™ smart home system ①
- When the sensor is used with Nexia™ and FortrezZ water valves it will signal the valve to automatically turn off the water supply, eliminating further flooding. Sensor also monitors temperature.
- Checks for leaks every 4 seconds
- Calibrated to prevent false alarms.
- Works with both well or city water.
- Gold plated sensing probes for corrosion resistance
- Sensor floats and continues to alert for up to 24 hours.
- 2 x AA Alkaline batteries last up to 2 years
- Low Battery Alerts to remind you to change batteries
- LED indicator

Specifications:

- Power: 2xAA alkaline batteries
- Operating temperature: 14 deg F to 158 deg F
- Temperature report: +/- 2 deg C accuracy
- System Requirement: Any Z-Wave enabled network

Unit Dimensions:

- 2.1"w x 3.0"h x 1.1"d
- Weight: 0.24lbs w/ batteries installed

Garage Door Controller



Garage Door Controller

Garage Door Controller

SKU: 093863133206

- Fully supported by Nexia™ web and mobile applications ①
- Actuates a garage door opener remotely
- AC line powered
- Includes battery-powered Tilt Sensor that is mounted on the garage door that reports door position
- Produces audible and visual signals for safety purposes
- Certified to ETL Standard for Moving Barriers, Z-Wave Standards and Nexia™ product certification standards
- Easy installation
- Integrates with most existing multi-section doors (after 1993) and suitable for installation on existing or new garage door opening systems of many brands
- Does not include garage door opener, or garage door

- Compatible with most garage door openers that accept a standard push button input. Not compatible with openers using a proprietary communication protocol to the wall switch such as Genie Series II and the Chamberlain/Liftmaster MyQ system.

Unit Dimensions:

- 9.27"w x 7.04"h x 4.5"d
- Shipping weight: 2 lbs

For complete equipment / combination selections, installation instructions and warranty information, please refer to Product Data/Ratings and/or Installers Guides and Limited Warranty Handbooks.

① Requires internet service and Nexia™ smart home system registration.

Nexia™ Compatible Products

Dome Z-Wave Products



Dome Mouser

Dome Mouser

SKU: 078501401696-3

- Electronic mouse trap
- Battery powered: requires four AA Batteries (not included)
- Battery life: 2 years
- 50 zaps per set of batteries
- Safe for pets and kids

Application:

- Protocol: Z-Wave
- Manufacturer: Dome

Unit Dimensions:

- 8.5" x 4.5" x 5"

Warranty

- 1-Year Limited Warranty



Dome Multi-Chime Siren

Dome Multi-Chime Siren

SKU: 078501401710-6

- Siren mounts on wall, tabletop, or shelftop
- Controllable volumes, tones, and LEDs
- Binary switch (Siren)
- Indicator (Chimes)
- Notifications (Siren)
- 2xCR123 3.0V battery
- Range: Up to 150'

Application:

- Protocol: Z-Wave
- Manufacturer: Dome

Unit Dimensions:

- 2.75"dia. x 1.2"h

Warranty

- 1-Year Limited Warranty

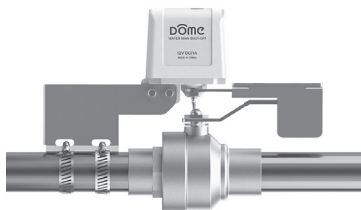

Dome Water Main Shut-Off

Dome Water Main Shut-Off

SKU: 078501401697-0

- Installs on any 1/2" to 1-1/2" size 1/4 turn flat handle brass ball valve
- Open or close any valve remotely when given a signal
- Install over existing valve
- Installation requires only a screwdriver
- Power supply: 12 VDC
- Operating Range: 32°F - 112°F (0°C-44°C)
- Range: Up to 150'

Application:

- Protocol: Z-Wave
- Manufacturer: Dome

Unit Dimensions:

- 2.5" x 3.5" x 6"

Warranty

- 1-Year Limited Warranty

Note: Actuator only. Valve not included.

Fibaro Button

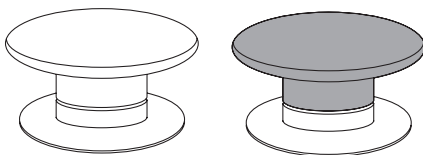

Fibaro Button

SKU: 857934005133 - White

SKU: 857934005270 - Black

- Control Z-Wave devices with 1 to 5 clicks or by holding the button down
- Wireless remote for Z-Wave devices
- Use to control or run automations
- Battery Type: ER14250 1/2AA

Application:

- Battery Life: Approximately 2 years
- Indoor Use
- Mounting to any surface
- Indoor Range: 131 ft.
- Outdoor Range: 164 ft
- Operating Temperature: 32°F-104°F (0°C-40°C)

Dimensions:

- Size: 1.9"dia. x 1.4"h
- Weight: 1 lb

For complete equipment / combination selections, installation instructions and warranty information, please refer to Product Data/Ratings and/or Installers Guides and Limited Warranty Handbooks.

BUILT TO A HIGHER STANDARD™

American Standard
HEATING & AIR CONDITIONING

AccuComfort™ Variable Speed Cooling Single Phase - 2-5 Tons



**Platinum 20
(Variable Speed)**

Table SC-1-A — Platinum 20 R-410A AccuComfort™ Variable Speed Cooling (30–100% capacity)—with AccuLink™ ①

Model Number	Power Supply	Nom. Cap Cooling (BTUH)	Uncrated Dimensions(in.)			Shipping Weight (lbs.)	Sound** Rating	MCA*	Max. Fuse*	Line Size (in)	
			H	W	D					OD Gas	OD Liq.
4A7V0024A1000C	208/230/1/60	24,600	41	33	30	217	57/66	17	25	5/8	3/8
4A7V0036B1000C	208/230/1/60	35,000	41	37	34	228	59/70	18	25	3/4	3/8
4A7V0048A1000C	208/230/1/60	47,000	41	37	34	270	57/74	23	35	7/8	3/8
4A7V0060A1000C	208/230/1/60	54,000	45	37	34	284	62/75	27	40	1 1/8	3/8
4A7V0061A1000C	208/230/1/60	55,000	45	37	34	314	62/75	27	40	1 1/8	3/8



**Platinum 18
(Variable Speed)**

Table SC-1-B — Platinum 18 R-410A AccuComfort™ Variable Speed Cooling (30–100% capacity)—with AccuLink™ ①

Model Number	Power Supply	Nom. Cap Cooling (BTUH)	Uncrated Dimensions(in.)			Shipping Weight (lbs.)	Sound** Rating	MCA*	Max. Fuse*	Line Size (in)	
			H	W	D					OD Gas	OD Liq.
4A7V8024A1000B	208/230/1/60	24,600	41	33	30	217	57/66	17	25	5/8	3/8
4A7V8036B1000B	208/230/1/60	35,400	41	33	30	228	55/70	18	25	3/4	3/8
4A7V8037A1000B	208/230/1/60	35,000	41	37	34	248	59/70	18	25	3/4	3/8
4A7V8048A1000B	208/230/1/60	47,000	41	37	34	270	57/74	23	35	7/8	3/8
4A7V8060A1000B	208/230/1/60	54,000	45	37	34	284	62/75	27	40	1 1/8	3/8

① Must use ACONT850, AZONE950 or AZON1050 control.

* Information subject to change. Please confirm with current Product Data/Service Facts for current factory production.

** Rated in accordance with AHRI Standard 270-2008 (Min/Max when applicable).

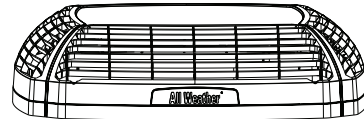

ALL WEATHER™ TOP ACCESSORY

BAYAWGR0003 - Fits base sizes 33"x30" (WxD)

BAYAWGR0004 - Fits base sizes 37"x34" (WxD)

Split System Cooling

AccuComfort™ Variable Speed Cooling Single Phase – 2-5 Tons

Split System Cooling

Table SC-2-A — Features

	Platinum 20 (4A7V0)	Platinum 18 (4A7V8)
• SEER up to	22.00	18.00
• Duration™ compressor	1	1
• Number of stages	Variable	Variable
• Comfort-R™ mode approved	✓	✓
• AccuLink™ system	✓	✓
• DuraBase™ base, fast complete drain, weatherproof	✓	✓
• Easy-Sess™ cabinet, service access	✓	✓
• Spine Fin™ coil	✓	✓
• Compressor sound enclosure	✓	✓
• Compressor sump heat	✓	✓
• Factory supplied charge	R-410A	R-410A
• Glossy corrosion resistant finish	✓	✓
• High pressure switch	✓	✓
• Low pressure switch	✓	✓
• Internal high / low pressure & temperature protection	✓	✓
• Liquid line filter drier - factory installed or factory supplied for field install	✓	✓
• Seacoast shield - factory installed	✓	—
• Spinnaker gray cabinet	✓	✓
• 12-year limited warranty on compressor, 10-year on outdoor coil & all other functional parts (Residential Use)	✓	✓
• Extended warranties available	✓	✓

Table SC-2-B — Optional Accessories

Model Number	Description	Shipping Weight		
BAYECMT023	Extreme Conditions Mounting Kit (Base 2/3)	2	2	2-3
BAYECMT004	Extreme Conditions Mounting Kit (Base 4)	2	3-5	037-060
BAYISLT101	Rubber Isolators	1	✓	✓
BAYVEN002	Enhanced Sound Enclosure	2	✓	✓
BAYLEGS007	Snow Legs - 7" High (Black)	1	✓	✓
BAYLEGS004	Snow Legs - 4" High (Black)	1	✓	✓
BAYVDTA003	Vertical Discharge Air Kit Base 3	10	2	—
BAYVDTA004	Vertical Discharge Air Kit Base 4	10	3-5	—
BAYSEAC001	Seacoast Kit	1	—	✓
PAI00309①	Heresite Spraypaint	1	✓	✓
BAYAWGR0004	All Weather™ Top - Fits unit base size of (W x D) of 37" X 34"		034-060	037-060
BAYAWGR0003	All Weather™ Top - Fits unit base size of (W x D) of 33" X 30"		024	024-036

Comfort Controls — See Comfort Controls/Zone Sensors Section

① Used for additional seacoast corrosion protection. Refer to bulletin number UN-SVB11A-EN for application information.

BUILT TO A HIGHER STANDARD™

American Standard
HEATING & AIR CONDITIONING

Split System Cooling Single Phase – 1½-5 Tons

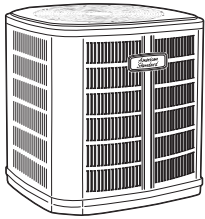

**Gold 17
(Two Stage)**

Table SC-3-A — Gold 17 R-410A Split System Two Stage Cooling (70/100% capacity)

Model Number	Power Supply	Nom. Cap. Cooling (BTUH)	Uncrated Dimensions(in.)			Shipping Weight (lbs.)	Sound** Rating	MCA*	Max. Fuse*	Line Size (in)	
			H	W	D					OD Gas	OD Liq.
4A7A7024A1000B	208/230/1/60	24,000	41	37	34	276	72	15	25	5/8	3/8
4A7A7036A1000B	208/230/1/60	36,000	45	37	34	283	72	20	35	3/4	3/8
4A7A7048B1000A	208/230/1/60	48,000	45	37	34	296	73	28	45	7/8	3/8
4A7A7060A1000B	208/230/1/60	60,000	45	37	34	312	74	37	60	1 1/8	3/8

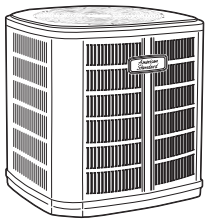

**Silver 16
(Single Stage)**

Table SC-3-B — Silver 16 R-410A Split System Single Stage Cooling

Model Number	Power Supply	Nom. Cap. Cooling (BTUH)	Uncrated Dimensions(in.)			Shipping Weight (lbs.)	Sound** Rating	MCA*	Max. Fuse*	Line Size (in)	
			H	W	D					OD Gas	OD Liq.
4A7A6018J1000A	208/230/1/60	18,000	29	33	30	189	73	12	20	3/4	3/8
4A7A6024J1000B	208/230/1/60	24,000	29	33	30	190	71	13	20	3/4	3/8
4A7A6030J1000A	208/230/1/60	30,000	37	33	30	220	71	17	25	3/4	3/8
4A7A6036J1000A	208/230/1/60	36,000	37	37	34	246	69	18	30	3/4	3/8
4A7A6042J1000A	208/230/1/60	42,000	45	37	34	302	70	21	35	7/8	3/8
4A7A6048J1000A	208/230/1/60	47,000	45	37	34	306	70	24	40	7/8	3/8
4A7A6049J1000A	208/230/1/60	48,000	45	37	34	322	70	26	40	7/8	3/8
4A7A6060J1000B	208/230/1/60	57,500	45	37	34	327	70	32	50	1 1/8	3/8
4A7A6061J1000B	208/230/1/60	60,000	45	37	34	327	74	32	50	1 1/8	3/8

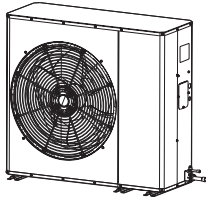

**Silver 16
(Single Stage)**

Table SC-3-C — Silver 16 R-410A Side Discharge Single Stage Cooling

Model Number	Power Supply	Nom. Cap. Cooling (BTUH)	Uncrated Dimensions(in.)			Shipping Weight (lbs.)	Sound** Rating	MCA*	Max. Fuse*	Line Size (in)	
			H	W	D					OD Gas	OD Liq.
4A7L6018A1000AⓈ	208/230/1/60	18,000	36	40	15	165	70	12	20	3/4	3/8
4A7L6024A1000AⓈ	208/230/1/60	23,000	36	40	15	165	70	13	20	3/4	3/8
4A7L6030A1000AⓈ	208/230/1/60	29,000	36	40	15	180	71	17	25	3/4	3/8
4A7L6036A1000AⓈ	208/230/1/60	35,000	36	47	18	242	72	19	30	3/4	3/8
4A7L6042A1000AⓈ	208/230/1/60	41,000	36	47	18	243	73	22	35	7/8	3/8
4A7L6048A1000AⓈ	208/230/1/60	47,000	36	47	18	243	73	24	40	7/8	3/8
4A7L6060A1000AⓈ	208/230/1/60	57,000	42	47	18	263	73	31	50	1-1/8	3/8

Ⓢ For coastal applications where units are installed within one (1) mile of salt water, epoxy coated models are available for order.

Model numbers with "COT" in the eleventh (11) through thirteenth (13) digits represent an epoxy coated coil.

Example: 4A7L6036A1COTA These models have an 8 week lead time after order.

* Information subject to change. Please confirm with current Product Data/Service Facts for current factory production.

** Rated in accordance with AHRI Standard 270-2008 (Min/Max when applicable).

Split System Cooling

Split System Cooling Single Phase - 1½-5 Tons

Split System Cooling

Table SC-4-A — Features

	Gold 17 (4A7A7)	Silver 16 (4A7A6)	Silver16 (4A7L6)
• SEER up to.....	18.00	17.00	17.00
• Duration™ compressor.....	✓	✓	✓
• Number of stages	2	1	1
• Comfort-R™ mode approved	✓	✓	✓
• DuraBase™ base, fast complete drain, weatherproof.....	✓	✓	—
• Easy-Sess™ cabinet, service access.....	✓	✓	—
• Spine Fin™ coil	✓	✓	—
• Coppe Tube, Aluminum Fin coil	—	—	✓
• Factory supplied charge	R-410A	R-410A	R-410A
• Glossy corrosion resistant finish	✓	✓	✓
• High pressure switch.....	✓	✓	✓
• Internal high / low pressure & temperature protection	✓	✓	✓
• Liquid line filter drier - factory installed or factory supplied for field install.....	✓	✓	✓
• Quick start kit-factory installed.....	—	1½-2	—
• Spinnaker gray cabinet.....	✓	✓	✓
• 12-year limited warranty on compressor,10-year on outdoor coil & all other functional parts (Residential Use)	✓	—	—
• 10-year limited warranty on compressor,10-year on outdoor coil & all other functional parts (Residential Use)	—	✓	✓
• Extended warranties available	✓	✓	✓

Table SC-4-B — Optional Accessories

Model Number	Description	Shipping Weight			
AY28X079.....	Evap. Defrost Control Kit.....	1	✓	✓	✓
BAYCCHT301RES.....	Crankcase Heater Kit (Scroll).....	1	4-5	3½-5	3½-5
BAYCCHT302RES.....	Crankcase Heater Kit (Scroll).....	1	2-3	1½-3	1½-3
BAYECMT023	Extreme Conditions Mounting Kit (Base 2/3).....	2	—	1½-2½	—
BAYECMT004	Extreme Conditions Mounting Kit (Base 4)	2	✓	3-5	—
BAYISLT101	Rubber Isolators.....	1	✓	✓	✓
BAYSKT263	Start kit	1	2-3	2½-5	2½-5
BAYSKT266	Start kit.....	1	4-5	—	—
BAYLEGS007	Snow Legs - 7" High (Black).....	1	✓	✓	✓
BAYLEGS004	Snow Legs - 4" High (Black).....	1	✓	✓	✓
BAYLOAM107A	Low Ambient Kit.....	1	✓	✓	✓
BAYSDEN003	Small Scroll Compressor Enclosure.....	8	—	1½-3	1½-3
BAYSDEN004	Small Scroll Compressor Enclosure.....	8	—	3½-5	3½-5
BAYSEAC001	Seacoast Kit.....	1	✓	✓	—
BAYSDHG002A.....	Hail Guard Kit.....	5	—	—	1½-2½
BAYSDHG003A.....	Hail Guard Kit.....	5	—	—	3-4
BAYSDHG004A.....	Hail Guard Kit.....	5	—	—	5
BAYWIND102.....	Wind Baffle Kit.....	—	—	—	5
BAYWIND103.....	Wind Baffle Kit.....	—	—	—	3-5
TAYASCT501A①②.....	Anti-Short Cycle Timer.....	2	✓	✓	—
AAYSVPANL0032AA.....	Service Valve Panel Cover Kit.....	2	—	1½-2	—
AAYSVPANL3343AA.....	Service Valve Panel Cover Kit.....	2	2	—	—
AAYSVPANL0044AA.....	Service Valve Panel Cover Kit.....	2	3-5	2½-3	—
AAYSVPANL0046AA.....	Service Valve Panel Cover Kit.....	2	—	3½-5	—
PAI00309③.....	Heresite Spraypaint.....	1	✓	✓	✓
BAYSKIT014A.....	Stacking Kit.....	—	1½	2-2½	✓
BAYSKIT018A.....	Stacking Kit.....	—	3-3½	4-5	✓
BRK05033④.....	Wall Mount Kit.....	—	—	—	✓
BAYAWGR0004.....	All Weather™ Top - Fits unit base size of (W x D) of 37" X 34".....	—	✓	036-061	—
BAYAWGR0003.....	All Weather™ Top - Fits unit base size of (W x D) of 33" X 30".....	—	—	018-030	—

Comfort Controls — See Comfort Controls/Zone Sensors Section

- ① Not for use with programmable thermostats.
- ② Activated on power off.
- ③ Used for additional seacoast corrosion protection. Refer to bulletin number UN-SVB11A-EN for application information.
- ④ Available from Trane Parts.

BUILT TO A HIGHER STANDARD™

American Standard
HEATING & AIR CONDITIONING

Split System Cooling Single Phase – 1½-5 Tons

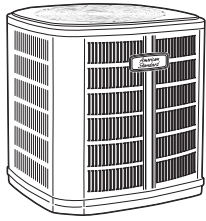

**Silver 14
(Single Stage)**

Table SC-5-A — Silver 14 R-410A Split System Single Stage Cooling

Model Number	Power Supply	Nom. Cap. Cooling (BTUH)	Uncrated Dimensions(in.)			Shipping Weight (lbs.)	Sound** Rating	MCA*	Max. Fuse*	Line Size (in)	
			H	W	D					OD Gas	OD Liq.
4A7A4018L1000A	208/230/1/60	17,000	29	29	26	153	72	12	20	3/4	3/8
4A7A4024L1000A①	208/230/1/60	23,600	29	29	26	153	71	14	20	3/4	3/8
4A7A4025L1000A	208/230/1/60	23,600	29	29	26	153	71	14	20	3/4	3/8
4A7A4030L1000A①	208/230/1/60	28,400	29	33	30	183	73	17	25	3/4	3/8
4A7A4031L1000A	208/230/1/60	28,400	29	33	30	183	71	17	25	3/4	3/8
4A7A4036L1000A①	208/230/1/60	34,000	33	33	30	183	73	18	30	3/4	3/8
4A7A4037L1000A	208/230/1/60	34,000	33	33	30	183	71	18	30	3/4	3/8
4A7A4042L1000A①	208/230/1/60	40,500	29	37	34	216	71	22	35	7/8	3/8
4A7A4043L1000A	208/230/1/60	40,500	29	37	34	216	71	22	35	7/8	3/8
4A7A4048L1000A	208/230/1/60	47,000	29	37	34	221	71	24	40	7/8	3/8
4A7A4060L1000B	208/230/1/60	56,000	37	37	34	246	71	31	45	7/8	3/8

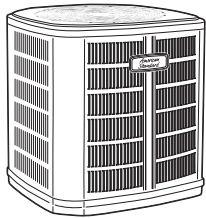

**Silver 13
(Single Stage)**

Table SC-5-B— Silver 13 R-410A Split System Single Stage Cooling

Model Number	Power Supply	Nom. Cap. Cooling (BTUH)	Uncrated Dimensions(in.)			Shipping Weight (lbs.)	Sound** Rating	MCA*	Max. Fuse*	Line Size (in)	
			H	W	D					OD Gas	OD Liq.
4A7A3018H1000N②	208/230/1/60	17,000	29	29	26	153	72	12	20	3/4	3/8
4A7A3024H1000N②	208/230/1/60	23,000	29	29	26	150	74	18	30	3/4	3/8
4A7A3030H1000N②	208/230/1/60	28,500	29	29	26	157	72	16	25	3/4	3/8
4A7A3036H1000N②	208/230/1/60	34,500	29	33	30	175	68	18	30	3/4	3/8
4A7A3042E1000N②	208/230/1/60	40,500	29	33	30	200	72	22	35	7/8	3/8
4A7A3043A1000N②	208/230/1/60	40,500	29	37	34	216	74	22	35	7/8	3/8
4A7A3048E1000P②	208/230/1/60	46,500	37	33	30	233	74	28	45	7/8	3/8
4A7A3049A1000N②	208/230/1/60	46,500	29	37	34	221	74	24	40	7/8	3/8
4A7A3060E1000N②	208/230/1/60	58,500	37	37	34	261	80	32	45	7/8	3/8

① Models are not legal for installation in California, Nevada, New Mexico and Arizona. All other models are legal for installation in all US zones and states.

② 13 SEER AC equipment manufactured after 1/1/16 can only be installed in the North Zone.

* Information subject to change. Please confirm with current Product Data/Service Facts for current factory production.

** Rated in accordance with AHRI Standard 270-2008 (Min/Max when applicable).

Split System Cooling

Split System Cooling Single Phase – 1½-5 Tons

Split System Cooling

Table SC-6-A — Features

	Silver 14 (4A7A4)	Silver 13 (4A7A3)
• SEER up to	16.00	14.75
• Duration™ compressor	✓	✓
• Number of stages	1	1
• Comfort-R™ mode approved	✓	✓
• DuraBase™ base, fast complete drain, weatherproof	✓	✓
• Easy-Sess™ cabinet, service access	✓	✓
• Spine Fin™ coil	✓	✓
• Factory supplied charge	R-410A	R-410A
• Glossy corrosion resistant finish	✓	✓
• High pressure switch	✓	✓
• Internal high / low pressure & temperature protection	✓	✓
• Liquid line filter drier - factory installed or factory supplied for field install	✓	✓
• Spinnaker gray cabinet	✓	✓
• 10-year limited warranty on compressor, outdoor coil & all other functional parts (Residential Use)	✓	✓
• Extended warranties available	✓	✓

Table SC-6-B — Optional Accessories

Model Number	Description	Shipping Weight		
AY28X079.....	Evap. Defrost Control Kit	1.....	✓	✓
BAYCCHT301RES	Crankcase Heater Kit (Scroll)	1.....	3½-5	1½-5
BAYCCHT302RES	Crankcase Heater Kit (Scroll)	1.....	1½-3	1½-3
BAYECMT023	Extreme Conditions Mounting Kit (Base 2/3)	2.....	1½-3	1½-4
BAYECMT004	Extreme Conditions Mounting Kit (Base 4)	2.....	3½-5	43,49,60
BAYISLT101	Rubber Isolators	1.....	✓	✓
BAYKSKT263	Start Kit.....	1.....	2½-5	2-5
BAYLEGS007	Snow Legs - 7" High (Black).....	1.....	✓	✓
BAYLEGS004	Snow Legs - 4" High (Black).....	1.....	✓	✓
BAYLOAM107A	Low Ambient Kit.....	1.....	✓	✓
BAYSDEN003	Small Scroll Compressor Enclosures	8.....	1½-3	1½-3
BAYSDEN004	Small Scroll Compressor Enclosures	8.....	3½-5	3½-5
BAYSEAC001	Seacoast Kit	1.....	✓	✓
TAYASCT501A①②	Anti-Short Cycle Timer	2.....	✓	✓
AAYSVPANL0022AA	Service Valve Panel Cover Kit	2.....	1½-2	1½-2½
AAYSVPANL0032AA	Service Valve Panel Cover Kit	2.....	2½,3½,4	3-4
AAYSVPANL3343AA	Service Valve Panel Cover Kit	2.....	3	—
AAYSVPANL0044AA	Service Valve Panel Cover Kit	2.....	5	5
PAI00309③.....	Heresite Spraypaint	1.....	✓	✓
BAYAWGR0004	All Weather™ Top - Fits unit base size of (W x D) of 37" X 34"		042-060	43, 49, 60
BAYAWGR0003	All Weather™ Top - Fits unit base size of (W x D) of 33" X 30"		030-037	36, 42, 48

Comfort Controls — See Comfort Controls/Zone Sensors Section

- ① Not for use with programmable thermostats.
- ② Activated on power off.
- ③ Used for additional seacoast corrosion protection. Refer to bulletin number UN-SVB11A-EN for application information.

Split System Cooling Three Phase

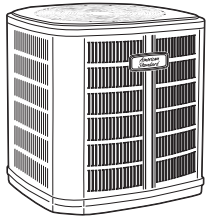

**Gold 17
(Two Stage)**

Table SC-7-A — Gold 17 - 3 Phase R-410A Split System Two Stage Cooling

Model Number	Power Supply	Nom. Cap. Cooling (BTUH)	Uncrated Dimensions(in.)			Shipping Weight (lbs.)	Sound** Rating	MCA*	Max. Fuse*	Line Size (in)	
			H	W	D					OD Gas	OD Liq.
4A7C7036A3000A	208/230/3/60	36,000	45	37	34	283	72	15	25	3/4	3/8
4A7C7048A3000A	208/230/3/60	48,000	45	37	34	285	73	18	30	7/8	3/8
4A7C7060A3000A	208/230/3/60	60,000	45	37	34	308	74	22	35	1 1/8	3/8
4A7C7036A4000A	460/3/60	36,000	45	37	34	283	72	8	15	3/4	3/8
4A7C7048A4000A	460/3/60	48,000	45	37	34	285	73	9	15	7/8	3/8
4A7C7060A4000A	460/3/60	60,000	45	37	34	308	74	10	15	1 1/8	3/8

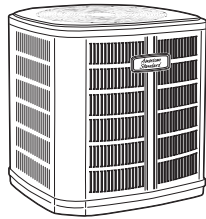

**Silver 14
(Single Stage)**

Table SC-7-B — Silver 14 - 3 Phase R-410A Split System Single Stage Cooling

Model Number	Power Supply	Nom. Cap. Cooling (BTUH)	Uncrated Dimensions(in.)			Shipping Weight (lbs.)	Sound** Rating	MCA*	Max. Fuse*	Line Size (in)	
			H	W	D					OD Gas	OD Liq.
4A7C4036A3000A	208/230/3/60	36,000	33	33	30	183	73	12	20	3/4	3/8
4A7C4042A3000A	208/230/3/60	42,000	29	37	34	216	72	15	25	3/4	3/8
4A7C4048A3000A	208/230/3/60	48,000	29	37	34	221	72	18	30	7/8	3/8
4A7C4060A3000A	208/230/3/60	60,000	37	37	34	246	72	21	35	7/8	3/8
4A7C4036A4000A	460/3/60	36,000	33	33	30	183	73	8	15	3/4	3/8
4A7C4042A4000A	460/3/60	42,000	33	37	34	216	72	8	15	3/4	3/8
4A7C4048A4000A	460/3/60	48,000	33	37	34	221	72	8	15	7/8	3/8
4A7C4060A4000A	460/3/60	60,000	41	37	34	246	72	9	15	7/8	3/8

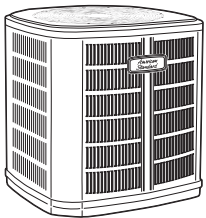

**Silver 13
(Single Stage)**

Table SC-7-C — Silver 13 - 3 Phase R-410A Split System Single Stage Cooling

Model Number	Power Supply	Nom. Cap. Cooling (BTUH)	Uncrated Dimensions(in.)			Shipping Weight (lbs.)	Sound** Rating	MCA*	Max. Fuse*	Line Size (in)	
			H	W	D					OD Gas	OD Liq.
4A7C3036B3000B	208/230/3/60	36,000	29	33	30	176	78	14	20	3/4	3/8
4A7C3042D3000D	208/230/3/60	42,000	29	37	34	228	79	18	30	3/4	3/8
4A7C3048D3000D	208/230/3/60	48,000	29	37	34	235	79	18	30	7/8	3/8
4A7C3060D3000D	208/230/3/60	60,000	37	37	34	261	80	20	35	7/8	3/8
4A7C3036B4000B	460/3/60	36,000	29	33	30	176	78	8	15	3/4	3/8
4A7C3042D4000D	460/3/60	42,000	29	37	34	228	79	8	15	3/4	3/8
4A7C3048D4000D	460/3/60	48,000	29	37	34	235	79	8	15	7/8	3/8
4A7C3060D4000D	460/3/60	60,000	37	37	34	261	80	10	15	7/8	3/8

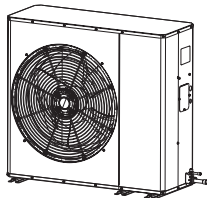

**Silver 16
(Single Stage)**

Table SC-7-D — Silver 16-410A Side Discharge Single Stage Cooling — Three Phase

Model Number	Power Supply	Nom. Cap. Cooling (BTUH)	Uncrated Dimensions (in.)			Shipping Weight (lbs.)	Sound** Rating	MCA*	Max. Fuse*	Line Size (in)	
			H	W	D					OD Gas	OD Liq.
4A7S6036A3000A①	208/230/3/60	35000	36	47	18	242	73	11	15	3/4	3/8
4A7S6048A3000A①	208/230/3/60	46500	36	47	18	243	76	18	30	7/8	3/8
4A7S6060A3000A①	208/230/3/60	56000	42	47	18	263	76	21	35	1 1/8	3/8
4A7S6036A4000A①	460/3/60	35000	36	47	18	242	73	5	15	3/4	3/8
4A7S6048A4000A①	460/3/60	46500	36	47	18	243	76	8	15	7/8	3/8
4A7S6060A4000A①	460/3/60	56000	42	47	18	263	76	10	15	1 1/8	3/8

① For coastal applications where units are installed within one (1) mile of salt water, epoxy coated models are available for order. Model numbers with "COT" in the eleventh (11) through thirteenth (13) digits represent an epoxy coated coil. Example: 4A7S6036A3COTA These models have an 8 week lead time after order.

* Information subject to change. Please confirm with current Product Data/Service Facts for current factory production.

** Rated in accordance with AHRI Standard 270-2008 (Min/Max when applicable).

First Order Date:
January 20, 2020
Units will ship from factory
30 days after order is placed.

For complete equipment / combination selections, installation instructions and warranty information, please refer to Product Data/Ratings and/or Installers Guides and Limited Warranty Handbooks.

Split System Cooling Three Phase

Split System Cooling

Table SC-8-A — Features

	Gold 17 (4A7C7)	Silver 14 (4A7C4)	Silver 13 (4A7C3)	Silver 16 (4A7S6)
• SEER up to.....	17.50	16.50	14.50	17.50
• Duration™ compressor.....	✓	✓	✓	✓
• Comfort-R™ mode approved.....	✓	✓	✓	✓
• DuraBase™ base, fast complete drain, weatherproof.....	✓	✓	✓	—
• Easy-Sess cabinet, service access & refrigerant connections with full coil protection.....	✓	✓	✓	—
• Spine Fin™ coil.....	✓	✓	✓	—
• Copper Tubing , Aluminum Fin coil.....	—	—	—	✓
• Compressor sump heat - factory installed.....	✓	✓	✓	✓
• Refrigerant (R-22 not factory supplied).....	R-410A	R-410A	R-22	R-410A
• Glossy corrosion resistant finish.....	✓	✓	✓	✓
• High pressure switch.....	✓	✓	✓	✓
• Compressor sound enclosure.....	—	—	3½	—
• Internal high / low pressure & temperature protection.....	✓	✓	✓	✓
• Liquid line filter drier - factory installed or factory supplied for field install.....	✓	✓	✓	✓
• Spinnaker gray cabinet.....	✓	✓	✓	✓
• 5-year basic limited warranty on compressor, 1-year on outdoor coil & all other functional parts (Commercial Use)	✓	✓	✓	—
• 10-year limited warranty on compressor, outdoor coil & all other functional parts (Residential Use)	✓	✓	✓	✓
• Extended warranties available	✓	✓	✓	✓

Table SH-8-B — Optional Accessories

Model Number	Description	Shipping Weight				
AY28X079.....	Evap. Defrost Control Kit.....	1.....	✓	✓	✓	✓
BAYCCHT301RES.....	Crankcase Heater Kit (Scroll).....	1.....	—	—	—	A
BAYCCHT302RES.....	Crankcase Heater Kit (Scroll).....	1.....	—	—	—	A
BAYECMT023.....	Extreme Conditions Mounting Kit (Base 2/3).....	2.....	—	3	2½-3	—
BAYECMT004.....	Extreme Conditions Mounting Kit (Base 4).....	2.....	3-5	3½-5	3½-5	—
BAYISLT101.....	Rubber Isolators.....	1.....	✓	✓	✓	✓
BAYKSKT263.....	Start Kit.....	1.....	✓	—	5	—
BAYKSKT260.....	Start Kit.....	1.....	—	—	3	—
BAYLEGS007.....	Snow Legs - 7" High (Black).....	1.....	✓	✓	✓	✓
BAYLEGS004.....	Snow Legs - 4" High (Black).....	1.....	✓	✓	✓	✓
BAYLOAM107A.....	Low Ambient Kit.....	1.....	✓	✓	✓	—
BAYSDEN001.....	Single Cylinder Compressor Enclosures.....	8.....	—	—	2½	—
BAYSDEN003.....	Small Scroll Compressor Enclosures.....	8.....	3	3	3	3
BAYSDEN004.....	Large Scroll Compressor Enclosures.....	8.....	4-5	3½-5	4-5	4-5
BAYSEAC001.....	Seacoast Kit.....	1.....	✓	✓	✓	—
BAYWIND101.....	Wind Baffle.....	—	—	—	—	3-5
TAYASCT501A①.....	Anti-Short Cycle Timer.....	2.....	✓	✓	✓	—
TAYSVPANL0032AA.....	Service Valve Panel Cover Kit.....	2.....	—	3½-4	3-4	—
TAYSVPANL3343AA.....	Service Valve Panel Cover Kit.....	2.....	—	3	2½	—
TAYSVPANL0044AA.....	Service Valve Panel Cover Kit.....	2.....	—	5	5	—
TAYSVPANL0046AA.....	Service Valve Panel Cover Kit.....	2.....	3-5	—	—	—
PAI00309②.....	Heresite Spraypaint.....	1.....	✓	✓	✓	✓
BRK05033③.....	Wall Mount Kit.....	—	✓	✓	✓	✓
BAYTWGR0004.....	All Weather™ Top - Fits unit base size of (W x D) of 37" X 34".....	—	✓	036-061	—	—
BAYTWGR0003.....	All Weather™ Top - Fits unit base size of (W x D) of 33" X 30".....	—	—	018-030	—	—

A = Factory Installed

Comfort Controls — See Comfort Controls/Zone Sensors Section

- ① Not for use with programmable thermostats.
- ② Activated on Power Off.
- ③ Used for additional seacoast corrosion protection. Refer to bulletin number UN-SVB11A-EN for application information.

Split System Heat Pumps Summary of System Ratings

IMPORTANT:

This table is intended as an at-a-glance overview. See AHRI for complete and up-to-date indoor and outdoor system ratings by model. Not all matches will attain ratings shown below.

Model Not Offered		NA-System Combination "Not Allowed"																				
Silver 14		Silver 14 - 14 SEER Single Stage Heat Pump and Air Handler Ratings Summary (up to 14 SEER / 12 EER / 8.5 HSPF)																				
		1.5 Ton			2 Ton			2.5 Ton			3 Ton			3.5 Ton			4 Ton			5 Ton		
		SEER	EER	HSPF	SEER	EER	HSPF	SEER	EER	HSPF	SEER	EER	HSPF	SEER	EER	HSPF	SEER	EER	HSPF	SEER	EER	HSPF
TEM / TMM Air Handlers	TEM4	14.00	11.50	8.50	14.00	11.50	8.50	14.00	11.50	8.50	14.00	11.50	8.50	14.00	11.50	8.50	14.00	11.50	8.50	14.00	11.50	8.50
	TMM4	NA			14.00	11.50	8.20	14.00	11.50	8.50	NA											
	TMM5	14.00	11.50	8.50	14.00	11.50	8.50	14.00	11.50	8.50	14.00	12.00	8.20									
	TEM6/8	NA			14.50	12.00	8.50	14.50	12.00	8.50	14.50	12.00	8.50	14.50	12.00	8.50	14.00	12.00	8.50	14.50	12.00	8.50
ForeFront™ Air Handlers	GAF2	14.00	11.50	8.50	14.00	11.50	8.50	14.00	12.00	8.50	14.00	12.00	8.20									
	TAM4	14.00	11.50	8.50	14.00	11.50	8.50	14.00	11.50	8.50	14.00	11.50	8.20	NA			14.00	11.50	8.50	14.00	11.50	8.50
	GAM5	14.50	12.00	8.50	14.50	12.00	8.50	14.50	12.00	8.50	14.50	12.00	8.50	14.50	12.00	8.50	14.00	12.00	8.50	14.00	11.70	8.50
	TAM9	14.50	12.00	8.50	14.50	12.00	8.50	14.50	12.00	8.50	14.50	12.00	8.50	14.50	12.00	8.50	14.50	12.00	8.50	14.50	12.00	8.50

Silver 15		Silver 15 - 15 SEER Single Stage Heat Pump and Air Handler Ratings Summary (up to 15 SEER / 12.5 EER / 9.5 HSPF)																				
		1.5 Ton			2 Ton			2.5 Ton			3 Ton			3.5 Ton			4 Ton			5 Ton		
		SEER	EER	HSPF	SEER	EER	HSPF	SEER	EER	HSPF	SEER	EER	HSPF	SEER	EER	HSPF	SEER	EER	HSPF	SEER	EER	HSPF
TEM / TMM Air Handlers	TEM4	15.00	12.50	8.50	15.00	12.50	8.50	14.25	12.00	8.50	14.50	12.00	8.50	NA			NA			NA		
	TMM4	NA			14.00	11.50	8.20	14.00	11.50	8.50	NA											
	TMM5	15.00	12.50	8.50	15.00	12.50	8.50	15.00	12.50	8.50	NA											
	TEM6/8	15.00	12.50	8.85	15.00	12.50	9.00	15.00	12.50	9.50	15.00	12.50	9.50	15.00	12.50	9.50	15.00	12.50	9.50	15.00	12.50	9.50
ForeFront™ Air Handlers	GAF2	15.00	12.50	8.50	15.00	12.50	8.50	15.00	12.50	9.50	NA											
	TAM4	15.00	12.50	8.50	15.00	12.50	9.00	14.50	12.00	9.00	14.25	12.00	9.00	14.50	12.00	8.50	15.00	12.00	8.50	14.50	12.00	8.50
	GAM5	15.00	12.50	8.50	15.00	12.50	9.00	15.00	12.50	9.50	15.00	12.50	9.50	15.00	12.50	9.00	15.00	12.50	8.50	14.50	12.00	8.50
	TAM9	15.00	12.50	9.00	15.25	12.50	9.00	15.25	12.50	9.50	15.00	12.50	9.50	15.00	12.50	9.50	15.00	12.50	9.00	15.00	12.50	9.00

Silver 16		Silver 16 - 16 SEER Single Stage Heat Pump and Air Handler Ratings Summary (up to 17 SEER / 13 EER / 9.6 HSPF)																				
		1.5 Ton			2 Ton			2.5 Ton			3 Ton			3.5 Ton			4 Ton			5 Ton		
		SEER	EER	HSPF	SEER	EER	HSPF	SEER	EER	HSPF	SEER	EER	HSPF	SEER	EER	HSPF	SEER	EER	HSPF	SEER	EER	HSPF
TEM / TMM Air Handlers	TEM4	15.00	12.50	8.50	15.00	12.00	8.20				15.00	12.00	8.20	NA			NA			14.75	12.00	8.20
	TMM5	16.00	13.00	9.00	16.00	13.00	8.50	NA			NA											
	TEM6/8	16.00	12.50	9.00	16.00	13.00	9.60	16.00	13.00	9.60	16.00	13.00	9.60	16.00	13.00	9.60	16.00	13.00	9.60	15.00	12.50	9.00
ForeFront™ Air Handlers	GAF2	16.00	13.00	8.55	14.00	12.00	8.20	NA			NA											
	TAM4	15.00	12.50	8.55	15.00	12.50	8.20	NA			14.75	12.50	8.50	15.00	12.00	8.50	15.00	12.00	8.50	15.00	12.00	8.50
	GAM5	16.00	13.00	8.55	16.00	12.50	9.00	16.00	12.50	9.00	16.00	12.50	9.00	16.00	12.50	9.00	16.00	12.50	9.00	14.50	12.00	8.20
	TAM9	17.00	13.00	9.00	17.00	13.50	9.50	17.00	13.50	9.60	16.00	13.00	9.60	17.00	13.50	9.60	16.00	13.00	9.50	15.00	12.50	9.00

Silver 16 Low Profile Side Discharge		Silver 16 - 16 SEER Low Profile Single Stage Heat Pump and Air Handler Ratings Summary (up to 16.5 SEER / 13.5 EER / 10.0 HSPF)																				
		1.5 Ton			2 Ton			2.5 Ton			3 Ton			3.5 Ton			4 Ton			5 Ton		
		SEER	EER	HSPF	SEER	EER	HSPF	SEER	EER	HSPF	SEER	EER	HSPF	SEER	EER	HSPF	SEER	EER	HSPF	SEER	EER	HSPF
TEM / TMM Air Handlers	TEM4	14.50	12.00	8.50	14.50	12.00	9.00	14.00	12.00	8.50	14.50	12.00	9.00	14.50	12.00	9.00	14.00	12.00	9.00	14.00	11.50	9.00
	TMM5	16.00	13.00	9.00	16.00	13.00	8.50	NA			NA			NA			NA			NA		
	TEM6/8	16.00	13.00	9.50	16.00	13.00	9.50	15.50	12.50	10.00	16.50	13.50	10.00	16.00	13.00	10.00	15.00	12.50	10.00	14.50	11.50	10.00
ForeFront™ Air Handlers	GAF2	16.00	13.50	9.00	15.00	12.50	9.00	14.50	12.00	8.50	14.00	12.00	9.00									
	TAM4	14.50	12.00	8.50	14.50	12.00	9.00	14.00	11.50	8.50	14.50	12.00	9.50	14.00	11.00	9.00	14.50	12.00	9.50	14.50	11.50	9.00
	GAM5	15.00	12.50	9.00	15.00	12.50	9.00	15.00	12.50	9.00	15.00	12.50	9.00	15.00	12.50	9.00	15.00	12.00	9.00	14.00	11.50	9.00
	TAM9	16.00	13.00	9.50	16.00	13.50	9.50	16.00	13.00	9.00	16.00	13.00	10.00	15.00	12.50	9.50	15.00	12.00	9.50	14.00	11.50	9.00

For complete equipment / combination selections, installation instructions and warranty information, please refer to Product Data/Ratings and/or Installers Guides and Limited Warranty Handbooks.

Split System Heat Pumps Summary of System Ratings

IMPORTANT:

This table is intended as an at-a-glance overview. See AHRI for complete and up-to-date indoor and outdoor system ratings by model. Not all matches will attain ratings shown below.

Model Not Offered		Gold 17 - Two Stage 17 SEER Heat Pump and Air Handler Ratings Summary (up to 17 SEER / 13.5 EER / 9.5 HSPF)																				
Gold 17-2 Stage		1.5 Ton			2 Ton			2.5 Ton			3 Ton			3.5 Ton			4 Ton			5 Ton		
		SEER	EER	HSPF	SEER	EER	HSPF	SEER	EER	HSPF	SEER	EER	HSPF	SEER	EER	HSPF	SEER	EER	HSPF	SEER	EER	HSPF
TEM Air Handlers	TEM6/8				17.00	12.50	8.50				17.00	12.50	9.60				17.00	12.50	9.60	15.00	12.00	9.60
ForeFront™ Air Handlers	GAM5				16.00	12.50	9.00				16.00	12.50	9.00				16.00	12.00	9.00	15.00	11.00	9.00
	TAM7				17.00	13.00	8.50				17.00	13.00	9.00				17.00	13.00	9.50	16.00	12.50	8.50
	TAM9				17.25	13.50	9.50				17.75	13.00	9.00				17.25	12.50	9.00	16.25	12.00	9.00

Platinum 18 AccuComfort™		Platinum 18 - SEER AccuComfort™ Variable Speed Heat Pump and Air Handler Ratings Summary (up to 18 SEER / 13.5 EER / 10.0 HSPF)																				
Platinum 18 AccuComfort™		1.5 Ton			2 Ton			2.5 Ton			3 Ton			3.5 Ton			4 Ton			5 Ton		
		SEER	EER	HSPF	SEER	EER	HSPF	SEER	EER	HSPF	SEER	EER	HSPF	SEER	EER	HSPF	SEER	EER	HSPF	SEER	EER	HSPF
ForeFront™ Air Handlers	TAM9				18.00	13.00	10.00				18.00	13.00	10.00				18.00	12.50	10.00	18.00	12.50	10.00

Platinum 19 AccuComfort™		Platinum 19 - SEER AccuComfort™ Variable Speed Heat Pump and Air Handler Ratings Summary (up to 19.5 SEER / 13.0 EER / 11.5 HSPF)																				
Platinum 19 AccuComfort™		1.5 Ton			2 Ton			2.5 Ton			3 Ton			3.5 Ton			4 Ton			5 Ton		
		SEER	EER	HSPF	SEER	EER	HSPF	SEER	EER	HSPF	SEER	EER	HSPF	SEER	EER	HSPF	SEER	EER	HSPF	SEER	EER	HSPF
TEM Air Handlers	TEM8				19.50	13.00	11.00				18.00	12.50	10.50				19.00	12.50	11.00	18.00	10.50	10.75
ForeFront™ Air Handlers	TAM9				19.50	13.00	11.50				17.75	12.50	11.00				19.00	11.50	11.50	19.00	10.50	11.00

Platinum 20 AccuComfort™		Platinum 20 - SEER AccuComfort™ Variable Speed Heat Pump and Air Handler Ratings Summary (up to 21.0 SEER / 13.50 EER / 10.0 HSPF)																				
Platinum 20 AccuComfort™		1.5 Ton			2 Ton			2.5 Ton			3 Ton			3.5 Ton			4 Ton			5 Ton		
		SEER	EER	HSPF	SEER	EER	HSPF	SEER	EER	HSPF	SEER	EER	HSPF	SEER	EER	HSPF	SEER	EER	HSPF	SEER	EER	HSPF
ForeFront™ Air Handlers	TAM9				19.25	13.75	10.00				21.00	13.50	10.00				19.25	12.50	10.00	19.00	12.70	10.00

Split System Heat Pumps

AccuComfort™ Variable Speed Heat Pumps Single Phase – 2-5 Tons



Platinum 20
(Variable Speed)

Table SH-3-A - Platinum 20 R-410A Split System Variable Speed Heat Pump (25–100% capacity)—with AccuLink™ ②

Model Number	Power Supply	Nom. Cap Cooling (BTUH)	Uncrated Dimensions(in.)			Shipping Weight (lbs.)	Sound** Rating		MCA*	Max. Fuse*	Line Size (in)	
			H	W	D		(Cool)	(Heat)			OD Gas	OD Liq.
4A6V0024A1000C	208/230/1/60	24,200	41	33	30	216	54/65	60/69	17	25	5/8	3/8
4A6V0036A1000C	208/230/1/60	35,000	41	37	34	254	59/70	60/72	26	40	3/4	3/8
4A6V0048A1000C	208/230/1/60	47,000	41	37	34	266	61/74	62/76	29	45	7/8	3/8
4A6V0060A1000C	208/230/1/60	54,500	45	37	34	276	57/73	61/74	37	50	1 1/8	3/8



Platinum 19
(Variable Speed)

Table SH-3-B - Platinum 19 R-410A Side Discharge Variable Speed Heat Pump (50-100% capacity)—with AccuLink™ ②

Model Number	Power Supply	Nom. Cap Cooling (BTUH)	Uncrated Dimensions(in.)			Shipping Weight (lbs.)	Sound** Rating		MCA*	Max. Fuse*	Line Size (in)	
			H	W	D		(Cool)	(Heat)			OD Gas	OD Liq.
4A6L9024A1000A①	208/230/1/60	23,600	37	47	18	229	50	49	19.1	25	5/8	3/8
4A6L9036A1000A①	208/230/1/60	35,600	37	47	18	250	48	49	26.9	30	3/4	3/8
4A6L9048A1000A①	208/230/1/60	47,000	43	47	18	269	54	52	31.8	35	7/8	3/8
4A6L9060A1000A①	208/230/1/60	58,600	43	47	18	269	56	57	36.1	40	7/8	3/8



Platinum 18
(Variable Speed)

Table SH-3-C - Platinum 18 R-410A Split System Variable Speed Heat Pump (25–100% capacity)—with AccuLink™ ②

Model Number	Power Supply	Nom. Cap Cooling (BTUH)	Uncrated Dimensions(in.)			Shipping Weight (lbs.)	Sound** Rating		MCA*	Max. Fuse*	Line Size (in)	
			H	W	D		(Cool)	(Heat)			OD Gas	OD Liq.
4A6V8024A1000B	208/230/1/60	23,800	41	33	30	216	54/65	60/69	17	25	5/8	3/8
4A6V8036A1000B	208/230/1/60	35,000	41	33	30	229	56/70	60/74	25	35	3/4	3/8
4A6V8037A1000B	208/230/1/60	35,000	41	37	34	254	56/70	60/74	26	40	3/4	3/8
4A6V8048A1000B	208/230/1/60	47,000	41	37	34	259	61/74	62/76	28	40	7/8	3/8
4A6V8049A1000B	208/230/1/60	47,000	41	37	34	266	61/74	62/76	29	45	7/8	3/8
4A6V8060A1000B	208/230/1/60	54,000	45	37	34	276	57/73	61/74	37	50	1 1/8	3/8

① For coastal applications where units are installed within one (1) mile of salt water, epoxy coated models are available for order. Model numbers with "COT" in the eleventh (11) through thirteenth (13) digits represent an epoxy coated coil. Example: 4A6L9036A1COTA. These models have an 8 week lead time after order.

② Must use ACONT850, AZONE950 or AZON1050 control.

* Information subject to change. Please confirm with current Product Data/Service Facts for current factory production.

** Rated in accordance with AHRI Standard 275

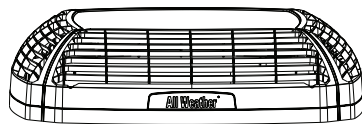

ALL WEATHER™ TOP ACCESSORY

BAYAWGR0003 - Fits base sizes 33"x30" (WxD)

BAYAWGR0004 - Fits base sizes 37"x34" (WxD)

AccuComfort™ Variable Speed Heat Pump Single Phase - 2-5 Tons

Table SH-4-A — Features

	Platinum 20 (4A6V0)	Platinum 19 (4A6L9)	Platinum 18 (4A6V8)
• SEER up to	21.00	19.50	18.00
• HSPF up to	10.00	12.00	10.00
• Duration™ compressor	1	1	1
• Number of stages	Variable	Variable	Variable
• Comfort-R™ mode approved	✓	✓	✓
• AccuLink™ system	✓	✓	✓
• DuraBase™ base, fast complete drain, weatherproof	✓	—	✓
• Easy-Sess™ cabinet, service access & refrigerant connections with full coil protection	✓	—	✓
• Spine Fin™ coil	✓	—	✓
• Compressor sound enclosure	✓	✓	✓
• Compressor sump heat	✓	✓	✓
• Factory supplied charge	R-410A	R-410A	R-410A
• Glossy corrosion resistant finish	✓	✓	✓
• High pressure switch	✓	✓	✓
• Low pressure protection	✓	✓	✓
• Internal high / low pressure & temperature protection	✓	✓	✓
• Liquid line filter drier - factory installed or factory supplied for field install	✓	✓	✓
• Seacoast shield - factory installed	✓	—	—
• Spinnaker gray cabinet	✓	✓	✓
• 10-year limited warranty on compressor, outdoor coil & all other functional parts	—	✓	—
• 12-year limited warranty on compressor, 10-year on outdoor coil & all other functional parts	✓	—	✓
• Extended warranties available	✓	✓	✓

Table SH-4-B — Optional Accessories

Model Number	Description	Shipping Weight			
BAYECMT023	Extreme Conditions Mounting Kit (Base 2/3)	2	2	—	024-036
BAYECMT004	Extreme Conditions Mounting Kit (Base 4)	2	3-5	—	037-060
BAYISLT101	Rubber Isolators	1	✓	✓	✓
BAYLEGS007	Snow Legs - 7" High (Black)	1	✓	✓	✓
BAYLEGS004	Snow Legs - 4" High (Black)	1	✓	✓	✓
BAYVDTA003	Vertical Discharge Air Kit Base 3	10	2	—	—
BAYVDTA004	Vertical Discharge Air Kit Base 4	10	3-5	—	—
BAYSEAC001	Seacoast Kit	1	—	—	✓
BAYWIND103	Wind Baffle Kit	5	—	✓	—
BAYSDHG003A	Hail Guard Kit	5	—	2-3	—
BAYSDHG004A	Hail Guard Kit	5	—	4-5	—
PAI00309①	Heresite Spraypaint	1	✓	✓	✓
BRK05033②	Wall Mount Kit		✓	✓	✓
BAYAWGR0004	All Weather™ Top - Fits unit base size of (W x D) of 37" X 34"		036-060	—	037-060
BAYAWGR0003	All Weather™ Top - Fits unit base size of (W x D) of 33" X 30"		024	—	024-036

Comfort Controls — See Comfort Controls/Zone Sensors Section

① Used for additional seacoast corrosion protection. Refer to bulletin number UN-SVB11A-EN for application information.
 ② Available from Trane Parts.

Split System Heat Pumps

BUILT TO A HIGHER STANDARD[®]

American Standard[®]
HEATING & AIR CONDITIONING

Split System Heat Pumps Single Phase – 1½-5 Tons

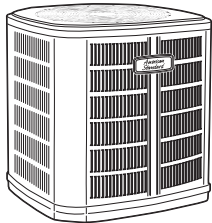

**Gold 17
(Two Stage)**

Table SH-5-A — Gold 17 R-410A Split System Two Stage Heat Pump (70/100% capacity)

Model Number	Power Supply	Nom. Cap. Cooling (BTUH)	Uncrated Dimensions(in.)			Shipping Weight (lbs.)	Sound** Rating	MCA*	Max. Fuse*	Line Size (in)	
			H	W	D					OD Gas	OD Liq.
4A6H7024A1000D	208/230/1/60	24,000	41	37	34	272	72	15	25	5/8	3/8
4A6H7036B1000D	208/230/1/60	36,000	41	37	34	274	72	20	35	3/4	3/8
4A6H7048A1000D	208/230/1/60	48,000	45	37	34	329	73	28	45	7/8	3/8
4A6H7060A1000D	208/230/1/60	60,000	45	37	34	330	74	41	60	1 1/8	3/8

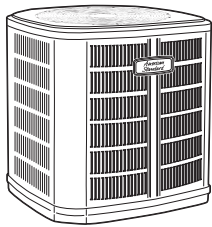

**Silver 16
(Single Stage)**

Table SH-5-B — Silver 16 R-410A Split System Single Stage Heat Pump

Model Number	Power Supply	Nom. Cap. Cooling (BTUH)	Uncrated Dimensions(in.)			Shipping Weight (lbs.)	Sound** Rating	MCA*	Max. Fuse*	Line Size (in)	
			H	W	D					OD Gas	OD Liq.
4A6H6018H1000A	208/230/1/60	18,800	33	33	30	208	74	12	20	3/4	3/8
4A6H6024H1000A	208/230/1/60	24,200	33	33	30	208	71	14	25	3/4	3/8
4A6H6030H1000A	208/230/1/60	28,600	37	37	34	245	70	17	25	3/4	3/8
4A6H6036H1000A	208/230/1/60	34,800	37	37	34	246	70	18	30	7/8	3/8
4A6H6042H1000A	208/230/1/60	41,000	45	37	34	277	72	22	35	7/8	3/8
4A6H6048H1000A	208/230/1/60	47,000	45	37	34	300	72	26	40	7/8	3/8
4A6H6060H1000A	208/230/1/60	55,000	45	37	34	301	72	31	50	1 1/8	3/8

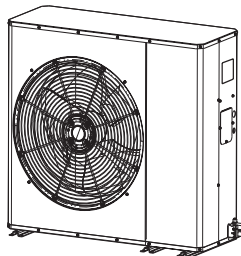

**Silver 16
(Single Stage)**

Table SH-5-C — Silver 16 R-410A SideDischarge Single Stage Heat Pump

Model Number	Power Supply	Nom. Cap. Cooling (BTUH)	Uncrated Dimensions(in.)			Shipping Weight (lbs.)	Sound** Rating	MCA*	Max. Fuse*	Line Size (in)	
			H	W	D					OD Gas	OD Liq.
4A6L6018A1000A①	208/230/1/60	19,000	30	40	15	186	69	12	20	3/4	3/8
4A6L6024A1000A①	208/230/1/60	24,000	30	40	15	186	69	13	20	3/4	3/8
4A6L6030A1000A①	208/230/1/60	29,000	36	47	18	222	70	13	20	3/4	3/8
4A6L6036A1000A①	208/230/1/60	36,000	36	47	18	225	71	19	30	7/8	3/8
4A6L6042A1000A①	208/230/1/60	42,000	36	47	18	244	71	25	40	7/8	3/8
4A6L6048A1000A①	208/230/1/60	48,000	42	47	18	266	74	26	45	7/8	3/8
4A6L6060A1000A①	208/230/1/60	56,000	42	47	18	267	74	32	50	7/8	3/8

① For coastal applications where units are installed within one (1) mile of salt water, epoxy coated models are available for order. Model numbers with "COT" in the eleventh (11) through thirteenth (13) digits represent an epoxy coated coil. Example: 4A6L6036A1COTA. These models have an 8 week lead time after order.

* Information subject to change. Please confirm with current Product Data/Service Facts for current factory production.

** Rated in accordance with AHRI Standard 270-2008 (Min/Max when applicable).

For complete equipment / combination selections, installation instructions and warranty information, please refer to Product Data/Ratings and/or Installers Guides and Limited Warranty Handbooks.

Split System Heat Pumps Single Phase – 1½-5 Tons

Table SH-6-A — Features

	Gold 17 (4A6H7)	Silver 16 (4A6H6)	Silver 16 (4A6L6)
• SEER up to.....	17.50	17.00	17.00
• HSPF up to.....	9.60	9.60	10.00
• Duration™ compressor.....	✓	✓	✓
• Number of stages.....	2	1	1
• Comfort-R™ mode approved.....	✓	✓	✓
• DuraBase™ base, fast complete drain, weatherproof.....	✓	✓	—
• Easy-Sess™ cabinet, service access & refrigerant connections with full coil protection.....	✓	✓	—
• Spine Fin™ coil.....	✓	✓	—
• Copper Tube Aluminum Fin coil.....	—	—	✓
• Electronic Expansion Valve (EEV).....	✓	—	—
• Compressor sump heat - factory installed.....	✓	—	—
• Factory supplied charge	R-410A	R-410A	R-410A
• Glossy corrosion resistant finish.....	✓	✓	✓
• High pressure switch.....	✓	✓	✓
• Low pressure switch.....	✓	✓	✓
• Liquid line filter drier - factory supplied for field install.....	✓	✓	✓
• Seacoast shield - factory installed.....	✓	—	—
• Spinnaker gray cabinet.....	✓	✓	✓
• 12-year limited warranty on compressor, 10-year on outdoor coil & all other functional parts	✓	—	—
• 10-year limited warranty on compressor, outdoor coil & all other functional parts	—	✓	✓
• Extended warranties available	✓	✓	✓

Table SH-6-B — Optional Accessories

Model Number	Description	Shipping Weight			
AY28X084.....	Evaporator Defrost Control	1.....	✓	✓	✓
BAYCCHT301RES	Crankcase Heater Kit (Scroll).....	1.....	—	3½-5	3½-5
BAYCCHT302RES	Crankcase Heater Kit (Scroll).....	1.....	—	1½-3	1½-3
BAYECMT023	Extreme Conditions Mounting Kit (Base 2/3).....	2.....	—	1½-2	—
BAYECMT004	Extreme Conditions Mounting Kit (Base 4).....	2.....	✓	2½-5	—
BAYISLT101	Rubber Isolators.....	1.....	✓	✓	✓
BAYKSKT263	Start kit (Scroll)	1.....	2-3	✓	2½-5
BAYKSKT266	Start kit (Scroll)	1.....	4-5	—	—
BAYLEGS007	Snow Legs - 7" High (Black)	1.....	✓	✓	✓
BAYLEGS004	Snow Legs - 4" High (Black)	1.....	✓	✓	✓
BAYLOAM107A.....	Low Ambient Kit	1.....	✓	✓	✓
TAYASCT501A①②	Anti-Short Cycle Timer	2.....	✓	✓	—
BAYSDEN003.....	Small Scroll Compressor Enclosures.....	8.....	2-3	1½-3	1½-3
BAYSDEN004.....	Large Scroll Compressor Enclosures	8.....	4-5	3½-5	3½-5
BAYSEAC001.....	Seacoast Kit.....	1.....	✓	✓	—
BAYSDHG001A.....	Hail Guard Kit.....	5.....	—	—	1½-2
BAYSDHG003A.....	Hail Guard Kit.....	5.....	—	—	2½-3½
BAYSDHG004A.....	Hail Guard Kit.....	5.....	—	—	4-5
BAYWIND102.....	Wind Baffle.....	—.....	—	—	1½-2
BAYWIND103.....	Wind Baffle.....	—.....	—	—	2½-5
AAYSVPANL3343AA	Service Valve Panel Cover Kit	2.....	2-3	1½-2	—
AAYSVPANL0044AA	Service Valve Panel Cover Kit	2.....	4-5	2½-3	—
AAYSVPANL0046AA	Service Valve Panel Cover Kit	2.....	—	3½-5	—
PAI00309③.....	Heresite Spraypaint.....	1.....	✓	✓	✓
BRK05033④	Wall Mount Kit	—.....	—	—	✓
BAYAWGR0004.....	All Weather™ Top - Fits unit base size of (W x D) of 37" X 34"	—.....	✓	030-060	—
BAYAWGR0003.....	All Weather™ Top - Fits unit base size of (W x D) of 33" X 30".....	—.....	—	018-024	—

Comfort Controls — See Comfort Controls/Zone Sensors Section

- ① Do not use with programmable thermostats.
- ② Activated on Power Off.
- ③ Used for additional seacoast corrosion protection. Refer to bulletin number UN-SVB11A-EN for application information.
- ④ Available from Trane Parts.

Split System Heat Pumps

Split System Heat Pumps Single Phase – 1½-5 Tons

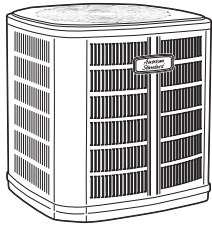

**Silver 15
(Single Stage)**

Table SH-7-A — Silver 15 R-410A Split System Single Stage Heat Pump

Model Number	Power Supply	Nom. Cap. Cooling (BTUH)	Uncrated Dimensions(in.)			Shipping Weight (lbs.)	Sound** Rating	MCA*	Max. Fuse*	Line Size (in)	
			H	W	D					OD Gas	OD Liq.
4A6H5018H1000A	208/230/1/60	18,600	29	29	26	161	73	12	20	¾	⅜
4A6H5019H1000A	208/230/1/60	18,700	33	33	30	196	74	12	20	¾	⅜
4A6H5024H1000A	208/230/1/60	24,600	33	33	30	208	71	14	25	¾	⅜
4A6H5030H1000A	208/230/1/60	29,800	29	37	34	248	72	17	25	¾	⅜
4A6H5036H1000A	208/230/1/60	36,000	45	37	34	246	70	18	30	⅞	⅜
4A6H5042H1000A	208/230/1/60	41,500	45	37	34	277	72	22	35	⅞	⅜
4A6H5048H1000A	208/230/1/60	48,000	45	37	34	300	72	24	40	⅞	⅜
4A6H5060H1000A	208/230/1/60	57,500	45	37	34	301	72	32	50	1⅛	⅜

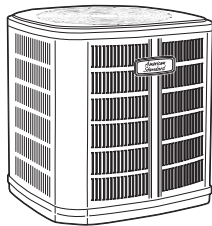

**Silver 14
(Single Stage)**

Table SH-7-B — Silver 14 R-410A Split System Single Stage Heat Pump

Model Number	Power Supply	Nom. Cap. Cooling (BTUH)	Uncrated Dimensions(in.)			Shipping Weight (lbs.)	Sound** Rating	MCA*	Max. Fuse*	Line Size (in)	
			H	W	D					OD Gas	OD Liq.
4A6H4018G1000A	208/230/1/60	18,600	29	29	26	161	73	12	20	¾	⅜
4A6H4024G1000A	208/230/1/60	24,400	29	33	30	191	71	14	25	¾	⅜
4A6H4030G1000A	208/230/1/60	29,000	29	37	34	248	72	17	25	¾	⅜
4A6H4036G1000A	208/230/1/60	34,000	29	37	34	248	76	19	30	⅞	⅜
4A6H4042G1000A	208/230/1/60	41,500	29	37	34	248	72	25	40	⅞	⅜
4A6H4048G1000A	208/230/1/60	48,500	33	37	34	300	72	25	45	⅞	⅜
4A6H4060G1000A	208/230/1/60	58,000	45	37	34	315	72	32	50	1⅛	⅜

* Information subject to change. Please confirm with current Product Data/Service Facts for current factory production.

** Rated in accordance with AHRI Standard 270-2008.

Split System Heat Pumps Single Phase – 1½-5 Tons

Table SH-8-A — Features	Silver 15 (4A6H5)	Silver 14 (4A6H4)
• SEER up to.....	15.75	14.50
• HSPF up to.....	9.50	8.50
• Duration™ compressor.....	✓	✓
• Comfort-R™ mode approved.....	✓	✓
• DuraBase™ base, fast complete drain, weatherproof.....	✓	✓
• Easy-Sess™ cabinet, service access & refrigerant connections with full coil protection.....	✓	✓
• Spine Fin™ coil.....	✓	✓
• Factory supplied charge	R-410A	R-410A
• Glossy corrosion resistant finish.....	✓	✓
• High pressure switch.....	✓	✓
• Low pressure switch.....	—	✓
• Internal high / low pressure & temperature protection.....	✓	✓
• Liquid line filter drier - factory supplied for field install.....	✓	✓
• Spinnaker gray cabinet.....	✓	✓
• 10-year limited warranty on compressor, outdoor coil & all other functional parts	✓	✓
• Extended warranties available	✓	✓

Table SH-8-B — Optional Accessories

Model Number	Description	Shipping Weight		
AY28X084.....	Evaporator Defrost Control	1.....	✓	✓
BAYCCHT301RES.....	Crankcase Heater Kit (Scroll).....	1.....	5	3½-5
BAYCCHT302RES.....	Crankcase Heater Kit (Scroll).....	1.....	1½-3	1½-3
BAYECMT023.....	Extreme Conditions Mounting Kit (Base 2/3).....	2.....	1½-2	1½-2
BAYECMT004.....	Extreme Conditions Mounting Kit (Base 4).....	2.....	2½-5	2½-5
BAYISLT101.....	Rubber Isolators.....	1.....	✓	✓
BAYKSKT263.....	Start kit (Scroll)	1.....	✓	✓
BAYLEGS007.....	Snow Legs - 7" High (Black)	1.....	✓	✓
BAYLEGS004.....	Snow legs - 4" High (Black)	1.....	✓	✓
BAYLOAM107A.....	Low Ambient Kit	1.....	✓	✓
TAYASCT501A①②.....	Anti-Short Cycle Timer	2.....	✓	✓
BAYSDEN003.....	Small Scroll Compressor Enclosures.....	8.....	1½-3	1½-3
BAYSDEN004.....	Large Scroll Compressor Enclosures	8.....	4-5	3½-5
BAYSEAC001.....	Seacoast Kit	1.....	✓	✓
AAYSVPANL0022AA.....	Service Valve Panel Cover Kit	2.....	1½	1½
AAYSVPANL0032AA.....	Service Valve Panel Cover Kit	2.....	2½	2-3½
AAYSVPANL3343AA.....	Service Valve Panel Cover Kit	2.....	019,024	4
AAYSVPANL0044AA.....	Service Valve Panel Cover Kit	2.....	3	—
AAYSVPANL0046AA.....	Service Valve Panel Cover Kit	2.....	5	5
PAI00309③.....	Heresite Spraypaint.....	1.....	✓	✓
BAYAWGR0004.....	All Weather™ Top - Fits unit base size of (W x D) of 37" X 34".....		030-060	030-060
BAYAWGR0003.....	All Weather™ Top - Fits unit base size of (W x D) of 33" X 30".....		019-024	024

Comfort Controls — See Comfort Controls/Zone Sensors Section

- ① Do not use with programmable thermostats.
- ② Activated on Power Off.
- ③ Used for additional seacoast corrosion protection. Refer to bulletin number UN-SVB11A-EN for application information.

Split System Heat Pumps

Split System Heat Pumps Three Phase

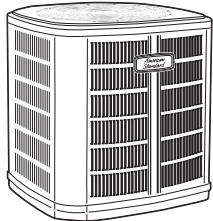

**Gold 17
(Two Stage)
3-Phase**

Table SH-9-A — Gold 17 3-Phase R-410A Split System Two Stage Heat Pump - Three Phase

Model Number	Power Supply	Nom. Cap. Cooling (BTUH)	Uncrated Dimensions (in.)			Shipping Weight (lbs.)	Sound** Rating	MCA*	Max. Fuse*	Line Size (in)	
			H	W	D					OD Gas	OD Liq.
4A6C7036A3000A	208/230/3/60	36,000	45	37	34	307	72	15	25	3/4	3/8
4A6C7048A3000A	208/230/3/60	46,500	45	37	34	323	73	18	30	7/8	3/8
4A6C7060A3000A	208/230/3/60	58,500	45	37	34	326	74	22	35	1 1/8	3/8
4A6C7036A4000A	460/3/60	36,000	45	37	34	307	72	8	15	3/4	3/8
4A6C7048A4000A	460/3/60	46,500	45	37	34	323	73	9	15	7/8	3/8
4A6C7060A4000A	460/3/60	58,500	45	37	34	326	74	10	15	1 1/8	3/8

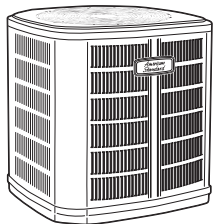

**Silver 14
(Single Stage)
3-Phase**

Table SH-9-B — Silver 14 3-Phase R-410A Split System Single Stage Heat Pump - Three Phase

Model Number	Power Supply	Nom. Cap. Cooling (BTUH)	Uncrated Dimensions (in.)			Shipping Weight (lbs.)	Sound** Rating	MCA*	Max. Fuse*	Line Size (in)	
			H	W	D					OD Gas	OD Liq.
4A6C4036A3000A	208/230/3/60	36,800	29	37	34	248	75	13	20	7/8	3/8
4A6C4042A3000A	208/230/3/60	41,500	29	37	34	248	74	18	20	7/8	3/8
4A6C4048A3000A	208/230/3/60	47,500	33	37	34	300	74	18	30	7/8	3/8
4A6C4060A3000A	208/230/3/60	55,500	45	37	34	301	74	21	35	1 1/8	3/8
4A6C4036A4000A	460/3/60	35,600	29	37	34	248	75	6	15	7/8	3/8
4A6C4042A4000A	460/3/60	42,000	29	37	34	248	74	8	15	7/8	3/8
4A6C4048A4000A	460/3/60	47,500	33	37	34	300	74	8	15	7/8	3/8
4A6C4060A4000A	460/3/60	55,000	45	37	34	301	74	9	15	1 1/8	3/8

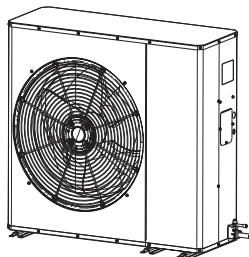

**Silver 16
(Single Stage)**

Table SH-9-C — Silver 16 R-410A Side Discharge Single Stage Heat Pump — Three Phase

Model Number	Power Supply	Nom. Cap. Cooling (BTUH)	Uncrated Dimensions (in.)			Shipping Weight (lbs.)	Sound** Rating	MCA*	Max. Fuse*	Line Size (in)	
			H	W	D					OD Gas	OD Liq.
4A6S6036A3000A ^①	208/230/3/60	36000	36	47	18	225	73	11	15	7/8	3/8
4A6S6048A3000A ^①	208/230/3/60	48000	42	47	18	266	76	18	30	7/8	3/8
4A6S6060A3000A ^①	208/230/3/60	56000	42	47	18	267	76	16	25	7/8	3/8
4A6S6036A4000A ^①	460/3/60	36000	36	47	18	225	73	5	15	7/8	3/8
4A6S6048A4000A ^①	460/3/60	48000	42	47	18	266	76	8	15	7/8	3/8
4A6S6060A4000A ^①	460/3/60	56000	42	47	18	267	76	9	15	7/8	3/8

① For coastal applications where units are installed within one (1) mile of salt water, epoxy coated models are available for order. Model numbers with "COT" in the eleventh (11) through thirteenth (13) digits represent an epoxy coated coil. Example: 4A6S6036A3COTA. These models have an 8 week lead time after order.

* Information subject to change. Please confirm with current Product Data/Service Facts for current factory production.

** Rated in accordance with AHRI Standard 270-2008 (Min/Max when applicable).

Split System Heat Pumps

Split System Heat Pumps Single Phase and Three Phase

Table SH-10-A — Features

	Gold 17 (4A6C7)	Silver 14 (4A6C4)	Silver 16 (4A6S6)
• SEER up to	17.5	15.5	16.0
• HSPF up to	9.60	9.50	10.0
• Duration™ compressor	—	—	✓
• Comfort-R™ mode approved	✓	✓	✓
• DuraBase™ base, fast complete drain, weatherproof	✓	✓	—
• Easy-Sess™ cabinet, service access & refrigerant connections with full coil protection	✓	✓	—
• Spine Fin™ coil	✓	✓	—
• Copper/Aluminum coil	—	—	✓
• Compressor sump heat - factory installed	✓	✓	✓
• Refrigerant	R-410A	R-410A	R-410A
• Glossy corrosion resistant finish	✓	✓	✓
• High pressure switch	✓	✓	✓
• Low pressure switch	✓	✓	✓
• Internal high / low pressure & temperature protection	—	—	✓
• Liquid line filter drier - factory supplied	✓	✓	✓
• Tarpaulin gray cabinet	—	—	✓
• 5-year basic limited warranty on compressor, 1-year on outdoor coil & all other functional parts (Commercial Use)	✓	✓	✓
• 10-year limited warranty on compressor, outdoor coil & all other functional parts (Residential Use)	—	—	✓
• Extended warranties available	✓	✓	✓

Table SH-10-B — Optional Accessories

Model Number	Description	Shipping Weight			
AY28X084.....	Evaporator Defrost Control HP	1.....	✓	✓	✓
BAYECMT004	Extreme Conditions Mounting Kit (Base 4)	2.....	3-5	3-5	—
BAYISLT101	Rubber Isolators	1.....	✓	✓	✓
BAYKSKT266	Start Kit (Scroll)	1.....	—	—	✓
BAYLEGS007	Snow Legs - 7" High (Black)	1.....	✓	✓	✓
BAYLEGS004	Snow Legs - 4" High (Black)	1.....	✓	✓	✓
BAYLOAM107A.....	Low Ambient Kit	1.....	✓	✓	—
BAYSDEN003	Small Scroll Compressor Enclosures.....	8.....	3	✓	3
BAYSDEN004	Large Scroll Compressor Enclosures	8.....	4,5	3½-5	4,5
BAYSEAC001	Seacoast Kit	1.....	✓	✓	—
TAYASCT501A ^{①②}	Anti-short cycle timer.....	2.....	✓	4	—
PAI00309 ^③	Heresite Spraypaint.....	1.....	✓	—	✓
AAYSVPANL0032AA....	Service Valve Panel Cover Kit.....	2.....	—	3-3½	—
AAYSVPANL0044AA....	Service Valve Panel Cover Kit.....	2.....	3-5	—	—
ATAYSVPANL0046AA ..	Service Valve Panel Cover Kit.....	2.....	—	5	—
AAYSVPANL3343AA....	Service Valve Panel Cover Kit.....	2.....	—	4	—
BRK05033 ^④	Wall Mount Kit	—	—	✓
BAYTWGR0004	All Weather™ Top - Fits unit base size of (W x D) of 37" X 34".....	✓	✓	—

Comfort Controls — See Comfort Controls/Zone Sensors Section

- ① Do not use with programmable thermostats.
- ② Activated on Power Off.
- ③ Used for additional seacoast corrosion protection. Refer to bulletin number UN-SVB11A-EN for application information.
- ④ Available from Trane Parts.

Split System Heat Pumps

Multi-position Air Handler

* Note: No internal modifications required for any position.
 ① Badge rotation will keep brand in correct position

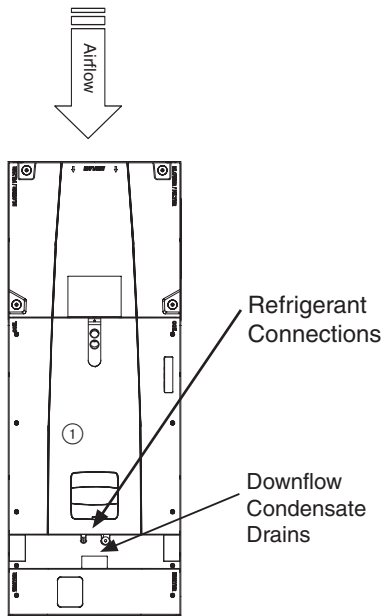

Vertical Downflow*

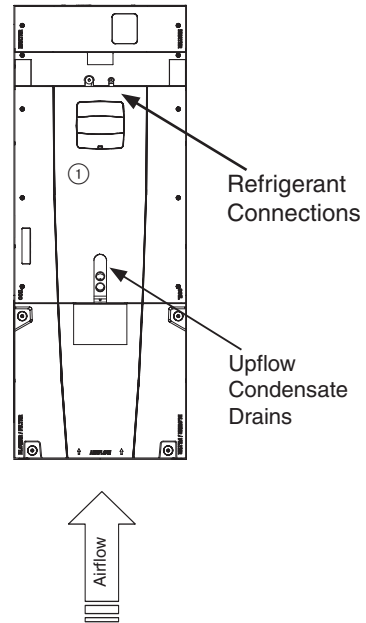

Vertical Upflow*
(as shipped)

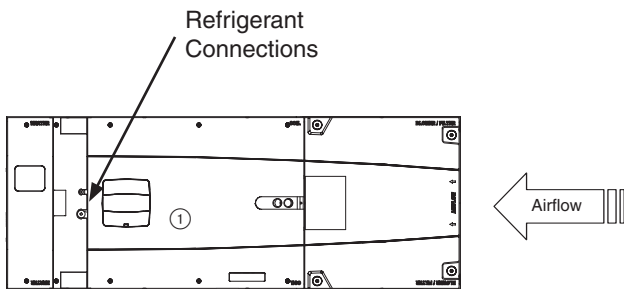

Horizontal Left*

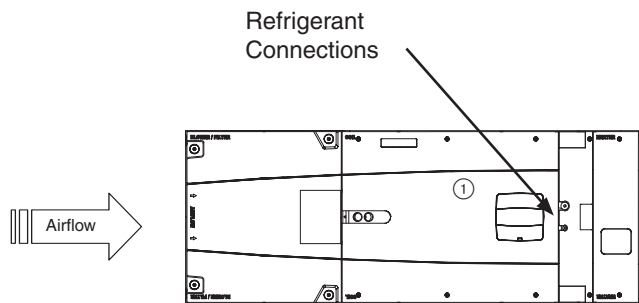

Horizontal Right*

For complete equipment / combination selections, installation instructions and warranty information, please refer to Product Data/Ratings and/or Installers Guides and Limited Warranty Handbooks.

BUILT TO A HIGHER STANDARD™

American Standard®

HEATING & AIR CONDITIONING

Features and Benefits

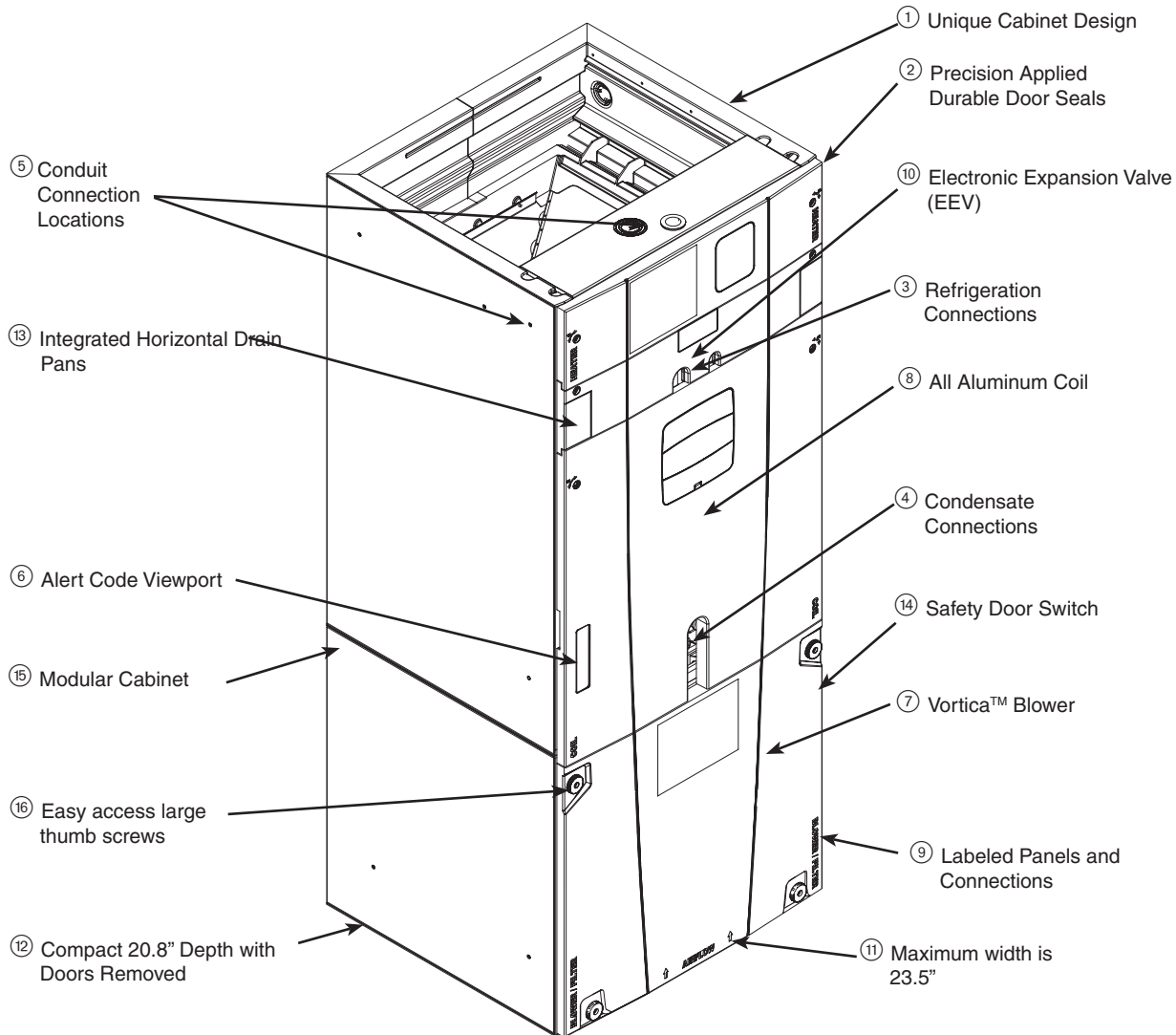

- ① Unique Cabinet Design
 - Double wall foamed cabinet system
 - Waterproof Cabinet Design (No Thermal Breakage)
 - \geq R-4.2 Insulating Value (Avg. Insulating Value R-8.2)
 - Composite Cabinet Doors
 - Sweat Eliminating Cabinet Design
 - Loose Fiber Eliminating Design
 - Smooth Cleanable Cabinet Design
- ② Precision Applied Durable Door Seals
- ③ Refrigeration Connections
- ④ Condensate Connections
- ⑤ Conduit Connection Locations - Dimples in cabinet mark Conduit Connection Locations for Left, Right, and Top
- ⑥ Alert Code Viewport
 - Alert Codes can be Viewed Without Door Removal
 - Control Protection Pocket
- ⑦ Vortica™ Blower
 - Polarized Plug Connections
 - Integrated Slide Deck for Easy Removal
- ⑧ All Aluminum Coil
 - Integrated Slide Deck for Easy Removal
 - Polarized Plug connections on Coil EEV
 - Patented Enhanced Coil Fin
- ⑨ Labeled Panels and Connections
- ⑩ Electronic Expansion Valve (EEV)
 - Low Ambient and Low Superheat Compressor Protection
 - Dual Refrigerant Compatible as Shipped
- ⑪ Maximum width is 23.5"
- ⑫ Compact 20.8" Depth with Doors Removed
- ⑬ Integrated Horizontal Drain Pans
- ⑭ Safety Door Switch - Fused 24V Power
- ⑮ Modular Cabinet
- ⑯ Easy access large thumb screws

For complete equipment / combination selections, installation instructions and warranty information, please refer to Product Data/Ratings and/or Installers Guides and Limited Warranty Handbooks.

BUILT TO A HIGHER STANDARD™

American Standard
HEATING & AIR CONDITIONING

Series 9 Variable Speed Multi-Position Air Handlers 2-5 Tons

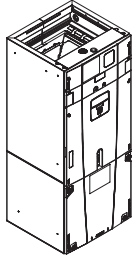

Table AH-3-A — AccuLink™ II or 24V Variable Speed R-410A with Smart Fan Options 200-230/1/60, Epoxy Coated Coil

Unit Model No.	Cooling Capacity (Btuh)	Dimensions (in.) H x W x D	Shipping Weight (lbs.)	Supply Opening	Return Opening	Filter Sizes	Line Size Gas	Line Size Liquid
TAM9A0A24V21DA	24000	49.9 x 17.5 x 21.8	126	14.5 x 14.35	14.5 x 17.15	16 x 20 x 1	3/4	3/8
TAM9A0B30V31DA	30000	55.7 x 21.3 x 21.8	150	18.4 x 14.35	18.4 x 17.15	20 x 20 x 1	3/4	3/8
TAM9A0C36V31DA	36000	56.9 x 23.5 x 21.8	157	20.5 x 14.35	20.5 x 17.15	22 x 20 x 1	7/8	3/8
TAM9A0C42V41DA	42000	56.9 x 23.5 x 21.8	162	20.5 x 14.35	20.5 x 17.15	22 x 20 x 1	7/8	3/8
TAM9A0C48V41DA	48000	61.7 x 23.5 x 21.8	174	20.5 x 14.35	20.5 x 17.15	22 x 20 x 1	7/8	3/8
TAM9A0C60V51DA	60000	61.7 x 23.5 x 21.8	175	20.5 x 14.35	20.5 x 17.15	22 x 20 x 1	7/8	3/8

Series 9 Variable Speed Multi-Position Air-Tite™ Air Handlers

Table AH-3-B — Features

	TAM9 2-5
• Unique cabinet design.....	✓
– 2% or less air leakage.....	✓
– Precision applied - durable door seals.....	✓
– Specially designed air seal around refrigerant, condensate and conduit connections.....	✓
– Double wall foamed cabinet system.....	✓
– ≥ R-4.2 insulating value (Avg. Insulating Value R-8.2).....	✓
– No loose fiber design.....	✓
– Smooth cleanable interior design.....	✓
– Sweat eliminating design.....	✓
– Composite cabinet doors.....	✓
– Water proof cabinet design.....	✓
– Integrated horizontal drain pans.....	✓
– Modular cabinet.....	✓
• Multi-position up/down flow horizontal left/right.....	✓
• Side return option (sold as accessory).....	✓
• Control board protection pocket built into cabinet wall.....	✓
• Alert port to view control board codes without door removal.....	✓
• ComfortLink™ II or 24 Volt control.....	✓
• Alert code notification.....	✓
• 5 button user interface and clear description of set up.....	✓
• Service diagnostic with alert reported at user interface.....	✓
• Low voltage terminal connection point.....	✓
• Vortica® blower with polarized plug connections and integrated slide deck for easy removal.....	✓
• Aluminum coil with integrated slide deck for easy removal and polarized plug connections on coil EEV.....	✓
• Patented enhanced coil fin.....	✓
• Epoxy coated coil.....	✓
• Electronic Expansion Valve (EEV) with low ambient and low superheat compressor protection.....	✓
• Dual refrigerant compatible as shipped.....	✓
• Slide in electric heaters with polarized plug connections (sold as accessory).....	✓
• Slide in hot water coils with polarized plug connections (sold as accessory).....	✓
• UVC light kit with safety switch and polarized plug connections (sold as accessory).....	✓
• Labeled panels and connections.....	✓
• Molded in 1" standard filter rail.....	✓
• Direct drive, variable speed ECM blower motor - Constant airflow ECM (electronically commutated motor).....	✓
• Soft start fan motor operation.....	✓
• Comfort R™ mode.....	✓
• Built in fan delay modes.....	✓
• Maximum width of 23.5".....	✓
• Compact 20.8" depth with doors removed.....	✓
• Fused 24v power.....	✓
• Safety door switch.....	✓
• 10-year limited warranty/parts/No Registration Required	✓
• 10-year limited warranty/coil/No Registration Required	✓

For complete equipment / combination selections, installation instructions and warranty information, please refer to Product Data/Ratings and/or Installers Guides and Limited Warranty Handbooks.

Series 9 Variable Speed Multi-Position Air-Tite™ Air Handlers

Table AH-4-A — Optional Accessories

Model Number	Description	Matches Cabinet Size(s) ^①	TAM9
BAYWAAA05SC1AA	Hydronic Heater, Slide In, 40,000 BTUH, Nominal ^③	A	✓
BAYWABB07SC1AA	Hydronic Heater, Slide In, 50,000 BTUH, Nominal ^③	B	✓
BAYWACC08SC1AA	Hydronic Heater, Slide In, 65,000 BTUH, Nominal ^③	C	✓
BAYWACC11SC1AA	Hydronic Heater, 100,000 BTUH, Nominal, External Top Mount, No Control ^③	C	✓
BAYWAKIT24VAC	Hydronic Heater Relay Kit	C	✓
BAYSUPFLGAA	Supply Duct Flange A	A	✓
BAYSUPFLGBA	Supply Duct Flange B	B	✓
BAYSUPFLGCA	Supply Duct Flange C	C	✓
BAYRETFLGAA	Return Duct Flange A	A	✓
BAYRETFLGBA	Return Duct Flange B	B	✓
BAYRETFLGCA	Return Duct Flange C	C	✓
BAYFLR1620A	Washable high velocity filter, 16" x 20" x 1" (10 filters)	A	✓
BAYFLR2020A	Washable high velocity filter, 20" x 20" x 1" (10 filters)	B	✓
BAYFLR2220A	Washable high velocity filter, 22" x 20" x 1" (10 filters)	C	✓
TASB175SB ^{②⑤}	Plenum Stand with Integrated Sound Baffle A	A	✓
TASB215SB ^{②⑤}	Plenum Stand with Integrated Sound Baffle B	B	✓
TASB235SB ^{②⑤}	Plenum Stand with Integrated Sound Baffle C	C	✓
MTISRKIT1620 ^②	Side Return Kit with 16"x20" Filter	A-C	✓
BAYSRKIT100	Side Return Kit	A-C	✓
BAYFRKIT175	Front Return Kit	A	✓
BAYFRKIT210	Front Return Kit	B	✓
BAYFRKIT235	Front Return Kit	C	✓
TASSBK175 ^{②④⑥}	Sound Baffle Kit 17.5" Cabinet	A	✓
TASSBK215 ^{②④⑥}	Sound Baffle Kit 21.5" Cabinet	B	✓
TASSBK235 ^{②④⑥}	Sound Baffle Kit 23.5" Cabinet	C	✓
BAYSPEKT200	Single Power Entry Kit		✓
TAYBASETAMA	Downflow Sub-Base Kit	A-C	✓
BAYICKSKIT01	Internal Condensate Switch Kit		✓
BAYHHKIT001	Horizontal Hanger Kit		✓
BAYUVCLK001	UV Lights		✓
BAYLVKIT100	Low Voltage Conduit Entry Kit		✓
BAYAHMIKIT001	Air handler Electronic Noise Kit used on Variable Speed Blower Motor		✓
BAYBAFKT175A ^⑦	Sound Baffle Kit 17.5" Cabinet	A	✓
BAYBAFKT215A ^⑦	Sound Baffle Kit 21.5" Cabinet	B	✓
BAYBAFKT235A ^⑦	Sound Baffle Kit 23.5" Cabinet	C	✓
BAYINSKT175A	Sound Insulation Kit 17.5" Cabinet	A	✓
BAYINSKT215A	Sound Insulation Kit 21.5" Cabinet	B	✓
BAYINSKT235A	Sound Insulation Kit 17.5" through 23.5" Cabinet	A-C	✓
BAYCNDPIP01A	3/4" PVC Threaded Pipe Kit with foam seal (10 kits)		✓

- ① A Cabinet is 17.5" wide, B Cabinet is 21.5" wide, C Cabinet is 23.5" wide.
- ② Contact your distributor for information.
- ③ ACONT900 Thermostat can not be used with Hydronic heating.
- ④ In return plenum applications, use TASSBK kits for sound reduction.
- ⑤ In open air applications, Plenum Stand with Sound Baffle provides sound reduction.
- ⑥ Mounts to TASB original plenum stands without integrated sound baffle.
- ⑦ Mounts inside air filter channel on air handler.

BUILT TO A HIGHER STANDARD™

American Standard
HEATING & AIR CONDITIONING

Series 4 Multi-Position Air Handlers Single Phase 1½-5 Tons

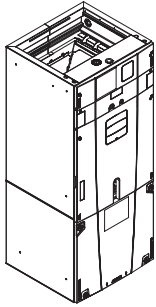

Table AH-5-A — Multi-Speed PSC Motor 200-230/1/60, Epoxy Coated Coil

Unit Model No.	Cooling Capacity (Btuh)	Dimensions (in.) H x W x D	Shipping Weight (lbs.)	Supply Opening	Return Opening	Filter Sizes	Line Size Gas	Line Size Liquid
TAM4A0A18S11ED	18000	49.9 x 17.5 x 21.8	123	14.5 x 14.35	14.5 x 17.15	16 x 20 x 1	¾	⅜
TAM4A0A24S21ED	24000	49.9 x 17.5 x 21.8	126	14.5 x 14.35	14.5 x 17.15	16 x 20 x 1	¾	⅜
TAM4A0A30S21ED	30000	49.9 x 17.5 x 21.8	127	14.5 x 14.35	14.5 x 17.15	16 x 20 x 1	7/8	⅜
TAM4A0A36S31ED	36000	49.9 x 17.5 x 21.8	130	14.5 x 14.35	14.5 x 17.15	16 x 20 x 1	7/8	⅜
TAM4A0B42S31ED	42000	55.7 x 21.3 x 21.8	144	18.4 x 14.35	18.4 x 17.15	20 x 20 x 1	7/8	⅜
TAM4A0C48S41ED	48000	56.9 x 23.5 x 21.8	155	20.5 x 14.35	20.5 x 17.15	20 x 20 x 1	7/8	⅜
TAM4A0C60S51ED①	60000	61.7 x 23.5 x 21.8	171	20.5 x 14.35	20.5 x 17.15	22 x 20 x 1	7/8	⅜

① High efficiency ECM motor.

Table AH-5-B — Features

Table AH-5-B — Features	TAM4 1 1/2-5
• Unique cabinet design.....	✓
– 2% or less air leakage.....	✓
– Precision applied - durable door seals.....	✓
– Specially designed air seal around refrigerant, condensate and conduit connections.....	✓
– Double wall foamed cabinet system.....	✓
– ≥ R-4.2 insulating value (Avg. Insulating Value R-8.2).....	✓
– No loose fiber design.....	✓
– Smooth cleanable interior design.....	✓
– Sweat eliminating design.....	✓
– Composite cabinet doors.....	✓
– Water proof cabinet design.....	✓
– Integrated horizontal drain pans.....	✓
– Modular cabinet.....	✓
• Multi-position up/down flow horizontal left/right.....	✓
• Side return option (sold as accessory).....	✓
• Alert code notification.....	✓
• Low voltage pigtail connections.....	✓
• Vortica® blower with polarized plug connections and integrated slide deck for easy removal.....	✓
• Aluminum coil with integrated slide deck for easy removal and polarized plug connections on coil EEV.....	✓
• Enhanced coil fin patented.....	✓
• Epoxy coated coil.....	✓
• Electronic Expansion Valve (EEV) with low ambient and low superheat compressor protection.....	✓
• Dual refrigerant compatible as shipped.....	✓
• Slide in electric heaters with polarized plug connections (sold as accessory).....	✓
• UVC light kit with safety switch and polarized plug connections (sold as accessory).....	✓
• Labeled panels and connections.....	✓
• Molded in 1" standard filter rail.....	✓
• PSC 3 speed motor.....	1½-4
• Direct drive, multi speed ECM blower motor - Constant torque ECM (electronically commutated motor).....	5
• Maximum width of 23.5".....	✓
• Compact 20.8" depth with doors removed.....	✓
• Fused 24v power.....	✓
• Safety door switch.....	✓
• 10-year limited warranty/parts/No Registration Required.....	✓
• 10-year limited warranty/coil/No Registration Required.....	✓

For complete equipment / combination selections, installation instructions and warranty information, please refer to Product Data/Ratings and/or Installers Guides and Limited Warranty Handbooks.

Series 4 Multi-Position Air Handlers Single Phase 1½-5 Tons

Table AH-6-A — Optional Accessories

Model Number	Description	Matches Cabinet Size(s) ^①	TAM4
BAYSUPFLGAA	Supply Duct Flange A	A	✓
BAYSUPFLGBA	Supply Duct Flange B	B	✓
BAYSUPFLGCA	Supply Duct Flange C	C	✓
BAYRETF LGAA	Return Duct Flange A	A	✓
BAYRETF LGBA	Return Duct Flange B	B	✓
BAYRETF LGCA	Return Duct Flange C	C	✓
BAYFLR1620A	Washable high velocity filter, 16" x 20" x 1" (10 filters)	A	✓
BAYFLR2020A	Washable high velocity filter, 20" x 20" x 1" (10 filters)	B	✓
BAYFLR2220A	Washable high velocity filter, 22" x 20" x 1" (10 filters)	C	✓
TASB175SB ^{②④}	Plenum Stand with Integrated Sound Baffle A	A	✓
TASB215SB ^{②④}	Plenum Stand with Integrated Sound Baffle B	B	✓
TASB235SB ^{②④}	Plenum Stand with Integrated Sound Baffle C	C	✓
MTISRKIT1620 ^②	Side Return Kit with 16"x20" Filter	A-C	✓
TASSBK175 ^{②③⑤}	Sound Baffle Kit 17.5" Cabinet	A	✓
TASSBK215 ^{②③⑤}	Sound Baffle Kit 21.5" Cabinet	B	✓
TASSBK235 ^{②③⑤}	Sound Baffle Kit 23.5" Cabinet	C	✓
BAYSPEKT200	Single Power Entry Kit		✓
BAYSRKIT100	Side Return Kit	A-C	✓
BAYFRKIT175	Front Return Kit	A	✓
BAYFRKIT210	Front Return Kit	B	✓
BAYFRKIT235	Front Return Kit	C	✓
BAYICSKIT01	Internal Condensate Switch Kit		✓
BAYHHKIT001	Horizontal Hanger Kit		✓
BAYUVCLK001	UVC Lights		✓
BAYLVKIT100A	Low Voltage Conduit Entry Kit		✓
BAYAHEMIKIT001	Air handler Electronic Noise Kit used on Variable Speed Blower Motor		✓
BAYBAFKT175A ^⑥	Sound Baffle Kit 17.5" Cabinet	A	✓
BAYBAFKT215A ^⑥	Sound Baffle Kit 21.5" Cabinet	B	✓
BAYBAFKT235A ^⑥	Sound Baffle Kit 23.5" Cabinet	C	✓
BAYINSKT175A	Sound Insulation Kit 17.5" Cabinet	A	✓
BAYINSKT215A	Sound Insulation Kit 21.5" Cabinet	B	✓
BAYINSKT235A	Sound Insulation Kit 17.5" through 23.5" Cabinet	A-C	✓
BAYCNDPIP01A	3/4" PVC Threaded Pipe Kit with foam seal (10 kits)		✓

① A Cabinet is 17.5" wide, B Cabinet is 21.5" wide, C Cabinet is 23.5" wide.
 ② Contact your distributor for information.
 ③ In return plenum applications, use TASSBK kits for sound reduction.
 ④ In open air applications, Plenum Stand with Sound Baffle provides sound reduction.
 ⑤ Mounts to TASB original plenum stands without integrated sound baffle.
 ⑥ Mounts inside air filter channel on air handler.

Series 5 Multi-Position Air Handlers Single Phase 1½-5 Tons

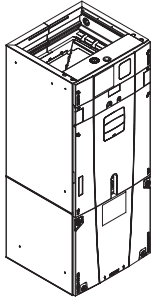

Table AH-7-A — Multi-Speed High Efficiency Motor 200-230/1/60, Epoxy Coated Coil

Unit Model No.	Cooling Capacity (Btu/h)	Dimensions (in.) H x W x D	Shipping Weight (lbs.)	Supply Opening	Return Opening	Filter Sizes	Line Size	
							Gas	Liquid
GAM5B0A18M11EA	18000	49.9 x 17.5 x 21.8	126	14.5 x 14.35	14.5 x 17.15	16 x 20 x 1	¾	⅜
GAM5B0A24M21EA	24000	49.9 x 17.5 x 21.8	126	14.5 x 14.35	14.5 x 17.15	16 x 20 x 1	¾	⅜
GAM5B0B30M21EA	30000	51.5 x 21.3 x 21.8	140	18.4 x 14.35	18.4 x 17.15	20 x 20 x 1	¾	⅜
GAM5B0B36M31EA	36000	55.7 x 21.3 x 21.8	150	18.4 x 14.35	18.4 x 17.15	20 x 20 x 1	7/8	⅜
GAM5B0C42M31EA	42000	56.9 x 23.5 x 21.8	163	20.5 x 14.35	20.5 x 17.15	22 x 20 x 1	7/8	⅜
GAM5B0C48M41EA	48000	61.7 x 23.5 x 21.8	176	20.5 x 14.35	20.5 x 17.15	22 x 20 x 1	7/8	⅜
GAM5B0C60M51EA	60000	61.7 x 23.5 x 21.8	180	20.5 x 14.35	20.5 x 17.15	22 x 20 x 1	7/8	⅜

Table AH-7-B — Features

	GAM5 1 1/2-5
• Unique cabinet design.....	✓
– 2% or less air leakage.....	✓
– Precision applied - durable door seals.....	✓
– Specially designed air seal around refrigerant, condensate and conduit connections.....	✓
– Double wall foamed cabinet system.....	✓
– ≥ R-4.2 insulating value (Avg. Insulating Value R-8.2).....	✓
– No loose fiber design.....	✓
– Smooth cleanable interior design.....	✓
– Sweat eliminating design.....	✓
– Composite cabinet doors.....	✓
– Water proof cabinet design.....	✓
– Integrated horizontal drain pans.....	✓
– Modular cabinet.....	✓
• Multi-position up/down flow horizontal left/right.....	✓
• Side return option (sold as accessory).....	✓
• Low voltage pigtail connections.....	✓
• Vortica® blower with polarized plug connections and integrated slide deck for easy removal.....	✓
• Aluminum coil with integrated slide deck for easy removal.....	✓
• Patented enhanced coil fin.....	✓
• Epoxy coated coil.....	✓
• R-410A TXV.....	✓
• Slide in electric heaters with polarized plug connections (sold as accessory).....	✓
• UVC light kit with safety switch and polarized plug connections (sold as accessory).....	✓
• Labeled panels and connections.....	✓
• Molded in 1" standard filter rail.....	✓
• Direct drive, multi speed ECM blower motor - Constant torque ECM (electronically commutated motor).....	✓
• Maximum width of 23.5".....	✓
• Compact 20.8" depth with doors removed.....	✓
• Fused 24v power.....	✓
• Safety door switch.....	✓
• 10-year limited warranty/parts/No Registration Required.....	✓
• 10-year limited warranty/coil/No Registration Required.....	✓

Series 5 Multi-Position Air Handlers Single Phase 1½-5 Tons

Table AH-8-A — Optional Accessories

Model Number	Description	Matches Cabinet Size(s) ^①	GAM5
BAYWAAA05SC1AA	Hydronic Heater, 40,000 BTUH, Nominal, Slide-in, No Control	A	✓
BAYWABB07SC1AA	Hydronic Heater, 50,000 BTUH, Nominal, Slide-in, No Control	B	✓
BAYWACC08SC1AA	Hydronic Heater, 65,000 BTUH, Nominal, Slide-in, No Control	C	✓
BAYWACC11SC1AA	Hydronic Heater, 100,000 BTUH, Nominal, External Top Mount, No Control ^⑦	C	✓
BAYSUPFLGAA	Supply Duct Flange A	A	✓
BAYSUPFLGBA	Supply Duct Flange B	B	✓
BAYSUPFLGCA	Supply Duct Flange C	C	✓
BAYRETFLGAA	Return Duct Flange A	A	✓
BAYRETFLGBA	Return Duct Flange B	B	✓
BAYRETFLGCA	Return Duct Flange C	C	✓
BAYFLR1620A	Washable high velocity filter, 16" x 20" x 1" (10 filters)	A	✓
BAYFLR2020A	Washable high velocity filter, 20" x 20" x 1" (10 filters)	B	✓
BAYFLR2220A	Washable high velocity filter, 22" x 20" x 1" (10 filters)	C	✓
TASB175SB ^{②④}	Plenum Stand with Integrated Sound Baffle A	A	✓
TASB215SB ^{②④}	Plenum Stand with Integrated Sound Baffle B	B	✓
TASB235SB ^{②④}	Plenum Stand with Integrated Sound Baffle C	C	✓
MTISRKIT1620 ^②	Side Return Kit with 16"x20" Filter	A-C	✓
TASSBK175 ^{②③⑤}	Sound Baffle Kit 17.5" Cabinet	A	✓
TASSBK215 ^{②③⑤}	Sound Baffle Kit 21.5" Cabinet	B	✓
TASSBK235 ^{②③⑤}	Sound Baffle Kit 23.5" Cabinet	C	✓
BAYSPEKT200	Single Power Entry Kit		✓
BAYSRKIT100	Side Return Kit	A-C	✓
BAYFRKIT175	Front Return Kit	A	✓
BAYFRKIT210	Front Return Kit	B	✓
BAYFRKIT235	Front Return Kit	C	✓
BAYHHKIT001	Horizontal Hanger Kit		✓
BAYUVCLK001	UV Lights		✓
BAYLVKIT100A	Low Voltage Conduit Entry Kit		✓
BAYAHEMIKIT001	Air handler Electronic Noise Kit used on Variable Speed Blower Motor		✓
BAYBAFKT175A ^⑥	Baffle Kit 17.5" Cabinet	A	✓
BAYBAFKT215A ^⑥	Baffle Kit 21.5" Cabinet	B	✓
BAYBAFKT235A ^⑥	Baffle Kit 23.5" Cabinet	C	✓
BAYINSKT175A	Sound Insulation Kit 17.5" Cabinet	A	✓
BAYINSKT215A	Sound Insulation Kit 21.5" Cabinet	B	✓
BAYINSKT235A	Sound Insulation Kit 17.5" through 23.5" Cabinet	A-C	✓
BAYCNDPIP01A	3/4" PVC Threaded Pipe Kit with foam seal (10 kits)		✓
Model Number	Description		GAM5B
BAYATXV1836A	R-22 TXV conversion kit		1½-2
BAYATXV4248A	R-22 TXV conversion kit		2½-3½
BAYATXV6060A	R-22 TXV conversion kit		4-5

① A Cabinet is 17.5" wide, B Cabinet is 21.5" wide, C Cabinet is 23.5" wide.
 ② Contact your distributor for information.
 ③ In return plenum applications, use TASSBK kits for sound reduction.
 ④ In open air applications, Plenum Stand with Sound Baffle provides sound reduction.
 ⑤ Mounts to TASB original plenum stands without integrated sound baffle.
 ⑥ Mounts inside air filter channel on air handler.
 ⑦ TCONT900 Thermostat can not be used with Hydronic heating.

BUILT TO A HIGHER STANDARD™

American Standard
HEATING & AIR CONDITIONING

Series 2 Split System Air Handlers Single Phase 1½-3 Tons

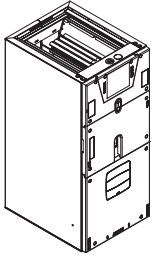

Table AH-9-A — Multi-Speed PSC Motor 200-230/1/60, Epoxy Coated Coil

Unit Model No.	Cooling Capacity (Btuh)	Dimensions (in.) H x W x D	Shipping Weight (lbs.)	Supply Opening	Return Opening	Filter Sizes	Line Size	
							Gas	Liquid
GAF2A0A18S11EE	18000	39.5 x 17.5 x 21.8	117	14.5 x 16.75	14.5 x 17.8	N/A	¾	⅜
GAF2A0A24S21EE	24000	39.5 x 17.5 x 21.8	120	14.5 x 16.75	14.5 x 17.8	N/A	¾	⅜
GAF2A0A30S21EE	30000	39.5 x 17.5 x 21.8	121	14.5 x 16.75	14.5 x 17.8	N/A	¾	⅜
GAF2A0A36S31EE	36000	39.5 x 17.5 x 21.8	122	14.5 x 16.75	14.5 x 17.8	N/A	¾	⅜

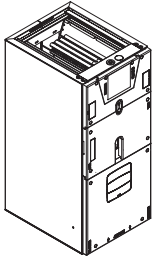

Table AH-9-B — Multi-Speed High Efficiency ECM Motor 200-230/1/60, Epoxy Coated Coil ①

Unit Model No.	Cooling Capacity (Btuh)	Dimensions (in.) H x W x D	Shipping Weight (lbs.)	Supply Opening	Return Opening	Filter Sizes	Line Size	
							Gas	Liquid
GAF2A0A36M31EC	36000	39.5 x 17.5 x 21.8	118	14.5 x 14.35	14.5 x 17.15	N/A	¾	⅜

① High efficiency ECM Motor

Table AH-9-C — Features

	GAF3 1 1/2-3
• Unique cabinet design.....	✓
– 2% or less air leakage.....	✓
– Precision applied - durable door seals.....	✓
– Specially designed air seal around refrigerant, condensate and conduit connections.....	✓
– Double wall foamed cabinet system.....	✓
– ≥ R-4.2 insulating value (Avg. Insulating Value R-8.2).....	✓
– No loose fiber design.....	✓
– Smooth cleanable interior design.....	✓
– Sweat eliminating design.....	✓
– Composite cabinet doors.....	✓
– Water proof cabinet design.....	✓
– Integrated horizontal drain pans.....	✓
• 3 way conversion up flow/horizontal left/right.....	✓
• Front return option.....	✓
• Low voltage pigtail connections.....	✓
• Vortica® blower with polarized plug connections and integrated slide deck for easy removal.....	✓
• Aluminum coil with integrated slide deck for easy removal and polarized plug connections on coil EEV (GAF2A0A36M31).....	3
• Patented enhanced coil fin.....	✓
• Epoxy coated coil.....	✓
• R-410A TXV.....	✓
• Labeled panels and connections.....	✓
• PSC 3 speed motor.....	✓
• Direct drive, multi speed ECM blower motor - Constant torque ECM (electronically commutated motor) (GAF2A0A36M31).....	3
• Maximum width of 23.5".....	✓
• Compact 20.8" depth with doors removed.....	✓
• Fused 24v power.....	✓
• 10-year limited warranty/parts/No Registration Required	✓
• 10-year limited warranty/coil/No Registration Required	✓

For complete equipment / combination selections, installation instructions and warranty information, please refer to Product Data/Ratings and/or Installers Guides and Limited Warranty Handbooks.

Series 2 Split System Air Handlers Single Phase 1½-3 Tons

Table AH-10-A — Optional Accessories

Model		GAF2 ①
Number	Description	
BAYATXV1836	R-22 TXV conversion kit 1-1/2 to 3 ton	✓
BAYBRFBX100	Bottom Return Filter Box	✓
BAYFRKIT100	Front Return Kit	✓
BAYICKSKIT01	Internal Condensate Switch Kit (GAF2A0A36M311SA)	3
BAYLVKIT100	Low Voltage Conduit Entry Kit	✓
BAYRETFLGAA	Return Duct Flange A, A1	✓
BAYSFSCABAA	Supply Duct Flange A1	✓
BAYAHEMIKIT001	Air handler Electronic Noise Kit used on Variable Speed Blower Motor	✓
BAYSRKIT100	Side Return Kit	✓
BAYWMKIT001	Wall Mount Kit	✓
TASB175SB②④	Plenum Stand with Integrated Sound Baffle A	✓
MTISRKIT1620②	Side Return Kit with 16"x20" Filter	✓
TASSBK175②③	Sound Baffle Kit 17.5" Cabinet (mounts to TASB plenum stands)	✓
BAYECPDKIT1	Pull disconnect kit	✓
BAYBAFKT175A	Baffle Kit 17.5" Cabinet (mounts in air handler filter channel)	✓
BAYINSKT175A	Sound Insulation Kit 17.5" Cabinet	✓
BAYINSKT235A	Sound Insulation Kit 17.5" through 23.5" Cabinet	✓
BAYCNDPIP01A	¾" PVC Threaded Pipe Kit with foam seal (10 kits)	✓

- ① The A1 one-piece 17.5" wide cabinet is used on the GAF2 air handlers only.
- ② Contact your distributor for information.
- ③ In return plenum applications, use TASSBK kits for sound reduction.
- ④ In open air applications, Plenum Stand with Sound Baffle provides sound reduction.

Heaters for Multi-Position Air Handlers

Table AH-11-A — BAYEA — Heater, Standard, for Series 9, Series 4, and Series 5 Air Handlers

Heater Model Number	Capacity @ 240 Volts		Capacity @ 208 Volts		Rated Voltage	Control Stages	Number of Heater Racks	Number of Circuits	Heater Amps per Circuit		Contains Circuit Breakers
	kW	BTUH	kW	BTUH					208 Volts	240 Volt	
BAYEAAC04BK1BA	3.84	13100	2.88	9800	208/240/1/60	1	1	1	13.8	16	Yes
BAYEAAC04LG1BA	3.84	13100	2.88	9800	208/240/1/60	1	1	1	13.8	16	No
BAYEAAC05BK1BA	4.80	16400	3.60	12300	208/240/1/60	1	1	1	17.3	20	Yes
BAYEAAC05LG1BA	4.80	16400	3.60	12300	208/240/1/60	1	1	1	17.3	20	No
BAYEAAC08BK1BA	7.68	26200	5.76	19700	208/240/1/60	2	2	1	27.7	32	Yes
BAYEAAC08LG1BA	7.68	26200	5.76	19700	208/240/1/60	2	2	1	27.7	32	No
BAYEAAC10BK1BA	9.60	32800	7.20	24600	208/240/1/60	2	2	1	34.6	40	Yes
BAYEAAC10LG1BA	9.60	32800	7.20	24600	208/240/1/60	2	2	1	34.6	40	No
BAYEABC15BK1BA	14.40	49200	10.80	36900	208/240/1/60	3	3	2	34.6/17.3	40/20	Yes
BAYEABC20BK1BA	19.20	65600	14.40	49200	208/240/1/60	3	4	2	34.6/34.6	40/40	Yes
BAYEACC25BK1BA	24.00	82000	18.00	61500	208/240/1/60	3	5	3	34.6/34.6/17.3	40/40/20	Yes

BK = Contains circuit breakers
LG = Contains lug connections

Table AH-11-B — BAYEC — Heater, Compact, with Lugs, for GAF2 Air Handlers

Heater Model Number	Capacity @ 240 Volts		Capacity @ 208 Volts		Rated Voltage	Control Stages	Number of Heater Racks	Number of Circuits	Heater Amps per Circuit		Contains Circuit Breakers
	kW	BTUH	kW	BTUH					208 Volts	240 Volt	
BAYECAA05LG1BA	4.80	16400	3.60	12300	208/240/1/60	1	1	1	17.3	20	No
BAYECAA08LG1BA	7.68	26200	5.76	19700	208/240/1/60	2	2	1	27.7	32	No
BAYECAA10LG1BA	9.60	32800	7.20	24600	208/240/1/60	2	2	1	34.6	40	No

BAYECPDKIT1 - Optional pull disconnect used with BAYEC heaters only

Table AH-11-C — BAYEA — Heater, 3-Phase, for Series 9, Series 4, and Series 5 Air Handlers ①

Heater Model Number	Capacity @ 240 Volts		Capacity @ 208 Volts		Rated Voltage	Control Stages	Number of Heater Racks	Number of Circuits	Heater Amps per Circuit		Contains Circuit Breakers
	kW	BTUH	kW	BTUH					208 Volts	240 Volt	
BAYEAAC10LG3BA	9.60	32800	7.20	24600	208/240/3/60	1	3	1	20.0	23.1	No
BAYEABC15LG3BA	14.40	49200	10.80	36900	208/240/3/60	1	3	1	30.0	34.6	No

① 3-Phase - W1, W2, W3 must be jumpered at low voltage connector

Heaters for Multi-Position Air Handlers

Table AH-12-A — Air Handler/Heater Matrix

AIR HANDLER MODEL NUMBER	HEATER MODEL NUMBER BAYEA-										
	AC04BK1BA 3.84 Kw BK	AC04LG1BA 3.84 Kw LG	AC05BK1BA 4.80 Kw BK	AC05LG1BA 4.80 Kw LG	AC08BK1BA 7.68 Kw BK	AC08LG1BA 7.68 Kw LG	AC10BK1BA 9.60 Kw BK	AC10LG1BA 9.60 Kw LG	BC15BK1BA 14.40 Kw BK	BC20BK1BA 19.20 Kw BK	CC25BK1BA 24.00 Kw BK
TAM9A0A24V21	Y	Y	Y	Y	Y	Y	Y	Y	—	—	—
TAM9A0B30V31	Y	Y	Y	Y	Y	Y	Y	Y	Y	—	—
TAM9A0C36V31	Y	Y	Y	Y	Y	Y	Y	Y	Y	Y	—
TAM9A0C42V41	Y	Y	Y	Y	Y	Y	Y	Y	Y	Y	—
TAM9A0C48V41	Y	Y	Y	Y	Y	Y	Y	Y	Y	Y	Y
TAM9A0C60V51	Y	Y	Y	Y	Y	Y	Y	Y	Y	Y	Y
GAM5B0A18M11	Y	Y	Y	Y	Y	Y	Y	Y	—	—	—
GAM5B0A24M21	Y	Y	Y	Y	Y	Y	Y	Y	—	—	—
GAM5B0B30M21	Y	Y	Y	Y	Y	Y	Y	Y	Y	—	—
GAM5B0B36M31	Y	Y	Y	Y	Y	Y	Y	Y	Y	—	—
GAM5B0C42M31	Y	Y	Y	Y	Y	Y	Y	Y	Y	—	—
GAM5B0C48M41	Y	Y	Y	Y	Y	Y	Y	Y	Y	Y	Y
GAM5B0C60M51	Y	Y	Y	Y	Y	Y	Y	Y	Y	Y	Y
TAM4A0A18S11	Y	Y	Y	Y	Y	Y	Y	Y	—	—	—
TAM4A0A24S21	Y	Y	Y	Y	Y	Y	Y	Y	—	—	—
TAM4A0A30S21	Y	Y	Y	Y	Y	Y	Y	Y	Y	—	—
TAM4A0A36S31	Y	Y	Y	Y	Y	Y	Y	Y	Y	—	—
TAM4A0B42S31	Y	Y	Y	Y	Y	Y	Y	Y	Y	Y	—
TAM4A0C48S41	Y	Y	Y	Y	Y	Y	Y	Y	Y	Y	Y
TAM4A0C60S51	Y	Y	Y	Y	Y	Y	Y	Y	Y	Y	Y

BK = Contains circuit breakers
LG = Contains lug connections

Table AH-12-B — Air Handler/Heater Matrix (continued)

AIR HANDLER MODEL NUMBER	3 PHASE HEATER MODEL NUMBER BAYEA-		AIR HANDLER MODEL NUMBER	HEATER MODEL NUMBER BAYEC-		
	AC10LG3BA 9.60 Kw LG	BC15LG3BA 9.60 Kw LG		AA05LG1BA 4.80 Kw BK	AA08LG1BA 7.68 Kw LG	AA10LG1BA 9.60 Kw LG
TAM9A0A24V21	Y	—	GAF2A0A18S11	Y	Y	Y
TAM9A0B30V31	Y	Y	GAF2A0A24S21	Y	Y	Y
TAM9A0C36V31	Y	Y	GAF2A0A30S21	Y	Y	Y
TAM9A0C42V41	Y	Y	GAF2A0A36M31	Y	Y	Y
TAM9A0C48V41	Y	Y	GAF2A0A36S31	Y	Y	Y
TAM9A0C60V51	Y	Y	GAF2A0A36S3A	Y	Y	Y
GAM5B0A18M11	Y	—				
GAM5B0A24M21	Y	—				
GAM5B0B30M21	Y	Y				
GAM5B0B36M31	Y	Y				
GAM5B0C42M31	Y	Y				
GAM5B0C48M41	Y	Y				
GAM5B0C60M51	Y	Y				
TAM4A0A18S11	Y	—				
TAM4A0A24S21	Y	—				
TAM4A0A30S21	Y	Y				
TAM4A0A36S31	Y	Y				
TAM4A0B42S31	Y	Y				
TAM4A0C48S41	Y	Y				
TAM4A0C60S51	Y	Y				

LG = Contains lug connections

For complete equipment / combination selections, installation instructions and warranty information, please refer to Product Data/Ratings and/or Installers Guides and Limited Warranty Handbooks.

TEM Split System Air Handlers Single Phase 1½-5 Tons

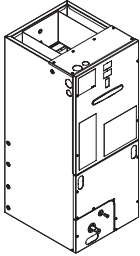

Table AH-13-A — R-410A AccuLink™ II or 24V Variable Speed Air Handler 208-230/1/60

Unit Model No.	Cooling Capacity (Btuh)	Dimensions (in.) H x W x D	Shipping Weight (lbs.)	Supply Opening	Return Opening	Filter Sizes	Line Size	
							Gas	Liquid
TEM8A0B24V21DB	24000	46.75 x 18.5 x 21.13	126	16.5 x 12.15	16.75 x 18.75	①	¾	¾
TEM8A0B30V31DB	30000	46.75 x 18.5 x 21.13	126	16.5 x 12.15	16.75 x 18.75	①	¾	¾
TEM8A0C36V31DB	36000	51.27 x 23.5 x 21.13	155	21.5 x 12.15	21.75 x 18.75	①	7/8	¾
TEM8A0C42V41DB	42000	51.27 x 23.5 x 21.13	155	21.5 x 12.15	21.75 x 18.75	①	7/8	¾
TEM8A0C48V41DB	48000	55.75 x 23.5 x 21.13	185	21.5 x 12.15	21.75 x 18.75	①	7/8	¾
TEM8A0D48V41DB	48000	53.87 x 26.5 x 21.13	181	24.5 x 12.15	24.75 x 18.75	①	7/8	¾
TEM8A0C60V51DB	60000	55.75 x 23.5 x 21.13	185	21.5 x 12.15	21.75 x 18.75	①	7/8	¾
TEM8A0D60V51DB	60000	53.87 x 26.5 x 21.13	181	24.5 x 12.15	24.75 x 18.75	①	7/8	¾

① Filter not supplied. Remote filter required.

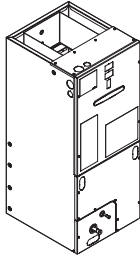

Table AH-13-B — R-410A Convertible Variable Speed Air Handler 208-230/1/60

Unit Model No.	Cooling Capacity (Btuh)	Dimensions (in.) H x W x D	Shipping Weight (lbs.)	Supply Opening	Return Opening	Filter Sizes	Line Size	
							Gas	Liquid
TEM6A0B24H21SB	24000	46.75 x 18.5 x 21.13	126	16.5 x 12.15	16.75 x 18.75	①	¾	¾
TEM6A0B30H21SB	30000	46.75 x 18.5 x 21.13	126	16.5 x 12.15	16.75 x 18.75	①	¾	¾
TEM6A0C36H31SB	36000	51.27 x 23.5 x 21.13	155	21.5 x 12.15	21.75 x 18.75	①	7/8	¾
TEM6A0C42H41SB	42000	51.27 x 23.5 x 21.13	155	21.5 x 12.15	21.75 x 18.75	①	7/8	¾
TEM6A0C48H41SB	48000	55.75 x 23.5 x 21.13	185	21.5 x 12.15	21.75 x 18.75	①	7/8	¾
TEM6A0D48H41SB	48000	53.87 x 26.5 x 21.13	181	24.5 x 12.15	24.75 x 18.75	①	7/8	¾
TEM6A0C60H51SB	60000	55.75 x 23.5 x 21.13	185	21.5 x 12.15	21.75 x 18.75	①	7/8	¾
TEM6A0D60H51SB	60000	53.87 x 26.5 x 21.13	181	24.5 x 12.15	24.75 x 18.75	①	7/8	¾

① Filter not supplied. Remote filter required.

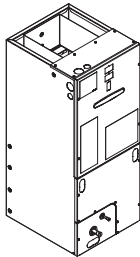

Table AH-13-C — R-410A Convertible Air Handler 208-230/1/60

Unit Model No.	Cooling Capacity (Btuh)	Dimensions (in.) H x W x D	Shipping Weight (lbs.)	Supply Opening	Return Opening	Filter Sizes	Line Size	
							Gas	Liquid
TEM4A0B18S21SB	18000	45.02 x 18.5 x 21.13	116	16.5 x 12.15	16.75 x 18.75	①	¾	¾
TEM4A0B24S21SB	24000	45.02 x 18.5 x 21.13	116	16.5 x 12.15	16.75 x 18.75	①	¾	¾
TEM4A0B30S31SB	30000	45.02 x 18.5 x 21.13	116	16.5 x 12.15	16.75 x 18.75	①	¾	¾
TEM4A0B36S31SB	36000	45.02 x 18.5 x 21.13	116	16.5 x 12.15	16.75 x 18.75	①	¾	¾
TEM4A0C37S31SB	36000	51.27 x 23.5 x 21.13	145	21.5 x 12.15	21.75 x 18.75	①	7/8	¾
TEM4A0C42S41SB	42000	51.27 x 23.5 x 21.13	145	21.5 x 12.15	21.75 x 18.75	①	7/8	¾
TEM4A0C48S41SB	48000	51.27 x 23.5 x 21.13	145	21.5 x 12.15	21.75 x 18.75	①	7/8	¾
TEM4A0C60S51SB	60000	51.27 x 23.5 x 21.13	145	21.5 x 12.15	21.75 x 18.75	①	7/8	¾
TEM4A0B19M21SA	24000	45.02 x 18.5 x 21.13	116	16.5 x 12.15	16.75 x 18.75	①	¾	¾
TEM4A0B31M31SA	30000	46.75 x 18.5 x 21.13	126	16.5 x 12.15	16.75 x 18.75	①	¾	¾
TEM4A0C43M41SA	42000	51.27 x 23.5 x 21.13	155	21.5 x 12.15	21.75 x 18.75	①	7/8	¾
TEM4A0C49M41SA	48000	55.75 x 23.5 x 21.13	185	21.5 x 12.15	21.75 x 18.75	①	7/8	¾

① Filter not supplied. Remote filter required.

TEM Split System Air Handlers Single Phase 1½-5 Tons

Table AH-14-A — Features

	TEM8 2-5	TEM6 2-5	TEM4 1 1/2-5
• Painted metal cabinet with captured foil face insulation	✓	✓	✓
• 2% or less air leakage.....	✓	✓	✓
• ComfortLink™ II or 24V operation	✓	—	—
• Direct drive, variable speed ECM blower motor - Constant airflow ECM (electronically commutated)	✓	✓	—
• Direct drive, multi speed ECM blower motor - Constant torque ECM (electronically commutated motor)	—	—	19, 31, 43, 49 3½-5 1½-3
• PSC Motor.....	—	—	—
• R-4.2 Insulating Value	✓	✓	✓
• Multi-Position UP/Down Flow*, Horizontal Left /Right.....	✓	✓	✓
• ALL Aluminum Coil with Enhanced Patented Coil Fin	✓	✓	✓
• Electric Heaters with polarized plug connections (sold as accessory)	✓	✓	✓
• R-410A Thermal Expansion Valve	✓	✓	✓
• Low Voltage Pigtail Connections	✓	✓	✓
• Draw Through Design	✓	✓	✓
• Horizontal Drain pan	✓	✓	✓
• Single Color.....	✓	✓	✓
• Fused 24V Power.....	✓	✓	✓
• Wipeable interior design.....	✓	✓	✓
• Soft start fan motor operation	✓	✓	—
• Comfort R Mode.....	✓	✓	—
• Built in fan delay modes	✓	✓	—
• Maximum Width 26.5"	✓	✓	—
• Maximum Width 23.5"	—	—	✓
• Compact 22" depth	✓	✓	✓
• Draw through design	✓	✓	✓
• 10-year limited warranty/parts/No Registration Required	✓	✓	✓
• 10-year limited warranty/coil/No Registration Required	✓	✓	✓

Table AH-14-B — Optional Accessories

Model Number	Description	Matches Cabinet Size(s)	TEM8	TEM6	TEM4
BAYTEMSPFG1	Supply Duct Flange Kit.....		✓	✓	✓
BAYSPEKT201A	Single Point Power Entry Kit.....		✓	✓	✓
TAYBASE185.....	Air Handler Downflow Sub-Bases	18.5"	✓	✓	✓
TAYBASE235 (TAYBASE100)	Air Handler Downflow Sub-Bases	23.5"	✓	✓	✓
TAYBASE260 (TAYBASE102)	Air Handler Downflow Sub-Bases	26.5"	✓	✓	—
BAYTEMDFKT1A	Downflow Condensate Management Kit.....	23.5" ①	—	—	✓
BAYAHEMIKIT001	Air handler Electronic Noise Kit used on Variable Speed Blower Motor		✓	✓	✓
TEMBRKSEALKT01A	TEM Breaker Seal Kit.....		✓	✓	✓
BAYSF1185AAA.....	Slim Fit Filter Box Kit	18.5"	✓	✓	✓
BAYSF1235AAA.....	Slim Fit Filter Box Kit	23.5"	✓	✓	✓
BAYSF1265AAA.....	Slim Fit Filter Box Kit	26.5"	✓	✓	—
FLRSF1185	1" Slim Fit Replacement Filter, 17.75"x19.75", Qty 12	18.5"	✓	✓	✓
FLRSF1235	1" Slim Fit Replacement Filter, 22.75"x19.75", Qty 12	23.5"	✓	✓	✓
FLRSF1265	1" Slim Fit Replacement Filter, 25.75"x19.75", Qty 12	26.5"	✓	✓	—
BAY6TXV2442A	R-22 TXV conversion kit.....		2-3½	2-3½	—
BAY6TXV4860A	R-22 TXV conversion kit		4-5 ②	4-5 ②	—
BAYATXV1836B	R-22 TXV conversion kit		—	—	1½-2½
BAYATXV4248B	R-22 TXV conversion kit		—	—	3-4
BAYATXV6161B	R-22 TXV conversion kit.....		4-5 ③	4-5 ③	5

① Downflow condensate management kit is required for 5 Ton downflow models.

② TEM6A0D48, TEM6A0D60, TEM8A0D48, TEM8A0D60

③ TEM6A0C48, TEM6A0C60, TEM8A0C48, TEM8A0C60

Heaters for TEM Split System Air Handlers

Table AH-15-A — BAYHTR15 — Heater, Standard, for TEM Air Handlers

Heater Model Number	Capacity @ 240 Volts		Capacity @ 208 Volts		Rated Voltage	Control Stages	Number of Heater Racks	Number of Circuits	Heater Amps per Circuit		Contains Circuit Breakers
	kW	BTUH	kW	BTUH					208 Volts	240Volt	
BAYHTR1504BRKC	3.84	13100	2.88	9800	208/240/1/60	1	1	1	13.8	16	Yes
BAYHTR1504LUGB	3.84	13100	2.88	9800	208/240/1/60	1	1	1	13.8	16	No
BAYHTR1505BRKC	4.80	16400	3.60	12300	208/240/1/60	1	1	1	17.3	20	Yes
BAYHTR1505LUGB	4.80	16400	3.60	12300	208/240/1/60	1	1	1	17.3	20	No
BAYHTR1508BRKC	7.68	26200	5.76	19700	208/240/1/60	1	1	1	27.7	32	Yes
BAYHTR1508LUGB	7.68	26200	5.76	19700	208/240/1/60	1	1	1	27.7	32	No
BAYHTR1510BRKC	9.60	32800	7.20	24600	208/240/1/60	1	2	1	34.6	40	Yes
BAYHTR1510LUGB	9.60	32800	7.20	24600	208/240/1/60	1	2	1	34.6	40	No
BAYHTR1515BRKB	14.4	49200	10.8	36900	208/240/1/60	2	3	2	51.9	60	Yes
BAYHTR1516BRKA	14.4	49200	10.8	36900	208/240/1/60	2	3	2	51.9	60	Yes
BAYHTR1517BRKA	14.4	49200	10.8	36900	208/240/1/60	2	3	2	51.9	60	Yes
BAYHTR1519BRKB	19.2	65500	14.4	49200	208/240/1/60	2	4	2	69.2	80	Yes
BAYHTR1520BRKB	19.2	65500	14.4	49200	208/240/1/60	2	4	2	69.2	80	Yes
BAYHTR1521BRKB	19.2	65500	14.4	49200	208/240/1/60	2	4	2	69.2	80	Yes
BAYHTR1522BRKA	19.2	65500	14.4	49200	208/240/1/60	2	4	2	69.2	80	Yes
BAYHTR1523BRKA	19.2	65500	14.4	49200	208/240/1/60	2	4	2	69.2	80	Yes
BAYHTR1525BRKA	24.0	81900	18.0	61600	208/240/1/60	2	4	2	86.4	100	Yes

Table AH-15-B — BAYHTR35 — Heater, 3-Phase, for TEM Air Handlers ①

Heater Model Number	Capacity @ 240 Volts		Capacity @ 208 Volts		Rated Voltage	Control Stages	Number of Heater Racks	Number of Circuits	Heater Amps per Circuit		Contains Circuit Breakers
	kW	BTUH	kW	BTUH					208 Volts	240Volt	
BAYHTR3510LUGC	9.60	32800	7.20	24600	208/240/3/60	1	3	1	20.0	23.1	No
BAYHTR3515LUGC	14.4	49200	10.8	36900	208/240/3/60	1	3	1	30.0	34.6	No
BAYHTR3517LUGA	14.4	49200	10.8	36900	208/240/3/60	1	3	1	30.0	34.6	No

BRK = Contains circuit breakers

LUG = Lug connections

① 3-Phase - W1 and W2 must be jumpered at low voltage connector

Heater Matches for TEM Split System Air Handlers with metal blower housing

Table AH-16-A — TEM8 and TEM6 Air Handler and Heater matches

TEM6/TEM8 HEATER MATRIX									
AIR HANDLER	HEATER MODEL NUMBER								
MODEL NUMBER	BAYHTR1504BRKC BAYHTR1504LUGB 3.84 Kw	BAYHTR1505BRKC BAYHTR1505LUGB 4.80 Kw	BAYHTR1508BRKC BAYHTR1508LUGB 7.68 Kw	BAYHTR1510BRKC BAYHTR1510LUGB 9.60 Kw	BAYHTR1517BRKA 14.40 Kw	BAYHTR1523BRKA 19.20 Kw	BAYHTR1525BRKA 24.00 Kw	BAYHTR3510LUGC 9.60 Kw	BAYHTR3517LUGA 14.40 Kw
TEM8A0B24V21DB TEM8A0B30V31DB TEM6A0B24H21SB TEM6A0B30H21SB	Y	Y	Y	Y	Y	-	-	Y	Y
TEM8A0C36V31DB TEM8A0C42V41DB TEM6A0C36H31SB TEM6A0C42H41SB	Y	Y	Y	Y	Y	Y	-	Y	Y
TEM8A0C48V41DB TEM8A0C60V51DB TEM6A0C48H41SB TEM6A0C60H51SB	Y	Y	Y	Y	Y	Y	Y	Y	Y
TEM8A0D48V41DB TEM8A0D60V51DB TEM6A0D48H41SB TEM6A0D60H51SB	Y	Y	Y	Y	Y	Y	Y	Y	Y

Table AH-16-B — TEM4 Air Handler and Heater matches

TEM4 HEATER MATRIX					
AIR HANDLER	HEATER MODEL NUMBER				
MODEL NUMBER	BAYHTR1504BRKC BAYHTR1504LUGB 3.84 Kw BK BAYHTR1505BRKC BAYHTR1505LUGB 4.80 Kw BK	BAYHTR1508BRKC BAYHTR1508LUGB 7.68 Kw BK BAYHTR1510BRKC BAYHTR1510LUGB 9.60 Kw BK	BAYHTR1517BRKA BAYHTR3517LUGA 14.40 Kw BK	BAYHTR1523BRKA 19.20 Kw BK	BAYHTR1525BRKA 24.00 Kw BK
TEM4A0B18S21SB TEM4A0B24S21SB	Y	Y	--	--	--
TEM4A0B30S31SB TEM4A0B36S31SB	Y	Y	Y	--	--
TEM4A0C37S31SB TEM4A0C42S41SB	Y	Y	Y	Y	--
TEM4A0C48S41SB	Y	Y	Y	Y	Y
TEM4A0C60S51SB	Y	Y	Y	Y	Y
TEM4A0B19M21SAA	Y	Y	--	--	--
TEM4A0B31M31SAA	Y	Y	Y	--	--
TEM4A0C43M41SAA	Y	Y	Y	Y	--
TEM4A0C49M41SAA	Y	Y	Y	Y	Y

For complete equipment / combination selections, installation instructions and warranty information, please refer to Product Data/Ratings and/or Installers Guides and Limited Warranty Handbooks.

TMM Wall, Stud, or Over the Water Heater Mount Air Handlers Single Phase

1½-3 Tons

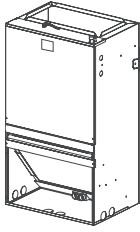

Table AH-17-A — TMM5 R-410A Wall, Stud, or Over the Water Heater Mount Air Handler 208-230/1/60, ECM Motor, Factory installed R-410A TXV, all aluminum coil, Cooling & Limited Heating

Unit Model No.	Cooling Capacity (Btuh)	Dimensions (in.) H x W x D	Shipping Weight (lbs.)	Supply Opening	Filter Sizes	Line Size	
						Gas	Liquid
TMM5B0A24M21SA	24000	36.5 x 20.5 x 15.0	93	15 x 9.5	①	¾	⅜
TMM5B0B30M21SA	30000	39.5 x 22.0 x 19.0	115	19 x 9.5	①	¾	⅜
TMM5B0B36M31SA	36000	39.5 x 22.0 x 19.0	115	19 x 9.5	①	¾	⅜

Table AH-17-B — TMM4 R-410A Wall, Stud, or Over the Water Heater Mount Air Handler 208-230/1/60, PSC Motor, Factory installed R-410A orifice, all aluminum coil, Cooling & Heating

Unit Model No.	Cooling Capacity (Btuh)	Dimensions (in.) H x W x D	Shipping Weight (lbs.)	Supply Opening	Filter Sizes	Line Size	
						Gas	Liquid
TMM4B0A18S21SA	18000	36.5 x 20.5 x 15.0	97	15 x 9.5	①	¾	⅜
TMM4B0A24S21SA	24000	36.5 x 20.5 x 15.0	97	15 x 9.5	①	¾	⅜
TMM4B0B30S21SA	30000	39.5 x 22.0 x 19.0	119	19 x 9.5	①	¾	⅜
TMM4B0B36S31SA	36000	39.5 x 22.0 x 19.0	119	19 x 9.5	①	¾	⅜

① Filter not supplied. Remote filter required.

Table AH-17-C — TMM5 R-410A Wall, Stud, or Over the Water Heater Mount Air Handler 208-230/1/60, ECM Motor, Factory installed R-410A TXV

Unit Model No.	Cooling Capacity (Btuh)	Dimensions (in.) H x W x D	Shipping Weight (lbs.)	Supply Opening	Filter Sizes	Line Size	
						Gas	Liquid
TMM5A0B24M21SA	24000	39.5 x 22.0 x 19.0	115	18.75 x 9.5	①	¾	⅜
TMM5A0B30M21SA	30000	39.5 x 22.0 x 19.0	117	18.75 x 9.5	①	¾	⅜
TMM5A0B36M31SA	36000	39.5 x 22.0 x 19.0	117	18.75 x 9.5	①	¾	⅜

Table AH-17-D — TMM4 R-410A Wall, Stud, or Over the Water Heater Mount Air Handler 208-230/1/60

Unit Model No.	Cooling Capacity (Btuh)	Dimensions (in.) H x W x D	Shipping Weight (lbs.)	Supply Opening	Filter Sizes	Line Size	
						Gas	Liquid
TMM4A0A18S21SA	18000	36.5 x 20.5 x 15.0	99	17.25 x 9.5	①	¾	⅜
TMM4A0A24S21SA	24000	36.5 x 20.5 x 15.0	99	17.25 x 9.5	①	¾	⅜
TMM4A0B30S21SA	30000	39.5 x 22.0 x 19.0	121	18.75 x 9.5	①	¾	⅜
TMM4A0B36S31SA	36000	39.5 x 22.0 x 19.0	121	18.75 x 9.5	①	¾	⅜

① Filter not supplied. Remote filter required.

Table AH-17-E — Features

	TMM5B 2-3	TMM4B 1-1/2-3	TMM5A 2-3	TMM4A 1-1/2-3
• Painted metal cabinet with captured foil face insulation	✓	✓	✓	✓
• 2% or less air leakage	✓	✓	✓	✓
• All aluminum coil	✓	✓	—	—
• Direct drive, multi speed ECM blower motor - Constant torque ECM (electronically commutated motor) with fan-off time delay programming	✓	—	✓	—
• PSC Motor	—	✓	—	—
• Limited HP matched system ratings	—	✓	—	—
• R-4.2 Insulating Value	✓	✓	✓	✓
• Upflow only	✓	✓	✓	✓
• Front return option	✓	✓	✓	✓
• High Efficiency Copper / Aluminum Coil	✓	✓	✓	✓
• Electric Heaters with polarized plug connections (sold as accessory)	✓	✓	✓	✓
• R-410A Thermal Expansion Valve	✓	—	✓	—
• Low Voltage Pigtail Connections	✓	✓	✓	✓
• Single Color	✓	✓	✓	✓
• Fused 24V Power	✓	✓	✓	✓
• Wipeable interior design	✓	✓	✓	✓
• Maximum Height 39.5"	✓	✓	✓	✓
• Maximum Width 22"	✓	✓	✓	✓
• Compact 22" depth	✓	✓	✓	✓
• Optional R-22 and R-410A TXV kits (sold as accessory)	✓	✓	✓	✓
• 10-year limited warranty/parts/No Registration Required	✓	✓	✓	✓
• 10-year limited warranty/coil/No Registration Required	✓	✓	✓	✓

For complete equipment / combination selections, installation instructions and warranty information, please refer to Product Data/Ratings and/or Installers Guides and Limited Warranty Handbooks.

BUILT TO A HIGHER STANDARD[®]

American Standard[®]

HEATING & AIR CONDITIONING

TMM Wall, Stud, or Over the Water Heater Mount Air Handlers Single Phase 1½-3 Tons

Table AH-18-A — Optional Accessories

Model		TMM5B	TMM4B	TMM5A	TMM4A
Number	Description				
4AYTXVH3G2436AR-410A TXV kit 1-1/2 to 3 ton.....	—	✓	—	✓
2AYTXVH3G2436AR-22 TXV conversion kit 1-1/2 to 3 ton.....	✓	✓	✓	✓
BAYFRTLLOUPNL20Front louver panel 20.5" width.....	—	✓	—	✓
BAYFRTLLOUPNL22Front louver panel 22.0" width.....	✓	✓	✓	✓
BAYTMMWALLPNL1Return air / service wall panel (Qty 20).....	✓	✓	✓	✓

Heaters for TMM Split System Air Handlers

Table AH-18-B — BAYHTRM — Heater, Standard, for TMM Air Handlers

Heater Model Number	Capacity @ 240 Volts		Capacity @ 208 Volts		Rated Voltage	Control Stages	Number of Heater Racks	Number of Circuits	Heater Amps per Circuit		Contains Circuit Breakers
	kW	BTUH	kW	BTUH					208 Volts	240Volt	
BAYHTRM505BRK	5.0	17100	3.8	12800	208/240/1/60	1	1	1	18	20.8	Yes
BAYHTRM508BRK	7.5	25600	5.6	19200	208/240/1/60	1	1	1	27.1	31.2	Yes
BAYHTRM510BRK	10.0	34100	7.5	25600	208/240/1/60	1	2	1	36.1	41.7	Yes

GMU/GMV Wall, Stud, or Over the Water Heater Mount Air Handlers w/ Electric Heater Single Phase, 1½-3 Tons

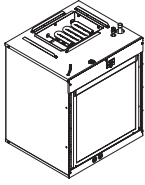

Table AH-19-A — GMU2 AC, R-410A Wall Mount Air Handler 208-230/1/60, with Factory Installed Electric Heater, Cooling Only

Unit Model No.	Cooling Capacity Range (Tons)	Dimensions (in.) H x W x D	Shipping Weight (lbs.)	Supply Opening	Refrigerant Control	Filter Sizes	Line Size		Heater (KW)
							Gas	Liquid	
GMU2APB24051SA	1.5 - 2.0	25.4 x 22.1 x 19.3	70	16.00 x 10.75	FCCV ^①	20 x 20 x 1	¾	⅜	5
GMU2APB24081SA	1.5 - 2.0	25.4 x 22.1 x 19.3	70	16.00 x 10.75	FCCV ^①	20 x 20 x 1	¾	⅜	8
GMU2APB30051SA	2.5	29.4 x 22.1 x 19.3	72	16.00 x 10.75	FCCV ^①	24 x 20 x 1	¾	⅜	5
GMU2APB30081SA	2.5	29.4 x 22.1 x 19.3	72	16.00 x 10.75	FCCV ^①	24 x 20 x 1	¾	⅜	8
GMU2AEB37051SA	2.5 - 3.0	29.4 x 22.1 x 19.3	73	16.00 x 10.75	FCCV ^①	24 x 20 x 1	¾	⅜	5
GMU2AEB37101SA	2.5 - 3.0	29.4 x 22.1 x 19.3	73	16.00 x 10.75	FCCV ^①	24 x 20 x 1	¾	⅜	10

Table AH-19-B — GMV2 HP, R-410A Wall Mount Air Handler 208-230/1/60, with Factory Installed Electric Heater, Cooling and Heating

Unit Model No.	Cooling Capacity Range (Tons)	Dimensions (in.) H x W x D	Shipping Weight (lbs.)	Supply Opening	Refrigerant Control	Filter Sizes	Line Size		Heater (KW)
							Gas	Liquid	
GMV2APB26051SA	1.5 - 2.0	25.4 x 22.1 x 19.3	73	16.00 x 10.75	TXVNB ^{②③}	20 x 20 x 1	¾	⅜	5
GMV2APB26081SA	1.5 - 2.0	25.4 x 22.1 x 19.3	73	16.00 x 10.75	TXVNB ^{②③}	20 x 20 x 1	¾	⅜	8
GMV2APB32051SA	2.5	29.4 x 22.1 x 19.3	74	16.00 x 10.75	TXVNB ^{②③}	24 x 20 x 1	¾	⅜	5
GMV2APB32081SA	2.5	29.4 x 22.1 x 19.3	74	16.00 x 10.75	TXVNB ^{②③}	24 x 20 x 1	¾	⅜	8
GMV2AEB39051SA	2.5 - 3.0	29.4 x 22.1 x 19.3	75	16.00 x 10.75	TXVNB ^{②③}	24 x 20 x 1	¾	⅜	5
GMV2AEB39101SA	2.5 - 3.0	29.4 x 22.1 x 19.3	75	16.00 x 10.75	TXVNB ^{②③}	24 x 20 x 1	¾	⅜	10

- ① All Air Handlers shipped with a fixed Metering Device (Flow Control Check Valve - FCCV)
- ② Start Kit may be required on outdoor unit
- ③ Shipped with TXV, field installed

Table AH-19-C — Features

	GMU2	GMV2
• Stud Mount, Wall Mount, and Over the Water Heater Mount applications	✓	✓
• Unpainted, Galvanized Metal Cabinet with captured foil face insulation	✓	✓
• Wipeable interior design	✓	✓
• 2% or less air leakage which meets FL and CA building code requirements	✓	✓
• Multi-Speed CTM ECM motor	37	39
• Multi-Speed PSC motor	24-30	26-32
• Upflow only	✓	✓
• Front return only	✓	✓
• All Aluminum Coil to resist corrosion	✓	✓
• Factory Installed 5, 8, & 10 Kw Electric Heaters with polarized plug connections	✓	✓
• Cooling and Heating with ship with, field installed R-410A TXV with mechanical connections on both sides	—	✓
• Cooling Only with factory installed Orifice with mechanical connections on both sides	✓	—
• Approved for manufactured/mobile home use	✓	✓
• Sturdy polycarbonate drain pan	✓	✓
• Front & bottom drain access drain connections	✓	✓
• Coil slab pivots to allow for easy servicing without having to disconnect or pump down refrigerant	✓	✓
• Low Voltage Pigtail Connections	✓	✓
• Fused 24V Power	✓	✓
• Ship with breaker & air filter	✓	✓
• Maximum Height 29.4"	✓	✓
• Width 22.1"	✓	✓
• Compact 19.3" depth	✓	✓
• 10-year limited warranty/parts/No Registration Required	✓	✓
• 10-year limited warranty/coil/No Registration Required	✓	✓

GMU/GMV Wall, Stud, or Over the Water Heater Mount Air Handlers w/ Electric Heater Single Phase, 1½-3 Tons

Table AH-20-A — Optional Accessories

Model Number	Description	Use with
BAYTGM1WALLPNL.....	Large Wall Panel - Quantity 1.....	All GMU2 and GMV2 models
BAYTGM5WALLPNL.....	Large Wall Panel - Quantity 5.....	All GMU2 and GMV2 models
BAYFRT1LVPNL26	Front Return Panel - Quantity 1.....	GMU2APB24051SA, GMU2APB24081SA, GMV2APB26051SA, GMV2APB26081SA models
BAYFRT5LVPNL26	Front Return Panel - Quantity 5.....	GMU2APB24051SA, GMU2APB24081SA, GMV2APB26051SA, GMV2APB26081SA models
BAYFRT1LVPNL30	Front Return Panel - Quantity 1.....	GMU2APB30051SA, GMU2APB30081SA, GMU2AEB37051SA, GMU2AEB37101SA, GMV2APB32051SA, GMV2APB32081SA, GMV2AEB39051SA, GMV2AEB39101SA models
BAYFRT5LVPNL30	Front Return Panel - Quantity 5.....	GMU2APB30051SA, GMU2APB30081SA, GMU2AEB37051SA, GMU2AEB37101SA, GMV2APB32051SA, GMV2APB32081SA, GMV2AEB39051SA, GMV2AEB39101SA models

Table AH-20-B — GMU Factory Installed Orifices

GMU Model Number	Tonnage	Factory Installed Refrigerant Control Device	Extra Orifice Sizes Shipped with Unit Not Installed
GMU2APB24051SA	1.5 – 2.0	Orifice (0.057 size)	0.049 size
GMU2APB24081SA	1.5 – 2.0	Orifice (0.057 size)	0.049 size
GMU2APB30051SA	2.5	Orifice (0.061 size)	n/a
GMU2APB30081SA	2.5	Orifice (0.061 size)	n/a
GMU2AEB37051SA	2.5 – 3.0	Orifice (0.067 size)	n/a
GMU2AEB37101SA	2.5 – 3.0	Orifice (0.067 size)	n/a

Table AH-20-C — Orifice kit table

Outdoor Unit Capacity (Tons)	Orifice Size (R410A or R22)	Orifice Kit	GMU2	GMV2
1.5.....	.049	BAYORIACHP0049A.....	✓	—
2.0.....	.057	BAYORIACHP0057A.....	✓	—
2.5.....	.061	BAYORIACHP0061A.....	✓	—
3.0.....	.067	BAYORIACHP0067A.....	✓	—

BUILT TO A HIGHER STANDARD™

American Standard
HEATING & AIR CONDITIONING

P-Series Modular Blower - Variable Speed



Table AH-21-A — P-Series Modular Blower - Variable Speed

Model Number	Nominal Airflow (Tons)	Blower Motor	Uncrated Dimensions (in.)			Shipping Weight (lbs.)	Max. Fuse	Filter** Sizes
			H	W	D			
P0V0A000M30SAA	3	VS①	34	14 ^{1/2}	28 ^{3/4}	83	15	14 x 25 x 1
P0V0B000M40SAA	4	VS①	34	17 ^{1/2}	28 ^{3/4}	92	15	16 x 25 x 1
P0V0C000M50SAA	5	VS①	34	21	28 ^{3/4}	101	15	20 x 25 x 1
P0V0D000M50SAA	5	VS①	34	24 ^{1/2}	28 ^{3/4}	107	15	24 x 25 x 1

Table AH-21-B — Features

	POVO
• 34 Inch Cabinet Height.....	✓
• High efficiency, variable speed blower motor.....	✓
• Vortica™ II blower housing design.....	✓
• Fully insulated cabinet ②.....	✓
• 4-way multi-poise.....	✓
• Painted cabinet with two tone color.....	✓
• Cabinet is certified to less than 1% leakage.....	✓
• Matches industry standard furnace widths (14.5", 17.5", 21", 24.5").....	✓
• 120V wiring connections.....	✓
• Entirely electric operation.....	✓
• Service diagnostic capabilities.....	✓
• Dry contact humidifier/EAC terminals.....	✓
• 10-year limited warranty on all functional parts	✓

① Variable Speed

② 14.5" models do not have blower compartment insulation

** Filters are not shipped with modular blower.

Split System – Cased Heat Pump and Cooling Coils

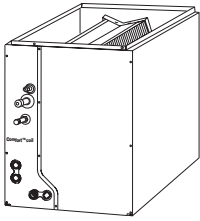

**4TXC
Comfort™ Coil**

Table COIL-1-A — Aluminum High Efficiency Staged System Cased Convertible Coils (Upflow/ Downflow/ Horizontal Left or Right) R-410A Refrigerant

Model Number	Cooling Capacity Range (Tons)	Coil Type	Refrigerant Control	Outlet Dim. (in.) W/H x D	Overall Dim. (in.) H x W x D	Shipping Weight (lbs.)	Line Size OD Gas	Line Size OD Liq.
4TXCA002DS3HCA	1.5 - 2.0	A	TXVNB ^①	12 ³ / ₄ x 19 ³ / ₈	17.5 x 14.5 x 21.5	42	3/4	3/8
4TXCA032DS3HCA	1.5 - 3.0	A	TXVNB ^①	12 ³ / ₄ x 19 ³ / ₈	22.5 x 14.5 x 21.5	46	3/4	3/8
4TXCB003DS3HCA	1.5 - 3.0	A	TXVNB ^①	15 ³ / ₄ x 19 ³ / ₈	17.5 x 17.5 x 21.5	50	3/4	3/8
4TXCB004DS3HCA	2.0 - 3.5	A	TXVNB ^①	15 ³ / ₄ x 19 ³ / ₈	22.5 x 17.5 x 21.5	58	7/8	3/8
4TXCC005DS3HCA	2.0 - 4.0	A	TXVNB ^①	19 ¹ / ₄ x 19 ³ / ₈	22.5 x 21 x 21.5	60	7/8	3/8
4TXCB006DS3HCA	2.0 - 4.0	A	TXVNB ^①	15 ³ / ₄ x 19 ³ / ₈	26.9 x 17.5 x 21.5	65	7/8	3/8
4TXCC007DS3HCA	3.0 - 5.0	A	TXVNB ^①	19 ¹ / ₄ x 19 ³ / ₈	26.9 x 21 x 21.5	69	7/8	3/8
4TXCD008DS3HCA	3.0 - 5.0	A	TXVNB ^①	22 ³ / ₄ x 19 ³ / ₈	26.9 x 24.5 x 21.5	72	7/8	3/8
4TXCC009DS3HCA	3.5 - 5.0	A	TXVNB ^①	19 ¹ / ₄ x 19 ³ / ₈	30.7 x 21 x 21.5	78	7/8	3/8
4TXCD010DS3HCA	3.5 - 5.0	A	TXVNB ^①	22 ³ / ₄ x 19 ³ / ₈	30.7 x 24.5 x 21.5	81	7/8	3/8

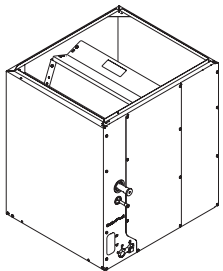

**4PXC-U
Comfort™ Coil**

Table COIL-1-B — Aluminum High Efficiency Staged System Cased Upflow/Downflow Coils R-410A Refrigerant, Convertible to Horizontal Left or Horizontal Right with kit

Model Number	Cooling Capacity Range (Tons)	Coil Type	Refrigerant Control	Outlet Dim. (in.) W/H x D	Overall Dim. (in.) H x W x D	Shipping Weight (lbs.)	Line Size OD Gas	Line Size OD Liq.
4PXCAU24BS3HAA	1.5 - 2.0	A	TXVNB ^①	12 ³ / ₄ x 19 ³ / ₈	17.5 x 14.5 x 21.5	39	3/4	3/8
4PXCBU24BS3HAA	1.5 - 2.0	A	TXVNB ^①	15 ³ / ₄ x 19 ³ / ₈	17.5 x 17.5 x 21.5	42	3/4	3/8
4PXCAU32BS3HAA	1.5 - 3.0	A	TXVNB ^①	12 ³ / ₄ x 19 ³ / ₈	22.5 x 14.5 x 21.5	43	3/4	3/8
4PXCBU30BS3HAA	1.5 - 3.0	A	TXVNB ^①	15 ³ / ₄ x 19 ³ / ₈	17.5 x 17.5 x 21.5	47	3/4	3/8
4PXCCU30BS3HAA	1.5 - 3.0	A	TXVNB ^①	19 ¹ / ₄ x 19 ³ / ₈	17.5 x 21 x 21.5	49	3/4	3/8
4PXCBU36BS3HAA	2.0 - 3.5	A	TXVNB ^①	15 ³ / ₄ x 19 ³ / ₈	22.5 x 17.5 x 21.5	54	7/8	3/8
4PXCCU36BS3HAA	2.0 - 4.0	A	TXVNB ^①	19 ¹ / ₄ x 19 ³ / ₈	22.5 x 21 x 21.5	56	7/8	3/8
4PXCBU42BS3HAA	2.0 - 3.5	A	TXVNB ^①	15 ³ / ₄ x 19 ³ / ₈	26.9 x 17.5 x 21.5	61	7/8	3/8
4PXCCU42BS3HAA	2.5 - 3.5	A	TXVNB ^①	19 ¹ / ₄ x 19 ³ / ₈	26.9 x 21 x 21.5	64	7/8	3/8
4PXCBU48BS3HAA	2.0 - 4.0	A	TXVNB ^①	15 ³ / ₄ x 19 ³ / ₈	26.9 x 17.5 x 21.5	61	7/8	3/8
4PXCCU48BS3HAA	3.0 - 5.0	A	TXVNB ^①	19 ¹ / ₄ x 19 ³ / ₈	26.9 x 21 x 21.5	64	7/8	3/8
4PXCUD48BS3HAA	3.0 - 5.0	A	TXVNB ^①	22 ³ / ₄ x 19 ³ / ₈	26.9 x 24.5 x 21.5	68	7/8	3/8
4PXCCU60BS3HAA	3.5 - 5.0	A	TXVNB ^①	19 ¹ / ₄ x 19 ³ / ₈	30.7 x 21 x 21.5	73	7/8	3/8
4PXCUD60BS3HAA	3.5 - 5.0	A	TXVNB ^①	22 ³ / ₄ x 19 ³ / ₈	30.7 x 24.5 x 21.5	77	7/8	3/8

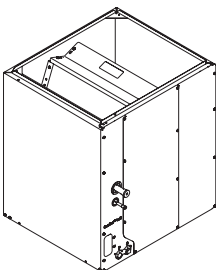

**4PXC-D
Comfort™ Coil**

Table COIL-1-C — Aluminum High Efficiency Staged System Cased Downflow Coils R-410A Refrigerant, Convertible to Horizontal Right with kit

Model Number	Cooling Capacity Range (Tons)	Coil Type	Refrigerant Control	Outlet Dim. (in.) W/H x D	Overall Dim. (in.) H x W x D	Shipping Weight (lbs.)	Line Size OD Gas	Line Size OD Liq.
4PXCBD30BS3HDA	1.5 - 3.0	A	TXVNB ^①	15 ³ / ₄ x 19 ³ / ₈	17.5 x 17.5 x 21.5	47	3/4	3/8
4PXCBD36BS3HDA	2.0 - 3.5	A	TXVNB ^①	15 ³ / ₄ x 19 ³ / ₈	22.5 x 17.5 x 21.5	54	7/8	3/8
4PXCBD42BS3HDA	2.0 - 3.5	A	TXVNB ^①	15 ³ / ₄ x 19 ³ / ₈	26.9 x 17.5 x 21.5	61	7/8	3/8
4PXCCD42BS3HDA	2.5 - 3.5	A	TXVNB ^①	19 ¹ / ₄ x 19 ³ / ₈	26.9 x 21 x 21.5	64	7/8	3/8
4PXCCD60BS3HDA	3.5 - 5.0	A	TXVNB ^①	19 ¹ / ₄ x 19 ³ / ₈	30.7 x 21 x 21.5	73	7/8	3/8
4PXCCD60BS3HDA	3.5 - 5.0	A	TXVNB ^①	22 ³ / ₄ x 19 ³ / ₈	30.7 x 24.5 x 21.5	77	7/8	3/8
4PXCAD24BS3HDA	1.5 - 2.0	A	TXVNB ^①	12 ³ / ₄ x 19 ³ / ₈	17.5 x 14.5 x 21.5	39	3/4	3/8
4PXCBD24BS3HDA	1.5 - 2.0	A	TXVNB ^①	15 ³ / ₄ x 19 ³ / ₈	17.5 x 17.5 x 21.5	42	3/4	3/8
4PXCCD30BS3HDA	1.5 - 3.0	A	TXVNB ^①	19 ¹ / ₄ x 19 ³ / ₈	17.5 x 21 x 21.5	49	3/4	3/8
4PXCCD36BS3HDA	2.0 - 4.0	A	TXVNB ^①	19 ¹ / ₄ x 19 ³ / ₈	22.5 x 21 x 21.5	56	7/8	3/8
4PXCBD48BS3HDA	2.0 - 4.0	A	TXVNB ^①	15 ³ / ₄ x 19 ³ / ₈	26.9 x 17.5 x 21.5	61	7/8	3/8
4PXCCD48BS3HDA	3.0 - 5.0	A	TXVNB ^①	19 ¹ / ₄ x 19 ³ / ₈	26.9 x 21 x 21.5	64	7/8	3/8
4PXCCD48BS3HDA	3.0 - 5.0	A	TXVNB ^①	22 ³ / ₄ x 19 ³ / ₈	26.9 x 24.5 x 21.5	68	7/8	3/8

① Start Kit may be required on outdoor unit.

Split System – Uncased Heat Pump and Cooling Coils

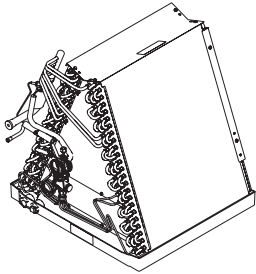

**4PXA
Comfort™ Coil**

Table COIL-2-A — Aluminum Uncased Upflow Coils R-410A Refrigerant

Model Number	Cooling Capacity Range (Tons)	Coil Type	Refrigerant Control	Overall Dim. (in.) H x W x D	Shipping Weight (lbs.)	Line Size	
						OD Gas	OD Liq.
4PXAAU24BS3HAA	1.5 - 2.0	A	TXVNB①	14.7 x 13.3 x 21.1	24	3/4	3/8
4PXABU24BS3HAA	1.5 - 2.0	A	TXVNB①	14.5 x 16.3 x 21.1	24	3/4	3/8
4PXABU30BS3HAA	1.5 - 3.0	A	TXVNB①	15.8 x 16.3 x 21.1	32	3/4	3/8
4PXACU30BS3HAA	1.5 - 3.0	A	TXVNB①	15.8 x 19.8 x 21.1	32	3/4	3/8
4PXABU36BS3HAA	2.0 - 3.5	A	TXVNB①	21.2 x 16.3 x 21.1	33	7/8	3/8
4PXACU36BS3HAA	2.0 - 4.0	A	TXVNB①	20.8 x 19.8 x 21.1	32	7/8	3/8
4PXABU42BS3HAA	2.0 - 3.5	A	TXVNB①	23.8 x 16.3 x 21.1	33	7/8	3/8
4PXACU42BS3HAA	2.5 - 3.5	A	TXVNB①	23.7 x 19.8 x 21.1	38	7/8	3/8
4PXABU48BS3HAA	2.0 - 4.0	A	TXVNB①	25.3 x 16.3 x 21.1	36	7/8	3/8
4PXACU48BS3HAA	3.0 - 5.0	A	TXVNB①	24.9 x 19.8 x 21.1	38	7/8	3/8
4PXADU48BS3HAA	3.0 - 5.0	A	TXVNB①	24.5 x 23.3 x 21.1	39	7/8	3/8
4PXACU60BS3HAA	3.5 - 5.0	A	TXVNB①	29.2 x 19.8 x 21.1	44	7/8	3/8
4PXADU60BS3HAA	3.5 - 5.0	A	TXVNB①	28.5 x 23.3 x 21.1	45	7/8	3/8

① Start Kit may be required on outdoor unit.

Table COIL-2-B — 13 SEER Split System - Uncased Coil Enclosures

Model Number	Coils	Used With Furnaces Flush on Both Sides	Dimensions (in.) H x W x D	Shipping Weight (lbs.)
BAYCLE14A1422A	4PXAAU24BS	14½" Wide Furnace	22½ x 14½ x 21½	12
BAYCLE17A1722A	4PXABU24BS, 4PXABU30BS, 4PXABU36BS,	17½" Wide Furnace	22⅝ x 17½ x 21½	14
BAYCLE21A2130A	4PXACU30BS, 4PXACU36BS, 4PXACU42BS, 4PXACU48BS	21" Wide Furnace	30 x 21 x 21½	18
BAYCLE24A2430A	4PXADU48BS, 4PXADU60BS	24½" Wide Furnace	30 x 24½ x 21½	22

Table COIL-2-C - Kits for 4PXC and 4TXC Coils

Horizontal Conversion Kit No.	Use with Coil Model Numbers
BAYCONV18A	4PXC**24-30
BAYCONV23A	4PXC**36
BAYCONV27A	4PXC**42-48
BAYCONV30A	4PXC**60
Optional Downflow Gasket Kit No.	Use with Coil Model Numbers
BAYGSKT001A0	4TXC, 4PXC

Table COIL-2-D - Air Conditioning and Heat Pump Systems

ADJUSTABLE R410A TXV KIT	4PXC-U & 4PXA:	4PXC-D	4TXC:	A4MX:
4AYTXVH4A1830A	24	24-30	A002	A1824
4AYTXVH4A3042A	30-42	36-42	A032, B003-C005	B1832, A3036, B3642, C3642, B4248
4AYTXVH4A4860A	48-60	48-60	B006-D010	C4248, D4248, C4260, D4260

These R-410A adjustable TXV kits are intended for use with A4MX, 4TXC, 4PXC, and 4PXA coil families.

These adjustable TXV kits may be used to improve efficiency and ratings on the AMERISTAR A4MX Multi-Position coils.

In addition, these adjustable TXV kits may also be used to lower the superheat on 4TXC, 4PXC, and 4PXA coils to improve the latent capacity in high humidity environments.

Table COIL-2-E - R-22 TXV Conversion TXV Kits for 4PXC, 4PXA, 4TXC and 4XTF Coils

R-22 TXV Kit	Use with Coil Model Numbers		
2AYTXVH3H1836A	4PX**24-36	4TXC*002-005	4TXF*24-33
2AYTXVH3H4248A	4PX**42-48	4TXC*006-008	4TXF*36-41
2AYTXVH3H6060A	4PX**60	4TXC*009-010	4TXF*54-64

Split System – Cased Heat Pump and Cooling Coils

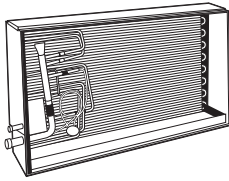

4TXF

Table COIL-3-A — Aluminum Cased Horizontal Flat Coils R-410A Refrigerant

Model Number	Cooling Capacity Range (Tons)	Coil Type	Refrigerant Control	Outlet Dim. (in.) W/H x D	Overall Dim. (in.) H x W x D	Shipping Weight (lbs.)	Line Size OD Gas	Line Size OD Liq.
4TXFH033CC3HHB	1.5 - 3.0	Flat	TXVNB ^①	21 x 24	22.7 x 10.2 x 28.2	49	3/4	5/16
4TXFH041CC3HHB	2.0 - 3.5	Flat	TXVNB ^①	21 x 33 1/4	22.7 x 10.2 x 37.5	57	3/4	3/8
4TXFH054CC3HHB	3.0 - 5.0	Flat	TXVNB ^①	21 x 33 1/4	22.7 x 10.2 x 37.5	55	7/8	3/8
Variable Speed OD compatible models								
4TXFH024CZ3HHB	1.5 - 2.0	Flat	TXVNB ^①	21 x 33 1/4	22.7 x 10.2 x 37.5	48	5/8	3/8
4TXFH036CZ3HHB	2.0 - 3.5	Flat	TXVNB ^①	21 x 33 1/4	22.7 x 10.2 x 37.5	53	3/4	3/8
4TXFH064AZ3HHA	3.0 - 5.0	Flat	TXVNB ^①	27 x 33 1/4	28.6 x 10.2 x 37.5	63	7/8	3/8

^① Start Kit may be required on outdoor unit.

Split System – Cased Heat Pump and Cooling Coils

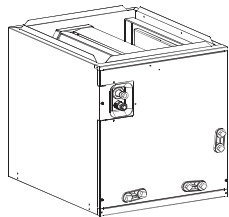

4MXC

Table COIL-3-B — Aluminum Single Stage Cased Coil (Upflow/Downflow/Horizontal) R-410A Refrigerant

Model Number	Cooling Capacity Range (Tons)	Coil Type	Refrigerant Control	Outlet Dim. (in.) W/H x D	Overall Dim. (in.) H x W x D	Shipping Weight (lbs.)	Line Size OD Gas	Line Size OD Liq.
4MXCA001AC6HCA ^①	1.5 - 2.5	A	FCCV ^③	13 x 19	20 x 14.5 x 21	51	3/4	3/8
4MXCB002AC6HCA ^①	1.5 - 2.5	A	FCCV ^③	16 x 19	20 x 17.5 x 21	55	3/4	3/8
4MXCA003AC6HCA ^①	1.5 - 3.0	A	FCCV ^③	13 x 19	20 x 14.5 x 21	51	3/4	3/8
4MXCB004AC6HCA ^①	1.5 - 3.0	A	FCCV ^③	16 x 19	20 x 17.5 x 21	55	3/4	3/8
4MXCC005AC6HCA ^①	2.5 - 3.0	A	FCCV ^③	19 1/2 x 19	20 x 21 x 21	59	3/4	3/8
4MXCB006AC6HCA ^①	3.0 - 4.0	A	FCCV ^③	16 x 19	26 x 17.5 x 21	66	7/8	3/8
4MXCC007AC6HCA ^①	3.0 - 4.0	A	FCCV ^③	19 1/2 x 19	26 x 21 x 21	70	7/8	3/8
4MXCD008AC6HCA ^①	3.5 - 4.0	A	FCCV ^③	23 x 19	26 x 24.5 x 21	74	7/8	3/8
4MXCC009AC6HCA ^①	3.5 - 5.0	A	FCCV ^③	19 1/2 x 19	30 x 21 x 21	91	7/8	3/8
4MXCD010AC6HCA ^①	3.5 - 5.0	A	FCCV ^③	23 x 19	30 x 24.5 x 21	95	7/8	3/8
4MXCB016AC6HCA ^{①②}	3.0 - 4.0	A	FCCV ^③	16 x 19	30 x 17.5 x 21	82	7/8	3/8
4MXCC017AC6HCA ^{①②}	3.0 - 4.0	A	FCCV ^③	19 1/2 x 19	30 x 21 x 21	88	7/8	3/8
4MXCD018AC6HCA ^{①②}	3.5 - 4.0	A	FCCV ^③	23 x 19	30 x 24.5 x 21	92	7/8	3/8

Table COIL-3-C — Aluminum Single Stage Cased Coil (Upflow/Downflow) R-410A Refrigerant

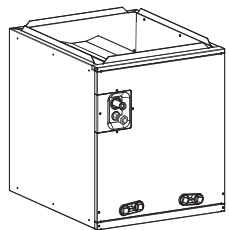

4GXC

Model Number	Cooling Capacity Range (Tons)	Coil Type	Refrigerant Control	Outlet Dim. (in.) W/H x D	Overall Dim. (in.) H x W x D	Shipping Weight (lbs.)	Line Size OD Gas	Line Size OD Liq.
4GXCA001AC6HUA ^①	1.5 - 2.5	A	FCCV ^③	13 x 19	20 x 14.5 x 21	47	3/4	3/8
4GXCB002AC6HUA ^①	1.5 - 2.5	A	FCCV ^③	16 x 19	20 x 17.5 x 21	50	3/4	3/8
4GXCA003AC6HUA ^①	1.5 - 3.0	A	FCCV ^③	13 x 19	20 x 14.5 x 21	47	3/4	3/8
4GXCB004AC6HUA ^①	1.5 - 3.0	A	FCCV ^③	16 x 19	20 x 17.5 x 21	50	3/4	3/8
4GXCC005AC6HUA ^①	2.5 - 3.0	A	FCCV ^③	19 1/2 x 19	20 x 21 x 21	55	3/4	3/8
4GXCB006AC6HUA ^①	3.0 - 4.0	A	FCCV ^③	16 x 19	26 x 17.5 x 21	61	7/8	3/8
4GXCC007AC6HUA ^①	3.0 - 4.0	A	FCCV ^③	19 1/2 x 19	26 x 21 x 21	65	7/8	3/8
4GXCD008AC6HUA ^①	3.5 - 4.0	A	FCCV ^③	23 x 19	26 x 24.5 x 21	69	7/8	3/8
4GXCC009AC6HUA ^①	3.5 - 5.0	A	FCCV ^③	19 1/2 x 19	30 x 21 x 21	85	7/8	3/8
4GXCD010AC6HUA ^①	3.5 - 5.0	A	FCCV ^③	23 x 19	30 x 24.5 x 21	89	7/8	3/8
4GXCB016AC6HUA ^{①②}	3.0 - 4.0	A	FCCV ^③	16 x 19	30 x 17.5 x 21	76	7/8	3/8
4GXCC017AC6HUA ^{①②}	3.0 - 4.0	A	FCCV ^③	19 1/2 x 19	30 x 21 x 21	81	7/8	3/8
4GXCD018AC6HUA ^{①②}	3.5 - 4.0	A	FCCV ^③	23 x 19	30 x 24.5 x 21	85	7/8	3/8

^① Substitutions will be required for 4GXC and 4MXC models. In some cases, use of the Ameristar A4MX Multi-Position Coils may be required.

^② Enhanced models for use in heating.

^③ All coils shipped with a Fixed Metering Device (Flow Control Check Valve - FCCV). Some rated combinations require a TXV kit, ordered separately. See the coil installer's Guide for Orifice and TXV matches.

Split System – Cased Heat Pump and Cooling Coils

Table COIL-4-A — Refrigerant TXV Kits

Tons	R-410A TXV Kit (If required)	R-22 TXV Kit (If required)
1.5-3.0	4AYTXVH3G2436A	2AYTXVH3G2436A
3.5-4.0	4AYTXVH3G4248A	2AYTXVH3G4248A
5	4AYTXVH3G6000A	2AYTXVH3G6000A

Note: Additional R-22 Kit combinations can be found in the Accessories section.

Table COIL-4-B — Orifice kit table for 4GXC and 4MXC coils

Outdoor Unit Capacity (Tons)	Orifice Size (R410A)	Orifice Kit	Orifice Size (R22)	Orifice Kit
1.5	0.052	MAYORIACHP0052B	0.052	MAYORIACHP0052B
2	0.058	MAYORIACHP0058B	0.058	MAYORIACHP0058B
2.5*	0.063 / 0.065	MAYORIACHP0063B / 065A	0.065	MAYORIACHP0065A
3	0.070	MAYORIACHP0070B	0.072	MAYORIACHP0072B
3.5	0.075	MAYORIACHP0075B	0.078	MAYORIACHP0078B
4	0.083	MAYORIACHP0083B	0.088	MAYORIACHP0088B
5	0.090	MAYORIACHP0090B	0.096	MAYORIACHP0096B

Note: Orifice size needed for system combination may not be pre-installed. See Table 1 in coil Installation Manual for pre-installed size.

* Necessary Orifice sizes varies for this tonnage. See Table 3 in coil Installation Manual.

Split System – Cased/Uncased Heat Pump and Cooling Coils

Table COIL-4-C — Features

	4TXC	4PXC-U	4PXC-D	4PXA	4TXF	4MXC	4GXC
• All aluminum coil	✓	✓	✓	✓	✓	✓	✓
• Enhanced Fin Surface.....	✓	✓	✓	✓	—	—	—
• 100% foil lined insulation.....	✓	✓	✓	—	✓	✓	✓
• Internally checked non-bleed thermal expansion valve with mechanical fitting on both sides (heat pump operation)①	✓	✓	✓	✓	✓	—	—
• Factory installed fixed orifice. Additional orifices supplied.	—	—	—	—	—	✓	✓
• Optional accessory TXV Kit with mechanical fittings available for higher performance ratings ③	—	—	—	—	—	✓	✓
• Easy case attachment to furnace.....	✓	✓	✓	—	—	✓	✓
• Upflow application	✓	✓	—	✓	—	✓	✓
• Downflow application.....	✓	✓	✓	—	—	✓	✓
• Horizontal Right application	✓	kit	kit	—	✓	✓	—
• Horizontal Left application	✓	kit	—	—	✓	✓	—
• Double sloped non-corrosive drain pan - UL rated 400°F. Compatible with oil furnaces.....	✓	✓	✓	✓	—	—	—
• Single sloped non-corrosive drain pan	—	—	—	—	✓	✓	✓
• Compatible with variable speed and 2 speed outdoor models	✓	✓	✓	✓	②	—	—
• Split inner and outer doors for easy coil inspection and cleaning.....	✓	✓	✓	—	—	—	—
• Painted galvanized steel cabinet to match furnace.....	✓	✓	✓	—	—	✓	✓
• Unpainted galvanized steel cabinet	—	—	—	—	✓	—	—
• 10-year limited warranty on coil, & all other functional parts, with no registration required	✓	✓	✓	✓	✓	✓	✓

① Start kit may be required on outdoor unit.

② See Table COIL-3-A for specific models that are compatible with variable speed outdoor products.

③ Reference AHRI ratings to find correct TXV kit or reference Product Data for additional information.

S9V2-VS – Two Stage ECM Variable Speed

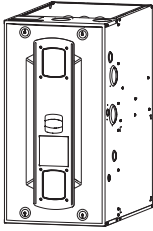

**S9V2-VS
Direct Vent
Upflow**

Table FUR-1-A — S9V2-VS Variable Speed, 2 Stage, Direct/Non-Direct Vent, Upflow/Horizontal Left/Horizontal Right Condensing Gas Furnace with Variable Speed Draft Inducer (120/1/60)③

Unit Model No.	Airflow In Tons	Output (Btuh)		ICS① AFUE	Flue Size (in)	Ignition Device	Uncrated Dimensions (in.) H x W x D	Shipping Weight (lbs.)	Max Fuse*	Filter Sizes**
		Stage 2	Stage 1							
S9V2B040U3VSAB	3	39,141	25,639	97.0②	2, 3, 4	④	34 x 17½ x 28¾	122	15	16 x 25 x 1
S9V2B060U3VSAB	3	57,838	38,271	97.0②	2, 3, 4	④	34 x 17½ x 28¾	127	15	16 x 25 x 1
S9V2B080U3VSAB	3	77,259	51,003	97.0②	2, 3, 4	④	34 x 17½ x 28¾	132	15	16 x 25 x 1
S9V2B080U4VSAB	4	78,400	50,960	97.0②	2, 3, 4	④	34 x 17½ x 28¾	135	15	16 x 25 x 1
S9V2C100U4VSAB	4	96,362	64,036	97.0②	2, 3, 4	④	34 x 21 x 28¾	154	15	20 x 25 x 1
S9V2D120U5VSAB	5	113,145	76,668	97.0②	3, 4	④	34 x 24½ x 28¾	167	15	24 x 25 x 1

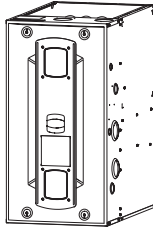

**S9V2-VS
Direct Vent
Downflow**

Table FUR-1-B — S9V2-VS Variable Speed, 2 Stage, Direct/Non-Direct Vent, Downflow Condensing Gas Furnace with Variable Speed Draft Inducer (120/1/60)③

Unit Model No.	Airflow In Tons	Output (Btuh)		ICS① AFUE	Flue Size (in)	Ignition Device	Uncrated Dimensions (in.) H x W x D	Shipping Weight (lbs.)	Max Fuse*	Filter Sizes**
		Stage 2	Stage 1							
S9V2B080D3VSAB	3	76,363	51,091	97.0②	2, 3, 4	④	34 x 17½ x 28¾	132	15	(2)14 x 20 x 1
S9V2B080D4VSAB	4	78,400	50,960	97.0②	2, 3, 4	④	34 x 17½ x 28¾	135	15	(2)14 x 20 x 1
S9V2C100D4VSAB	4	95,833	63,950	97.0②	2, 3, 4	④	34 x 21 x 28¾	154	15	(2)16 x 20 x 1

Note: Variable speed furnaces should not be twinned and are not approved for twinning applications.

① Isolated Combustion System. AFUE may vary based on poise.

② Energy Star.

③ Direct drive variable speed motor is an ECM constant airflow blower motor.

④ Silicon Nitride Igniter.

* Information subject to change. Please confirm with current Product Data/Service Facts for current factory production.

** Filters are not shipped with furnace. For Upflow furnaces, the size is for a bottom return filter.

S9V2 – Two Stage ECM Variable Speed

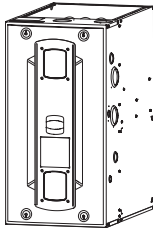

**S9V2
Direct Vent
Upflow**

Table FUR-1-C — S9V2 Variable Speed, 2 Stage, Direct/Non-Direct Vent, Upflow/Horizontal Left/Horizontal Right Condensing Gas Furnace (120/1/60)③

Unit Model No.	Airflow In Tons	Output (Btuh)		ICS① AFUE	Flue Size (in)	Ignition Device	Uncrated Dimensions (in.) H x W x D	Shipping Weight (lbs.)	Max Fuse*	Filter Sizes**
		Stage 2	Stage 1							
S9V2B040U3PSBB	3	38,800	25,220	96.0②	2, 3, 4	④	34 x 17½ x 28¾	122	15	16 x 25 x 1
S9V2B060U3PSBB	3	58,200	37,830	96.0②	2, 3, 4	④	34 x 17½ x 28¾	127	15	16 x 25 x 1
S9V2B060U4PSBB	4	58,200	37,830	96.0②	2, 3, 4	④	34 x 17½ x 28¾	130	15	16 x 25 x 1
S9V2B080U3PSBB	3	77,600	50,440	96.0②	2, 3, 4	④	34 x 17½ x 28¾	132	15	16 x 25 x 1
S9V2B080U4PSBB	4	77,600	50,440	96.0②	2, 3, 4	④	34 x 17½ x 28¾	135	15	16 x 25 x 1
S9V2C080U5PSBB	5	77,600	50,440	96.0②	2, 3, 4	④	34 x 21 x 28¾	149	15	20 x 25 x 1
S9V2C100U4PSBB	4	97,000	63,050	96.0②	2, 3, 4	④	34 x 21 x 28¾	154	15	20 x 25 x 1
S9V2C100U5PSBB	5	97,000	63,050	96.0②	2, 3, 4	④	34 x 21 x 28¾	155	15	20 x 25 x 1
S9V2D120U5PSBB	5	116,400	75,660	96.0②	3, 4	④	34 x 24½ x 28¾	167	15	24 x 25 x 1

Table FUR-1-D — S9V2 Variable Speed, 2 Stage, Direct/Non-Direct Vent, Downflow Condensing Gas Furnace (120/1/60)③

Unit Model No.	Airflow In Tons	Output (Btuh)		ICS① AFUE	Flue Size (in)	Ignition Device	Uncrated Dimensions (in.) H x W x D	Shipping Weight (lbs.)	Max Fuse*	Filter Sizes**
		Stage 2	Stage 1							
S9V2B040D3PSBB	3	38,800	25,220	96.0②	2, 3, 4	④	34 x 17½ x 28¾	122	15	(2)14 x 20 x 1
S9V2B060D3PSBB	3	58,200	37,830	96.0②	2, 3, 4	④	34 x 17½ x 28¾	127	15	(2)14 x 20 x 1
S9V2B080D3PSBB	3	77,600	50,440	96.0②	2, 3, 4	④	34 x 17½ x 28¾	132	15	(2)14 x 20 x 1
S9V2B080D4PSBB	4	77,600	50,440	96.0②	2, 3, 4	④	34 x 17½ x 28¾	135	15	(2)14 x 20 x 1
S9V2C100D4PSBB	4	97,000	63,050	96.0②	2, 3, 4	④	34 x 21 x 28¾	154	15	(2)16 x 20 x 1
S9V2C100D5PSBB	5	97,000	63,050	96.0②	2, 3, 4	④	34 x 21 x 28¾	155	15	(2)16 x 20 x 1
S9V2D120D5PSBB	5	116,400	75,660	96.0②	3, 4	④	34 x 24½ x 28¾	167	15	(2)16 x 20 x 1

Note: Variable speed furnaces should not be twinned and are not approved for twinning applications.

① Isolated Combustion System. AFUE may vary based on poise.

② Energy Star.

③ Direct drive variable speed motor is an ECM constant airflow blower motor.

④ Silicon Nitride Igniter.

* Information subject to change. Please confirm with current Product Data/Service Facts for current factory production.

** Filters are not shipped with furnace. For Upflow furnaces, the size is for a bottom return filter.

S9X2 – Two Stage High Efficiency ECM

Table FUR-2-A — S9X2 High Efficiency 9 Speed ECM Motor, 2 Stage, Direct/Non-Direct Vent, Upflow/Horizontal Left/Horizontal Right Condensing Gas Furnace (120/1/60)^③

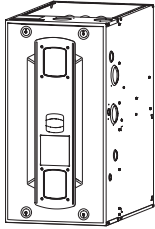

**S9X2
Direct Vent
Upflow**

Unit Model No.	Airflow In Tons	Output (Btuh)		ICS ^① AFUE	Flue Size (in)	Ignition Device	Uncrated Dimensions (in.) H x W x D	Shipping Weight (lbs.)	Max Fuse*	Filter Sizes**
		Stage 2	Stage 1							
S9X2B040U2PSAB	2	38,800	25,220	96.0 ^②	2, 3, 4	④	34 x 17½ x 28¾	122	15	16 x 25 x 1
S9X2B040U3PSBA	3	38,800	25,220	96.0 ^②	2, 3, 4	④	34 x 17½ x 28¾	122	15	16 x 25 x 1
S9X2B060U3PSAB	3	58,200	37,830	96.0 ^②	2, 3, 4	④	34 x 17½ x 28¾	127	15	16 x 25 x 1
S9X2B060U4PSBA	4	58,200	37,830	96.0 ^②	2, 3, 4	④	34 x 17½ x 28¾	130	15	16 x 25 x 1
S9X2B080U3PSAB	3	77,600	50,440	96.0 ^②	2, 3, 4	④	34 x 17½ x 28¾	132	15	16 x 25 x 1
S9X2B080U4PSBA	4	77,600	50,440	96.0 ^②	2, 3, 4	④	34 x 17½ x 28¾	135	15	16 x 25 x 1
S9X2C080U4PSAB	4	77,600	50,440	96.0 ^②	2, 3, 4	④	34 x 21 x 28¾	149	15	20 x 25 x 1
S9X2C080U5PSBA	5	77,600	50,440	95.0 ^②	2, 3, 4	④	34 x 21 x 28¾	149	15	20 x 25 x 1
S9X2C100U4PSAB	4	97,000	63,050	96.0 ^②	2, 3, 4	④	34 x 21 x 28¾	154	15	20 x 25 x 1
S9X2C100U5PSBA	5	97,000	63,050	96.0 ^②	2, 3, 4	④	34 x 21 x 28¾	155	15	20 x 25 x 1
S9X2D120U5PSBA	5	116,400	75,660	96.0 ^②	3, 4	④	34 x 24½ x 28¾	167	15	24 x 25 x 1

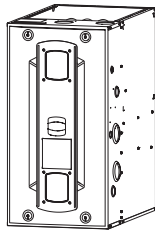

**S9X2
Direct Vent
Downflow**

Table FUR-2-B — S9X2 High Efficiency 9 Speed ECM Motor, 2 Stage, Direct/Non-Direct Vent, Downflow Condensing Gas Furnace (120/1/60)^③

Unit Model No.	Airflow In Tons	Output (Btuh)		ICS ^① AFUE	Flue Size (in)	Ignition Device	Uncrated Dimensions (in.) H x W x D	Shipping Weight (lbs.)	Max Fuse*	Filter Sizes**
		Stage 2	Stage 1							
S9X2B040D2PSAB	2	38,800	25,220	96.0 ^②	2, 3, 4	④	34 x 17½ x 28¾	122	15	(2)14 x 20 x 1
S9X2B040D3PSBA	3	38,800	25,220	96.0 ^②	2, 3, 4	④	34 x 17½ x 28¾	122	15	(2)14 x 20 x 1
S9X2B060D3PSBA	3	58,200	37,830	95.0 ^②	2, 3, 4	④	34 x 17½ x 28¾	127	15	(2)14 x 20 x 1
S9X2B080D4PSBA	4	77,600	50,440	96.0 ^②	2, 3, 4	④	34 x 17½ x 28¾	135	15	(2)14 x 20 x 1
S9X2C100D5PSBA	5	97,000	63,050	95.0 ^②	2, 3, 4	④	34 x 21 x 28¾	155	15	(2)16 x 20 x 1
S9X2D120D5PSBA	5	116,400	75,660	96.0 ^②	3, 4	④	34 x 24½ x 28¾	167	15	(2)16 x 20 x 1

① Isolated Combustion System. AFUE may vary based on poise.

② Energy Star.

③ Direct drive 9 speed motor is a high efficiency constant torque ECM blower motor.

④ Silicon Nitride Igniter.

* Information subject to change. Please confirm with current Product Data/Service Facts for current factory production.

** Filters are not shipped with furnace. For Upflow furnaces, the size is for a bottom return filter.

Table FUR-2-C — High Altitude Pressure Switch S9V2-VS 90% Furnaces

Model Number	Description	Used With	Shipping Weight
BAYHALT250	2 Switches	S9V2B040U3VSA	2
BAYHALT251	2 Switches	S9V2B060U3VSA	2
BAYHALT252	2 Switches	S9V2B080U4VSA, S9V2B080D4VSA, S9V2C100D4VSA	2
BAYHALT253	2 Switches	S9V2C100U4VSA	2
BAYHALT254	2 Switches	S9V2D120U5VSA	2

Convertible Gas Furnaces

Table FUR-3-A — Features

	S9V2-VS Variable Speed	S9V2 Variable Speed	S9X2 Multi-Speed
• Direct drive, variable speed ECM blower motor - Constant airflow ECM (electronically commutated motor) ..	✓	✓	✓
• Direct drive, multi speed ECM blower motor - Constant torque ECM (electronically commutated motor)	—	—	✓
• Variable speed draft inducer motor	✓	—	—
• Comfort-R™ enhanced mode (cooling).....	✓	✓	—
• Standard 34" height	✓	✓	✓
• 3 Way poise Upflow furnace model (Upflow, Horizontal Left, Horizontal Right)	✓	✓	✓
• Dedicated Downflow furnace model	✓	✓	✓
• Front service access with easily accessible burners, sensors, orifices, switches, and other components	✓	✓	✓
• Cabinet has no knockouts - Rubber and plastic plugs come installed from factory	✓	✓	✓
• Gas can enter either side of cabinet	✓	✓	✓
• Condensate can exit either side of cabinet in Upflow orientation	✓	✓	✓
• Multiple venting options - Every model, every size will offer two venting options	✓	✓	✓
• Integrated Furnace Control board with digital configuration, status, and fault codes	✓	✓	✓
• Alpha-numeric diagnostic codes	✓	✓	✓
• Dry contact Humidifier/EAC hook-up capability	✓	✓	✓
• Adjustable blower off delay for heating and cooling	✓	✓	✓
• Last six fault codes are stored (even with power loss)	✓	✓	✓
• Stainless steel primary and secondary heat exchanger tubes	✓	✓	✓
• Longer IFC wire harnesses allow door to be removed without disconnecting the harness	✓	✓	✓
• Alternate bottom/left/right return air (upflow models only)	✓	✓	✓
• Bottom panel	✓	✓	✓
• Dual PVC pipe venting (1 or 2 pipe option)	✓	✓	✓
• Two stage combination gas valve and regulator	✓	✓	✓
• Gasketed inner and outer door	✓	✓	✓
• Heavy gauge reinforced wrap-around steel cabinet	✓	✓	✓
• Insulated blower compartment	✓	✓	✓
• Left/right condensate drain capability in vertical application	✓	✓	✓
• Service diagnostics with faults reported on IFC board	✓	✓	✓
• Manual reset flame roll out switches	✓	✓	✓
• Mobile home approved with mobile home kit	✓	✓	✓
• Multi-port in shot burners	✓	✓	✓
• Painted cabinet two tone color	✓	✓	✓
• Service diagnostic capabilities	✓	✓	✓
• Vortica™ II blower housing	✓	✓	✓
• Slide out blower assembly on full-length rails	✓	✓	✓
• Side return duct starter tabs (upflow models only)	✓	✓	✓
• Silicon Nitride 120V hot surface igniter	✓	✓	✓
• Multiple heating blower speeds	✓	✓	✓
• Meets requirements for 1% or less air leakage	✓	✓	✓
• Limited lifetime heat exchanger warranty & 10-year on all other functional parts (Residential Use)	✓	✓	✓
• Optional extended warranties available	✓	✓	✓

Note: Variable speed furnaces should not be twinned and are not approved for twinning applications.

Table FUR-3-B — Optional Accessories

Model Number	Description	Shipping Weight	S9V2-VS 2 Stage 1 or 2 Pipe	S9V2 - 2 Stage 1 or 2 Pipe	S9X2 - 2 Stage 1 or 2 Pipe
BAYLPSS400B	LP Kit with Stainless Steel Burners	3	✓	✓	✓
BAYHANG	Horizontal hanging kit	2	✓	✓	✓
BAYVENT200B	Sidewall vent Termination Kit fo Direct vent furnaces	2	✓	✓	✓
BAYVENTCN200B	Sidewall vent Termination Kit fo Direct vent furnaces for Canadian applications2	2	✓	✓	✓
BAYAIR30AVENTA	Concentric vent kit for 2, 2½ and 3" vent system	11	✓	✓	✓
BAYAIR30CNVENT	Concentric vent kit for 2, 2½ and 3" vent system for Canadian applications . 11	11	✓	✓	✓
BAYREDUCE	Reducer Coupling for Canadian applications (CPVC).....	1	✓	✓	✓
BAYLIFTB.....	Dual return kit. B size extension	8	✓	✓	✓
BAYLIFTC.....	Dual return kit. C size extension	9	✓	✓	✓
BAYLIFTD.....	Dual return kit. D size extension	9	✓	✓	✓
BAYMFGH200B	Manufactured/mobile home kit	1	✓	✓	✓
BAYCNDTRAP2A.....	In-line condensate collector for 2" PVC pipe	1	✓	✓	✓
BAYCNDTRAP3A.....	In-line condensate collector for 3" PVC pipe	1	✓	✓	✓
BAYBASE205.....	Downflow subbase.....	8	✓	✓	✓
BAYFLTR206	Filter Access Door Kit (Downflow only)	2	✓	✓	✓
MAYBFERCOLKITA ①.....	Heat Shield, B size cabinet	3	✓	✓	✓
MAYCFERCOLKITA ①.....	Heat Shield, C size cabinet	3	✓	✓	✓
MAYDFERCOLKITA ①.....	Heat Shield, D size cabinet	3	✓	✓	✓
BAYSF1165	16x20 1" side return filter rack	✓	✓	✓
BAYSF1255	16x25 1" side return filter rack (bottom return for 17.5" cabinets)	✓	✓	✓
BAYBURNERS	Stainless steel natural gas burner kit	✓	✓	✓

① Required on furnaces manufactured on or after 7/3/19 (with date code 19273 or after) when installed with a 4MXC or 4GXC coils in upflow or horizontal position. Not required in Downflow orientation.

For complete equipment / combination selections, installation instructions and warranty information, please refer to Product Data/Ratings and/or Installers Guides and Limited Warranty Handbooks.

S9X1 – Single Stage High Efficiency ECM

Table FUR-4-A — S9X1 High Efficiency 9 Speed ECM Motor, 1 Stage, Direct/Non-Direct Vent, Upflow/Horizontal Left/Horizontal Right Condensing Gas Furnace (120/1/60)^③

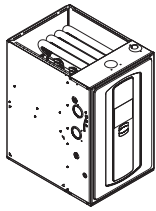

**S9X1
Direct Vent
Upflow**

Unit Model No.	Airflow In Tons	Nominal Output (BTUH)	ICS ^① AFUE	Flue Size (in)	Ignition Device	Uncrated Dimensions (in.) H x W x D	Shipping Weight (lbs.)	Max Fuse*	Filter Sizes**
S9X1B040U3PSBA	3	38,800	96.0 ^②	2, 3, 4	④	34 x 17 ¹ / ₂ x 28 ³ / ₄	122	15	16 x 25 x 1
S9X1B060U4PSBA	4	58,200	96.0 ^②	2, 3, 4	④	34 x 17 ¹ / ₂ x 28 ³ / ₄	130	15	16 x 25 x 1
S9X1B080U4PSBA	4	77,600	96.0 ^②	2, 3, 4	④	34 x 17 ¹ / ₂ x 28 ³ / ₄	135	15	16 x 25 x 1
S9X1C080U5PSBA	5	77,600	96.0 ^②	2, 3, 4	④	34 x 21 x 28 ³ / ₄	149	15	20 x 25 x 1
S9X1C100U5PSBA	5	97,000	95.0 ^②	2, 3, 4	④	34 x 21 x 28 ³ / ₄	155	15	20 x 25 x 1
S9X1D120U5PSBA	5	116,400	95.0 ^②	3, 4	④	34 x 24 ¹ / ₂ x 28 ³ / ₄	167	15	24 x 25 x 1

Table FUR-4-B — S9X1 High Efficiency 9 Speed ECM Motor, 1 Stage, Direct/Non-Direct Vent, Downflow Condensing Gas Furnace (120/1/60)^③

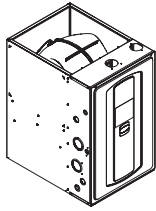

**S9X1
Direct Vent
Downflow**

Unit Model No.	Airflow In Tons	Nominal Output (BTUH)	ICS ^① AFUE	Flue Size (in)	Ignition Device	Uncrated Dimensions (in.) H x W x D	Shipping Weight (lbs.)	Max Fuse*	Filter Sizes**
S9X1B040D3PSBA	3	38,800	96.0 ^②	2, 3, 4	④	34 x 17 ¹ / ₂ x 28 ³ / ₄	122	15	(2)14 x 20 x 1
S9X1B060D3PSBA	3	58,200	96.0 ^②	2, 3, 4	④	34 x 17 ¹ / ₂ x 28 ³ / ₄	127	15	(2)14 x 20 x 1
S9X1B080D4PSBA	4	77,600	95.0 ^②	2, 3, 4	④	34 x 17 ¹ / ₂ x 28 ³ / ₄	135	15	(2)14 x 20 x 1
S9X1C100D5PSBA	5	97,000	96.0 ^②	2, 3, 4	④	34 x 21 x 28 ³ / ₄	155	15	(2)16 x 20 x 1
S9X1D120D5PSBA	5	116,400	95.0 ^②	3, 4	④	34 x 24 ¹ / ₂ x 28 ³ / ₄	167	15	(2)16 x 20 x 1

① Isolated Combustion System. AFUE may vary based on poise.

② Energy Star.

③ Direct drive 9 speed motor is a high efficiency constant torque ECM blower motor.

④ Silicon Nitride Igniter.

* Information subject to change. Please confirm with current Product Data/Service Facts for current factory production.

** Filters are not shipped with furnace. For Upflow furnaces, the size is for a bottom return filter.

S9B1 – Single Stage High Efficiency ECM

Table FUR-4-C — S9B1 High Efficiency 9 Speed ECM Motor, 1 Stage, Direct/Non-Direct Vent, Upflow/Horizontal Left/Horizontal Right Condensing Gas Furnace (120/1/60)^③

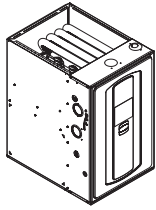

**S9B1
Direct Vent
Upflow**

Unit Model No.	Airflow In Tons	Nominal Output (BTUH)	ICS ^① AFUE	Flue Size (in)	Ignition Device	Uncrated Dimensions (in.) H x W x D	Shipping Weight (lbs.)	Max Fuse*	Filter Sizes**
S9B1B040U3PSAA	3	38,800	92.1 ^②	2, 3, 4	④	34 x 17 ¹ / ₂ x 28 ³ / ₄	122	15	16 x 25 x 1
S9B1B060U4PSAA	4	58,200	92.1 ^②	2, 3, 4	④	34 x 17 ¹ / ₂ x 28 ³ / ₄	130	15	16 x 25 x 1
S9B1B080U4PSAA	4	77,600	92.1 ^②	2, 3, 4	④	34 x 17 ¹ / ₂ x 28 ³ / ₄	135	15	16 x 25 x 1
S9B1C080U5PSAA	5	77,600	92.1 ^②	2, 3, 4	④	34 x 21 x 28 ³ / ₄	149	15	20 x 25 x 1
S9B1C100U5PSAA	5	97,000	92.1 ^②	2, 3, 4	④	34 x 21 x 28 ³ / ₄	155	15	20 x 25 x 1
S9B1D120U5PSAA	5	116,400	92.1 ^②	3, 4	④	34 x 24 ¹ / ₂ x 28 ³ / ₄	167	15	24 x 25 x 1

Table FUR-4-D — S9B1 High Efficiency 9 Speed ECM Motor, 1 Stage, Direct/Non-Direct Vent, Downflow Condensing Gas Furnace (120/1/60)^③

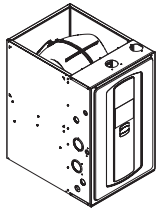

**S9B1
Direct Vent
Downflow**

Unit Model No.	Airflow In Tons	Nominal Output (BTUH)	ICS ^① AFUE	Flue Size (in)	Ignition Device	Uncrated Dimensions (in.) H x W x D	Shipping Weight (lbs.)	Max Fuse*	Filter Sizes**
S9B1B040D3PSAA	3	38,800	92.1 ^②	2, 3, 4	④	34 x 17 ¹ / ₂ x 28 ³ / ₄	122	15	(2)14 x 20 x 1
S9B1B060D3PSAA	3	58,200	92.1 ^②	2, 3, 4	④	34 x 17 ¹ / ₂ x 28 ³ / ₄	127	15	(2)14 x 20 x 1
S9B1B080D4PSAA	4	77,600	92.1 ^②	2, 3, 4	④	34 x 17 ¹ / ₂ x 28 ³ / ₄	135	15	(2)14 x 20 x 1
S9B1C100D5PSAA	5	97,000	92.1 ^②	2, 3, 4	④	34 x 21 x 28 ³ / ₄	155	15	(2)16 x 20 x 1
S9B1D120D5PSAA	5	116,400	92.1 ^②	3, 4	④	34 x 24 ¹ / ₂ x 28 ³ / ₄	167	15	(2)16 x 20 x 1

① Isolated Combustion System. AFUE may vary based on poise.

② Energy Star - U.S. South.

③ Direct drive 9 speed motor is a high efficiency constant torque ECM blower motor.

④ Silicon Nitride Igniter.

* Information subject to change. Please confirm with current Product Data/Service Facts for current factory production.

** Filters are not shipped with furnace. For Upflow furnaces, the size is for a bottom return filter.

Convertible Gas Furnaces

Furnaces

Table FUR-5-A — Features

	S9X1 Multi-Speed	S9B1 Multi-Speed
• Dry contact Humidifier/EAC hook-up capability.....	✓	—
• Insulated blower compartment.....	✓	—
• Meets requirements for 1% or less air leakage ①.....	✓	—
• Standard 34" height	✓	✓
• 3 Way poise Upflow furnace model (Upflow, Horizontal Left, Horizontal Right).....	✓	✓
• Dedicated Downflow furnace model.....	✓	✓
• Front service access with easily accessible burners, sensors, orifices, switches, and other components	✓	✓
• Cabinet has no knockouts - Rubber and plastic plugs come installed from factory.....	✓	✓
• Gas can enter either side of cabinet	✓	✓
• Condensate can exit either side of cabinet in Upflow orientation.....	✓	✓
• Multiple venting options - Every model, every size will offer two venting options.....	✓	✓
• Integrated Furnace Control board with digital configuration, status, and fault codes.....	✓	✓
• Alpha-numeric diagnostic codes.....	✓	✓
• Adjustable blower off delay for heating and cooling.....	✓	✓
• Last six fault codes are stored (even with power loss)	✓	✓
• Stainless steel primary and secondary heat exchanger tubes.....	✓	✓
• Longer IFC wire harnesses allow door to be removed without disconnecting the harness	✓	✓
• Alternate bottom/left/right return air (upflow models only)	✓	✓
• Bottom panel	✓	✓
• Direct drive, 9 speed ECM blower motor - Constant torque ECM (electronically commutated motor)	✓	✓
• Dual PVC pipe venting (1 or 2 pipe option)	✓	✓
• Single-stage combination gas valve and regulator.....	✓	✓
• Gasketed inner and outer door.....	✓	✓
• Heavy gauge reinforced wrap-around steel cabinet	✓	✓
• Left/right condensate drain capability in vertical application	✓	✓
• Service diagnostics with faults reported on IFC board.....	✓	✓
• Manual reset flame roll out switches.....	✓	✓
• Mobile home approved with mobile home kit.....	✓	✓
• Multi-port in shot burners.....	✓	✓
• Service diagnostic capabilities.....	✓	✓
• Vortica™ II blower housing	✓	✓
• Slide out blower assembly on full-length rails.....	✓	✓
• Side return duct starter tabs (upflow models only)	✓	✓
• Silicon Nitride 120V hot surface igniter	✓	✓
• Multiple heating blower speeds.....	✓	✓
• Limited lifetime heat exchanger warranty & 10-year on all other functional parts (Residential Use)	✓	✓
• Optional extended warranties available	✓	✓

① 1.4% on S9B1 models.

Table FUR-5-B — Optional Accessories

Model Number	Description	Shipping Weight	S9X1 - 1 Stage 1 or 2 Pipe	S9B1 - 1 Stage 1 or 2 Pipe
BAYLPSS400B	LP Kit with Stainless Steel Burners.....	3	✓	✓
BAYHANG	Horizontal hanging kit.....	2	✓	✓
BAYVENT200B	Sidewall vent Termination Kit fo Direct vent furnaces.....	2	✓	✓
BAYVENTCN200B	Sidewall vent Termination Kit fo Direct vent furnaces for Canadian applications.....	2	✓	✓
BAYAIR30AVENTA	Concentric vent kit for 2, 2½ and 3" vent system	11	✓	✓
BAYAIR30CNVENT	Concentric vent kit for 2, 2½ and 3" vent system for Canadian applications	11	✓	✓
BAYREDUCE	Reducer Coupling for Canadian applications (CPVC).....	1	✓	✓
BAYLIFTB.....	Dual return kit. B size extension	8	✓	✓
BAYLIFTC.....	Dual return kit. C size extension	9	✓	✓
BAYLIFTD.....	Dual return kit. D size extension	9	✓	✓
BAYMFGH200B	Manufactured/mobile home kit	1	✓	✓
BAYCNDTRAP2A.....	In-line condensate collector for 2" PVC pipe	1	✓	✓
BAYCNDTRAP3A.....	In-line condensate collector for 3" PVC pipe	1	✓	✓
BAYBASE205.....	Downflow subbase.....	8	✓	✓
BAYFLTR206.....	Filter Access Door Kit (Downflow only)	2	✓	✓
MAYBFERCOLKITA ②.....	Heat Shield, B size cabinet	3	✓	✓
MAYCFERCOLKITA ②.....	Heat Shield, C size cabinet	3	✓	✓
MAYDFERCOLKITA ②.....	Heat Shield, D size cabinet	3	✓	✓
BAYSF1165	16x20 1" side return filter rack	✓	✓	✓
BAYSF1255	16x25 1" side return filter rack (bottom return for 17.5" cabinets)	✓	✓	✓
BAYBURNERSS	Stainless steel natural gas burner kit	✓	✓	✓

② Required on furnaces manufactured on or after 7/3/19 (with date code 19273 or after) when installed with a 4MXC or 4GXC coils in upflow or horizontal position. Not required in Downflow orientation.

For complete equipment / combination selections, installation instructions and warranty information, please refer to Product Data/Ratings and/or Installers Guides and Limited Warranty Handbooks.

Platinum 95, Silver 95h, Silver 95, and American Standard 92 Convertible Gas Furnaces Airflow Directions

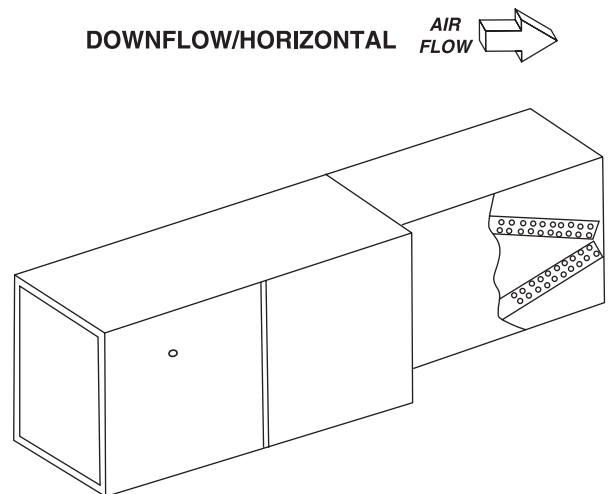
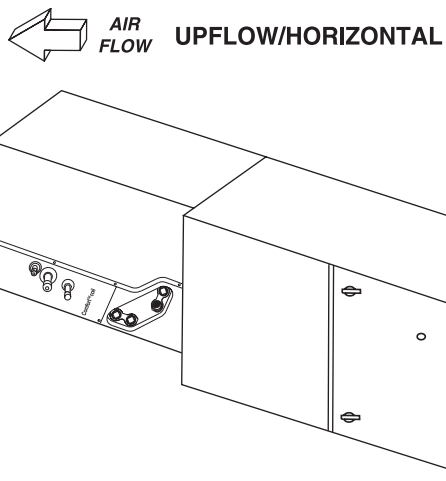
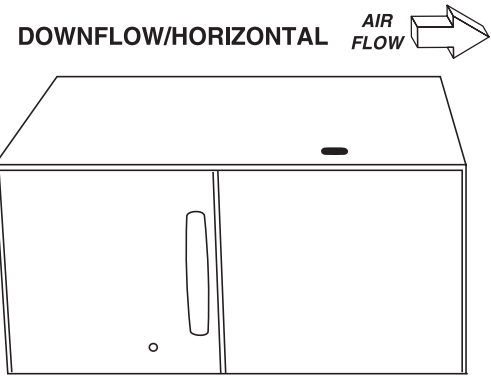
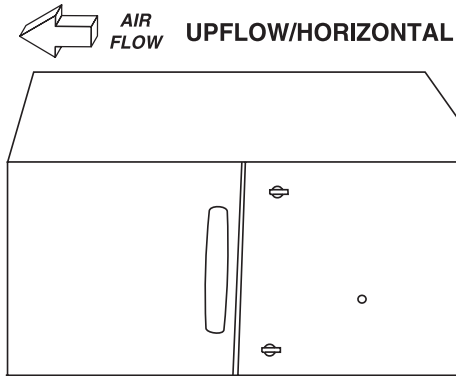
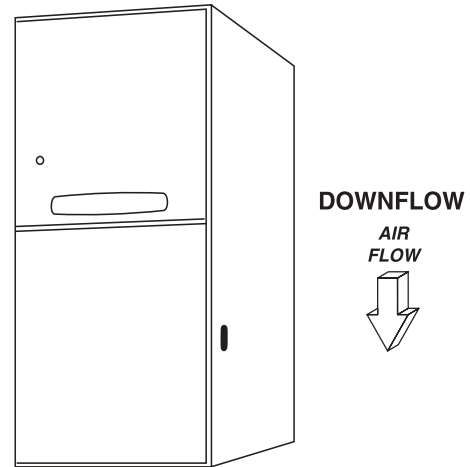
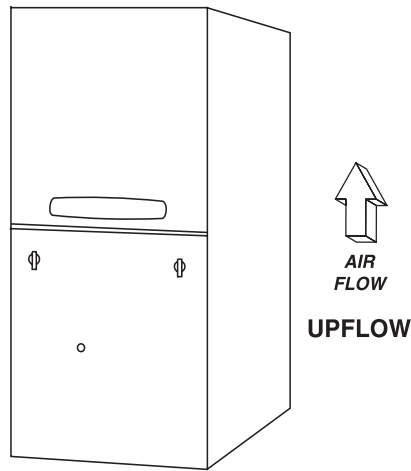

Note: The forty inch (40") height condensing downflow/horizontal and upflow/horizontal furnaces may only be rotated onto their left side. Connection brackets for coil/furnace alignment are included with the furnaces. The apex of the coil may point into or away from the airflow.

Platinum 95 – Modulating, Communicating ECM Variable Speed

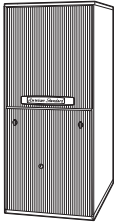

**Platinum 95
Direct/Non-Direct
Vent Upflow**

**Table FUR-7-A — Platinum 95 Variable Speed, Communicating, Modulating Direct/Non-Direct Vent, Upflow/
Horizontal Left Condensing Gas Furnace (115/1/60)④⑤⑦**

Unit Model No.	Airflow In Tons	Output (Btuh)			ICS① AFUE Upflow / Horiz	Flue Size (in)	Uncrated Dimensions (in.) H x W x D	Shipping Weight (lbs.)	Max Fuse*	Filter Sizes**
		High Stage 100%	Low Stage 40%③	High Stage 100%						
AUHMB060ACV3VB	3	57,000	23,000	97.3② / 96.5②	2, 2½, 3	40 x 17½ x 28	158	15	17 x 25 x 1	
AUHMB080ACV3VB	3	76,000	31,000	97.0② / 96.2②	2, 2½, 3	40 x 17½ x 28	168	15	17 x 25 x 1	
AUHMC100ACV4VB	4	95,000	39,000	96.0② / 95.2②	2½, 3	40 x 21 x 28	197	15	20 x 25 x 1	
AUHMD120ACV5VB	5	114,000	52,000	97.0② / 96.2②	3	40 x 24½ x 28	206	15	24 x 25 x 1	



**Platinum 95
Direct/Non-Direct
Vent Downflow**

**Table FUR-7-B — Platinum 95 Variable Speed, Communicating Modulating Direct/Non-Direct Vent,
Downflow/Horizontal Right Condensing Gas Furnace (115/1/60)④⑤⑦**

Unit Model No.	Airflow In Tons	Output (Btuh)			ICS① AFUE	Flue Size (in)	Ignition Device	Uncrated Dimensions (in.) H x W x D	Shipping Weight (lbs.)	Max Fuse*	Filter Sizes
		High Stage 100%	Low Stage 40%	High Stage 100%							
ADHMB060BCV3VB	3	57,000	22,800	95.0②	2, 2½, 3	⑥	40 x 17½ x 28	160	15	(2)14 x 20 x 1	
ADHMB080ACV3VB	3	76,000	30,400	96.0②	2, 2½, 3	⑥	40 x 17½ x 28	168	15	(2)14 x 20 x 1	
ADHMC100ACV4VB	4	96,000	38,400	96.0②	2½, 3	⑥	40 x 21 x 28	185	15	(2)16 x 20 x 1	
ADHMD120BCV5VB	5	114,000	51,300	95.0②	3	⑥	40 x 24½ x 28	206	15	(2)16 x 20 x 1	

Note: Variable speed furnaces should not be twinned and are not approved for twinning applications

① Isolated Combustion System. AFUE may vary based on poise.

② Energy Star.

③ Low stage is equal to 45% for AUHMD120 model.

④ Furnace use in 24, non-communicating mode.

⑤ Direct drive variable speed motor is an ECM constant airflow blower motor.

⑥ Silicon Nitride

⑦ Must use communicating thermostat with AccuLink™ II control.

* Information subject to change. Please confirm with current Product Data/Service Facts for current factory production.

** For Upflow furnaces, the size is for a bottom return filter.

Platinum 95, Convertible Gas Furnaces

Airflow Directions:

Downflow models when placed in horizontal position provide left to right airflow. Upflow models when placed in horizontal position provide right to left airflow.

Table FUR-8-A — Features

	AUHM ADHM Modulating 1 or 2 Pipe Variable Speed
• Comfort-R™ enhanced mode (cooling).....	✓
• AccuLink™ II system①.....	✓
• Meets requirements for 2% or less air leakage.....	✓
• Adjustable heating fan off timing.....	✓
• Alternate bottom/left/right return air (upflow models only).....	✓
• Blower door safety switch.....	✓
• Bottom panel (upflow models only).....	✓
• Cleanable/Reusable high velocity filters.....	✓
• Complete front service access.....	✓
• Direct drive, variable speed ECM blower motor**.....	✓
• Downflow horizontal right (downflow models only).....	✓
• Dual PVC pipe venting (1 or 2 pipe option).....	✓
• Modulating gas valve and regulator.....	✓
• Gasketed blower door (upflow models only).....	✓
• Heavy gauge reinforced wrap-around steel cabinet.....	✓
• Humidifier/EAC hook-up capability.....	✓
• Inner blower door panel (downflow models only).....	✓
• Insulated blower compartment 4 sides.....	✓
• Integrated solid state control w/self diagnostics.....	✓
• Left/right condensate drain capability in vertical application.....	✓
• Service diagnostics with faults reported at the user interface.....	✓
• Lite Port™/Stored diagnostics.....	✓
• Manual reset flame roll out switches.....	✓
• Multi-port in shot burners.....	✓
• Painted cabinet two tone color.....	✓
• Service diagnostic capabilities.....	✓
• Side return duct starter tabs (upflow models only).....	✓
• Silicon Nitride hot surface igniter.....	✓
• Slide out blower assembly.....	✓
• Solid burner door (quiet operation).....	✓
• 20 gauge aluminized steel heat exchanger.....	✓
• 24 volt secondary fuse.....	✓
• Multiple heating blower speeds.....	✓
• Type 29-4C™ stainless steel secondary heat exchanger.....	✓
• Upflow horizontal left (upflow models only).....	✓
• Variable speed venter motor.....	✓
• Limited lifetime heat exchanger warranty & 10-year on all other functional parts (Residential Use)	✓
• Optional extended warranties available	✓

Note: Variable speed furnaces should not be twinned and are not approved for twinning applications.

① Field configurable to 24V non-communicating mode.

*Constant torque ECM (electronically commutated motor).

**Constant airflow ECM (electronically commutated motor).

Furnaces

Platinum 95, Convertible Gas Furnace

Airflow Directions:

Downflow models when placed in horizontal position provide left to right airflow. Upflow models when placed in horizontal position provide right to left airflow.

Table FUR-9-A — Optional Accessories

Model Number	Description	Shipping Weight	AUHM/ADHM Modulating 1 or 2 Pipe Variable Speed
BAYBASE205	Downflow subbase for downflow models only	8	✓
BAYFLTR200	External side filter rack	5	✓
BAYFLTR203	Filter kit horiz conversion for 17.5" cabinet	3	✓
BAYFLTR204	Filter kit horiz conversion for 21" cabinet	3	✓
BAYFLTR205	Filter kit horiz conversion for 24.5" cabinet	3	✓
BAYFLTR317 ^①	Cleanable filter for 17.5" cabinet upflow only	2	✓
BAYFLTR321 ^①	Cleanable filter for 21" cabinet upflow only	2	✓
BAYFLTR324 ^①	Cleanable filter for 24.5" cabinet upflow only	2	✓
BAYLPKT220B	Propane conversion kit	2	✓
BAYLPSS220C	LP Kit with Stainless Steel Burners	2	✓
BAYRACK960A ^③	Filter rack kit for upflow models only (internal) ^②	5	✓
BAYAIR30AVENTA	Concentric vent kit for 2, 2½ and 3" vent system	11	✓
BAYAIR30CNVENT	Concentric vent kit for 2, 2½ and 3" vent system for Canadian applications	11	✓
BAYVENT200B	Sidewall vent Termination Kit fo Direct vent furnaces	2	✓
BAYVENTCN200B	Sidewall vent Termination Kit fo Direct vent furnaces for Canadian applications	2	✓
BAYVENT500A	Side vent kit for downflow models only	3	ADHM
BAYACCECOMM101	AccuClean™ hookup kit for communicating furnaces	1	✓

Note: Variable speed furnaces should not be twinned and are not approved for twinning applications.

① Contains one (1) high velocity filter.

② Internal filter rack for side or bottom return air. Includes 17 x 25" cleanable filter for use in side return applications. Bottom return applications require different sizes of filters which are not included. Airflow requirements over 1800 CFM require filters on both sides or a side and bottom or bottom only.

③ BAYRACK960A not allowed on right side return on AUH2B080A9V4V** models.

Furnaces

Airflow Directions:

Downflow models when placed in horizontal position provide left to right airflow. Upflow models when placed in horizontal position provide right to left airflow.

Table FUR-9-B — Optional Accessories

Model Number	Description	Shipping Weight	AUH1-H/ ADH1-H 2 Stage 1 or 2 Pipe	AUH1/ADH1/ AUX1/ADX1 1 Stage 1 or 2 Pipe	AUC1/ADC1 1 Stage 1 or 2 Pipe
BAYBASE205	Downflow subbase for downflow models only	8	✓	✓	✓
BAYFLTR200	External side filter rack	5	✓	✓	✓
BAYFLTR203	Filter kit horiz conversion for 17.5" cabinet	3	✓	✓	✓
BAYFLTR204	Filter kit horiz conversion for 21" cabinet	3	✓	✓	✓
BAYFLTR205	Filter kit horiz conversion for 24.5" cabinet	3	✓	✓	✓
BAYFLTR206	Filter access door kit (Downflow only)	2	✓	✓	✓
BAYFLTR317 ^①	Cleanable filter for 17.5" cabinet upflow only	2	✓	✓	✓
BAYFLTR321 ^①	Cleanable filter for 21" cabinet upflow only	2	✓	✓	✓
BAYFLTR324 ^①	Cleanable filter for 24.5" cabinet upflow only	2	✓	✓	✓
BAYLPKT210B	Propane conversion kit	1	✓	✓	✓
BAYLPSS210B	LP Kit with Stainless Steel Burners	1	✓	✓	✓
BAYMFGH100A	Manufactured/mobil home kit	2	✓	✓	✓
BAYRACK960A	Filter rack kit for upflow models only (internal) ^②	5	✓	✓	✓
BAYAIR30AVENTA	Concentric vent kit for 2, 2½ and 3" vent system	11	✓	✓	✓
BAYAIR30CNVENT	Concentric vent kit for 2, 2½ and 3" vent system for Canadian applications	11	✓	✓	✓
BAYVENT200B	Sidewall vent Termination Kit fo Direct vent furnaces	2	✓	✓	✓
BAYVENTCN200B	Sidewall vent Termination Kit fo Direct vent furnaces for Canadian applicat	2	✓	✓	✓
BAYVENT500A	Side vent kit for downflow models only	3	✓	✓	✓

Note: Variable speed furnaces should not be twinned and are not approved for twinning applications.

① Contains one (1) high velocity filter.

② Internal filter rack for side or bottom return air. Includes 17 x 25" cleanable filter for use in side return applications. Bottom return applications require different sizes of filters which are not included. Airflow requirements over 1800 CFM require filters on both sides or a side and bottom or bottom only.

Special Use Furnace Accessories

Table FUR-10-A — High Altitude Pressure Switch 90%

Model Number	Description	Used With	Shipping Weight
BAYHALT225	1 Switch	AUC080,100C948,120C,ADC080,120C	2
BAYHALT226	1 Switch	AUC,ADC060C	2
BAYHALT227	1 Switch	AUC100C948	2
BAYHALT228	1 Switch	AUC/ADC040C	2
BAYHALT230	1 Switch	AUX/ADX040C,AUX1B040,D100/ADX1B040	2
BAYHALT231	1 Switch	AUX060C,AUX1060C	2
BAYHALT232	1 Switch	AUX080C,AUX1B080C	2
BAYHALT233	1 Switch	AUX100,120C/ADX080,120C,AUX1C100,D120/ADX1B080,D120	2
BAYHALT234	1 Switch	ADX100C,ADX1C100	2
BAYHALT241	1 Switch	ADX060C,ADX1B060	2
BAYHALT245	2 Switches	ADX/AUX/ADY/AUY060-R	2
BAYHALT246	2 Switches	ADX/AUX/ADY/AUY080,100-R	2
BAYHALT247	2 Switches	ADX/AUX/ADY/AUY120-R	2
BAYHALT248	1 Switch	AUD1/ADD1,AUE1/ADE	2
BAYHALT249	1 Switch	AUD2,AUD-R-K,ADD-R-F,ADD2	2

Table FUR-10-B — High Altitude Pressure Switch 90%

Model Number	Description	Used With	Shipping Weight
BAYSWT01AHALTA	1 Switch	AUC1B040,AUC1D100,ADC1B040,AUX1B040, AUX1D100,ADX1B040,AUH1B040,ADH1B040,ADH1C085	2
BAYSWT02AHALTA	1 Switch	AUC1B060,AUX1B060	2
BAYSWT03AHALTA	1 Switch	AUC1B080,AUX1B080	2
BAYSWT04AHALTA	1 Switch	AUC1C100,AUC1D120,ADC1B080, ADC1C100,ADC1D120,AUX1C100,AUX1D120, ADX1B080,ADX1D120,AUH1B060, AUH1D100, AUH1D120	2
BAYSWT05AHALTA	1 Switch	ADX1C100,AUH1B080,AUH1C100,ADH1D110	2
BAYSWT06AHALTA	1 Switch	ADC1B060,ADX1B060	2
BAYSWT07AHALTA	1 Switch	AUH3/AUHMB060,ADH3/ADHMB060,AUX2B060,ADX2B060, AUY060R,ADY060R	2
BAYSWT08AHALTA	1 Switch	AUX2B080,AUX2C100,ADX2B080,ADX2C100,AUY120R,ADY120R, AUH2B080,ADH2B080,AUH2C100,ADH2C100,AUH2D120, ADH2D120,AUH3/AUHMD120,ADH3/ADHMD120	2
BAYSWT09AHALTA	1 Switch	AUX2D120,ADX2D120,AUY080R,ADY080R,AUY100R, ADY100R,AUH3/AUHMB080,ADH3/ADHMB080,AUH3/AUHMC100, ADH/ADHM3C100	2
BAYSWT10AHALTA	1 Switch	AUH2B060A,ADH2B060A	2
BAYSWT11AHALTA	1 Switch	AUH1C080	2
BAYSWT12AHALTA	1 Switch	ADH1B065	2
BAYSWT01AMALTB	1 Switch	AUX1	2

The following changes occurred beginning with serial number 6151:

1. All 2 stage furnace changed from two separate pressure switches to one piggy back switch.
2. The high altitude pressure switches are now piggy back.
3. The new piggy back switches are not interchangeable with the original two switch design.
4. The pressure switch mounting plate is different for the piggy back switches.

S8X2 – Two Stage ECM

Table FUR-11-A — S8X2 2 Stage, Upflow/Downflow/Horizontal Left/Horizontal Right, Non-Condensing, Induced Draft Gas Furnace (120/1/60)^②

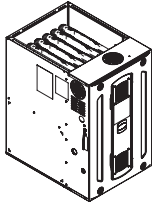

**S8X2
4-Way
Multi-Poise**

Unit Model No.	Airflow In Tons	Output (Btuh)		ICS ^① AFUE	Flue Size (in)	Ignition Device	Uncrated Dimensions (in.) H x W x D	Shipping Weight (lbs.)	Max Fuse*	Filter Sizes**
		Stage 2	Stage 1							
S8X2A040M3PSAA	2-3	32,000	20,800	80.0	4	③	34 x 14 ¹ / ₂ x 28 ³ / ₄	102	15	14 x 25 x 1
S8X2B060M3PSAA	3	48,000	31,200	80.0	4	③	34 x 17 ¹ / ₂ x 28 ³ / ₄	130	15	16 x 25 x 1
S8X2B060M4PSAA	4	48,000	31,200	80.0	4	③	34 x 17 ¹ / ₂ x 28 ³ / ₄	132	15	16 x 25 x 1
S8X2B080M4PSAA	3-4	64,000	41,600	80.0	4	③	34 x 17 ¹ / ₂ x 28 ³ / ₄	137	15	16 x 25 x 1
S8X2C080M5PSAA	4-5	64,000	41,600	80.0	4	③	34 x 21 x 28 ³ / ₄	142	15	20 x 25 x 1
S8X2C100M5PSAA	4-5	80,000	52,000	80.0	4	③	34 x 21 x 28 ³ / ₄	144	15	20 x 25 x 1
S8X2D120M5PSAA	5	96,000	67,200	80.0	4	③	34 x 24 ¹ / ₂ x 28 ³ / ₄	160	15	24 x 25 x 1
Low NOx Models ^④										
S8X2A040M3PTAA	2-3	32,000	20,800	80.0	4	③	34 x 14 ¹ / ₂ x 28 ³ / ₄	102	15	14 x 25 x 1
S8X2B060M3PTAA	3	48,000	31,200	80.0	4	③	34 x 17 ¹ / ₂ x 28 ³ / ₄	130	15	16 x 25 x 1
S8X2B060M4PTAA	4	48,000	31,200	80.0	4	③	34 x 17 ¹ / ₂ x 28 ³ / ₄	132	15	16 x 25 x 1
S8X2B080M4PTAA	3-4	64,000	41,600	80.0	4	③	34 x 17 ¹ / ₂ x 28 ³ / ₄	137	15	16 x 25 x 1
S8X2C080M5PTAA	4-5	64,000	41,600	80.0	4	③	34 x 21 x 28 ³ / ₄	142	15	20 x 25 x 1
S8X2C100M5PTAA	4-5	80,000	52,000	80.0	4	③	34 x 21 x 28 ³ / ₄	144	15	20 x 25 x 1
S8X2D120M5PTAA	5	96,000	67,200	80.0	4	③	34 x 24 ¹ / ₂ x 28 ³ / ₄	160	15	24 x 25 x 1

① Isolated Combustion System.

② 9 Speed direct drive motor is an ECM constant torque motor.

③ Silicon Nitride Igniter.

④ These models comply with California 40ng/J Low NOx regulations.

* Information subject to change. Please confirm with current Product Data/Service Facts for current factory production.

** Filters are not shipped with furnace.

S8X1 – Single Stage ECM

Table FUR-11-B — S8X1 1 Stage, Upflow/Downflow/Horizontal Left/Horizontal Right, Non-Condensing, Induced Draft Gas Furnace (120/1/60)^②

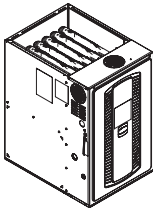

**S8X1
4-Way
Multi-Poise**

Unit Model No.	Airflow In Tons	Nominal Output (Btuh)	ICS ^① AFUE	Flue Size (in)	Ignition Device	Uncrated Dimensions (in.) H x W x D	Shipping Weight (lbs.)	Max Fuse*	Filter Sizes**	
										S8X1A026M2PSAA
S8X1A040M3PSAA	2-3	32,000	80.0	4	③	34 x 14 ¹ / ₂ x 28 ³ / ₄	102	15	14 x 25 x 1	
S8X1B040M2PSAA	2	32,000	80.0	4	③	34 x 17 ¹ / ₂ x 28 ³ / ₄	128	15	16 x 25 x 1	
S8X1B060M3PSAA	3	48,000	80.0	4	③	34 x 17 ¹ / ₂ x 28 ³ / ₄	130	15	16 x 25 x 1	
S8X1B060M4PSAA	4	48,000	80.0	4	③	34 x 17 ¹ / ₂ x 28 ³ / ₄	132	15	16 x 25 x 1	
S8X1B080M4PSAA	3-4	64,000	80.0	4	③	34 x 17 ¹ / ₂ x 28 ³ / ₄	137	15	16 x 25 x 1	
S8X1C080M5PSAA	4-5	64,000	80.0	4	③	34 x 21 x 28 ³ / ₄	142	15	20 x 25 x 1	
S8X1C100M5PSAA	4-5	80,000	80.0	4	③	34 x 21 x 28 ³ / ₄	144	15	20 x 25 x 1	
S8X1D120M5PSAA	5	96,000	80.0	4	③	34 x 24 ¹ / ₂ x 28 ³ / ₄	160	15	24 x 25 x 1	
Low NOx Models ^④										
S8X1A026M2PTAA	2	20,800	80.0	4	③	34 x 14 ¹ / ₂ x 28 ³ / ₄	102	15	14 x 25 x 1	
S8X1A040M3PTAA	2-3	32,000	80.0	4	③	34 x 14 ¹ / ₂ x 28 ³ / ₄	102	15	14 x 25 x 1	
S8X1B040M2PTAA	2	32,000	80.0	4	③	34 x 17 ¹ / ₂ x 28 ³ / ₄	128	15	16 x 25 x 1	
S8X1B060M3PTAA	3	48,000	80.0	4	③	34 x 17 ¹ / ₂ x 28 ³ / ₄	130	15	16 x 25 x 1	
S8X1B060M4PTAA	4	48,000	80.0	4	③	34 x 17 ¹ / ₂ x 28 ³ / ₄	132	15	16 x 25 x 1	
S8X1B080M4PTAA	3-4	64,000	80.0	4	③	34 x 17 ¹ / ₂ x 28 ³ / ₄	137	15	16 x 25 x 1	
S8X1C080M5PTAA	4-5	64,000	80.0	4	③	34 x 21 x 28 ³ / ₄	142	15	20 x 25 x 1	
S8X1C100M5PTAA	4-5	80,000	80.0	4	③	34 x 21 x 28 ³ / ₄	144	15	20 x 25 x 1	
S8X1D120M5PTAA	5	96,000	80.0	4	③	34 x 24 ¹ / ₂ x 28 ³ / ₄	160	15	24 x 25 x 1	

① Isolated Combustion System.

② 9 Speed direct drive motor is an ECM constant torque motor.

③ Silicon Nitride Igniter.

④ These models comply with California 40ng/J Low NOx regulations.

* Information subject to change. Please confirm with current Product Data/Service Facts for current factory production.

** Filters are not shipped with furnace.

S8B1 – Single Stage ECM

Table FUR-12-A — S8B1 1 Stage, Upflow/Downflow/Horizontal Left/Horizontal Right, Non-Condensing, Induced Draft Gas Furnace (120/1/60)^②

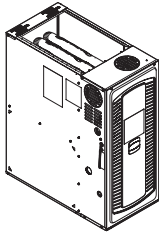

**S8B1
4-Way
Multi-Poise**

Unit Model No.	Airflow In Tons	Nominal Output (Btuh)	ICS ^① AFUE	Flue Size (in)	Ignition Device	Uncrated Dimensions (in.) H x W x D	Shipping Weight (lbs.)	Max Fuse [*]	Filter Sizes ^{**}
S8B1A026M2PSAA	2	20,800	80.0	4	③	34 x 14 ¹ / ₂ x 28 ³ / ₄	102	15	14 x 25 x 1
S8B1A040M3PSAA	2-3	32,000	80.0	4	③	34 x 14 ¹ / ₂ x 28 ³ / ₄	102	15	14 x 25 x 1
S8B1B040M2PSAA	2	32,000	80.0	4	③	34 x 17 ¹ / ₂ x 28 ³ / ₄	128	15	16 x 25 x 1
S8B1B060M3PSAA	3	48,000	80.0	4	③	34 x 17 ¹ / ₂ x 28 ³ / ₄	130	15	16 x 25 x 1
S8B1B060M4PSAA	4	48,000	80.0	4	③	34 x 17 ¹ / ₂ x 28 ³ / ₄	132	15	16 x 25 x 1
S8B1B080M4PSAA	3-4	64,000	80.0	4	③	34 x 17 ¹ / ₂ x 28 ³ / ₄	137	15	16 x 25 x 1
S8B1C080M5PSAA	4-5	64,000	80.0	4	③	34 x 21 x 28 ³ / ₄	142	15	20 x 25 x 1
S8B1C100M5PSAA	4-5	80,000	80.0	4	③	34 x 21 x 28 ³ / ₄	144	15	20 x 25 x 1
S8B1D120M5PSAA	5	96,000	80.0	4	③	34 x 24 ¹ / ₂ x 28 ³ / ₄	160	15	24 x 25 x 1
Low NOx Models ^④									
S8B1A026M2PTAA	2	20,800	80.0	4	③	34 x 14 ¹ / ₂ x 28 ³ / ₄	102	15	14 x 25 x 1
S8B1A040M3PTAA	2-3	32,000	80.0	4	③	34 x 14 ¹ / ₂ x 28 ³ / ₄	102	15	14 x 25 x 1
S8B1B040M2PTAA	2	32,000	80.0	4	③	34 x 17 ¹ / ₂ x 28 ³ / ₄	128	15	16 x 25 x 1
S8B1B060M3PTAA	3	48,000	80.0	4	③	34 x 17 ¹ / ₂ x 28 ³ / ₄	130	15	16 x 25 x 1
S8B1B060M4PTAA	4	48,000	80.0	4	③	34 x 17 ¹ / ₂ x 28 ³ / ₄	132	15	16 x 25 x 1
S8B1B080M4PTAA	3-4	64,000	80.0	4	③	34 x 17 ¹ / ₂ x 28 ³ / ₄	137	15	16 x 25 x 1
S8B1C080M5PTAA	4-5	64,000	80.0	4	③	34 x 21 x 28 ³ / ₄	142	15	20 x 25 x 1
S8B1C100M5PTAA	4-5	80,000	80.0	4	③	34 x 21 x 28 ³ / ₄	144	15	20 x 25 x 1
S8B1D120M5PTAA	5	96,000	80.0	4	③	34 x 24 ¹ / ₂ x 28 ³ / ₄	160	15	24 x 25 x 1

① Isolated Combustion System.

② 9 Speed direct drive motor is an ECM constant torque motor.

③ Silicon Nitride Igniter.

④ These models comply with California 40ng/J Low NOx regulations.

* Information subject to change. Please confirm with current Product Data/Service Facts for current factory production.

** Filters are not shipped with furnace.

Furnaces

Convertible Gas Furnaces

Table FUR-12-B — High Altitude Pressure Switch S8 Furnaces

Model Number	Description	Used With	Shipping Weight
BAYSWT14AHALTB	1 Switch	S8X1C080M5PSAA ^① , S8X1C100M5PSAA ^① S8B1C080M5PSAA ^① , S8B1C100M5PSAA ^①	2
BAYSWT15AHALTA	1 Switch	S8X1B060M3PSAA ^① , S8X1B060M4PSAA ^① S8X1B080M4PSAA ^① , S8B1B060M3PSAA ^① S8B1B060M4PSAA ^① , S8B1B080M4PSAA ^①	2
BAYSWT16AHALTA	2 Switches	S8X2C080M5PSAA ^①	2
BAYSWT17AHALTA	2 Switches	S8X2B060M3PSAA, S8X2B060M4PSAA	2
BAYSWT18AHALTA	2 Switches	S8X2B080M4PSAA ^①	2
BAYSWT19AHALTA	2 Switches	S8X2C100M5PSAA ^①	2
BAYSWT20AHALTA	1 Switch	S8X1A026M2PSAA ^① , S8B1A026M2PSAA ^①	2
BAYSWT21AHALTA	1 Switch	S8X1A040M3PSAA ^① , S8X1A040M3PSAA ^① S8X1B040M2PSAA ^① , S8B1B040M2PSAA ^①	2
BAYSWT22AHALTA	2 Switches	S8X2A040M3PSAA ^①	2
BAYSWT23AHALTA	2 Switches	S8X2B060M3PSAA ^② , S8X2B060M4PSAA ^②	2

Note: S8X1D120M5, S8B1D120M5 and S8X2D120M5 do not require high altitude pressure switch kits.

① SAAA & later or TAAA & later

② SAAB & later or TAAA & later

Convertible Gas Furnaces

Furnaces

Table FUR-13-A — Features

	S8X2 2 Stage	S8X1 1 Stage	S8B1 1 Stage
• Two stage combination gas valve and regulator	✓	—	—
• Dry contact Humidifier/EAC hook-up capability	✓	✓	—
• Insulated blower compartment ①	✓	✓	—
• Meets requirements for 1% or less air leakage ②	✓	✓	—
• Painted cabinet two tone color	✓	✓	—
• Standard 34" height	✓	✓	✓
• 4 Way poise (Upflow, Downflow, Horizontal Left, Horizontal Right)	✓	✓	✓
• Front service access with easily accessible burners, sensors, orifices, switches, and other components	✓	✓	✓
• Cabinet has no knockouts - Plastic plugs come installed from factory	✓	✓	✓
• Gas can enter either side of cabinet	✓	✓	✓
• Multiple venting options - Every model, every size offers two venting options	✓	✓	✓
• Integrated Furnace Control board with digital configuration, status, and fault codes	✓	✓	✓
• Alpha-numeric diagnostic codes	✓	✓	✓
• Adjustable blower off delay for heating and cooling	✓	✓	✓
• Last six fault codes are stored (even with power loss)	✓	✓	✓
• Aluminized heat exchanger tubes	✓	✓	✓
• Longer IFC wire harnesses allow door to be removed without disconnecting the harness	✓	✓	✓
• Alternate bottom/left/right return air (except downflow)	✓	✓	✓
• Bottom panel	✓	✓	✓
• Direct drive, 9 speed Constant Torque ECM blower motor	✓	✓	✓
• Heavy gauge reinforced wrap-around steel cabinet	✓	✓	✓
• Service diagnostics with faults reported on IFC board	✓	✓	✓
• Manual reset flame roll out switches	✓	✓	✓
• Multi-port in shot burners	✓	✓	✓
• Service diagnostic capabilities	✓	✓	✓
• Vortica™ II blower housing	✓	✓	✓
• Slide out blower assembly on full-length rails	✓	✓	✓
• Side return duct starter tabs	✓	✓	✓
• Silicon Nitride 120V hot surface igniter	✓	✓	✓
• Multiple heating blower speeds	✓	✓	✓
• 20-year limited warranty on the heat exchanger & 10-year on all other functional parts (Residential Use)	✓	✓	✓
• Optional extended warranties available	✓	✓	✓

① 14.5" cabinets do not have blower compartment insulation

② 1.4% leakage on S8B1 models

Table FUR-13-B — Optional Accessories

Model Number	Description	Shipping Weight	S8X2 2 Stage	S8X1 1 Stage	S8B1 1 Stage
BAYLPSS400B	LP Kit with Stainless Steel Burners	3	✓	(except 026)	(except 026)
BAYLPSS410A	LP Kit with Stainless Steel Burners	3	—	S8X1A026	S8B1A026
BAYHANG	Horizontal hanging kit	2	✓	✓	✓
BAYSF1165A	1" SlimFit Box with MERV 4 Filter (side return)	5	✓	✓	✓
BAYFLTR203	Horizontal Filter Kit for B Cabinets	5	✓	✓	✓
BAYFLTR204	Horizontal Filter Kit for C Cabinets	5	✓	✓	✓
BAYFLTR205	Horizontal Filter Kit for D Cabinets	5	✓	✓	✓
BAYVENT600A①	Internal venting kit	11	✓	✓	✓
BAYVENT800B	Masonry Chimney Vent Kit	11	✓	✓	✓
PIP02095	U fitting for gas piping	1	✓	✓	✓
BAYLIFTB	Dual return kit. B cabinet size extension	8	✓	✓	✓
BAYLIFTC	Dual return kit. C cabinet size extension	9	✓	✓	✓
BAYLIFTD	Dual return kit. D cabinet size extension	9	✓	✓	✓
BAYBASE205	Downflow subbase	8	✓	✓	✓
BAYFLTR206	Filter Access Door Kit (Downflow only)	2	✓	✓	✓
BAYSF1165	16x20 1" side return filter rack	✓	✓	✓	✓
BAYSF1255	16x25 1" side return filter rack (bottom return for 17.5" cabinets)	✓	✓	✓	✓
BAYBURNERSS	Stainless steel natural gas burner kit	✓	✓	✓	✓

① Compatible with B, C, and D width cabinets.

Platinum 80, Gold 80v, Gold 80, Silver 80h, Silver 80, and American Standard 80 Gas Furnaces Airflow Directions

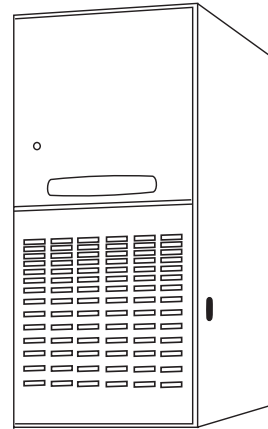
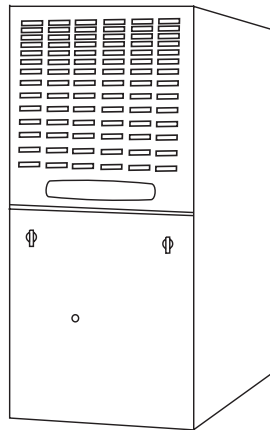

UPFLOW, DOWNFLOW, HORIZONTAL LEFT OR RIGHT

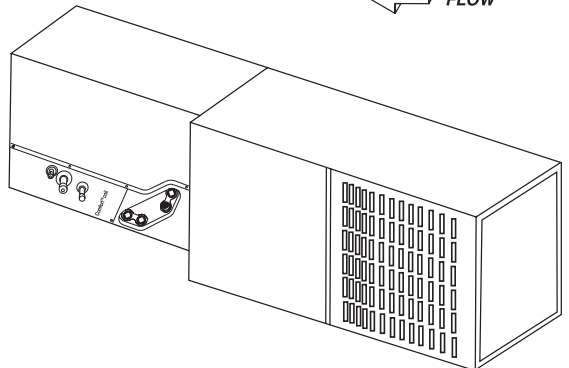
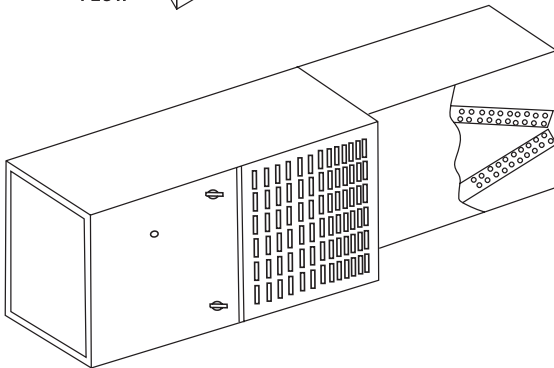
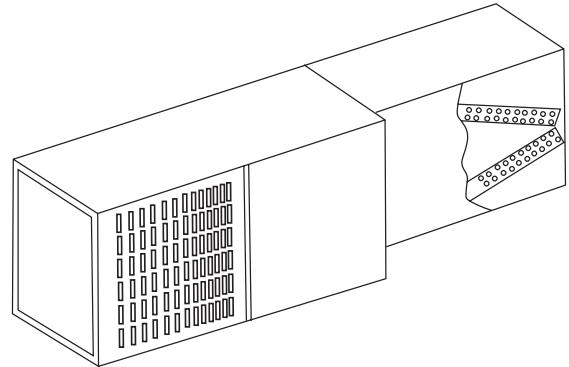
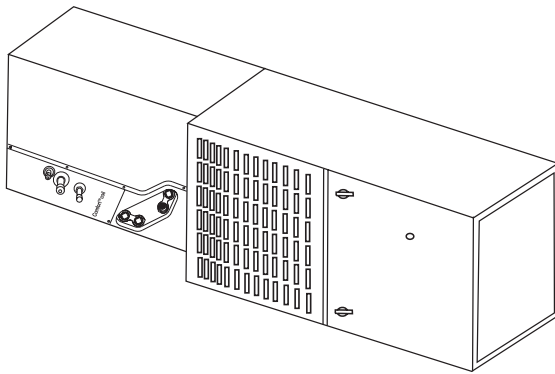

Note: The non-condensing, forty inch (40") height furnaces may be laid on either side for horizontal application. Connection brackets for coil/furnace alignment are included with the furnaces. The apex of the coil may point into or away from the airflow.

Platinum 80 – Communicating Two Stage ECM Variable Speed

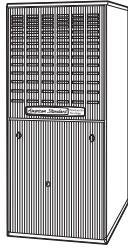

Platinum 80 Upflow

Table FUR-15-A — Platinum 80 Upflow/Horizontal Left or Right Induced Draft Gas Furnace (115/1/60) ①②④

Unit Model No.	Airflow		Output (Btuh)		ICS ^③ AFUE	Flue Size (in)	Ignition Device	Uncrated Dimensions (in.) H x W x D	Shipping Weight (lbs.)	Max Fuse*	Filter Sizes**
	In Tons	Stage 2	Stage 1	Stage 1							
AUD2B060ACV32B	3	48,000	31,200	48,000	80.0	4	Silicon Nitride	40 x 17 ¹ / ₂ x 28	136	15	17 x 25 x 1
AUD2B080ACV32B	3	64,000	41,600	64,000	80.0	4	Silicon Nitride	40 x 17 ¹ / ₂ x 28	142	15	17 x 25 x 1
AUD2C080ACV42B	4	64,000	41,600	64,000	80.0	4	Silicon Nitride	40 x 21 x 28	155	15	17 x 25 x 1
AUD2B100ACV32B	3	80,000	52,000	80,000	80.0	4	Silicon Nitride	40 x 17 ¹ / ₂ x 28	148	15	17 x 25 x 1
AUD2C100ACV52B	5	79,000	52,000	79,000	80.0	4	Silicon Nitride	40 x 21 x 28	175	15	20 x 25 x 1
AUD2D120ACV52B	5	97,000	62,400	97,000	80.0	4	Silicon Nitride	40 x 24 ¹ / ₂ x 28	193	15	24 x 25 x 1
AUD2D140ACV52B	5	111,000	72,800	111,000	80.0	4	Silicon Nitride	40 x 24 ¹ / ₂ x 28	197	15	24 x 25 x 1



Platinum 80 Downflow

Table FUR-15-B — Platinum 80 Downflow/Horizontal Left or Right Induced Draft Gas Furnace (115/1/60) ①②④

Unit Model No.	Airflow		Output (Btuh)		ICS ^③ AFUE	Flue Size (in)	Ignition Device	Uncrated Dimensions (in.) H x W x D	Shipping Weight (lbs.)	Max Fuse*	Filter Sizes
	In Tons	Stage 2	Stage 1	Stage 1							
ADD2B060ACV32B	3	48,000	31,200	48,000	80.0	4	Silicon Nitride	40 x 17 ¹ / ₂ x 28	140	15	(2) 14 x 20 x 1
ADD2B080ACV32B	3	63,000	41,600	63,000	80.0	4	Silicon Nitride	40 x 17 ¹ / ₂ x 28	146	15	(2) 14 x 20 x 1
ADD2C100ACV52B	5	81,000	52,000	81,000	80.0	4	Silicon Nitride	40 x 21 x 28	166	15	(2) 16 x 20 x 1
ADD2D120ACV52B	5	95,000	62,400	95,000	80.0	4	Silicon Nitride	40 x 24 ¹ / ₂ x 28	197	15	(2) 16 x 20 x 1

Note: Variable speed furnaces should not be twinned and are not approved for twinning applications.

① Must use communicating thermostat with AccuLink™ II control.

② Field convertible to 24V non-communicating.

③ Isolated Combustion System.

④ Direct drive variable speed motor is an ECM constant airflow blower motor.

* Information subject to change. Please confirm with current Product Data/Service Facts for current factory production.

** For Upflow furnaces, the size is for a bottom return filter.

Gold 80v – Two Stage ECM Variable Speed

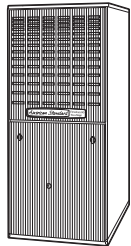

Gold 80v Upflow

Table FUR-15-C — Gold 80v Upflow/Horizontal Left or Right Induced Draft Gas Furnace (115/1/60) ②

Unit Model No.	Airflow		Output (Btuh)		ICS ^③ AFUE	Flue Size (in)	Ignition Device	Uncrated Dimensions (in.) H x W x D	Shipping Weight (lbs.)	Max Fuse*	Filter Sizes**
	In Tons	Stage 2	Stage 1	Stage 1							
AUD2B060A9V3VB	3	48,000	31,200	48,000	80.0	4	Silicon Nitride	40 x 17 ¹ / ₂ x 28	136	15	17 x 25 x 1
AUD2B080A9V3VB	3	64,000	41,600	64,000	80.0	4	Silicon Nitride	40 x 17 ¹ / ₂ x 28	142	15	17 x 25 x 1
AUD2C080A9V4VB	4	64,000	41,600	64,000	80.0	4	Silicon Nitride	40 x 21 x 28	166	15	17 x 25 x 1
AUD2C080B9V4VB①	4	64,000	41,600	64,000	80.0	4	Silicon Nitride	40 x 21 x 28	166	15	17 x 25 x 1
AUD2B100A9V3VB	3	80,000	52,000	80,000	80.0	4	Silicon Nitride	40 x 17 ¹ / ₂ x 28	142	15	17 x 25 x 1
AUD2C100A9V5VB	5	79,000	52,000	79,000	80.0	4	Silicon Nitride	40 x 21 x 28	166	20	20 x 25 x 1
AUD2C100B9V5VB①	5	79,000	52,000	79,000	80.0	4	Silicon Nitride	40 x 21 x 28	166	20	20 x 25 x 1
AUD2D120A9V5VB	5	97,000	62,400	97,000	80.0	4	Silicon Nitride	40 x 24 ¹ / ₂ x 28	193	20	24 x 25 x 1
AUD2D120B9V5VB①	5	97,000	62,400	97,000	80.0	4	Silicon Nitride	40 x 24 ¹ / ₂ x 28	193	20	24 x 25 x 1
AUD2D140A9V5VB	5	111,000	72,800	111,000	80.0	4	Silicon Nitride	40 x 24 ¹ / ₂ x 28	197	20	24 x 25 x 1

Table FUR-15-D — Gold 80v Downflow/Horizontal Left or Right Induced Draft Gas Furnace (115/1/60) ②

Unit Model No.	Airflow		Output (Btuh)		ICS ^③ AFUE	Flue Size (in)	Ignition Device	Uncrated Dimensions (in.) H x W x D	Shipping Weight (lbs.)	Max Fuse*	Filter Sizes
	In Tons	Stage 2	Stage 1	Stage 1							
ADD2B060A9V3VA	3	48,000	31,200	48,000	80.0	4	Silicon Nitride	40 x 17 ¹ / ₂ x 28	140	15	(2) 14 x 20 x 1
ADD2B080A9V3VA	3	63,000	41,600	63,000	80.0	4	Silicon Nitride	40 x 17 ¹ / ₂ x 28	146	15	(2) 14 x 20 x 1
ADD2C100A9V5VA	5	81,000	52,000	81,000	80.0	4	Silicon Nitride	40 x 21 x 28	166	20	(2) 16 x 20 x 1
ADD2D120A9V5VA	5	95,000	62,400	95,000	80.0	4	Silicon Nitride	40 x 24 ¹ / ₂ x 28	197	20	(2) 16 x 20 x 1

Note: Variable speed furnaces should not be twinned and are not approved for twinning applications.

① Model has high efficiency blower assembly.

② This furnace family uses a two speed draft inducer.

③ Isolated Combustion System.

* Information subject to change. Please confirm with current Product Data/Service Facts for current factory production.

** For Upflow furnaces, the size is for a bottom return filter.



Gold 80v Downflow

Platinum 80, Gold 80v, Convertible Gas Furnaces

Furnaces

Table FUR-16-A — Features

	AUD2/ACV ADD2/ACV 2 Stage 1 or 2 Pipe ①	AUD2-9V ADD-9V 2-Stg. ①
• Service diagnostics with faults reported at the user interface	✓	—
• AccuLink™ system	✓	—
• Can be connected in communicating or 24V non-communicating modes.....	✓	—
• User interface for system configuration - Easy to use navigation buttons and plain text for clear description of features	✓	—
• 3-way vent option on downflow models (top,right or left) (downflow models only)	—	✓
• 24 volt secondary fuse	—	✓
• Direct drive, variable speed ECM blower motor*	✓	✓
• Comfort-R™ enhanced mode (cooling).....	✓	✓
• Meets requirements for 2% or less air leakage.....	✓	✓
• Adjustable heating fan off timing	✓	✓
• Alternate bottom/left/right return air (upflow models only)	✓	✓
• Attractive color accents	✓	✓
• Blower door safety switch.....	✓	✓
• Bottom Panel (upflow models only)	✓	✓
• Cleanable/reusable high velocity filters.....	✓	✓
• Common vent capability.....	✓	✓
• Complete front service access.....	✓	✓
• Gasketed blower door	✓	✓
• Heavy gauge reinforced wrap-around steel cabinet	✓	✓
• Horizontal left/right without conversion required	✓	✓
• Humidifier/EAC hook-up capability	✓	✓
• Inner blower door panel (downflow models only).....	✓	✓
• Insulated blower compartment 4 sides (upflow models only)	✓	✓
• Integrated solid state control w/self diagnostics.....	✓	✓
• Left/right gas connection.....	✓	✓
• Manual reset flame roll out switches	✓	✓
• Masonry Chimney Venting w/BAYVENT800B (upflow models)	✓	✓
• Multi-port in shot burners	✓	✓
• Perfect fit door latches (upflow models only)	✓	✓
• Right or left hand side knock out for venting (downflow models only)	②	✓
• Selectable cooling fan off delay eliminates need for time delay relay	✓	✓
• Service diagnostic capabilities	✓	✓
• Side return starter tabs (upflow models only).....	✓	✓
• Silicon Nitride hot surface igniter with adaptive heat up	✓	✓
• Single door filter access	✓	✓
• Slide out blower assembly.....	✓	✓
• 20 gauge aluminized steel heat exchanger	✓	✓
• Two heating blower speeds.....	✓	✓
• Two speed venter motor.....	✓	✓
• Two tone color.....	✓	✓
• Two-stage gas valve.....	✓	✓
• Limited lifetime heat exchanger warranty & 10-year on all other functional parts (Residential Use)	✓	✓
• Optional extended warranties available	✓	✓

Note: Variable speed furnaces should not be twinned and are not approved for twinning applications.

① Variable Speed

② Selectable through thermostat

*Constant airflow ECM (electronically commutated motor).

**Constant airflow ECM (electronically commutated motor).

Platinum 80, Gold 80v, Gold 80, Silver 80h, Silver 80, and American Standard 80 Convertible Gas Furnaces

Table FUR-17-A — Optional Accessories			AUD2-ACV/ADD2-ACV 2 Stage Variable Speed	AUD2-9V/ ADD2-9V 2-Stg. Variable Speed
Model Number	Description	Shipping Weight		
BAYBASE205	Downflow subbase for downflow models only	8	✓	✓
BAYFLTR200	Side Filter Rack (External)	5	✓	✓
BAYFLTR203	Filter kit horiz conversion for 17.5" cabinet	3	✓	✓
BAYFLTR204	Filter kit horiz conversion for 21" cabinet	3	✓	✓
BAYFLTR205	Filter kit horiz conversion or 24.5" cabinet	3	✓	✓
BAYFLTR206	Filter Access Door Kit (Downflow only)	2	✓	✓
BAYFLTR321 ^①	Cleanable filter for 21" cabinet upflow only	2	✓	✓
BAYFLTR324 ^①	Cleanable filter for 24.5" cabinet upflow only	2	✓	✓
BAYLPKT210B	Propane conversion kit	1	✓	✓
BAYLPSS210B	LP Kit with Stainless Steel Burners	1	✓	✓
BAYRACK960A ^②	Filter Rack Kit for upflow models only (internal)	5	✓	✓
BAYVENT800B	Masonry chimney vent kit	2	✓	✓

^① Contains one (1) high velocity filter.

^② Internal filter rack for side or bottom return air. Includes 17 x 25" cleanable filter for use in side return applications. Bottom return applications require different sizes of filters which are not included. Airflow requirements over 1800 CFM require filters on both sides or a side and bottom or bottom only.

Table FUR-17-B — Optional Accessories			AUD2/ADD2 2 Stage	AUD1-H/ADD1-H 1 Stage High Efficiency	AUD1/ADD1 1 Stage	AUE1/ADE1 1 Stage
Model Number	Description	Shipping Weight				
BAYBASE205	Downflow subbase for downflow models only	8	✓	✓	✓	✓
BAYFLTR200	Side Filter Rack (External)	5	✓	✓	✓	—
BAYFLTR203	Filter kit horiz conversion for 17.5" cabinet	3	✓	✓	✓	✓
BAYFLTR204	Filter kit horiz conversion for 21" cabinet	3	✓	✓	✓	✓
BAYFLTR205	Filter kit horiz conversion or 24.5" cabinet	3	✓	✓	✓	✓
BAYFLTR206	Filter Access Door Kit (Downflow only)	2	✓	✓	✓	✓
BAYFLTR317 ^①	Cleanable filter for 14.5" and 17.5" cabinet upflow only	2	✓	✓	✓	✓
BAYFLTR321 ^①	Cleanable filter for 21" cabinet upflow only	2	✓	✓	✓	✓
BAYFLTR324 ^①	Cleanable filter for 24.5" cabinet upflow only	2	✓	✓	✓	✓
BAYLPKT210B	Propane conversion kit	1	✓	✓	✓	✓
BAYLPSS210B	LP Kit with Stainless Steel Burners	1	✓	✓	✓	✓
BAYRACK960A ^②	Filter Rack Kit for upflow models only (internal)	5	✓	✓	✓	✓
BAYVENT800B	Masonry chimney vent kit	2	✓	✓	✓	✓

Note: Variable speed furnaces should not be twinned and are not approved for twinning applications.

^① Contains one (1) high velocity filter.

^② Internal filter rack for side or bottom return air. Includes 17 x 25" cleanable filter for use in side return applications. Bottom return applications require different sizes of filters which are not included. Airflow requirements over 1800 CFM require filters on both sides or a side and bottom or bottom only.

BUILT TO A HIGHER STANDARD[®]

American Standard[®]

HEATING & AIR CONDITIONING

High Efficiency Oil Furnaces

Ordering Information

Variable and Non-Variable Speed High Efficiency Oil Furnaces

American Standard Oil Furnaces are available from your local distributor.

For availability and support, contact your local distributor.

Furnaces



Intertek

BUILT TO A HIGHER STANDARD

American Standard
HEATING & AIR CONDITIONING

L8X1 - Single Stage, Ultra-Low NOx Gas Furnace



L8X1A055
L8X1B070
L8X1C100

Table FUR-19-A — L8X1 - Single Stage, Ultra-Low NOx Gas Furnace

Model Number	Airflow in Tons	Output (BTUH)	ICS AFUE	Flue Size (in.)	Ignition Device	Uncrated Dimensions (in.)			Shipping Weight (lbs.)	Max. Fuse	Filter Sizes
						H	W	D			
L8X1A055U3XSAAA	3 ^①	44,000	80.0	4	Silicon Nitride	34 ¹ / ₂	14 ¹ / ₅	28	107	15	14 x 25 x 1
L8X1B070U4XSAAA	4	56,000	80.0	4	Silicon Nitride	34 ¹ / ₂	17 ¹ / ₂	28	135	15	16 x 25 x 1
L8X1C100U5XSAAA	5	80,000	80.0	4	Silicon Nitride	34 ¹ / ₂	21	28	144	20	20 x 25 x 1



L8X1B060
L8X1B080

Table FUR-19-B — L8X1 - Single Stage, Ultra-Low NOx Gas Furnace

Model Number	Airflow in Tons	Nominal Output (BTUH)	ICS AFUE	Flue Size (in.)	Ignition Device	Uncrated Dimensions (in.)			Shipping Weight (lbs.)	Max. Fuse	Filter Sizes
						H	W	D			
L8X1B060U3XSAAA	3	48,000	80.0	4	Silicon Nitride	34	17 ¹ / ₂	28 ³ / ₄	118	15	16 x 25 x 1
L8X1B080U4XSAAA	4	64,000	80.0	4	Silicon Nitride	34	17 ¹ / ₂	28 ³ / ₄	125	15	16 x 25 x 1

Table FUR-19-C — Features

	A55, B70, C100	B60, B80
• Cabinet height (in.).....	34.5	34.0
• 3-Way poise (Upflow, Horizontal Left, Horizontal Right).....	✓	—
• Cabinet has no knockouts.....	—	✓
• Single stage.....	✓	✓
• 5 speed, Constant Torque ECM blower motor.....	✓	✓
• Stainless Steel, Tubular heat exchanger.....	—	✓
• Aluminized Steel, Tubular heat exchanger.....	✓	—
• Insulated blower compartment.....	✓	✓
• Painted cabinet with two tone color.....	—	✓
• Vortica™ II Blower Housing.....	—	✓
• Meets requirements for 1% or less cabinet air leakage ②.....	—	✓
• Silicon Nitride hot surface igniter.....	✓	✓
• 20-year limited warranty on the heat exchanger & 10-year on all other functional parts.....	✓	✓

① Special consideration should be taken in duct design, evaporator coil selection/pressure drop, and air filter selection to achieve 350 CFM/ton at 0.5" external static pressure.

② A55, B70, and C100 models certified to 2% cabinet air leakage

Table FUR-19-D — Optional Accessories

Model Number	Description	A55, B70, C100	B60, B80
BAYSPACER.....	6 inch vertical coil spacer.....	✓	—

Furnaces

Envirowise™ CleanEffects™ Whole House Air Cleaner



Envirowise™ CleanEffects™ Whole House Air Cleaner:

- Envirowise™ CleanEffects™ removes up to 99.98% @ .3 Micron size allergens from the filtered air
- Removes a lesser % of particles down to .01 micron in size
- Outperforms HEPA type filters, and up to 100 times more effective than a standard 1" filter
- Constructed of painted 18 gage metal to protect the filter and internal electronics
- Power door provides easy access to internal components and features a filter status display as well as safety interlocks that automatically shut down the power when the door is opened for maintenance or cleaning
- Designed for flush fit on both sides and rear of equipment cabinet
- No transitions required with Envirowise™ CleanEffects™ when used on Trane cabinets
- Gaskets included with the air cleaner
- ComfortLink II™ communicating or 24 volt capability
- **10-Year Limited Warranty**
No registration required
- Envirowise™ CleanEffects™ certified as **asthma & allergy friendly™** by AAFA

Table IAQ-1-A – Air Handler – 24 Volt Envirowise™ CleanEffects™ Whole House Air Cleaner

Model Number	Airflow Range	Trane CleanEffects™ Air Handler Width	Uncrated Dimensions(in.) H x W x D	Shipping Weight
EFD175DLAH000AA	300-1200	17½ inch	7½ x 17½ x 21	37
EFD215DLAH000AA	300-1200	21½ inch	7½ x 21½ x 21	42
EFD235DLAH000AA	350-1600	23½ inch	7½ x 23½ x 21	44
EFD260DLAH000AA	400-2000	26 inch	7½ x 26 x 21	46

Table IAQ-1-B – Upflow / Side Return Furnace – 24 Volt Envirowise™ CleanEffects™ Whole House

Model Number	Airflow Range	Trane CleanEffects™ Furnace Width	Uncrated Dimensions(in.) H x W x D	Shipping Weight
EFD145DLFR000AA	300-1200	14½ inch ^①	7½ x 14½ x 27	39
EFD175DLFR000AA	300-1600	17½ inch ^①	7½ x 17½ x 27	43
EFD210DLFR000AA	300-2000	21 inch ^②	7½ x 21 x 27	47
EFD245DLFR000AA	400-2000	24½ inch ^②	7½ x 24½ x 27	49

Table IAQ-1-C – Downflow Furnace – 24 Volt Envirowise™ CleanEffects™ Whole House

Model Number	Airflow Range	Trane CleanEffects™ Furnace Width	Uncrated Dimensions(in.) H x W x D	Shipping Weight
EFD17DDLFR000AA	300-1600	17½ inch	7½ x 17½ x 21	37
EFD21DDLFR000AA	300-2000	21 inch	7½ x 21 x 21	41

Table IAQ-1-D — Accessories – Envirowise™ CleanEffects™ Whole House

Model Number	Description	Used With	Shipping Weight
BAYTRANS12024	120 to 24 Volt Transformer	All TFD Air Cleaners	6

① Side return no transition required.

② Side return transition required.

Perfect Fit™ Filter Accessories

Table IAQ-2-A — Furnace Cartridge Media

Model Number	Description	Qty	Enclosure Used with	Shipping Weight
BAYFTFREXM2	Expandable 5" Cartridge Media Filter	2 / Box	14 1/2 - 24 1/2 x 21	5

Table IAQ-2-B — Air Handler Cartridge Media

Model Number	Description	Qty	Enclosure Used with	Shipping Weight
BAYFTAHEXM2	Expandable 5" Cartridge Media Filter	2 / Box	21 1/2-26 x 27	5

Table IAQ-2-C — Furnace Frames - Subject to existing inventory

Model Number	Description	Qty	Enclosure Used with	Shipping Weight
BAYFRAME145①	Expandable Media Filter	1 / Box	14 1/2	5
BAYFRAME175①	Expandable Media Filter	1 / Box	17 1/2	5
BAYFRAME210①	Expandable Media Filter	1 / Box	21	5
BAYFRAME245①	Expandable Media Filter	1 / Box	24 1/2	5

Table IAQ-2-D — Air Handler Frames - Subject to existing inventory

Model Number	Description	Qty	Enclosure Used with	Shipping Weight
BAYFRAME215①	Expandable Media Frame	1 / Box	21	5
BAYFRAME235①	Expandable Media Frame	1 / Box	23 1/2	5
BAYFRAME260①	Expandable Media Frame	1 / Box	26	5

① Includes one filter.



SlimFit Filters

- Available in all cabinet widths for the TEM Air Handlers.
- Available for the S-Series Furnaces with side return.
- Polyslate Gray 18 gauge steel painted frame to match cabinet
- Low profile 2" depth cabinet
- Hinged front door for easy filter replacement
- Service First MERV 4 rated pleated filter included for recurring revenue on SlimFit sizes. Will also accommodate off the shelf retail filters.
- Easy Installation and competitively priced
- Fully insulated R-4.2 door
- Insulated cabinet to prevent sweating

Table IAQ-2-E - SlimFit Filters

Part Number	Part Description	Dimensions (in.)
BAYSF1165BAA	1" Filter and Frame (Side Return Furnace)	16 ⁵ / ₈ x 20 ³ / ₈ x 2
BAYSF1185BAA	1" Filter and Frame, 18 1/2	18 1/2 x 21 x 2
BAYSF1235BAA	1" Filter and Frame, 23 1/2	23 1/2 x 21 x 2
BAYSF11255BAA	1" Filter and Frame (Side Return Furnace)	16 ⁵ / ₈ x 25 1/2 x 2
BAYSF1265BAA	1" Filter and Frame, 26 1/2	26 1/2 x 21 x 2
FLRSF1165*	1" Media Filter (Side Return Furnace)	16 1/4 x 20 1/4 x 3/4
FLRSF1185*	1" Media Filter	17 3/4 x 19 3/4 x 3/4
FLRSF1235*	1" Media Filter	22 3/4 x 19 3/4 x 3/4
FLRSF1255*	1" Media Filter (Side Return Furnace)	16 1/4 x 25 1/4 x 3/4
FLRSF1265*	1" Media Filter	25 3/4 x 19 3/4 x 3/4

*Shipped in cartons of 12

BUILT TO A HIGHER STANDARD

American Standard
HEATING & AIR CONDITIONING

QuikBox™ Media Cabinet and Filters



- New Cost Improved Replacement for TFM Perfect Fit Media Filter
- 9 Perfect Fit Sizes to match Air Handler or Furnace Cabinet dimensions
- 5" Depth 18 Gauge Metal Painted Cabinet w/ Fully insulated R-4.2 Door
- New MERV 11 Collapsible "Shirt-Box" type filter included
- Air Tite Door Construction with Gasketing and Quarter Turn Easy Open Latch
- Cabinet Gasketing included for improved leakage at equipment connection
- QuikBox Replacement Filters are Backward Compatible to Fit Every TFM FilterBox

Table IAQ-3-A– QuikBox™ Cabinet with Filter

Old Perfect Fit Model	New QuikBox Model	Nominal Cabinet Size H x W x D	Airflow Range Cfm	Shipping Weight
TFM175B0FR0	EQBFM175A0FR11	5" x 17.5" x 27"	300-1500	20
TFM17DA0FR0	EQBFM17DA0FR11	5" x 17.5" x 21"	300-1600	20
TFM210B0FR0	EQBFM210A0FR11	5" x 21.0" x 27"	300-2000	22
TFM215B0AH0	EQBFM215A0AH11	5" x 21.5" x 21"	300-1400	20
TFM235B0AH0	EQBFM235A0AH11	5" x 23.5" x 21"	300-1700	22
TFM245B0FR0	EQBFM245A0FR11	5" x 24.5" x 27"	400-2000	24
TFM260B0AH0	EQBFM260A0AH11	5" x 26.0" x 21"	400-2000	24
N/A	EQBFM165A0FR11	5" x 20.5" x 16.75"	400-1600	20
N/A	EQBFM185A0AH11	5" x 18.5" x 21"	400-1600	22

Table IAQ-3-B– QuikBox™ Replacement Filters

Perfect Fit Furnace	Old Filter Part Number	Dimensions(in.) H x W x D	New Filter Part Number	Efficiency Rating
TFM145B0FR0	BAYFTFR14M2	13.7 x 26 x 4.7	FLRQB5FR14M11	MERV 11
TFM175B0FR0	BAYFTFR17M2	16.7 x 26 x 4.7	FLRQB5FR17M11	MERV 11
TFM210B0FR0	BAYFTFR21M2	20.2 x 26 x 4.7	FLRQB5FR21M11	MERV 11
TFM245B0FR0	BAYFTFR24M2	23.7 x 26 x 4.7	FLRQB5FR24M11	MERV 11
New	N/A	15.75 x 19 x 4.7	FLRQB5FR16M11	MERV 11
TFM17DA0FR0	BAYFTDN17M2	16.7 x 20 x 4.7	FLRQB5DN17M11	MERV 11

Table IAQ-3-C– QuikBox™ Replacement Filters

Perfect Fit Air Handler	Old Filter Part Number	Dimensions(in.) H x W x D	New Filter Part Number	Efficiency Rating
TFM215B0AH0	BAYFTAH21M2	20.7 x 20 x 4.7*	FLRQB5AH21M11	MERV 11
TFM235B0AH0	BAYFTAH23M2	22.7 x 20 x 4.7	FLRQB5AH23M11	MERV 11
TFM260B0AH0	BAYFTAH26M2	25.2 x 20 x 4.7	FLRQB5AH26M11	MERV 11
New	N/A	17.75 x 20 x 4.7	FLRQB5AH18M11	MERV 11

* Note:

Fits phased out TFM21DAFR0 Perfect Fit Cabinet

Indoor Air Quality

BUILT TO A HIGHER STANDARD[®]

American Standard[®]
HEATING & AIR CONDITIONING

Envirowise™ CleanEffects™ Dimensions

Table IAQ-4-A — Air Handler Filters

ifD Filter	AIR HANDLER MODEL NUMBER	
	A	B
AFD215	21½	19
AFD235	23½	21
AFD260	26	23½

OUTLINE DRAWING AIR HANDLER MODELS

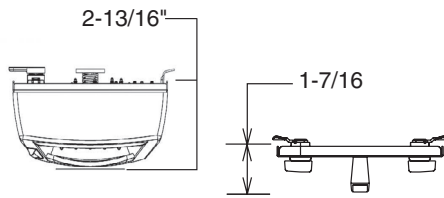

21" CABINET DEPTH ONLY
ADD DOOR DEPTH FOR TOTAL

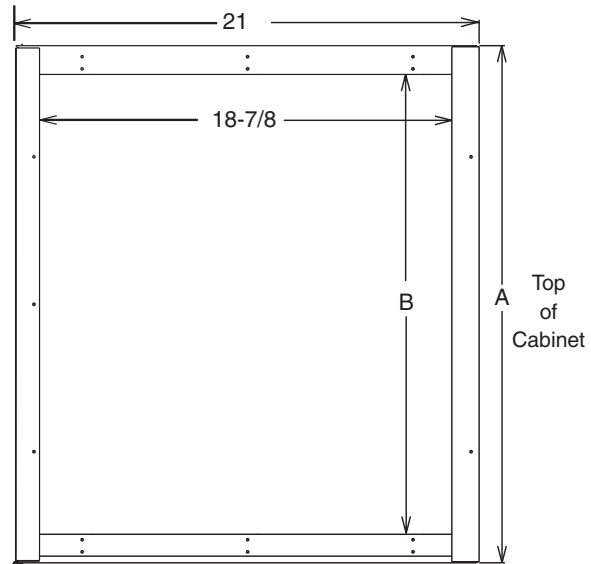
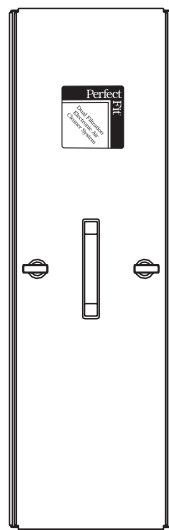
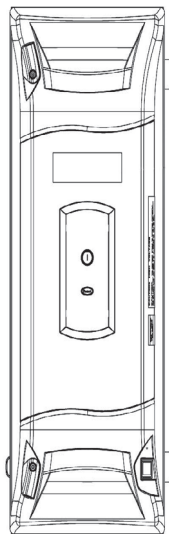
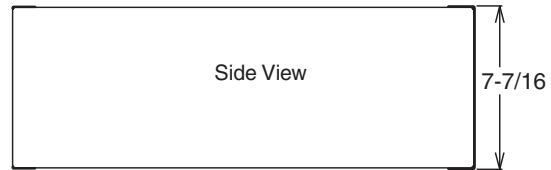

Envirowise™
CleanEffects™

5" MEDIA

Indoor Air Quality

For complete equipment / combination selections, installation instructions and warranty information, please refer to Product Data/Ratings and/or Installers Guides and Limited Warranty Handbooks.

Envirowise™ CleanEffects™ Dimensions

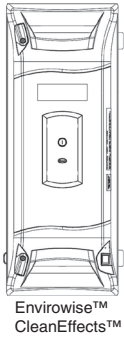
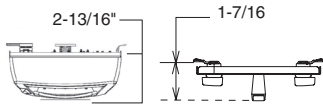

Table IAQ-5-A — Upflow Furnace Filters

FURNACE MODEL NUMBER		
ifD Filter	A	B
AFD145	14½	12
AFD175	17½	15
AFD210	21	18½
AFD245	24½	22

Table IAQ-5-B — Downflow Furnace Filters

FURNACE MODEL NUMBER		
ifD Filter	A	B
AFD14D	14½	11⅞
AFD17D	17½	14⅞
AFD21D	21	18⅞
AFD24D	24½	21⅞

**OUTLINE DRAWING
 DOWNFLOW FURNACE MODELS**

21" CABINET DEPTH ONLY
 ADD DOOR DEPTH FOR TOTAL

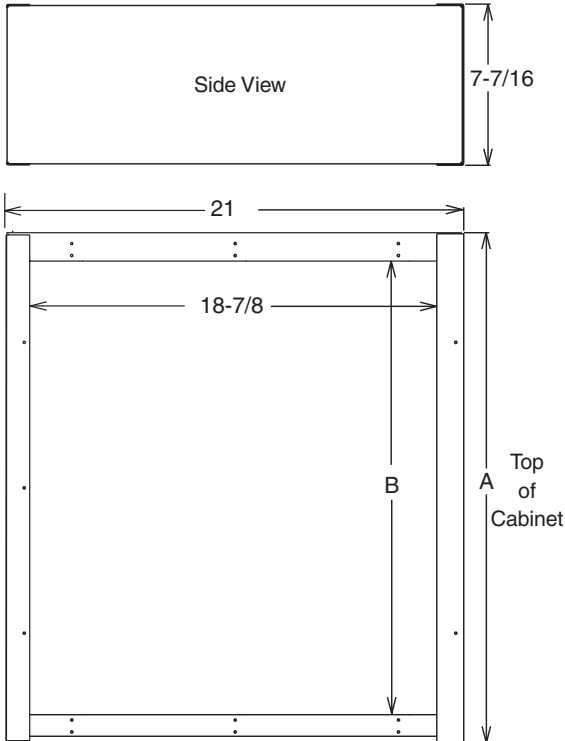

OUTLINE DRAWING UPFLOW FURNACE MODELS

27" CABINET DEPTH ONLY
 ADD DOOR DEPTH FOR TOTAL

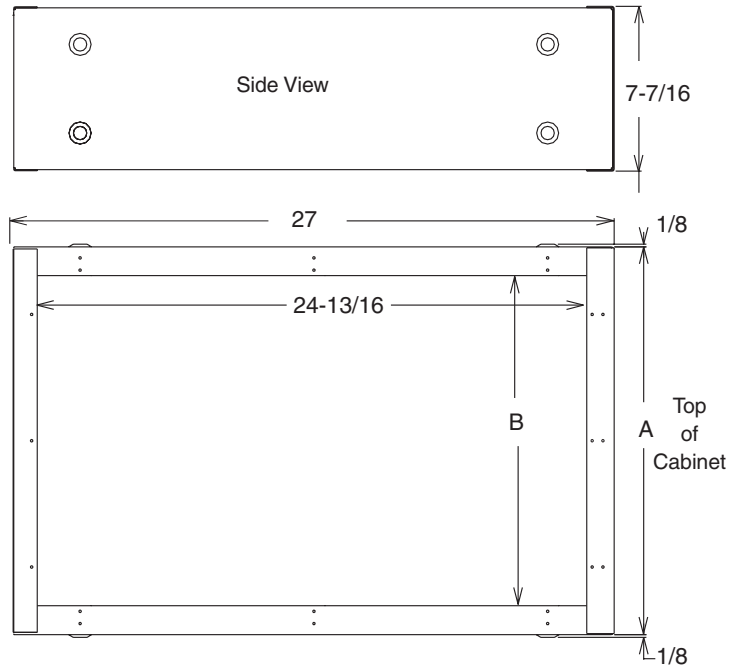

Indoor Air Quality

Humidifiers Steam



EHUMD800ASM00BA
EHUMD800BSMLCBA

EHUMD800A

- Electrode Type Steam Canister means fast, easy, low cost maintenance.*
- Six Different Capacities In One Unit to satisfy any application from 11.5 gallons per day to 34.6 gallons per day.
- Automatic Shut Down after 72 hours of inactivity; unit will drain to eliminate standing water.
- Easy Mounting Flexibility to your existing duct work or can be remotely mounted.
- Choose Precise Relative Humidity % Settings based on your needs and outdoor conditions. Works with Nexia™-enabled controls without the need for additional controls.
- Humidity “On Demand” uses your HVAC system blower to distribute humidified air throughout your home without a call for heating from your furnace or heat pump.
- Five-Year Standard Warranty includes all functional Parts. Limited Warranty available.
- All Inclusive Package means there is nothing else to purchase. Includes manual humidistat and blower relay. Nexia-enabled control is optional.

*Replace once a year

EHUMD800LC

- Envirowise™ model 800LC Steam Humidifier is recommended for all 120V installations.
- Two Different Capacities at 11.5 gallons per day and 16 gallons per day.
- Comes with model 8043 LCRP Canister
- Faster start-up and 35% more electrode surface area than model 800 with 120v application

Table IAQ-6-A — Steam Humidifier Models

Part Number	Part Description	Dimensions - W"xD"xH"	Weight (lbs)
EHUMD800ASM00B	Steam Humidifier w/ Manual Control	10.125 x 7.125 x 20.875	23
EHUMD800BSMLCBA	Steam Humidifier Low Conductivity w/ Manual Control	10.125 x 7.125 x 20.875	23

Table IAQ-6-B — Specifications: Humidifier with Humidistat

Conductivity	Grains/Gal	Hardness	Recommended Model installed at 208/240v
75-100	0-3	Naturally Soft	Model 800LC
100-300	3-9	Naturally Soft	Model 800LC
300-500	9-15	Slightly Hard	Model 800
500-650	15-20	Moderately Hard	Model 800
650-850	20-25	Hard	Model 800
850-1250	25-36	Very Hard	Model 800
above 1250	above 36	Extremely Hard	Installation Not Recommended

Table IAQ-6-C — Accessories

Model Number	Description
8043RP	Canister, Rplc, 6-Pk, Serv First
8043LCRP	Replacement Steam Canister-Low Conductivity Model
5625RP	Humidistat, Manual, Serv First
5628RP	Drain Trap Assy, Serv First
5629RP	Air Flow Switch, Serv First
5630RP	High Humidity Switch, Serv First
5632RP	Condensate Pump Kit, Serv First
56TR	Convertible Automatic Humidifier Control, Trane Brand

1. What model is recommended for 120VAC installations?
a. The Model 800LC and 80LC canister are recommended regardless of water conditions.

Humidifiers Fan Powered and Bypass



EHUMD500A

EHUMD500A

- Flow Through Fan Powered Humidifier
- High Performance Humidifier Delivers up to 18 Gallons per Day
- Automatic Humidifier Control with O.D. Sensor for up to 50% more Humidity
- Front Cover Access for easy replacement of humidifier pad
- Aluminum Humidifier Pad Treated with Ceramic Coating for Enhanced Pad Performance
- Reliable Brass Solenoid Valve w/Stainless Steel Valve Seat
- UV Resistant Cabinet and Scale Control Insert
- Saddle Valve
- Polyslate Gray Housing matches Furnace Cabinet Color
- EnviroWise nameplate
- 120V Power Line Cord
- 110V Primary/24A Transformer



EHUMD200A, 300A

EHUMD200, 300A

- EHUMD300A Bypass delivers up to 17 Gallons per day
- EHUMD200A delivers up to 12 Gallons per day
- EHUMD300A Automatic Humidifier Control and O.D. Sensor for up to 50% more Humidity
- EHUMD200A Manual Humidifier Control
- UV Resistant Cabinet and Scale Control Insert
- Front Cover Access for easy replacement of humidifier pad
- Aluminum Humidifier Pad Treated with Ceramic Coating for Enhanced Pad Performance
- Reliable Brass Solenoid Valve w/Stainless Steel Valve Seat
- Field Convertible Duct Connection, Left or Right Side
- Built in Summer / Winter Damper
- Saddle Valve
- Polyslate Gray Housing matches Furnace Cabinet Color
- EnviroWise nameplate
- 110V Primary/24V Secondary, 10VA Transformer

Table IAQ-7-A — Specifications: Humidifier with Humidistat

Model Number	Description	Used With	Shipping Weight
EHUMD500APA00C ^{①④}	Fan Powered Humidifier	All Furnace Models	20
EHUMD300ABA00B ^②	Large Bypass Humidifier	All Furnace Models	15
EHUMD200ABM00B ^③	Small Bypass Humidifier	All Furnace Models	14

- ① Includes Automatic Humidifier Control (Duct Mount Only).
 ② Includes Automatic Humidifier Control (Duct Mount Only) and 120/24V transformer.
 ③ Includes Manual Humidifier Control and 120/24V transformer.
 ④ Not applicable for horizontal installations.

Table IAQ-7-B — Accessories

Model Number	Description	Used With
BAYPAD02A1310A	Large Humidifier Pad 13"x10"	EHUMD500,300A
BAYPAD01A1010A	Small Humidifier Pad 9-7/8"x9-5/8"	EHUMD200A
ECONTH01AAUTOA	Automatic Humidifier Control	EHUMD200A
BAYRLY10ASENSA	Current Sensing Relay	All
BAYPLT01AMHCOA	Adapter Plate (Duct Mount)	Manual Humidifier Control]
5804 American Standard Badge	American Standard Badge Bag (10 ea.)	EHUMD200, EHUMD300
5806 American Standard Badge	American Standard Badge Bag (10 ea.)	EHUMD500

Humidifiers

Fan Powered and Bypass

EHUMD500APA00C FAN POWERED HUMIDIFIER

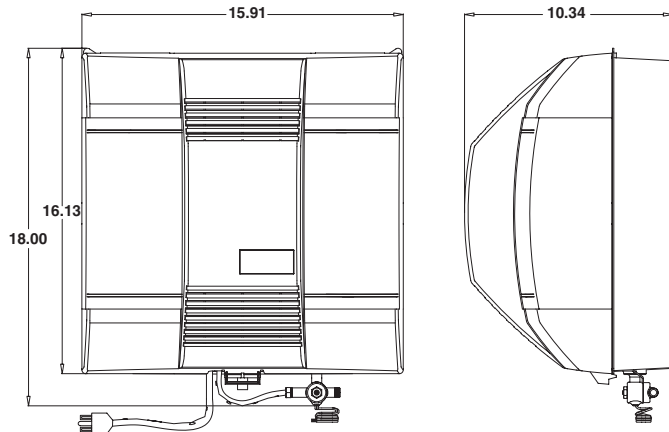

EHUMD300ABA00B LARGE BYPASS HUMIDIFIER

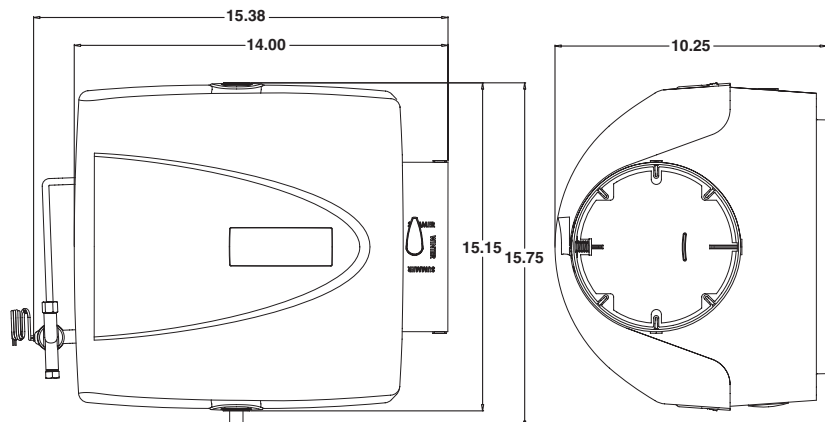

EHUMD200ABM00B SMALL BYPASS HUMIDIFIER

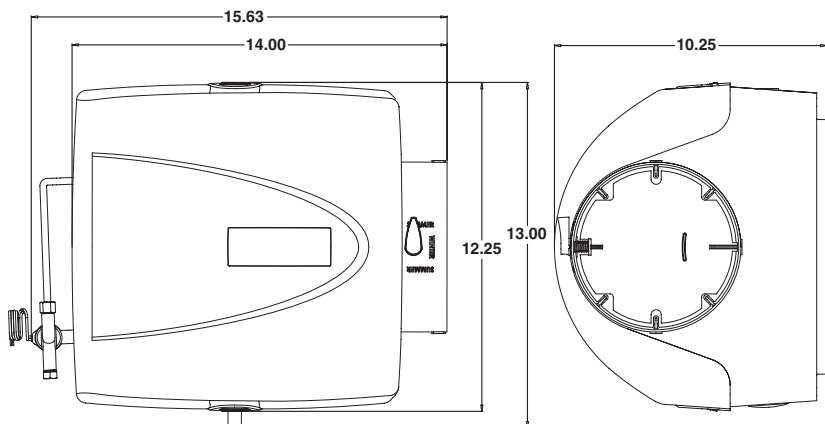

Indoor Air Quality

Humidifiers Fan Powered and Bypass

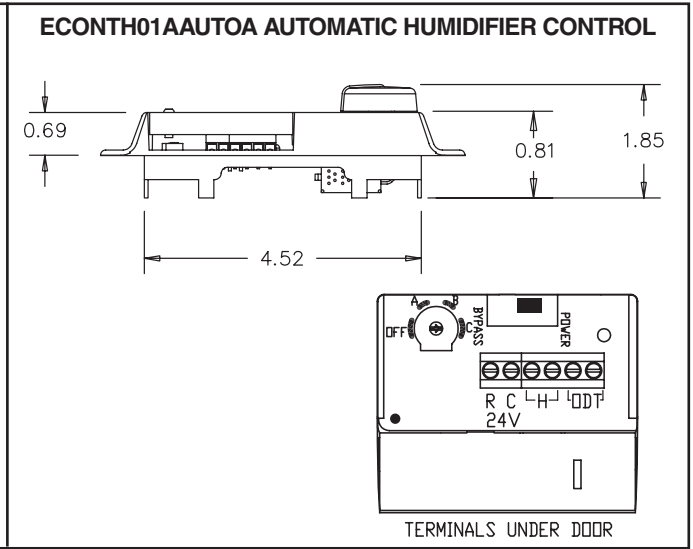
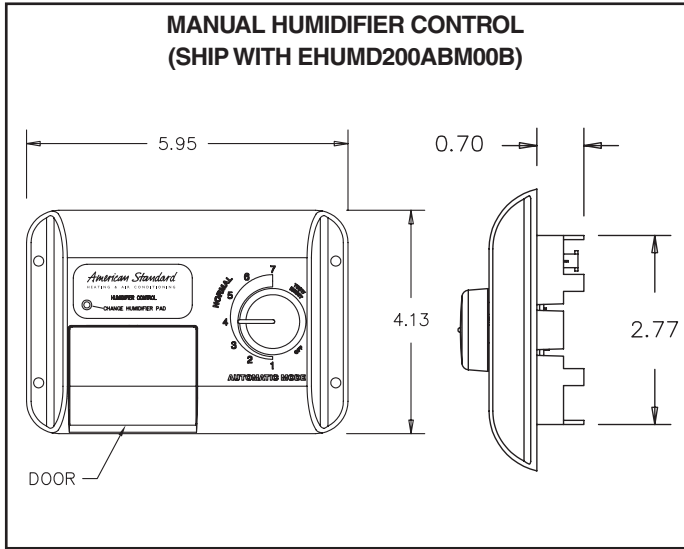

SUGGESTED BYPASS HUMIDIFIER LOCATIONS

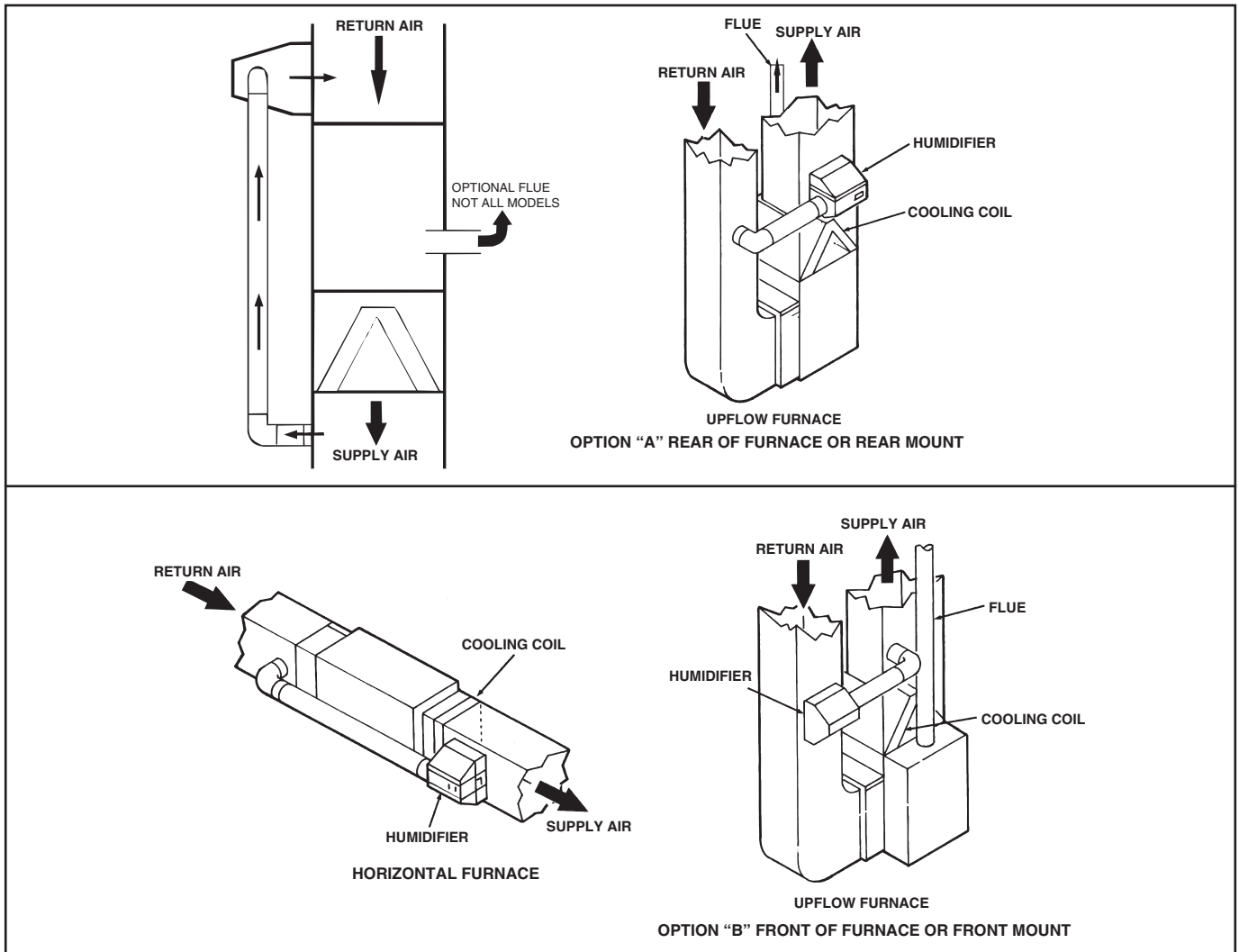

For complete equipment / combination selections, installation instructions and warranty information, please refer to Product Data/Ratings and/or Installers Guides and Limited Warranty Handbooks.

Indoor Air Quality

BUILT TO A HIGHER STANDARD™

American Standard
HEATING & AIR CONDITIONING

Envirowise™ QF130V Inline Ventilator



EVENQF130V1NAAA

EVENQF130V

- Full ECM motor, adjustable airflow from 30 to 130 cfm
- Programmable to prevent temperature and humidity extremes
- Includes MERV 8 filter for improved indoor air quality
- Quiet fan (.4 – 1.6 Sones) is virtually undetectable when operating
- “On - Off” switch on unit or controlled by 24V remote wired smart thermostat with ventilation software
- Compact design fits between framing members and comes with hanger brackets

Table IAQ-10-A — Specifications: Envirowise™ QF130V Inline Ventilator

Part Number	Part Description	Dimensions - W"xD"xH"	Weight (lbs)
EVENQF130V1NAAA	Inline Ventilator Fan with Relay	15.75 x 12.75 x 23	18

Table IAQ-10-B — Accessories

Model Number	Description	Dimensions - W"xD"xH"	Weight (lbs)
E1650024	Heater Model EQH400	14.5 x 14 x 10.25	8.25
E1650025	Heater Model EQH900	14.5 x 14 x 10.25	8.25
E1650026	6" Motorized Damper	6.3 x 9.45 x 10.63	4.5
E1955001	6" Screened Wall Cap	9 x 9 x 17	3
E1650123	2 Pack 10x10x2 Filter	10 x 10 x 4	0.95



EDHUM70V1H1MDA

Envirowise™ QF70V Inline Dehumidifying Ventilator

EDHUM70V

- 62.2 Compliant Ventilation with Dehumidification Control
- Controlled mechanical Ventilation for humid climates, especially Climate Zones 1, 2, and 3
- Automatically turns on compressor when entering air is above enthalpy set-point based on climate setting using on-board sensor
- Ventilation up to 125 cfm – sufficient for a 4BR, 3000 sq.' home
- May be ducted with 100% ventilation air, mixed with indoor air, or used as a ducted or stand-alone dehumidifier
- Standard with MERV 11 pleated filter for improved indoor air quality
- Optional dedicated D30 control or use one of our Nexia (trademark) enabled Thermostats to control ventilation or dehumidification
- Up to 70 pints/per day for dehumidification or up to 30 grains of moisture/lb. of outside air for ventilation

Table IAQ-10-C — Specifications: Envirowise™ QF70V Inline Ventilator

Part Number	Part Description	Dimensions - W"xD"xH"	Weight (lbs)
EDHUM70V1H1MDA	Ventilating 70 Pint Dehumidifier	12 x 12 x 28 with Collars	55
		12 x 12 x 22 without Collars	54

Table IAQ-10-D — Accessories

Model Number	Description	Dimensions - W"xD"xH"	Efficiency Rating
E4037861	6" Motorized Damper		
E4037863	8" Gravity Damper (70)		
E4037869	Hang Kit, Small (70 & 98)		
E4037874	Filter Case (qty 4)	9"X11"X1"	MERV 11 (70)
E4037887	MERV 14 Filter Housing		
E4037891	Filter Case (qty 3)	20" X 24" X 4"	MERV 14
E4037901	Condensate Pump Kit (70)		
E4037907	6" Inlet Hood		
E4037881	Filter Case (qty 12)	9"X11"X1"	MERV 11 (70)
E4037893	D30 Control		
E4037897	D30R Control w/ Remote		

For complete equipment / combination selections, installation instructions and warranty information, please refer to Product Data/Ratings and/or Installers Guides and Limited Warranty Handbooks.

Envirowise™ Whole Home Dehumidifiers with Optional Ventilation



EDHUM098V1H1MDAA



EDHUM1551H1MDAA

- Full Line of Horizontal Dehumidifiers from 98 ppd. To 205 ppd. of moisture removal
- Exclusive XT coil technology means higher efficiency humidity removal rates than standard units
- All Units are Energy Star rated
- All units come with optional ventilation capability to meet ASHRAE 62.2 Ventilation requirements
- Units can be ducted to and wired to operate with HVAC system or can used independently of HVAC system with internal blower and wired control
- Units come standard with MERV 11 filter for improved indoor air quality
- 5 Year Unit Replacement Warranty for Refrigeration Circuit Failures (Registered Warranty)



Table IAQ-11-A — Specifications: Envirowise™ Whole Home Dehumidifiers with Optional Ventilation

Model Number	Description	Dimensions- W" x H" x L"	Weight (lbs.)
EDHUM70V1H1MDAA	Ventilating Dehumidifier, 50-70 pint category, 1800 sq' ft. capacity	12 x 12 x 28	55
EDHUM0981H1MDAA	Ventilating Dehumidifier, 90-100 pint category, 2300 sq' ft. capacity	14.5 x 19.5 x 32.375	81
EDHUM1051H1MDAA	XT Highest Efficiency Ventilating Dehumidifier, 100-110 pint category, 2500 sq' ft. capacity	20.25 x 21.75 x 41.50	140
EDHUM1551H1MDAA	XT Highest Efficiency Ventilating Dehumidifier, 140-160 pint category, 3500 sq' ft. capacity	20.25 x 21.75 x 41.50	140
EDHUM2051H1MDAA	XT Highest Efficiency Ventilating Dehumidifier, 175-210 pint category, 5000 sq' ft. capacity	20.25 x 21.75 x 41.50	140

Table IAQ-11-B — Accessories

Model Number	Description	Dimensions- W" x H" x L"	Weight (lbs.)
E4037861	6" Motorized Damper	11 6 6	3
E4037863	8" Gravity Damper (70)	12 12 10	2
E4037865	10" Gravity Damper (98,105)	12 12 10	3
E4037867	10" Oval to Round Adapter (105)	14 14 14	3
E4037869	Hang Kit, Small (70,98)	22 6 6	4
E4037872	Hang Kit, Large (105)	24 6 6	5
E4037874	Filter Case (qty 4), 9"X11"X1", MERV 11 (70)	12 12 6	2
E4037876	Filter Case (qty 4), 14"X17.5"X1.75", MERV 11 (98)	18 16 8	2
E4037878	Filter Case (qty 4), 16"X20"X2", MERV 11 (120,105)	20 20 12	2
E4037881	Filter Case (qty 12), 9"X11"X1", MERV 11 (70)	14 14 14	5
E4037883	Filter Case (qty 12), 14"X17.5"X1.75", MERV 11 (98)	18 18 24	5
E4037885	Filter Case (qty 12), 16"X20"X2", MERV 11 (120,105)	25 25 25	8
E4037887	MERV 14 Filter Housing	24 20 8	12
E4037891	Filter Case (qty 3), 20" X 24" X 4", MERV 14 (Filter Housing)	26 20 14	2
E4037893	D30 Control	9 6 2	1
E4037897	D30 Control w/ Remote	8 6 4	1
E4037901	Condensate Pump Kit (70)	14 10 6	5
E4037903	Condensate Pump Kit (98)	14 12 6	5
E4037905	Condensate Pump Kit (105)	14 10 6	5
E4037907	6" Inlet Hood		

Indoor Air Quality

BUILT TO A HIGHER STANDARD[®]

American Standard[®]
HEATING & AIR CONDITIONING

Energy Recovery Ventilator (ERV)



EERVR

- **American Standard** ERV technology for all seasons and climates
- Static plate energy transfer core for efficient transfer of heat and moisture
- Passive defrost - condensate drain not required
- Balancing dampers not required
- Multi position mounting
- Percent Timer (PT) control included with ERV for simple, automatic operation
- Optional Push Button (PB) control connects to PT control
- Pull-down door latches for quick service access
- Heavy gauge, powder painted steel cabinet
- Permanently lubricated motor bearings (ball bearings)
- 6" and 8" double collar duct connections for EERVR100 and 200
- 8" round compatible duct connection for EERVR300
- Closed cell foam gasketing for insulation integrity
- 1" duct board insulation with cleanable foil face
- May be installed in conditioned and unconditioned spaces
- Cabinet / Door color: American Standard Polyslate Gray
- **5 year Parts Warranty. No registration required**
- **Registered Limited Warranty 10-years**
- **MERV 8 replaceable filter included**

Table IAQ-12-A — Specifications: ERV

Model Number	Nominal Airflow (CFM)	Power Supply	Uncrated Dimensions (In.) H x W x D	Shipping Weight
EERVR100A1P00B ^①	130	120/1/60	20 ¹ / ₈ x 28 ³ / ₄ x 13	65
EERVR200A1P00B ^①	200	120/1/60	20 ¹ / ₈ x 28 ³ / ₄ x 23 ⁷ / ₈	85
EERVR300A1P00B ^①	300	120/1/60	20 ¹ / ₈ x 28 ³ / ₄ x 23 ⁷ / ₈	95

^① Percent Timer Control included with the ERV.

Table IAQ-12-B — Specifications: ERV

Model Number	Sensible Recovery Effectiveness(32°F)	Latent Recovery (32°F)	Total Recovery (95°F)
EERVR100A1P00B	72% @ 124 cfm	55% @ 124 cfm	46% @ 126 cfm
EERVR200A1P00B	78% @ 181 cfm	62% @ 181 cfm	52% @ 180 cfm
EERVR300A1P00B	70% @ 295 cfm	51% @ 295 cfm	43% @ 295 cfm

Table IAQ-12-C — Optional Accessories

Model Number	Description	Used With	Shipping Weight
ECONV10APBC0A	Point of Use Push Button Control	ERV models 100, 200, 300	1
FLR08618	Filters - 2 per pack	ERV models 100	1
FLR08619	Filters - 2 per pack	ERV models 200, 300	1
BAYWHT10AVENTA ^②	6 inch White Vinyl Ventilation Hood	ERV models 100, 200	1
BAYBRN10AVENTA ^②	6 inch Brown Vinyl Ventilation Hood	ERV models 100, 200	1
BAYGLV10AVENTA ^②	8 inch Galvanized Ventilation Hood	ERV models 300	2

^② Qty 1.

Indoor Air Quality

For complete equipment / combination selections, installation instructions and warranty information, please refer to Product Data/Ratings and/or Installers Guides and Limited Warranty Handbooks.

Conventional 24 Volt Connected Controls

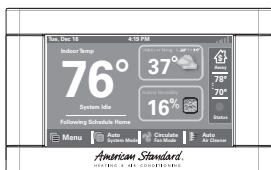

**GOLD 824
ACONT824AS52DB**

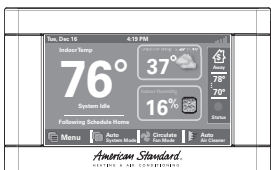

**GOLD 824
ACONT824AS52DA**



ACONT824AS52DB

- Energy Star certified
- Nexia™ Z-Wave Plus Bridge Inside
- Nexia™ Diagnostics ①
- Connect over 200 Z-Wave devices①②
- WiFi or Ethernet connection
- Control from a smartphone, tablet, or computer ①②
- 4.3" Color touchscreen
- 7 Day programmable with up to four schedules per day
- Five day weather forecast, weather radar, and weather alerts ①
- Indoor relative humidity display
- Enhanced dehumidification (cooling)
- 2 Auxiliary dry contacts control 2 of the following: Whole house humidifier, dehumidifier, or ventilation system
- Test modes and alert diagnostics
- Screen access restrictions
- Over-the-air software upgrade ①
- Local software upgrade option
- Color: Designer Silver
- Retail Package Sleeve
- Limited Warranty: 5 yr. base/10 yr. registered

ACONT824AS52DA

- Nexia™ Z-Wave Bridge Inside
- Connect over 200 Z-Wave devices①②
- WiFi or Ethernet connection
- Control from a smartphone, tablet, or computer ①②
- 4.3" Color touchscreen
- 7 Day programmable with up to four schedules per day
- Five day weather forecast, weather radar, and weather alerts ①
- Indoor relative humidity display
- Enhanced dehumidification (cooling)
- 2 Auxiliary dry contacts control 2 of the following: Whole house humidifier, dehumidifier, or ventilation system
- Test modes and alert diagnostics
- Screen access restrictions
- Nexia™ Diagnostics ①
- Over-the-air software upgrade ①
- Local software upgrade option
- Silver color
- Limited Warranty: 5 yr. base/10 yr. registered

Application:

- Conventional gas/electric, heat pump, and dual fuel systems
- Conventional boiler systems (forced air only)
- Conventional HVAC systems:
- 2 Heat / 2 cool
- Heat Pump systems: Up to 5 stages heat / 2 stages cool (2 compressor heat - 3 auxiliary heat / 2 cooling)
- Heat Pump switchover valve: selectable "with cool or with heat"
- Remote wired indoor temperature sensor (optional) ZZSENSAL0400AA
- Remote wireless indoor temperature and humidity sensor (optional): ZSENS930AW00MA
- Remote wired outdoor temperature sensor (optional) BAYSEN01ATEMPA
- PWM Circuit (BK terminal): controls indoor unit variable speed blower
- Wall cover plate BAYCOVR800A

Dimensions:

- Product: 5.43"w x 3.39"h x 1.30"d
- Display: 4.15"w x 2.65"h

Application:

- Conventional gas/electric, heat pump, and dual fuel systems
- Conventional boiler systems (forced air only)
- Conventional HVAC systems:
- 2 Heat / 2 cool
- Heat Pump systems: Up to 5 stages heat / 2 stages cool (2 compressor heat - 3 auxiliary heat / 2 cooling)
- Heat Pump switchover valve: selectable "with cool or with heat"
- Remote wired indoor temperature sensor (optional) ZZSENSAL0400AA
- Remote wireless indoor temperature and humidity sensor (optional): ZSENS930AW00MA
- Remote wired outdoor temperature sensor (optional) BAYSEN01ATEMPA
- PWM Circuit (BK terminal): controls indoor unit variable speed blower
- Wall cover plate BAYCOVR800A

Dimensions:

- Product: 5.43"w x 3.39"h x 1.30"d
- Display: 4.15"w x 2.65"h

① Requires internet service and Nexia™ smart home system registration.

② Nexia™ remote climate access is included with the purchase for up to 8 Connected Controls per home. Adding accessories or additional controls to your Nexia™ system may require a monthly subscription.

BUILT TO A HIGHER STANDARD[®]

American Standard[®]

HEATING & AIR CONDITIONING

Conventional 24 Volt Connected Controls

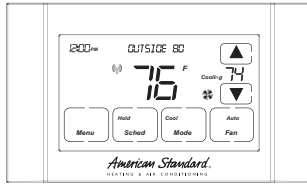

**SILVER 724
ACONT724AS42DA**



ACONT724AS42DA

- WiFi connectivity to Nexia™ Smart Home ①②
- Nexia™ Diagnostics ①
- Control from a smartphone, tablet, or computer ①②
- 4.3" diagonal black and white touchscreen
- 7 Day programmable with up to 4 schedules per day
- Humidity sensor and RH display
- Remote temperature sensor connections (1 indoor/1 outdoor)
- Auxiliary & compressor heat lockouts
- Auxiliary dry contact
- Enhanced dehumidification (cooling)
- PWM Circuit (BK terminal): controls indoor unit variable speed blower
- Energy Savings Mode (ESM)
- Screen lock and guest lock
- Service test modes
- Upgradable software
- Color: Designer Silver
- Retail Package Sleeve
- Limited Warranty: 1 yr. base/5 yr. registered

Application:

- Up to 4 Stages Heat/2 Stages Cool
- Conventional gas/electric, heat pump, and dual fuel systems
- Conventional boiler systems (baseboard & radiators)
- Remote wired indoor temperature sensor (optional): ZZSENSAL0400AA
- Remote wired outdoor temperature sensor (optional): BAYSEN01ATEMPA
- Wall cover plate BAYCOVR800A
- Nexia™ Bridge is required for control of Z-Wave devices, such as lighting, door locks, etc., and remote climate access. The Nexia™ Bridge is purchased separately. ①②

Dimensions:

- Product: 5.9"w x 3.47"h x .95"d
- Display: 3.8"w x 2.3"h

For complete equipment / combination selections, installation instructions and warranty information, please refer to Product Data/Ratings and/or Installers Guides and Limited Warranty Handbooks.

① Requires internet service and Nexia™ smart home system registration.
② Nexia™ remote climate access is included with the purchase for up to 8 Connected Controls per home. Adding accessories or additional controls to your Nexia™ system may require a monthly subscription. Remote access is via most web-enabled smartphones, tablets and computers.
③ Requires Nexia™ Bridge

BUILT TO A HIGHER STANDARD*

American Standard[®]
HEATING & AIR CONDITIONING

AccuLink™ Communicating Connected Controls

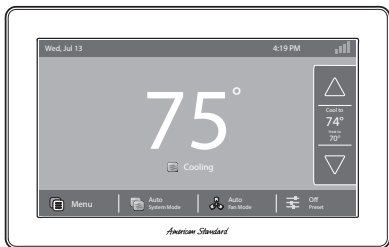

**PLATINUM 1050
AZON1050AC52ZA**



AZON1050AC52ZA

- Nexia™ Z-Wave Plus Bridge Inside
- Connect over 200 Z-Wave devices^{①②}
- Nexia™ Diagnostics ^①
- WiFi or Ethernet connection
- Control from a smartphone, tablet, or computer ^{①②}
- 7" diagonal color touchscreen
- 1-Touch Presets - Home, Away, Sleep
- 7 Day programmable with up to four schedules per day
- Customizable Home Screen
- Runtime History
- Allergy and Quick Clean Air Cycles
- Smart Continuous Fan
- Adjustable Continuous Airflow (35-100%)
- Screen access restrictions
- Dealer Contact Widget
- Service, Filter, Humidifier, UV Light, Air Cleaner Reminders
- Five day weather forecast, weather radar, and weather alerts ^①
- Indoor relative humidity display
- Test modes and alert diagnostics
- Over-the-air Software Upgrade ^①
- Local Software Upgrade option
- Color: Designer Silver
- Retail Package Sleeve
- Limited Warranty: 5 yr. base/10 yr. registered

Application:

- AccuComfort™ Variable Speed
- AccuLink™ II Two Stage Systems
- AccuLink™ II Zoning Systems
- AccuComfort™ Variable speed outdoor cooling or heat pump unit combined with S-Series non-communicating variable speed furnace and "C" model Relay Panel
- Relay panel (BAY24VRP52DC) is required when applied with conventional systems (Gas Electric, Heat Pump, Dual Fuel, Boilers - forced air only)
- Relay Panel Supports:
 - Up to 5 stages heat, 2 stages cool
 - Connections for Remote indoor and outdoor temperature sensors
 - 3 Dry Auxiliary Contacts to control whole house humidifier, dehumidifier, or ventilation system
- Remote wired indoor temperature sensor (optional) ZZSENSAL0400AA
- Remote wireless indoor temperature and humidity sensor (optional): ZSENS930AW00MA
- Remote wired outdoor temperature sensor (optional) BAYSEN01ATEMPA

Dimensions:

- Product: 7.2"w x 4.5"h x 1.2"d
- Display: 6.1"w x 3.3"h

For complete equipment / combination selections, installation instructions and warranty information, please refer to Product Data/Ratings and/or Installers Guides and Limited Warranty Handbooks.

CCZS-3

^① Requires internet service and Nexia™ smart home system registration.
^② Nexia™ remote climate access is included with the purchase for up to 8 Connected Controls per home. Adding accessories or additional controls to your Nexia™ system may require a monthly subscription. Remote access is via most web-enabled smartphones, tablets and computers.

Effective 1/1/20
14-1011-37

BUILT TO A HIGHER STANDARD[®]

American Standard[®]

HEATING & AIR CONDITIONING

AccuLink™ Communicating Connected Controls

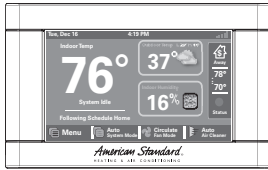

**PLATINUM 850
ACONT850AC52UB**



ACONT850AC52UB

- Nexia™ Z-Wave Plus Bridge
- Connect over 200 Z-Wave devices^{①②}
- WiFi or Ethernet connection
- Control from a smartphone, tablet, or computer ^{①②}
- 4.3" diagonal color touchscreen
- Compatible with AccuLink™ communicating systems (variable speed and two stage)
- Compatible with conventional 24 volt HVAC, heating, heat pump, and dual fuel systems when used with accessory relay panel model BAY24VRPAC52DC
- 7 Day programmable with up to four schedules per day
- Five day weather forecast, radar, and alerts ^①
- Indoor relative humidity display
- Test modes and alert diagnostics
- Nexia™ Diagnostics ^①
- Over-the-air software upgrades ^①
- Local software upgrade option
- Color: Designer Silver
- Wall cover plate BAYCOVR800A
- Retail Package Sleeve
- Limited Warranty: 5 yr. base/10 yr. registered

Application:

- AccuLink™ II communicating systems (variable speed and two stage)
- Variable speed outdoor cooling combined with S-Series non-communicating variable speed furnace and "C" model Relay Panel
- Conventional gas/electric, heat pump, dual fuel systems, or boiler systems (forced air only) with use of relay panel model BAY24VRPAC52DB. Relay panel controls up to 5 stages heat, 2 stages cool, remote indoor and outdoor connections, humidifier, dehumidifier, and ventilation system.
- Remote wired indoor temperature sensor (optional) ZZSENSAL0400AA
- Remote wireless indoor temperature and humidity sensor (optional): ZSENS930AW00MA
- Remote wired outdoor temperature sensor (optional) BAYSEN01ATEMPA

Dimensions:

- Product: 5.43"w x 3.39"h x 1.30"d
- Display: 4.15"w x 2.65"h

Wall Cover Plate

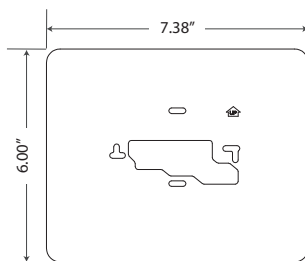

BAYCOVR800A

BAYCOVR800A

Application:

- Use with
ACONT624AS42DA,
ACONT724AS42DA,
ACONT824AS52DA,
ACONT850AC52UA

Dimensions:

- 7.38" w x 6.00" h
- Finish: Silver

- ^① Requires internet service and connection to Nexia™ smart home system.
- ^② Nexia™ remote climate access is included with the purchase of up to 8 Connected Controls per home. Adding accessories to your Nexia™ system may require a monthly subscription for remote access via most web-enabled smartphones, tablets and computers.

BUILT TO A HIGHER STANDARD[®]

American Standard[®]
HEATING & AIR CONDITIONING

AccuLink™ Communicating Connected Controls

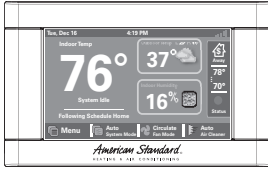

**PLATINUM 850
ACONT850AC52UA**



ACONT850AC52UA

- Nexia™ Z-Wave Bridge
- Connect over 200 Z-Wave devices^{①②}
- WiFi or Ethernet connection
- Control from a smartphone, tablet, or computer^{①②}
- 4.3" diagonal color touchscreen
- Compatible with AccuLink™ communicating systems (variable speed and two stage)
- Compatible with conventional 24 volt HVAC, heating, heat pump, and dual fuel systems when used with accessory relay panel model BAY24VRPAC52DC
- 7 Day programmable with up to four schedules per day
- Five day weather forecast, weather radar, and weather alerts^①
- Indoor relative humidity display
- Test modes and alert diagnostics
- Nexia™ Diagnostics^①
- Over-the-air software upgrades^①
- Local software upgrade option
- Silver color
- Wall cover plate BAYCOVR800A
- Limited Warranty: 5 yr. base/10 yr. registered

Application:

- AccuLink™ II communicating systems (variable speed and two stage)
- Variable speed outdoor cooling combined with S-Series non-communicating variable speed furnace and "C" model Relay Panel
- Conventional gas/electric, heat pump, dual fuel systems, or boiler systems (forced air only) with use of relay panel model BAY24VRPAC52DB. Relay panel controls up to 5 stages heat, 2 stages cool, remote indoor and outdoor connections, humidifier, dehumidifier, and ventilation system.
- Remote wired indoor temperature sensor (optional) ZZSENSAL0400AA
- Remote wireless indoor temperature and humidity sensor (optional): ZSENS930AW00MA
- Remote wired outdoor temperature sensor (optional) BAYSEN01ATEMPA

Dimensions:

- Product: 5.43"w x 3.39"h x 1.30"d
- Display: 4.15"w x 2.65"h

BUILT TO A HIGHER STANDARD[®]

American Standard[®]

HEATING & AIR CONDITIONING

Zoning Communicating Sensor with Display

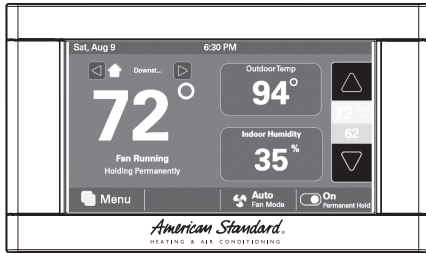

AZON1040AC52ZA

AZON1040AC52ZA

- For use with AccuLink™II Zoning Systems
- 3-Wire Communicating Zone Sensor
- 4.3" diagonal color touchscreen
- Zone Mode - Auto only
- Fan Mode - Auto/On
- Displays Zone Temperature & Relative Humidity.
- Average multiple zone temp sensors
- Displays Outdoor Temperature (Nexia registration or wired ODT required)
- Clean Screen Function
- 3 Levels of Restricted Access
- Fahrenheit or Celcius
- Adjust zone Setpoint at 1040, 1050, and Nexia Smart Home
- Schedule 1040, 1050, and Nexia Smart Home
- Zone Schedule Override
 - Permanent Hold
- Enter zone name at 1040 and 1050
- Local software upgrades
- Screen color with backlit options
- Screensaver options

Dimensions:

- Product: 5.43"w x 3.39"h x 1.30"d
- Display: 4.15"w x 2.65"h

Storage Temperature:

- -40°F to 170°F, 0% - 95% RH

Operating Temperature:

- 32°F - 120°F, 5% - 90% RH non-condensing

Conventional 24 Volt HVAC System Interface Relay Panel for AccuLink™ Controls

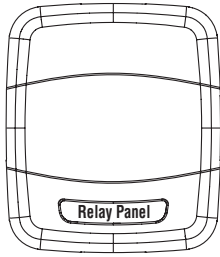

BAY24VRPAC52DC

BAY24VRPAC52DC — With AUX Contact Control

- 5 Heat (Gas, Oil, Electric)/2 Cool/Heat Pump/Dual Fuel
- Optional remote indoor temperature connection point
- Optional remote outdoor temperature connection point
- LED stage indicators
- Removable low voltage terminal blocks for easy service and replacement
- **AUX Contacts**
 - Whole-house Dehumidifier Control
 - Ventilation Control
 - Humidifier Control
- Relay Panel provides support for the following equipment combination:
 - Variable speed heat pump and cooling units
 - S-Series Non-communicating Variable Speed Furnace
 - ACONT850AC52UA or AZON1050AC52ZA

Dimensions:

- 8.0" width x 9.3" height x 1.9" depth

Storage Temperature:

- -40° to 175°F, 5% - 95% RH non-condensing

Operating Temperature:

- -40° to 150°F, 5% - 95% RH non-condensing

AccuLink™ Platinum 1050 Control Component Overview

Communicating System

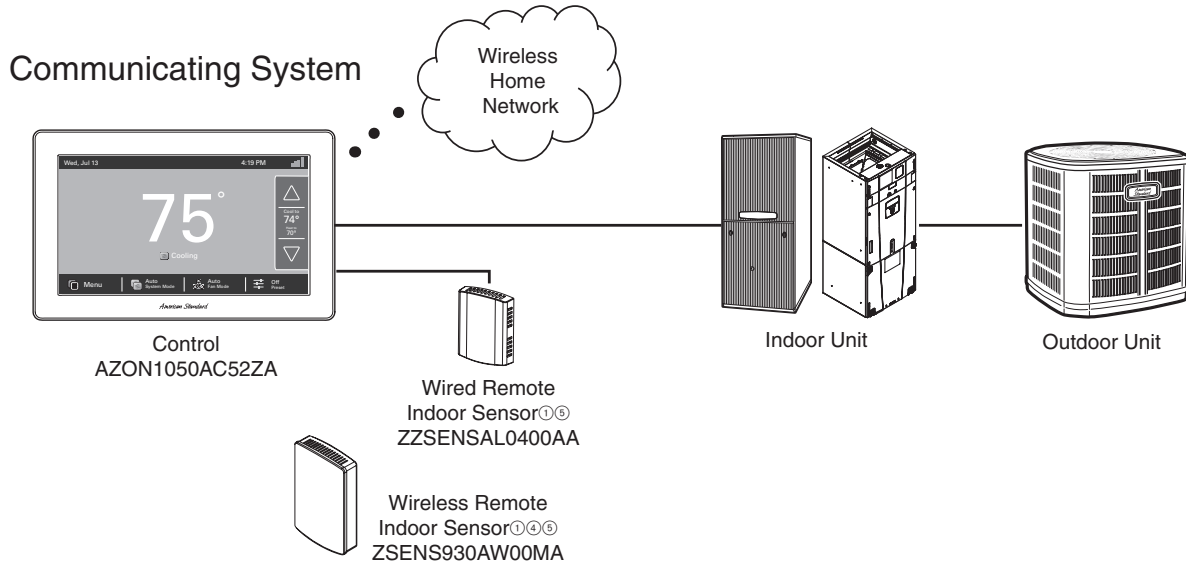

24V System

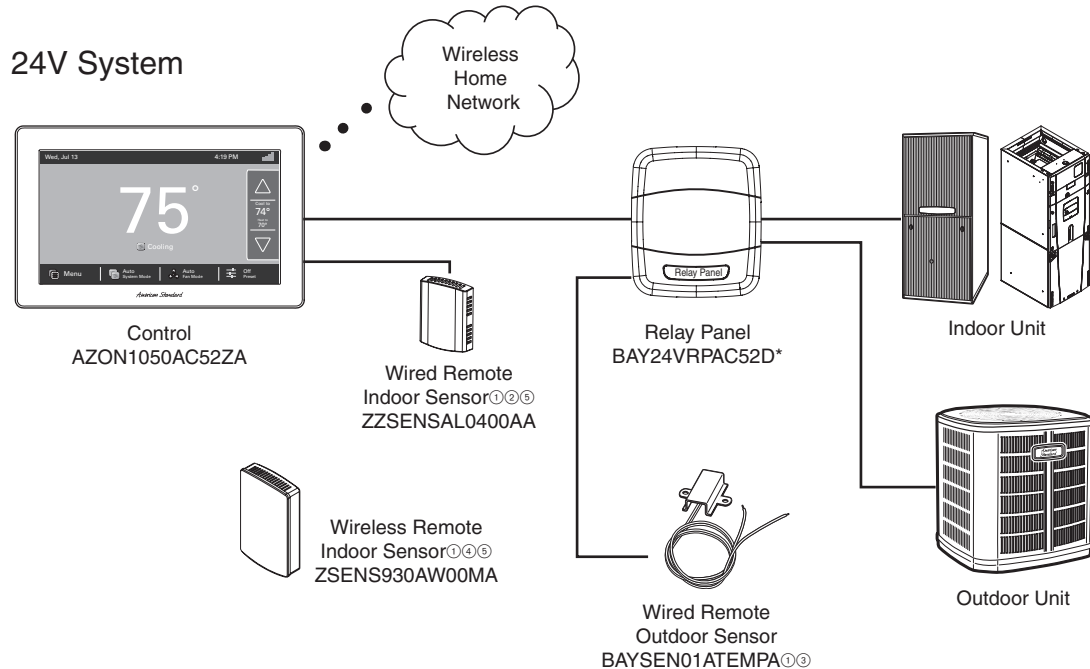

- ① Optional Accessory
- ② Can alternatively be connected to the Relay Panel
- ③ Can alternatively be connected to the 1050 Control
- ④ Z-wave sensor may be added to 1050 built in bridge
- ⑤ Use one wireless or wired sensor per zone

For complete equipment / combination selections, installation instructions and warranty information, please refer to Product Data/Ratings and/or Installers Guides and Limited Warranty Handbooks.

BUILT TO A HIGHER STANDARD

American Standard

HEATING & AIR CONDITIONING

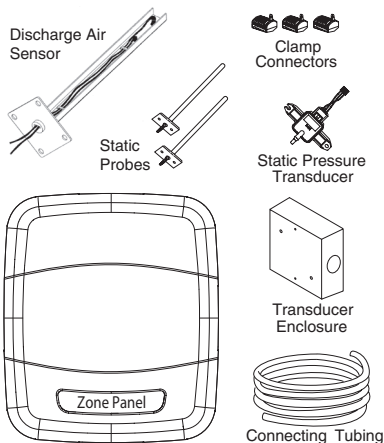

ZZONEPNLAC52ZB

AccuLink™ Zoning Assembly

ZZONEPNLAC52ZB American Standard Variable Speed Indoor Unit (Air handler/Gas Furnace) required.

Includes:

- Four Zone Communicating Zone Panel with discharge air sensor, static pressure transducer and housing, supply, return air static probes and connecting tubing, and three wiring blocks
- Automatically sets maximum CFM per zone
- Compatible with 24 volt systems with the addition of 24 volt relay panel
- Controls 24 volt power open, power close modulating dampers

- Auto detects installed dampers
- Supports 2-wire (ZZSENSAL0400AA) and 3-wire (AZONE940) zone sensors
- Adjustable damper motor travel times of 15 to 60 seconds
- Requires field supplied 24 volt power supply
- Up to four 1.5 VA dampers can be wired in parallel to each zone
- Backlit LCD display for easy setup and service
- Removable low voltage terminal blocks for easy service and replacement

AccuLink™ Zone Expander Panel (Required with more than 4 zones)

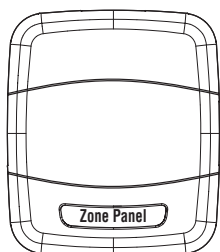

ZZONEEXPAC52ZB

ZZONEEXPAC52ZA*

- Expands the maximum number of zones per system to eight
- Controls 24 volt power open, power close modulating dampers
- Auto detects installed dampers
- Supports 2-wire (ZZSENSAL0400AA) and 3-wire (AZONE940) zone sensors
- Adjustable damper motor travel times of 15 to 60 seconds
- Requires field supplied 24 volt power supply

Dimensions:

- 8.0" width x 9.3" height x 1.9" depth

Storage Temperature:

- -40° to 175°F, 5% to 95% RH non-condensing

Operating Temperature:

- -40° to 150°F, 5% to 95% RH non-condensing

*This is the same Zone Panel that ships as part of the Zoning Assembly

AccuLink™ Zoning Component Overview

Zoned Communicating System

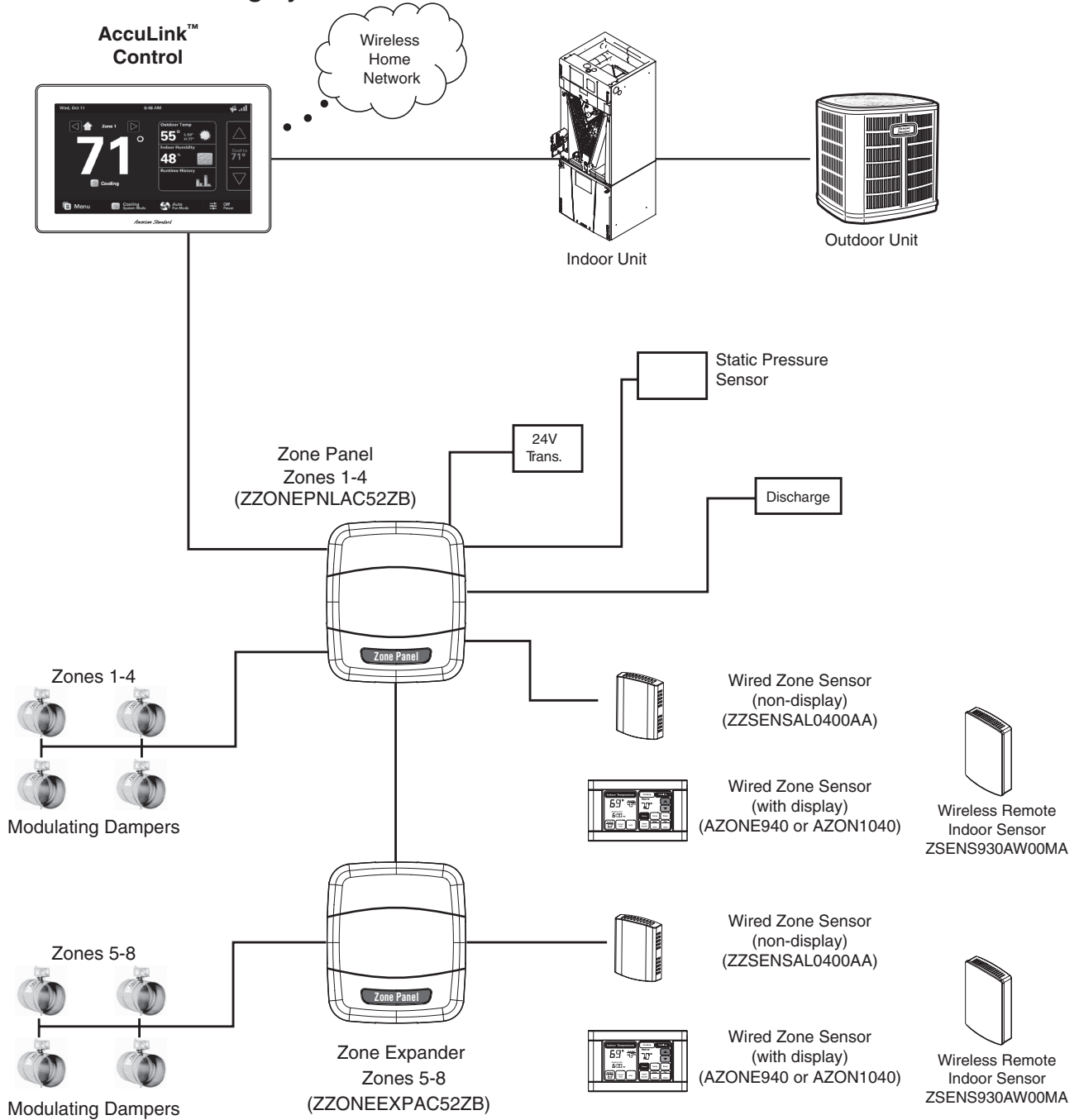

- Note 1. Each Zone Panel or Zone Expander supports up to four zones.
 - Note 2. One 940 or 1040 may be installed per zone.
 - Note 3. Up to four 0400 wired sensors or 930 wireless sensors may be installed per zone.
 - Note 4. If a 940 or 1050 is used, then up to three 0400 wired sensors or 930 wireless sensors may be installed per zone.
 - Note 5. To apply up to four sensors per zone, software version 5,4 or higher is required.]
- Example: One 940, two 930, and one 0400 may be installed per zone.

For complete equipment / combination selections, installation instructions and warranty information, please refer to Product Data/Ratings and/or Installers Guides and Limited Warranty Handbooks.

AccuLink™ Zoning Component Overview (Cont.)

Zoned 24V System

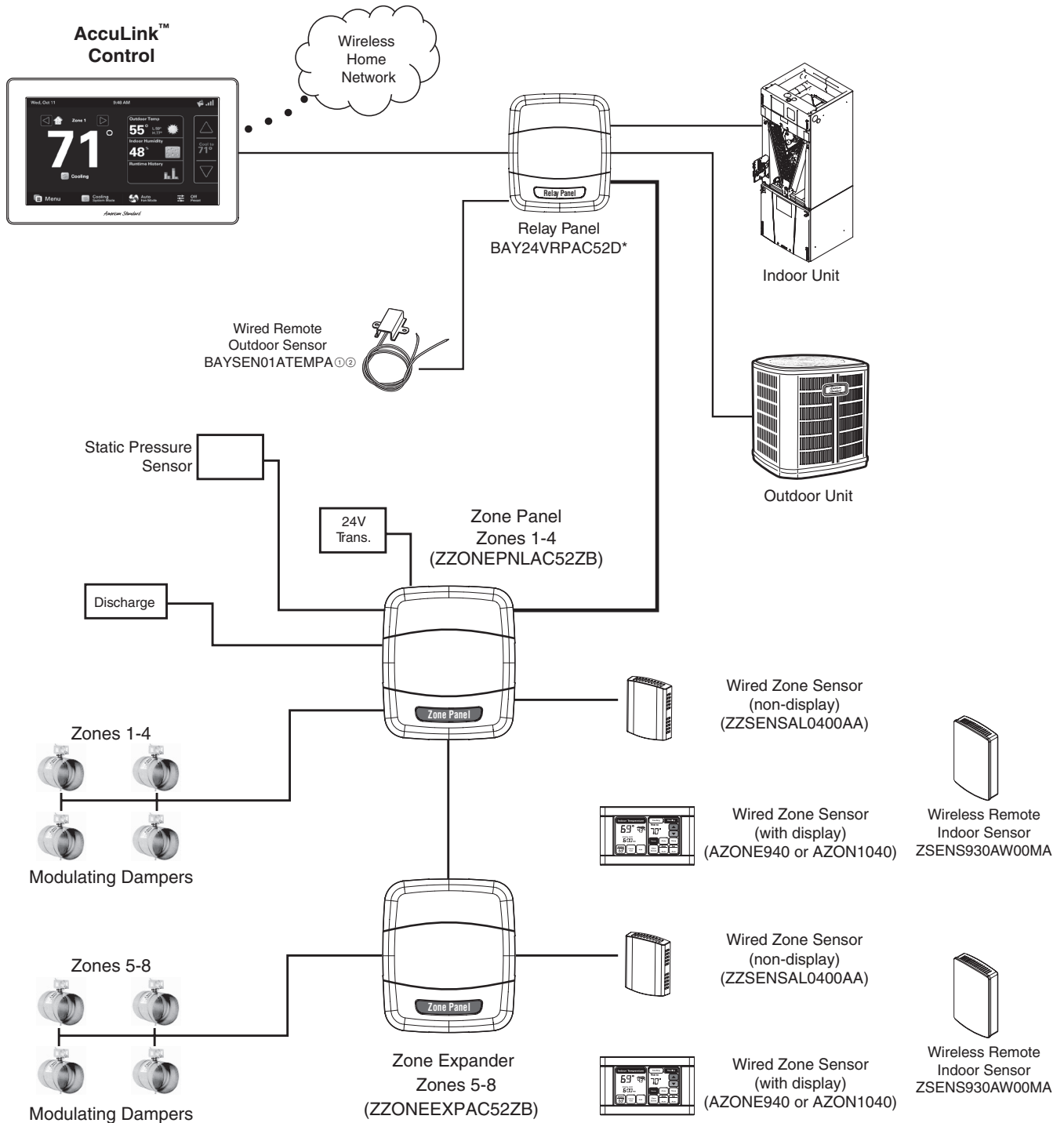

- Note 1. Each Zone Panel or Zone Expander supports up to four zones.
 - Note 2. One 940 or 1040 may be installed per zone.
 - Note 3. Up to four 0400 wired sensors or 930 wireless sensors may be installed per zone.
 - Note 4. If a 940 or 1050 is used, then up to three 0400 wired sensors or 930 wireless sensors may be installed per zone.
 - Note 5. To apply up to four sensors per zone, software version 5,4 or higher is required.]
- Example: One 940, two 930, and one 0400 may be installed per zone.

For complete equipment / combination selections, installation instructions and warranty information, please refer to Product Data/Ratings and/or Installers Guides and Limited Warranty Handbooks.

24 Volt Modulating Dampers

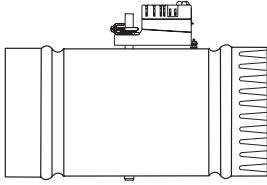

Round Dampers

Round Dampers

- 24 VAC Powered open/Powered closed
- Three wire connection - 18 gauge
- 1.5 VA damper actuator with 60 second travel time
- 18 in. lbs. of torque
- Manual gear release
- Screw terminal blocks
- Flexible shutoff seal provides 98% closure

Table CCZS-12-A — Specifications: Round Dampers

Model Number	Power Supply	Description	Fits Round Duct Size
ZDAMPRDMA0004A	24 VAC	Round	4"
ZDAMPRDMA0006A	24 VAC	Round	6"
ZDAMPRDMA0007A	24 VAC	Round	7"
ZDAMPRDMA0008A	24 VAC	Round	8"
ZDAMPRDMA0009A	24 VAC	Round	9"
ZDAMPRDMA0010A	24 VAC	Round	10"
ZDAMPRDMA0012A	24 VAC	Round	12"
ZDAMPRDMA0014A	24 VAC	Round	14"
ZDAMPRDMA0016A	24 VAC	Round	16"
ZDAMPRDMA0018A	24 VAC	Round	18"
ZDAMPRDMA0020A	24 VAC	Round	20"

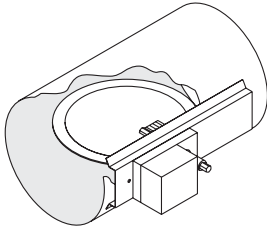

Retro-Fit Round Dampers

Retro-Fit Round Dampers

- 24 VAC Powered open/Powered closed
- Three wire connection - 18 gauge
- Slip-In-Design installs quickly
- 1.5 VA damper actuator with 60 second travel time
- 18 in. lbs. of torque
- Manual gear release
- Screw terminal blocks
- Flexible shutoff seal provides 98% closure

Table CCZS-12-B — Specifications: Retrofit Round Dampers

Model Number	Power Supply	Description	Fits Round Duct Size
ZDAMPRRMA0004A	24 VAC	Retrofit Round	4"
ZDAMPRRMA0005A	24 VAC	Retrofit Round	5"
ZDAMPRRMA0006A	24 VAC	Retrofit Round	6"
ZDAMPRRMA0007A	24 VAC	Retrofit Round	7"
ZDAMPRRMA0008A	24 VAC	Retrofit Round	8"
ZDAMPRRMA0009A	24 VAC	Retrofit Round	9"
ZDAMPRRMA0010A	24 VAC	Retrofit Round	10"

24 Volt Modulating Dampers - Side Mount

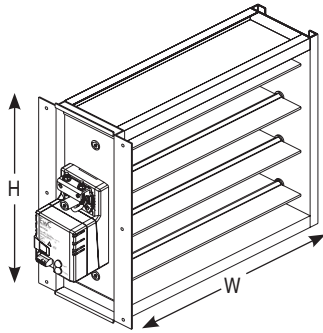

Rectangular Dampers with Side Mount Actuator

Rectangular Dampers with Side Mount Actuator

- 24 VAC Powered open/Powered closed
- Three wire connection - 18 gauge
- 1.5 VA damper actuator with 60 second travel time
- 18 in. lbs. of torque
- Manual gear release
- Screw terminal blocks
- 97% leak proof rating
- Sturdy aluminum blades and frame
- Motor is always located on the second dimension of the model number, i.e ZDAMP*MMA1012A will have the motor mounted on the 12" dimension

Table CCZS-13-A — Specifications: Rectangular Dampers with Side Mount Actuator

Model Number	Power Supply	Description	Uncrated Dimensions (in.)	
			W	H
ZDAMPSMMA0806A	24 VAC	Rectangular-Side Mount Actuator	8	6
ZDAMPSMMA0808A	24 VAC	Rectangular-Side Mount Actuator	8	8
ZDAMPSMMA1006A	24 VAC	Rectangular-Side Mount Actuator	10	6
ZDAMPSMMA1008A	24 VAC	Rectangular-Side Mount Actuator	10	8
ZDAMPSMMA1010A	24 VAC	Rectangular-Side Mount Actuator	10	10
ZDAMPSMMA1206A	24 VAC	Rectangular-Side Mount Actuator	12	6
ZDAMPSMMA1208A	24 VAC	Rectangular-Side Mount Actuator	12	8
ZDAMPSMMA1210A	24 VAC	Rectangular-Side Mount Actuator	12	10
ZDAMPSMMA1212A	24 VAC	Rectangular-Side Mount Actuator	12	12
ZDAMPSMMA1406A	24 VAC	Rectangular-Side Mount Actuator	14	6
ZDAMPSMMA1408A	24 VAC	Rectangular-Side Mount Actuator	14	8
ZDAMPSMMA1410A	24 VAC	Rectangular-Side Mount Actuator	14	10
ZDAMPSMMA1412A	24 VAC	Rectangular-Side Mount Actuator	14	12
ZDAMPSMMA1414A	24 VAC	Rectangular-Side Mount Actuator	14	14
ZDAMPSMMA1606A	24 VAC	Rectangular-Side Mount Actuator	16	6
ZDAMPSMMA1608A	24 VAC	Rectangular-Side Mount Actuator	16	8
ZDAMPSMMA1610A	24 VAC	Rectangular-Side Mount Actuator	16	10
ZDAMPSMMA1612A	24 VAC	Rectangular-Side Mount Actuator	16	12
ZDAMPSMMA1614A	24 VAC	Rectangular-Side Mount Actuator	16	14
ZDAMPSMMA1616A	24 VAC	Rectangular-Side Mount Actuator	16	16
ZDAMPSMMA1806A	24 VAC	Rectangular-Side Mount Actuator	18	6
ZDAMPSMMA1808A	24 VAC	Rectangular-Side Mount Actuator	18	8
ZDAMPSMMA1810A	24 VAC	Rectangular-Side Mount Actuator	18	10
ZDAMPSMMA1812A	24 VAC	Rectangular-Side Mount Actuator	18	12
ZDAMPSMMA1814A	24 VAC	Rectangular-Side Mount Actuator	18	14
ZDAMPSMMA1816A	24 VAC	Rectangular-Side Mount Actuator	18	16
ZDAMPSMMA1818A	24 VAC	Rectangular-Side Mount Actuator	18	18
ZDAMPSMMA2006A	24 VAC	Rectangular-Side Mount Actuator	20	6
ZDAMPSMMA2008A	24 VAC	Rectangular-Side Mount Actuator	20	8
ZDAMPSMMA2010A	24 VAC	Rectangular-Side Mount Actuator	20	10
ZDAMPSMMA2012A	24 VAC	Rectangular-Side Mount Actuator	20	12
ZDAMPSMMA2014A	24 VAC	Rectangular-Side Mount Actuator	20	14
ZDAMPSMMA2016A	24 VAC	Rectangular-Side Mount Actuator	20	16
ZDAMPSMMA2018A	24 VAC	Rectangular-Side Mount Actuator	20	18
ZDAMPSMMA2020A	24 VAC	Rectangular-Side Mount Actuator	20	20

24 Volt Modulating Dampers - Side Mount

Table CCZS-14-A — Specifications: Rectangular Dampers with Side Mount Actuator (continued)

Model Number	Power Supply	Description	Uncrated Dimensions (in.)	
			W	H
ZDAMPSMMA2206A	24 VAC	Rectangular-Side Mount Actuator	22	6
ZDAMPSMMA2208A	24 VAC	Rectangular-Side Mount Actuator	22	8
ZDAMPSMMA2210A	24 VAC	Rectangular-Side Mount Actuator	22	10
ZDAMPSMMA2212A	24 VAC	Rectangular-Side Mount Actuator	22	12
ZDAMPSMMA2214A	24 VAC	Rectangular-Side Mount Actuator	22	14
ZDAMPSMMA2216A	24 VAC	Rectangular-Side Mount Actuator	22	16
ZDAMPSMMA2218A	24 VAC	Rectangular-Side Mount Actuator	22	18
ZDAMPSMMA2220A	24 VAC	Rectangular-Side Mount Actuator	22	20
ZDAMPSMMA2222A	24 VAC	Rectangular-Side Mount Actuator	22	22
ZDAMPSMMA2406A	24 VAC	Rectangular-Side Mount Actuator	24	6
ZDAMPSMMA2408A	24 VAC	Rectangular-Side Mount Actuator	24	8
ZDAMPSMMA2410A	24 VAC	Rectangular-Side Mount Actuator	24	10
ZDAMPSMMA2412A	24 VAC	Rectangular-Side Mount Actuator	24	12
ZDAMPSMMA2414A	24 VAC	Rectangular-Side Mount Actuator	24	14
ZDAMPSMMA2416A	24 VAC	Rectangular-Side Mount Actuator	24	16
ZDAMPSMMA2418A	24 VAC	Rectangular-Side Mount Actuator	24	18
ZDAMPSMMA2420A	24 VAC	Rectangular-Side Mount Actuator	24	20
ZDAMPSMMA2422A	24 VAC	Rectangular-Side Mount Actuator	24	22
ZDAMPSMMA2424A	24 VAC	Rectangular-Side Mount Actuator	24	24
ZDAMPSMMA2606A	24 VAC	Rectangular-Side Mount Actuator	26	6
ZDAMPSMMA2608A	24 VAC	Rectangular-Side Mount Actuator	26	8
ZDAMPSMMA2610A	24 VAC	Rectangular-Side Mount Actuator	26	10
ZDAMPSMMA2612A	24 VAC	Rectangular-Side Mount Actuator	26	12
ZDAMPSMMA2614A	24 VAC	Rectangular-Side Mount Actuator	26	14
ZDAMPSMMA2616A	24 VAC	Rectangular-Side Mount Actuator	26	16
ZDAMPSMMA2618A	24 VAC	Rectangular-Side Mount Actuator	26	18
ZDAMPSMMA2620A	24 VAC	Rectangular-Side Mount Actuator	26	20
ZDAMPSMMA2622A	24 VAC	Rectangular-Side Mount Actuator	26	22
ZDAMPSMMA2624A	24 VAC	Rectangular-Side Mount Actuator	26	24
ZDAMPSMMA2626A	24 VAC	Rectangular-Side Mount Actuator	26	26
ZDAMPSMMA2806A	24 VAC	Rectangular-Side Mount Actuator	28	6
ZDAMPSMMA2808A	24 VAC	Rectangular-Side Mount Actuator	28	8
ZDAMPSMMA2810A	24 VAC	Rectangular-Side Mount Actuator	28	10
ZDAMPSMMA2812A	24 VAC	Rectangular-Side Mount Actuator	28	12
ZDAMPSMMA2814A	24 VAC	Rectangular-Side Mount Actuator	28	14
ZDAMPSMMA2816A	24 VAC	Rectangular-Side Mount Actuator	28	16
ZDAMPSMMA2818A	24 VAC	Rectangular-Side Mount Actuator	28	18
ZDAMPSMMA2820A	24 VAC	Rectangular-Side Mount Actuator	28	20
ZDAMPSMMA2822A	24 VAC	Rectangular-Side Mount Actuator	28	22
ZDAMPSMMA2824A	24 VAC	Rectangular-Side Mount Actuator	28	24
ZDAMPSMMA2826A	24 VAC	Rectangular-Side Mount Actuator	28	26
ZDAMPSMMA2828A	24 VAC	Rectangular-Side Mount Actuator	28	28
ZDAMPSMMA3006A	24 VAC	Rectangular-Side Mount Actuator	28	6
ZDAMPSMMA3008A	24 VAC	Rectangular-Side Mount Actuator	28	8
ZDAMPSMMA3010A	24 VAC	Rectangular-Side Mount Actuator	28	10
ZDAMPSMMA3012A	24 VAC	Rectangular-Side Mount Actuator	28	12
ZDAMPSMMA3014A	24 VAC	Rectangular-Side Mount Actuator	28	14
ZDAMPSMMA3016A	24 VAC	Rectangular-Side Mount Actuator	28	16
ZDAMPSMMA3018A	24 VAC	Rectangular-Side Mount Actuator	28	18
ZDAMPSMMA3020A	24 VAC	Rectangular-Side Mount Actuator	28	20
ZDAMPSMMA3022A	24 VAC	Rectangular-Side Mount Actuator	28	22
ZDAMPSMMA3024A	24 VAC	Rectangular-Side Mount Actuator	28	24
ZDAMPSMMA3026A	24 VAC	Rectangular-Side Mount Actuator	28	26
ZDAMPSMMA3028A	24 VAC	Rectangular-Side Mount Actuator	28	28
ZDAMPSMMA3030A	24 VAC	Rectangular-Side Mount Actuator	28	30

24 Volt Modulating Dampers - Bottom Mount

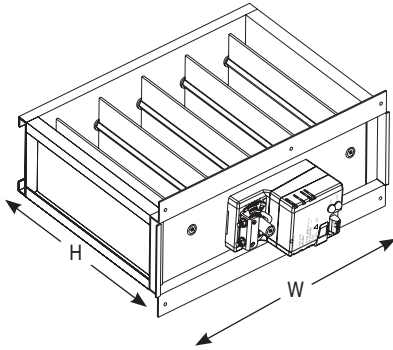

Rectangular Dampers with Bottom Mount Actuator

Rectangular Dampers with Bottom Mount Actuator

- 24 VAC Powered open/Powered closed
- Three wire connection - 18 gauge
- 1.5 VA damper actuator with 60 second travel time
- 18 in. lbs. of torque
- Manual gear release
- Screw terminal blocks
- 97% leak proof rating
- Sturdy aluminum blades and frame
- Motor is always located on the second dimension of the model number, i.e. ZDAMP*MMA1012A will have the motor mounted on the 12" dimension

Table CCZS-15-A — Specifications: Rectangular Dampers with Bottom Mount Actuator

Model Number	Power Supply	Description	Uncrated Dimensions (in.)	
			H	W
ZDAMPBMMMA0810A	24 VAC	Rectangular-Bottom Mount Actuator	8	10
ZDAMPBMMMA0812A	24 VAC	Rectangular-Bottom Mount Actuator	8	12
ZDAMPBMMMA0814A	24 VAC	Rectangular-Bottom Mount Actuator	8	14
ZDAMPBMMMA0816A	24 VAC	Rectangular-Bottom Mount Actuator	8	16
ZDAMPBMMMA0818A	24 VAC	Rectangular-Bottom Mount Actuator	8	18
ZDAMPBMMMA0820A	24 VAC	Rectangular-Bottom Mount Actuator	8	20
ZDAMPBMMMA0822A	24 VAC	Rectangular-Bottom Mount Actuator	8	22
ZDAMPBMMMA0824A	24 VAC	Rectangular-Bottom Mount Actuator	8	24
ZDAMPBMMMA0826A	24 VAC	Rectangular-Bottom Mount Actuator	8	26
ZDAMPBMMMA0828A	24 VAC	Rectangular-Bottom Mount Actuator	8	28
ZDAMPBMMMA0830A	24 VAC	Rectangular-Bottom Mount Actuator	8	30
ZDAMPBMMMA1012A	24 VAC	Rectangular-Bottom Mount Actuator	10	12
ZDAMPBMMMA1014A	24 VAC	Rectangular-Bottom Mount Actuator	10	14
ZDAMPBMMMA1016A	24 VAC	Rectangular-Bottom Mount Actuator	10	16
ZDAMPBMMMA1018A	24 VAC	Rectangular-Bottom Mount Actuator	10	18
ZDAMPBMMMA1020A	24 VAC	Rectangular-Bottom Mount Actuator	10	20
ZDAMPBMMMA1022A	24 VAC	Rectangular-Bottom Mount Actuator	10	22
ZDAMPBMMMA1024A	24 VAC	Rectangular-Bottom Mount Actuator	10	24
ZDAMPBMMMA1026A	24 VAC	Rectangular-Bottom Mount Actuator	10	26
ZDAMPBMMMA1028A	24 VAC	Rectangular-Bottom Mount Actuator	10	28
ZDAMPBMMMA1030A	24 VAC	Rectangular-Bottom Mount Actuator	10	30
ZDAMPBMMMA1214A	24 VAC	Rectangular-Bottom Mount Actuator	12	14
ZDAMPBMMMA1216A	24 VAC	Rectangular-Bottom Mount Actuator	12	16
ZDAMPBMMMA1218A	24 VAC	Rectangular-Bottom Mount Actuator	12	18
ZDAMPBMMMA1220A	24 VAC	Rectangular-Bottom Mount Actuator	12	20
ZDAMPBMMMA1222A	24 VAC	Rectangular-Bottom Mount Actuator	12	22
ZDAMPBMMMA1224A	24 VAC	Rectangular-Bottom Mount Actuator	12	24
ZDAMPBMMMA1226A	24 VAC	Rectangular-Bottom Mount Actuator	12	26
ZDAMPBMMMA1228A	24 VAC	Rectangular-Bottom Mount Actuator	12	28
ZDAMPBMMMA1230A	24 VAC	Rectangular-Bottom Mount Actuator	12	30
ZDAMPBMMMA1416A	24 VAC	Rectangular-Bottom Mount Actuator	14	16
ZDAMPBMMMA1418A	24 VAC	Rectangular-Bottom Mount Actuator	14	18
ZDAMPBMMMA1420A	24 VAC	Rectangular-Bottom Mount Actuator	14	20
ZDAMPBMMMA1422A	24 VAC	Rectangular-Bottom Mount Actuator	14	22
ZDAMPBMMMA1424A	24 VAC	Rectangular-Bottom Mount Actuator	14	24
ZDAMPBMMMA1426A	24 VAC	Rectangular-Bottom Mount Actuator	14	26
ZDAMPBMMMA1428A	24 VAC	Rectangular-Bottom Mount Actuator	14	28
ZDAMPBMMMA1430A	24 VAC	Rectangular-Bottom Mount Actuator	14	30
ZDAMPBMMMA1618A	24 VAC	Rectangular-Bottom Mount Actuator	16	18
ZDAMPBMMMA1620A	24 VAC	Rectangular-Bottom Mount Actuator	16	20
ZDAMPBMMMA1622A	24 VAC	Rectangular-Bottom Mount Actuator	16	22
ZDAMPBMMMA1624A	24 VAC	Rectangular-Bottom Mount Actuator	16	24
ZDAMPBMMMA1626A	24 VAC	Rectangular-Bottom Mount Actuator	16	26
ZDAMPBMMMA1628A	24 VAC	Rectangular-Bottom Mount Actuator	16	28
ZDAMPBMMMA1630A	24 VAC	Rectangular-Bottom Mount Actuator	16	30
ZDAMPBMMMA1820A	24 VAC	Rectangular-Bottom Mount Actuator	18	20
ZDAMPBMMMA1822A	24 VAC	Rectangular-Bottom Mount Actuator	18	22
ZDAMPBMMMA1824A	24 VAC	Rectangular-Bottom Mount Actuator	18	24
ZDAMPBMMMA1826A	24 VAC	Rectangular-Bottom Mount Actuator	18	26
ZDAMPBMMMA2022A	24 VAC	Rectangular-Bottom Mount Actuator	20	22
ZDAMPBMMMA2024A	24 VAC	Rectangular-Bottom Mount Actuator	20	24

BUILT TO A HIGHER STANDARD[®]

American Standard[®]

HEATING & AIR CONDITIONING

24 Volt Modulating Dampers

Table CCZS-16-A — Rectangular Damper Net Free Area

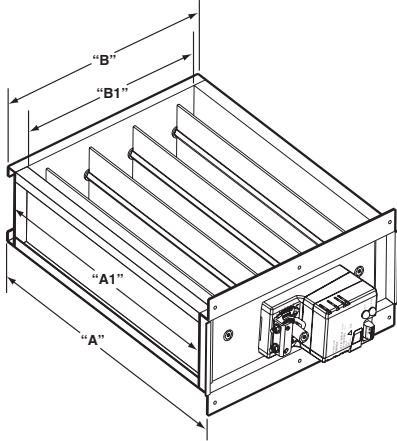

Listed Size Wide	Actual Outside Size A	Actual Inside Size A1	8	10	12	14	16	18	20	22	24	26	28	30	Listed Size High	
			7.813	9.813	11.813	13.813	15.813	17.813	19.813	21.813	23.813	25.813	27.813	29.813	29.813	Act. Outside Size B
			5.813	7.813	9.813	11.813	13.813	15.813	17.813	19.813	21.813	23.813	25.813	27.813	27.813	Act. Inside Size B1
			3	3	4	5	6	7	7	8	9	10	11	11	No. of Blades	
6	5.812	4.313	19.5	28.1	34.9	41.6	48.6	55.1	63.8	70.5	77.3	84.0	90.8	99.4		
8	7.812	6.313	28.5	41.1	51.0	60.9	70.8	80.7	93.3	103.2	113.1	123.0	132.9	145.5		
10	9.812	8.313	37.5	54.2	67.2	80.2	93.2	106.3	122.9	135.9	148.9	162.0	175.0	191.6		
12	11.812	10.313	46.5	67.2	83.3	99.5	115.7	131.8	152.5	168.6	184.8	200.9	217.1	237.7		
14	13.812	12.313	55.6	80.2	99.5	118.8	138.1	157.4	182.0	201.3	220.6	239.9	259.2	283.8		
16	15.812	14.313	64.6	93.2	115.7	138.1	160.5	183.0	211.6	234.0	256.4	278.9	301.3	329.9		
18	17.812	16.313	73.6	106.3	131.8	157.4	183.0	208.5	241.1	266.7	292.3	317.8	343.4	376.0		
20	19.812	18.313	82.7	119.3	148.0	176.7	205.4	234.1	270.7	299.4	328.1	356.8	385.5	422.1		
22	21.812	20.313	91.7	132.3	164.2	196.0	227.8	259.6	300.3	332.1	363.9	395.8	427.6	468.2		
24	23.812	22.313	100.7	145.4	180.3	215.3	250.2	285.2	329.8	364.8	399.8	435.2	469.7	514.3		
26	25.812	24.313	109.8	158.4	196.5	234.6	272.7	310.8	359.4	397.5	435.6	473.7	511.8	560.4		
28	27.812	26.313	118.8	171.4	212.6	253.9	295.1	336.3	389.0	430.2	471.4	512.7	553.8	606.5		
30	29.812	28.313	127.8	184.4	228.8	273.2	317.5	361.9	418.5	462.9	507.3	551.6	596.0	652.6		

BUILT TO A HIGHER STANDARD[®]

American Standard[®]
HEATING & AIR CONDITIONING

Programmable Touchscreen Thermostats

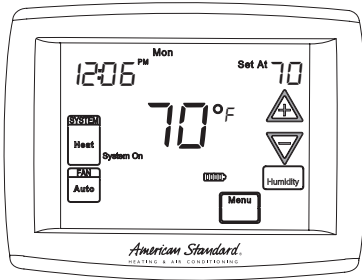

ACONT303AS42DA

ACONT303AS42DA

- 5" Diagonal Touchscreen
- Built-in Humidity sensor
- Programmable: 7 day, 5/1/1 day, or none
- Common preferred, not required with 2AA battery power (included)
- Simple to install and use
- 5" diagonal touchscreen
- Remote wired indoor or outdoor sensor option
- Control with one indoor sensor or average with thermostat internal sensor
- Armchair Programming (requires batteries)
- Cooling dehumidification (DHM) (normally closed relay; opens, 24V to BK)
- Humidifier Relay (HM)

Application:

- Up to 4 Heat/2 Cool (Gas, Oil or Electric) / HP / Dual Fuel
- ZZSENSAL0300AA - Remote Indoor Temperature Sensor
- BAYSEN30ATEMPA - Remote Outdoor Temperature Sensor

Dimensions:

- 4.56" h x 5.81" h x 1.18" d
- Finish: Bright White

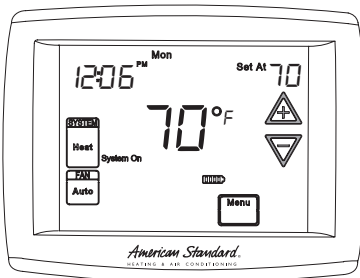

ACONT302AS42DA

ACONT302AS42DA

- 5" Diagonal Touchscreen
- Programmable: 7 day, 5/1/1 day, or none
- Common preferred, not required with 2AA battery power (included)
- Simple to install and use
- 5" diagonal touchscreen
- Remote wired indoor or outdoor sensor option
- Control with one indoor sensor or average with thermostat internal sensor
- Armchair Programming (requires batteries)

Application:

- Up to 4 Heat/2 Cool (Gas, Oil or Electric) / HP / Dual Fuel
- ZZSENSAL0300AA - Remote Indoor Temperature Sensor
- BAYSEN30ATEMPA - Remote Outdoor Temperature Sensor

Dimensions:

- 4.56" h x 5.81" h x 1.18" d
- Finish: Bright White

For complete equipment / combination selections, installation instructions and warranty information, please refer to Product Data/Ratings and/or Installers Guides and Limited Warranty Handbooks.

CCZS-17

Effective 1/1/20
14-1011-37

BUILT TO A HIGHER STANDARD[®]

American Standard[®]
HEATING & AIR CONDITIONING

Programmable Thermostats

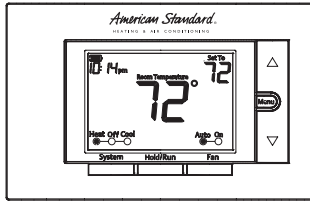

ACONT203AS42MA

ACONT203AS42MA

4 Heat/2 Cool

- 5/1/1 or 7 day Programming
- Simple to Install and Use
- 3.5" Diagonal, Backlit Display
- Common preferred, not required with 2AA battery power (included)
- Easy to follow Sequential Programming
- Indoor and setpoint temperatures displayed simultaneously
- Easy battery access
- Easy to understand soft key controls

Application:

- Up to 4 Heat/2 Cool (Gas, Oil or Electric) / HP / Dual Fuel (non-restricted mode only)

Dimensions:

- 3.75" h x 6.0" w x 1.12" d
- Finish: Bright White

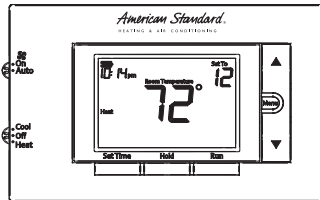

ACONT202AS11MA

ACONT202AS11MA

1 Heat/1 Cool

- 5/1/1 or 7 day Programming
- Simple to Install and Use
- 3.5" Diagonal, Backlit Display
- Common preferred, not required with 2AA battery power (included)
- Standard Wiring Terminal Block
- Easy to follow Sequential Programming
- Indoor and setpoint temperatures displayed simultaneously
- No auxiliary heat capability
- Easy battery access
- Easy to understand soft key controls

Application:

- 1 Heat/1 Cool

Dimensions:

- 3.75" h x 6.0" w x 1.12" d
- Finish: Bright White

BUILT TO A HIGHER STANDARD

American Standard
HEATING & AIR CONDITIONING

Programmable 7 Day Comfort Controls

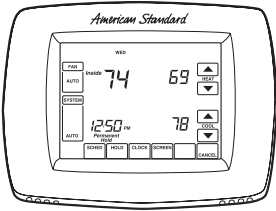

ACONT800A

ACONT800AS11AA

- Interactive Touchscreen
- Effortless Programming
- Large, Backlit Display
- Streamlined Design
- Armchair Programming
- Real Time Clock
- Visual Reminder Cues
- BAYCOVR600A - Wall cover plate
- Energy Saver

Application:

- 1 Heat/1 Cool (Gas, Oil or Electric)
- 1 Heat/0 Cool (Gas, Oil or Electric)
- 0 Heat/1 Cool
- ZZSENSAL0800AA - Remote Indoor Temperature Sensor

Dimensions:

- 6.02" w x 4.62" h x 1.35" d
- Finish: Bright White

* Available until inventory runs out

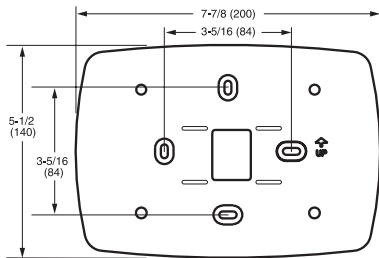

BAYCOVR600A

BAYCOVR600A

Application:

- Use with ACONT800/900A Series Comfort Controls

Dimensions:

- 7.87" w x 5.50" h
- Finish: Bright White

* Available until inventory runs out

Non-Programmable Comfort Controls

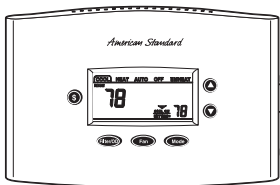

ACONT402A

ACONT402AN32DA

- Auto Changeover
- Backlit Display & Keys
- Comfort Information Compartment
- Energy Savings Mode
- Filter Reminder
- BAYSEN01ATEMPAA-Outdoor Temperature Sensor included*
- Keypad Lock

Application (3-9 Wire Hookup -2 for Outdoor Sensor) Heat Pump* or A/C

3 Heat/2 Cool

No external Dual Fuel Kit Required

Do not use with TAYPLUS103A

ZZSENSAL0400AA - Remote Indoor Temperature Sensor

Dimensions:

6.75" w x 4.52" h x 1.20" d

Finish: Bright White

* Requires external relay for oil furnace applications.

* Installation is required for outdoor temperature sensing and display

For complete equipment / combination selections, installation instructions and warranty information, please refer to Product Data/Ratings and/or Installers Guides and Limited Warranty Handbooks.

CCZS-19

Effective 1/1/20
14-1011-37

Comfort Controls/Zone Sensors

BUILT TO A HIGHER STANDARD[®]

American Standard[®]

HEATING & AIR CONDITIONING

Non-Programmable Thermostats

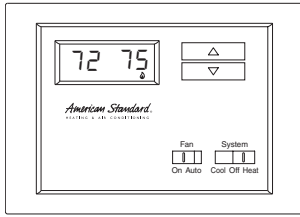

ACONT103A

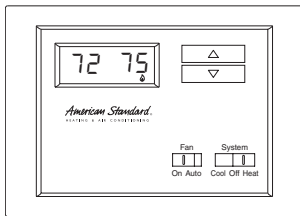

ACONT102A

ACONT103AN21MA

2 Heat/1 Cool

- Push Button, Non-Programmable
- 1.9" Diagonal Display
- Configurable Switchover Valve
- Emergency Heat
- Common required
- Fahrenheit or Celcius
- Keypad Lock

Application

- Up to 2 Heat/1Cool (HP only)
- 1 Stage Compressor
- 1 Stage Auxiliary Heat

Dimensions:

- 3.88" h x 5.5" h x 1.18" d
- Finish: Bright White

ACONT102AN11AA

1 Heat/1 Cool

- Push Button, Non-Programmable
- 1.9" Diagonal Display
- No Common Terminal
- Battery Powered Only (Batteries included)
- RH / RC Jumper
- Fahrenheit or Celcius

Application

- Up to 1Heat/1 Cool (Gas, Oil or Electric)
- Finish: Bright White

Dimensions:

- 3.88" h x 5.5" h x 1.18" d
- Finish: Bright White

Remote Sensors



BAYSEN02ATEMPA

- Outdoor Temperature Sensor for use with ACONT800, 802, 803
- Accuracy +/- 1°F from -40 to 120°F

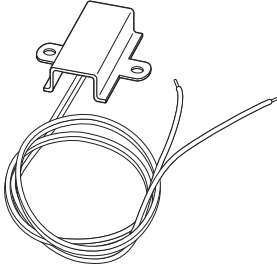

BAYSEN01ATEMPA

- Outdoor Temperature Sensor for use with AZON1050AC, AZONE950AC, ACONT850AC, ACONT824AS, ACONT624AS, ACONT402AN, ACONT401AN, BAY24VRPAC52D*
- Accuracy
 - +/- 1.5°F over 32°F to 100°F
- Display Range
 - -40°F to 140°F

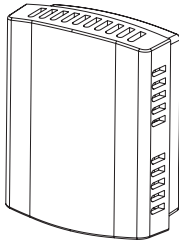

ZZSENSAL0400AA

- Indoor Wired Sensor for use with AZON1050AC, AZONE950AC, ACONT850AC, ACONT824AS, ACONT624AS, ACONT402AN, BAY24VRPAC52D*
- Operating Ambient Temperature Range: 20° to 120°F (-6.7° to 48.9°C)
- Display Range: 20° to 120°F (-6.7° to 48.9°C)
- Sensor Accuracy: +/- .5°F at 75°F
- Operating Relative Humidity: 5% to 90% non-condensing

Dimensions in in. (mm):

- 1.54 (39)w x 1.93 (49)h x .625 (1.6)d
- Storage Temperature: -40° to 140°F (-40° to 60°C)
- Finish: White

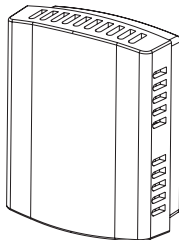

ZZSENSAL0800AA

- Indoor Wired Temperature Sensor for use with ACONT800, ACONT802, ACONT803
- Operating Ambient Temperature Range: 20° to 120°F (-6.7° to 48.9°C)
- Display Range: 0 to 99°F (-18 to 37°C)
- Sensor Accuracy: +/-1.5°F at 70°F (+/- .84 at 21°C)
- Operating Relative Humidity: 5% to 95% non-condensing

Dimensions in in. (mm):

- 1.54 (39)w x 1.93 (49)h x .625 (16)d
- Storage Temperature: -40° to 140°F (-40° to 60°C)
- Finish: White

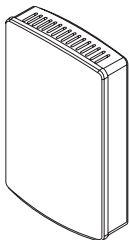

ZSENS930AW00MA

- Indoor Wireless Temperature and Humidity Sensor for use with ACONT824, ACONT850, AZON1050
- Operating Ambient Temperature Range: 32° to 104°F (0° to 40°C)
- Power Supply: Two AAA alkaline batteries
- Sensor Accuracy: +/-1°F over the sensing range of 32°F to 120°F (0° to 48.9°C)
- Operating Relative Humidity: 10% to 90% non-condensing

Dimensions in in. (mm):

- 2.0" (51)w x 3.25" (83)h x .6 (15)d
- Storage Temperature: -40° to 140°F (-40° to 65°C)
- Finish: White

Outdoor Thermostat Kit

TAYSTAT250B

- The outdoor thermostat (ODT) is designed to turn "ON" the supplementary heater at a pre-selected outdoor temperature.
- The number and setting of the ODT is dependent on the heat loss of the structure and capacity of the heating system installed.
- This model ODT gives a temperature range for 44°F. to -10°F. (See figure 1 for settings). The switching action is single pole/double throw, opening on temperature rise and closing on temperature fall, completing the circuit through the thermostat.

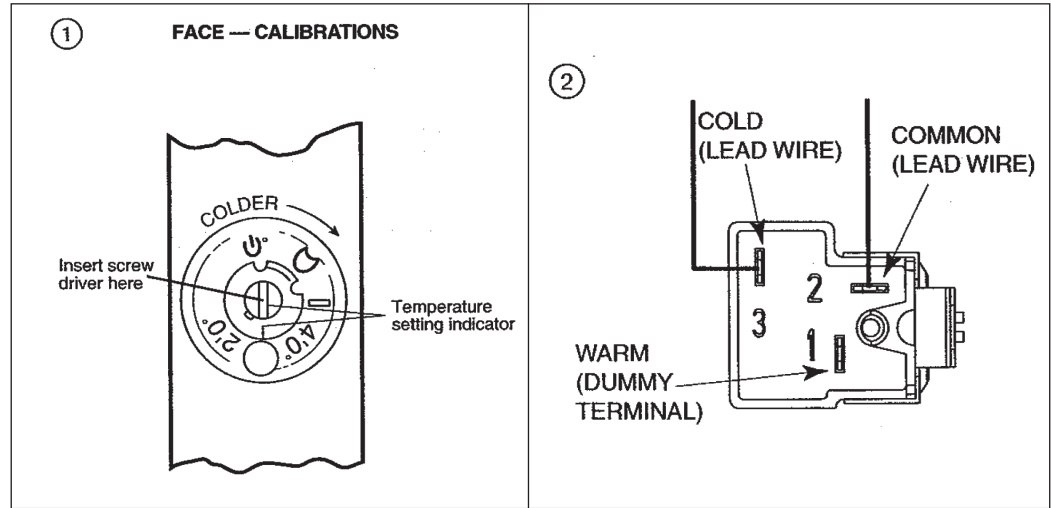

BUILT TO A HIGHER STANDARD™

American Standard®
HEATING & AIR CONDITIONING

Packaged Cooling Convertible 2-5 Tons

Packaged Cooling

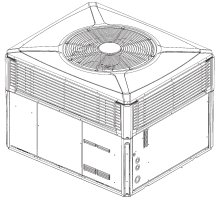

4TCY5

Table PK-1-A — 4TCY5 - Gold 15 - Convertible Packaged Cooling - R-410A

Model Number	Cooling Capacity (Btuh)	SEER/EER	Shipping Weight	MCA	Max Fuse	Sound Rating	Uncrated Dimensions (in.) H x D x W
4TCY5 – 208-230/1/60							
4TCY5024A1000A	23,800	15.00/12.00	388	18.4	25	65	36 x 42 x 49
4TCY5030A1000A	28,400	15.00/12.00	418	21.2	30	70	38 x 42 x 49
4TCY5036A1000A	36,000	15.00/12.00	422	23.8	35	69	38 x 42 x 49
4TCY5042A1000A	40,500	15.00/12.00	547	28.6	45	71	38 x 45 x 59
4TCY5048A1000A	48,000	15.00/12.00	570	34.2	50	71	42 x 45 x 59
4TCY5060A1000A	57,500	15.00/11.40	582	44.4	60	73	42 x 45 x 59

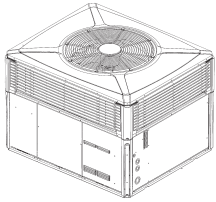

**4TCY4
(3-phase only)**

Table PK-1-B — 4TCY4 - Gold 14 - Convertible Packaged Cooling - R-410A

Model Number	Cooling Capacity (Btuh)	SEER/EER	Shipping Weight	MCA	Max Fuse	Sound Rating	Uncrated Dimensions (in.) H x D x W
4TCY4 – 208-230/3/60							
4TCY4036B3000A	38,000	14.20/12.00	450	19.8	30	69	38 x 42 x 49
4TCY4048B3000A	48,000	14.30/11.90	607	26.4	40	72	38 x 45 x 59
4TCY4060A3000B	60,000	14.30/12.00	612	30.6	45	76	42 x 45 x 59

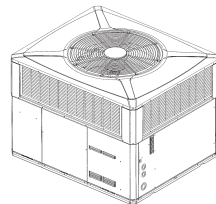

4TCC4

Table PK-1-C — 4TCC4 - Silver 14 - Convertible Packaged Cooling - R-410A

Model Number	Cooling Capacity (Btuh)	SEER/EER	Shipping Weight	MCA	Max Fuse	Sound Rating	Cabinet Dimensions (in.) H x D x W
4TCC4 – 208-230/1/60							
4TCC4024A1000A	24,600	14.00/12.00	432	19.1	30	67	36 x 42 x 49
4TCC4030A1000A	28,200	14.00/12.00	451	22.6	35	69	36 x 42 x 49
4TCC4036A1000A	37,000	14.00/12.00	453	24.5	40	69	38 x 42 x 49
4TCC4042A1000A	40,500	14.00/12.00	561	28.5	45	75	36 x 45 x 59
4TCC4048A1000A	46,500	14.00/11.50	557	32.0	50	73	40 x 45 x 59
4TCC4060A1000A	58,000	14.00/11.50	586	39.1	60	73	40 x 45 x 59

For dimensional/outline drawings, please refer to Product Data.

For information on Roof Curbs, please refer to the Accessories/Information Tab.

For complete equipment / combination selections, installation instructions and warranty information, please refer to Product Data/Ratings and/or Installers Guides and Limited Warranty Handbooks.

BUILT TO A HIGHER STANDARD[®]

American Standard[®]
HEATING & AIR CONDITIONING

Packaged Cooling Convertible 2-5 Tons

Table PK-2-A — Feature	4TCY5 2-5	4TCY4 3-5	4TCC4 2-5
• SEER up to	15.00	14.25	14.00
• Exclusive Duration [™] high efficiency compressor with internal overload protection.....	✓	✓	✓
• Factory supplied charge.....	R-410A	R-410A	R-410A
• Composite Vortica [®] indoor blower.....	✓	✓	✓
• Direct drive, variable speed ECM blower motor **.....	✓	✓	—
• Direct drive, multi-speed ECM blower motor (high efficiency)*.....	—	—	✓
• All aluminum Spine Fin [™] outdoor coil.....	✓	✓	✓
• Swept-blade outdoor fan for quiet operation.....	✓	✓	✓
• Architecturally integrated louvers and corner guards.....	✓	✓	—
• All steel louvers.....	—	—	✓
• Polyslate gray cabinet.....	✓	✓	✓
• Single stage cooling.....	2-3½	✓	✓
• Two stage cooling.....	4, 5	—	—
• High pressure cutout.....	✓	✓	✓
• Low pressure cutout.....	✓	✓	✓
• Liquid line drier - factory installed.....	✓	✓	✓
• Non-bleed expansion valves on indoor coil.....	✓	✓	✓
• Pressure taps, including liquid line taps, easily accessed and protected inside compressor compartment.....	✓	✓	✓
• Right side electrical service access for high and low voltage connections.....	✓	✓	✓
• Rugged steel basepan features deep drawn duct connections.....	✓	✓	✓
• Steeply sloped composite drainpan.....	✓	✓	✓
• Ships in horizontal configuration and converts quickly for downflow.....	✓	✓	✓
• Copper tube, aluminum fin indoor coil.....	3,4,& 5	✓	5
• All aluminum indoor coil.....	2, 2½, 3½	—	2-4
• All models are certified to UL 1995.....	✓	✓	✓
• 10-year compressor, 10-year coils & all other functional parts limited warranty (no registration required; Residential use)	✓	✓	✓
• Extended warranties available	✓	✓	✓

* Constant torque ECM (electronically commutated motor).
** Constant airflow ECM (electronically commutated motor).

**For dimensional/outline drawings, please refer to Product Data.
For information on Roof Curbs, please refer to the Accessories/Information Tab.**

For complete equipment / combination selections, installation instructions and warranty information, please refer to Product Data/Ratings and/or Installers Guides and Limited Warranty Handbooks.

Packaged Cooling Convertible 2-5 Tons

Table PK-3-A — Accessories

Model Number	Description	Shipping Weight	4TCY5 2-5	4TCY4 3-5	4TCC4 2-5
BAYACCDOR1A	Hinged Filter Access Door ^⑩		2-3	2-3	2-3
BAYACCDOR2A	Hinged Filter Access Door ^⑩		3½-5	3½-5	3½-5
BAYACCEADP1A	Adaptor Kit for Installation of AccuClean™ and 5" Media Filter (Horizontal) ^⑨	10	2-3	3	2-3
BAYACCEADP2A	Adaptor Kit for Installation of AccuClean™ and 5" Media Filter (Horizontal) ^⑨	12	3½-5	3½-5	3½-5
BAYADAP050A	Adapter Curb (Cabinet A/B).....		2-3	2-3	2-3
BAYADAP051A	Adapter Curb (Cabinet C).....		2-3	2-3	2-3
BAYADAP052A	Adapter Curb (Cabinet A/B).....		3½-5	3½-5	3½-5
BAYADAP053A	Adapter Curb (Cabinet C).....		3½-5	3½-5	3½-5
BAYADAP054A	Adapter Curb (Cabinet D).....		3½-5	3½-5	3½-5
BAYASCT001	Anti-Short Cycle Timer ^④		✓	✓	—
BAYCCHT102A	Crankcase Heater (230V) (Scroll).....		3½-5	3½-5	3½-5
BAYCCHT103A	Crankcase Heater (230V) (Scroll).....		2-3	3	2-3
BAYCOVR112A	12" Duct Shroud (Covers Horizontal Ducts) ^⑤		2-5	2-5	2-5
BAYCOVR118A	18" Duct Shroud (Covers Horizontal Ducts) ^⑤		2-5	2-5	2-5
BAYCURB050A	Flat Roof Full Perimeter Curb (Insulated).....	74	2-3	3	2-3
BAYCURB051A	Flat Roof Full Perimeter Curb (Insulated).....	74	3½-5	3½-5	3½-5
BAYDMPR101A	2-Position Motorized Fresh Air Damper ^{①⑥⑦⑧⑨}		2-3	2-3	2-3
BAYDMPR102A	2-Position Motorized Fresh Air Damper ^{①⑥⑦⑧⑨}		3½-5	3½-5	3½-5
BAYECON101A	Economizer with Barometric Relief (Downflow) ^{①②③④⑩}	50	2-3	2-3	2-3
BAYECON102A	Economizer with Barometric Relief (Downflow) ^{①②③④⑩}	65	3½-5	3½-5	3½-5
BAYECON104AB	Economizer with Barometric Relief (Downflow) ^{①②③④⑩}	65	4-5	—	—
BAYECON200A	Economizer (Horizontal) ^{①②③⑤}	85	2-3	2-3	2-3
BAYECON201A	Economizer (Horizontal) ^{①②③⑤}	85	3½	3½-5	3½-5
BAYECON204A	Economizer (Horizontal) ^{①②③⑤}	85	4-5	—	—
BAYENTH001A	Enthalpy Control Kit ^②	2	✓	✓	✓
BAYEXMK001A	Extreme Conditions Mounting Kit (Used on BAYCURB & BAYADAP).....		✓	✓	✓
BAYEXMK002B	Extreme Conditions Mounting Kit (Used on BAYUTIL).....		✓	✓	✓
BAYEXMK003A	Extreme Conditions Mounting Kit (Used on Slab Mounts).....		✓	✓	✓
BAYFLTR101C	1-2" Filter Frame (requires one 18x25 filter which is not included) ^①	6	2-3	2-3	2-3
BAYFLTR201C	1-2" Filter Frame (requires one 18x20 and one 18x18 filter which are not included) ^{①②}	6	3½-5	3½-5	3½-5
BAYLIFT002B	Lifting Lug Kit.....	5	✓	✓	✓
BAYLOAM011A	Evaporator Defrost Control Kit.....		✓	✓	✓
BAYLOAM105A	Low Ambient Control Kit.....	5	✓	✓	✓
BAYOSAH001A	Manual Fresh Air Damper ^①	6	2-3	2-3	2-3
BAYOSAH002A	Manual Fresh Air Damper ^①	8	3½-5	3½-5	3½-5
BAYQSTK300A	Start Kit (not factory installed).....		✓	—	✓
BAYSQRD001B	16" Round Duct Adapter ^⑩	5	2-3	2-3	2-3
BAYSQRD002B	18" Round Duct Adapter ^⑩	3	2-5	2-5	2-5
BAYUTIL101B	Roof Curb Utility Extension Kit.....		2-3	2-3	2-3
BAYUTIL102B	Roof Curb Utility Extension Kit.....		3½-5	3½-5	3½-5

- ① Must use filter frame when economizer/fresh air kit is used.
- ② Dry bulb control standard with economizer.
- ③ 2-Stage cooling control required when using economizer.
- ④ Do not use with electronic thermostats.
- ⑤ BAYCOVR112,118A will not cover BAYSQRD002B applications.
- ⑥ Does not contain barometric relief.
- ⑦ Max fresh air - 25%.
- ⑧ For non-continuous fan gas-heating applications, the damper opens only when the OD ambient is above 50° F.
- ⑨ It is the designer/engineer/installer's responsibility to review product specifications and technical literature to insure optimal performance and compliance to codes.
- ⑩ Temperature of mixed air entering the heat exchanger is monitored and fresh air intake may be reduced under certain conditions.
- ⑪ BAYACCDOR1A requires BAYFLTR101B & BAYACCDOR2A requires BAYFLTR201B. They are not backward compatible to BAYFLTR101/201A.
- ⑫ When using a BAYACCDOR2A, two 18x20 filters are required.

EXISTING CURB	NEW UNIT 4TCY4/5	USE BAYADAP0**A
BAYCURB030,38A	024-036	50
BAYCURB030,38A	042-060	52
BAYCURB033A	024-036	51
BAYCURB033A	042-060	53
BAYCURB034A	042-060	54

**For dimensional/outline drawings, please refer to Product Data.
 For information on Roof Curbs, please refer to the Accessories/Information Tab.**

For complete equipment / combination selections, installation instructions and warranty information, please refer to Product Data/Ratings and/or Installers Guides and Limited Warranty Handbooks.

BUILT TO A HIGHER STANDARD[®]

American Standard[®]
HEATING & AIR CONDITIONING

Packaged Hybrid/Dual Fuel Convertible 2-5 Tons

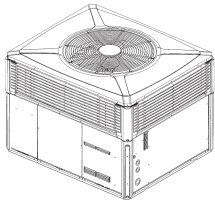
**4DCZ6****Table PK-4-A — 4DCZ6 - Platinum 16 - Convertible Packaged Dual Fuel - R-410A**

Model Number	Cooling Capacity (BTUH)	Gas Capacity Heating Output (1 Stg./2 Stg.)	SEER/EER	HSPF	AFUE(%)	Shipping Weight	MCA	Max Fuse	Sound Rating	Uncrated Dimensions (in.) H x D x W
4DCZ6 – 208-230/1/60										
4DCZ6036C1070A	36,000	45,000/57,000	16.00/12.20	8.30	81.0	488	24.3	35	70	38 x 42 x 49
4DCZ6048C1090A	47,500	58,000/73,000	16.00/12.00	8.50	81.0	665	34.2	50	72	42 x 45 x 59
4DCZ6060C1115A	57,000	75,000/93,000	15.00/11.50	8.30	81.0	676	42.0	60	74	42 x 45 x 59
4DCZ6 – 208-230/3/60										
4DCZ6036B3075A	36,000	48,400/60,000	16.00/12.20	8.30	79.5	488	19.7	30	70	38 x 42 x 49
4DCZ6048B3096A	47,500	62,000/77,000	16.00/12.00	8.50	80.0	665	25.2	35	72	42 x 45 x 59
4DCZ6060B3120A	57,000	77,500/96,000	15.00/11.50	8.30	80.0	676	30.0	45	74	42 x 45 x 59

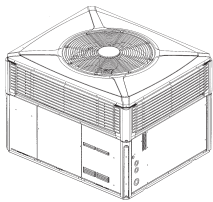
**4DCY4****Table PK-4-B — 4DCY4 - Gold 14 - Convertible Packaged Dual Fuel - R-410A**

Model Number	Cooling Capacity (BTUH)	Gas Capacity Heating Output (1 Stg./2 Stg.)	SEER/EER	HSPF	AFUE(%)	Shipping Weight	MCA	Max Fuse	Sound Rating	Uncrated Dimensions (in.) H x D x W
4DCY4 – 208-230/1/60										
4DCY4024C1060A	23,600	39,000/49,000	14.00/12.00	8.00	81.0	481	16.1	25	68	36 x 42 x 49
4DCY4030C1070A	30,000	45,000/57,000	14.25/12.00	8.00	81.0	481	19.1	30	76	38 x 42 x 49
4DCY4024D1060A	23,600	39,000/49,000	14.00/12.00	8.00	81.0	481	16.1	25	68	36 x 42 x 49
4DCY4030D1070A	30,000	45,000/57,000	14.25/12.00	8.00	81.0	481	19.1	30	76	38 x 42 x 49
4DCY4036C1070A	37,000	45,000/57,000	14.00/12.00	8.00	81.0	488	26.2	40	69	38 x 42 x 49
4DCY4042C1090A	42,000	58,000/73,000	14.00/12.00	8.00	81.0	653	30.8	45	74	38 x 45 x 59
4DCY4048C1090B	47,500	58,000/73,000	14.00/12.00	8.00	81.0	653	35.5	50	73	42 x 45 x 59
4DCY4060C1115A	58,000	75,000/93,000	14.00/12.00	8.00	81.0	676	39.9	60	76	42 x 45 x 59
4DCY4 – 208-230/3/60										
4DCY4036B3075A	36,000	48,400/60,000	14.00/11.40	8.00	79.5	488	19.8	30	69	38 x 42 x 49
4DCY4048A3096C	47,000	62,000/77,000	14.30/10.85	8.00	80.0	653	26.4	40	73	42 x 45 x 59
4DCY4060A3120C	57,500	77,500/96,000	14.00/11.50	8.00	80.0	676	30.6	60	76	42 x 45 x 59

For dimensional/outline drawings, please refer to Product Data.

For information on Roof Curbs, please refer to the Accessories/Information Tab.

For complete equipment / combination selections, installation instructions and warranty information, please refer to Product Data/Ratings and/or Installers Guides and Limited Warranty Handbooks.

Packaged Hybrid/Dual Fuel Convertible 2-5 Tons

	4DCZ6 3-5	4DCY4 2-5
Table PK-5-A — Features		
• SEER up to.....	16.00	14.25
• HSPF up to.....	8.50	8.00
• Exclusive Duration [™] high efficiency compressor with internal overload protection.....	✓	✓
• Factory supplied charge.....	R-410A	R-410A
• Composite Vortica [®] indoor blower.....	✓	✓
• Direct drive, variable speed ECM blower motor **.....	✓	✓
• All aluminum Spine Fin [™] outdoor coil.....	✓	✓
• Swept-blade outdoor fan for quiet operation.....	✓	✓
• Architecturally integrated louvers and corner guards.....	✓	✓
• Polyslate gray cabinet.....	✓	✓
• Stainless steel heat exchanger and burners.....	✓	✓
• Single stage heating & cooling	—	—
• Two stage heating & cooling	✓	—
• 2-stage gas.....	✓	✓
• Start kit - factory installed (single phase only).....	—	2, 2½
• High pressure cutout.....	✓	✓
• Low pressure cutout.....	✓	✓
• Liquid line drier - factory installed.....	✓	✓
• Non-bleed expansion valves on indoor and outdoor coils.....	✓	✓
• Pressure taps, including liquid line taps, easily accessed and protected inside compressor compartment.....	✓	✓
• Right side electrical service access for high and low voltage connections.....	✓	✓
• Rugged steel basepan features deep drawn duct connections.....	✓	✓
• Steeply sloped composite drainpan.....	✓	✓
• Ships in horizontal configuration and converts quickly for downflow.....	✓	✓
• Copper tube, aluminum fin indoor coil.....	✓	✓
• All models are certified to UL 1995.....	✓	✓
• 20-year heat exchanger, 12-year compressor, 10-year coils, & 10-year all other functional parts limited warranty (no registration required; Residential use)	✓	—
• 20-year heat exchanger, 10-year compressor, 10-year coils, & 10-year all other functional parts limited warranty (no registration required; Residential use)	—	✓
• Extended Warranties Available	✓	✓

**Constant airflow ECM (electronically commutated motor).

**For dimensional/outline drawings, please refer to Product Data.
 For information on Roof Curbs, please refer to the Accessories/Information Tab.**

Packaged Hybrid/Dual Fuel Convertible 2-5 Tons

Table PK-6-A — Accessories

Model Number	Description	Shipping Weight	4DCZ6	4DCY4
			3-5	2-5
BAYACCDOR1A	Hinged Filter Access Door [Ⓢ]		3	2-3
BAYACCDOR2A	Hinged Filter Access Door [Ⓢ]		4-5	3½-5
BAYACCEADP1A	Adaptor Kit for Installation of AccuClean™ and 5" Media Filter (Horizontal) [Ⓢ]	10	2-3	2-3
BAYACCEADP2A	Adaptor Kit for Installation of AccuClean™ and 5" Media Filter (Horizontal) [Ⓢ]	12	3½-5	3½-5
BAYADAP050A	Adapter Curb (Cabinet A/B).....		3	2-3
BAYADAP051A	Adapter Curb (Cabinet C).....		3	2-3
BAYADAP052A	Adapter Curb (Cabinet A/B).....		4-5	3½-5
BAYADAP053A	Adapter Curb (Cabinet C).....		4-5	3½-5
BAYADAP054A	Adapter Curb (Cabinet D).....		4-5	3½-5
BAYASCT001	Anti-Short Cycle Timer ^④		✓	✓
BAYCCHT101A	Crankcase Heater (230V) (Reciprocating).....		—	2-2½
BAYCCHT102A	Crankcase Heater (230V) (Scroll).....		4,5	3½-5
BAYCCHT103A	Crankcase Heater (230V) (Scroll).....		3	3
BAYCCHT404B	Crankcase Heater (460V) (Scroll).....		4,5	—
BATCCHT405A	Crankcase Heater (460V) (Scroll).....		3	—
BAYCOVR112A	12" Duct Shroud (Covers Horizontal Ducts) [Ⓢ]		3-5	2-5
BAYCOVR118A	18" Duct Shroud (Covers Horizontal Ducts) [Ⓢ]		3-5	2-5
BAYCURB050A	Flat Roof Full Perimeter Curb (Insulated).....	74	3	2-3
BAYCURB051A	Flat Roof Full Perimeter Curb (Insulated).....	74	4-5	3½-5
BAYDMPR101A	2-Position Motorized Damper ^{②⑦⑧⑨⑩}		3	2-3
BAYDMPR102A	2-Position Motorized Damper ^{②⑦⑧⑨⑩}		4-5	3½-5
BAYECON101A	Economizer with Barometric Relief (Downflow) ^{①②③④⑤⑥}		—	2-3
BAYECON102A	Economizer with Barometric Relief (Downflow) ^{①②③④⑤⑥}		—	3½-5
BAYECON103A	Economizer with Barometric Relief (Downflow) ^{①②③④⑤⑥}	50	3	—
BAYECON104A	Economizer with Barometric Relief (Downflow) ^{①②③④⑤⑥}	65	4-5	—
BAYECON200A	Economizer (Horizontal) ^{①②③④⑦}		—	2-3
BAYECON201A	Economizer (Horizontal) ^{①②③④⑦}		—	3½-5
BAYECON203A	Economizer (Horizontal) ^{①②③④⑦}	85	3	—
BAYECON204A	Economizer (Horizontal) ^{①②③④⑦}	85	4-5	—
BAYENTH001A	Enthalpy Control Kit ^③	2	✓	✓
BAYEXMK001A	Extreme Conditions Mounting Kit.....		✓	✓
BAYEXMK002B	Extreme Conditions Mounting Kit.....		✓	✓
BAYEXMK003A	Extreme Conditions Mounting Kit (Used on Slab Mounts).....		✓	✓
BAYFLTR101C	1-2" Filter Frame ^② -Requires one 18x25 filter (not included).....	6	3	2-3
BAYFLTR201C	1-2" Filter Frame ^{②④} -Requires one 18x20 and one 18x18 (not included).....	6	4-5	3½-5
BAYLIFT002B	Lifting Lug Kit.....	5	✓	✓
BAYLOAM105A	Low Ambient Control Kit.....	5	✓	✓
BAYRLAY004A	Economizer Relay ^①		—	✓
BAYRLAY006A	Economizer Relay ^①	1	✓	—
BAYOSAC001B	Outside Air Control for V.S. Economizer [Ⓢ]		3,4,5	—
BAYOSAH001A	Manual Fresh Air Damper ^②	6	3	2-3
BAYOSAH002A	Manual Fresh Air Damper ^②	8	4-5	3½-5
BAYQSTK300A	Start Kit (not factory installed).....		✓	✓
BAYSQRD001B	16" Round Duct Adapter [Ⓢ]	5	3	2-3
BAYSQRD002B	18" Round Duct Adapter [Ⓢ]	3	4-5	2-5
BAYUTIL101B	Roof Curb Extension Kit.....		3	2-3
BAYUTIL102B	Roof Curb Extension Kit.....		4-5	3½-5

- ① Relay required with economizer on all heat pump applications.
- ② Must use filter frame when economizer/fresh air kit is used.
- ③ Dry bulb control standard with economizer.
- ④ 2-Stage cooling control required when using economizer.
- ⑤ It is the responsibility of the installing dealer to properly size the ductwork for each specific application.
- ⑥ BAYCOVR112,118A will not cover BAYSQRD002B applications.
- ⑦ Does not contain barometric relief.
- ⑧ Max fresh air - 25%.
- ⑨ For non-continuous fan gas-heating applications, the damper opens only when the OD ambient is above 50° F.
- ⑩ It is the designer/engineer/installer's responsibility to review product specifications and technical literature to insure optimal performance and compliance to codes.
- Ⓢ Temperature of mixed air entering the heat exchanger is monitored and fresh air intake may be reduced under certain conditions.
- Ⓣ BAYACCDOR1A requires BAYFLTR101B & BAYACCDOR2A requires BAYFLTR201B. They are not backward compatible to BAYFLTR101/201A.
- Ⓤ BAYOSAC001B is not compatible with BAYACCDOR1A or BAYACCDOR2A.
- Ⓧ When using a BAYACCDOR2A, two 18x20 filters are required.

EXISTING CURB	NEW UNIT 4WC/DC**A	USE BAYADAP0**A
BAYCURB030,38A	024-036	50
BAYCURB030,38A	042-060	52
BAYCURB033A	024-036	51
BAYCURB033A	042-060	53
BAYCURB034A	042-060	54

**For dimensional/outline drawings, please refer to Product Data.
 For information on Roof Curbs, please refer to the Accessories/Information Tab.**

For complete equipment / combination selections, installation instructions and warranty information, please refer to Product Data/Ratings and/or Installers Guides and Limited Warranty Handbooks.

BUILT TO A HIGHER STANDARD™

American Standard
HEATING & AIR CONDITIONING

Packaged Heat Pump Convertible 2-5 Tons

Packaged Heat Pump

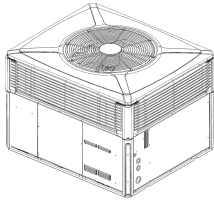

4WCZ6

Table PK-7-A — 4WCZ6 - Platinum 16 - Convertible Packaged Heat Pump - R-410A

Model Number	Capacity	SEER	EER High/Low	HSPF	Shipping Weight	MCA	Max Fuse	Sound Rating	Uncrated Dimensions (in.) H x D x W
4WCZ6 – 208-230/1/60									
4WCZ6024A1000A	24,000	16.00	12.00/18.30	8.20	442	19.5	30	67	38 x 42 x 49
4WCZ6036B1000A	36,000	16.00	12.20/17.45	8.30	468	24.3	35	70	38 x 42 x 49
4WCZ6048B1000A	47,500	16.00	12.00/17.50	8.50	607	34.2	50	72	42 x 45 x 59
4WCZ6060B1000A	57,000	15.00	11.50/15.90	8.30	623	42.0	60	74	42 x 45 x 59
4WCZ6 – 208-230/3/60									
4WCZ6036B3000A	36,000	16.00	12.20/17.45	8.30	468	19.7	30	70	38 x 42 x 49
4WCZ6048B3000A	47,500	16.00	12.00/17.50	8.50	607	25.2	35	72	42 x 45 x 59
4WCZ6060B3000A	57,000	15.00	11.50/15.90	8.30	623	30.0	45	74	42 x 45 x 59
4WCZ6 – 460/3/60									
4WCZ6036B4000A	36,000	16.00	12.20/17.45	8.30	468	11.9	15	70	38 x 42 x 49
4WCZ6048B4000A	47,500	16.00	12.00/17.50	8.50	607	15.3	20	72	42 x 45 x 59
4WCZ6060B4000A	57,000	15.00	11.50/15.90	8.30	623	17.0	20	74	42 x 45 x 59

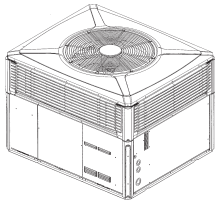

4WCY5

Table PK-7-B — 4WCY5 - Gold 15 - Convertible Packaged Heat Pump - R-410A

Model Number	Capacity	SEER/EER	HSPF	Shipping Weight	MCA	Max Fuse	Sound Rating	Uncrated Dimensions (in.) H x D x W
4WCY5 – 208-230/1/60								
4WCY5024A1000A	25,000	15.00/13.00	8.30	453	18.1	25	69.1	36 x 42 x 49
4WCY5030A1000A	30,000	15.00/12.00	8.20	430	22.8	35	70.0	38 x 42 x 49
4WCY5036A1000A	36,000	15.00/12.00	8.40	439	24.7	40	69.4	38 x 42 x 49
4WCY5042A1000A	41,500	15.00/12.00	8.40	607	28.6	45	72.0	38 x 45 x 59
4WCY5048A1000A	47,500	15.00/12.00	8.40	607	34.2	50	72.0	42 x 45 x 59
4WCY5060A1000A	57,500	15.00/11.50	8.40	623	42.2	60	74.0	42 x 45 x 59

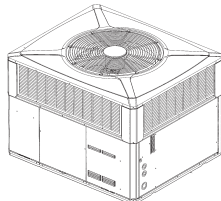

4WCC4

Table PK-7-C — 4WCC4 - Silver 14 - Convertible Packaged Heat Pump - R-410A

Model Number	Capacity	SEER/EER	HSPF	Shipping Weight	MCA	Max Fuse	Sound Rating	Uncrated Dimensions (in.) H x D x W
4WCC4 – 208-230/1/60								
4WCC4024A1000A	24,600	14.00/12.00	8.00	402	19.1	30	66	36 x 42 x 49
4WCC4030A1000A	30,400	14.00/12.00	8.00	430	22.6	35	69	38 x 42 x 49
4WCC4036A1000A	35,800	14.00/12.00	8.00	439	24.4	40	69	38 x 42 x 49
4WCC4042A1000A	43,000	14.00/12.00	8.00	548	28.4	45	71	40 x 45 x 59
4WCC4048A1000A	48,000	14.00/12.00	8.00	529	31.1	50	72	40 x 45 x 59
4WCC4060A1000A	58,000	14.00/12.00	8.00	594	39.1	60	77	42 x 45 x 59

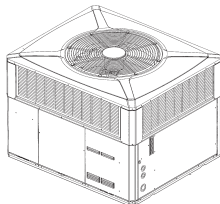

**4WCY4
(3-phase only)**

Table PK-7-D — 4WCY4 - Gold 14 - Convertible Packaged Heat Pump - R-410A

Model Number	Capacity	SEER/EER	HSPF	Shipping Weight	MCA	Max Fuse	Sound Rating	Uncrated Dimensions (in.) H x D x W
4WCY4 – 208-230/3/60								
4WCY4036B3000A	36,000	14.00/11.70	8.00	468	18.4	25	69	38 x 42 x 49
4WCY4048A3000C	47,000	14.00/11.75	8.00	607	25.3	35	73	38 x 45 x 59
4WCY4060A3000C	58,000	14.00/11.50	8.00	623	28.6	45	76	42 x 45 x 59

For dimensional/outline drawings, please refer to Product Data.

For information on Roof Curbs, please refer to the Accessories/Information Tab.

For complete equipment / combination selections, installation instructions and warranty information, please refer to Product Data/Ratings and/or Installers Guides and Limited Warranty Handbooks.

BUILT TO A HIGHER STANDARD[®]

American Standard[®]
HEATING & AIR CONDITIONING

Packaged Heat Pump Convertible 2-5 Tons

Table PK-8-A — Features	4WCZ6 2-5	4WCY5 2-5	4WCY4 3-5	4WCC4 2-5
• SEER up to.....	16.00	15.00	14.25	14.00
• HSPF up to.....	8.50	8.20	8.00	8.00
• Exclusive Duration™ high efficiency compressor with internal overload protection.....	✓	✓	✓	—
• Factory supplied charge.....	R-410A	R-410A	R-410A	R-410A
• Composite Vortica® indoor blower.....	✓	✓	✓	✓
• Direct drive, multi-speed ECM blower motor (high efficiency)*.....	—	—	—	✓
• Direct drive, variable speed ECM blower motor **.....	✓	✓	✓	—
• All aluminum Spine Fin™ outdoor coil.....	✓	✓	✓	✓
• Swept-blade outdoor fan for quiet operation.....	✓	✓	✓	—
• Architecturally integrated louvers and corner guards.....	✓	✓	✓	—
• Polyslate gray cabinet.....	✓	✓	✓	✓
• Single stage heating & cooling	—	2 - 3½	✓	✓
• Two stage heating & cooling	✓	4, 5	—	—
• Start kit - factory installed (single phase only).....	—	2, 2½	—	—
• High pressure cutout.....	✓	✓	✓	✓
• Low pressure cutout.....	✓	✓	✓	✓
• Liquid line drier - factory installed.....	✓	✓	✓	✓
• Non-bleed expansion valves on indoor and outdoor coils.....	✓	✓	✓	✓
• Pressure taps, including liquid line taps, easily accessed and protected inside compressor compartment.....	✓	✓	✓	✓
• Right side electrical service access for high and low voltage connections.....	✓	✓	✓	✓
• Rugged steel basepan features deep drawn duct connections.....	✓	✓	✓	✓
• Steeply sloped composite drainpan.....	✓	✓	✓	✓
• Ships in horizontal configuration and converts quickly for downflow.....	✓	✓	✓	✓
• Copper tube, aluminum fin indoor coil.....	✓	✓	✓	✓
• All models are certified to UL 1995.....	✓	✓	✓	✓
• 10-year compressor, 10-year outdoor coil, & 10-year all other functional parts limited warranty (no registration required; Residential use)	—	✓	✓	✓
• 12-year compressor, 10-year outdoor coil, & 10-year all other functional parts limited warranty (no registration required; Residential use)	✓	—	—	—
• Extended Warranties Available	✓	✓	✓	✓

*Constant torque ECM (electronically commutated motor).
**Constant airflow ECM (electronically commutated motor).

**For dimensional/outline drawings, please refer to Product Data.
For information on Roof Curbs, please refer to the Accessories/Information Tab.**

For complete equipment / combination selections, installation instructions and warranty information, please refer to Product Data/Ratings and/or Installers Guides and Limited Warranty Handbooks.

Packaged Heat Pump Convertible 2-5 Tons

Table PK-9-A — Accessories

Model Number	Description	Shipping Weight	4WCZ6	4WCY5	4WCY4	4WCC4
			2-5	2-5	3-5	2-5
BAYACCDOR1A	Hinged Filter Access Door [Ⓜ]		2-3	2-3	3	2-3
BAYACCDOR2A	Hinged Filter Access Door [Ⓜ]		4-5	3½-5	3½-5	3½-5
BAYACCEADP1A	Adaptor Kit for Installation of AccuClean™ and 5" Media Filter (Horizontal) [Ⓜ] 10.....	10	2-3	2-3	3	2-3
BAYACCEADP2A	Adaptor Kit for Installation of AccuClean™ and 5" Media Filter (Horizontal) [Ⓜ] 12.....	12	3½-5	3½-5	3½-5	3½-5
BAYADAP050A	Adapter Curb (Cabinet A/B).....		2-3	2-3	3	2-3
BAYADAP051A	Adapter Curb (Cabinet C).....		2-3	2-3	3	2-3
BAYADAP052A	Adapter Curb (Cabinet A/B).....		4-5	3½-5	3½-5	3½-5
BAYADAP053A	Adapter Curb (Cabinet C).....		4-5	3½-5	3½-5	3½-5
BAYADAP054A	Adapter Curb (Cabinet D).....		4-5	3½-5	3½-5	3½-5
BAYASCT001	Anti-Short Cycle Timer [Ⓞ]		✓	✓	✓	✓
BAYCCHT102A	Crankcase Heater (230V) (Scroll).....		4,5	3½-5	3½-5	3½-5
BAYCCHT103A	Crankcase Heater (230V) (Scroll).....		2-3	2-3	3	2-3
BAYCCHT404B	Crankcase Heater (460V) (Scroll).....		4, 5	—	—	—
BAYCCHT405A	Crankcase Heater (460V) (Scroll).....		3	—	—	—
BAYCOVR112A	12" Duct Shroud (Covers Horizontal Ducts) [Ⓞ]		2-5	2-5	3-5	2-5
BAYCOVR118A	18" Duct Shroud (Covers Horizontal Ducts) [Ⓞ]		2-5	2-5	3-5	2-5
BAYCURB050A	Flat Roof Full Perimeter Curb (Insulated).....	.74	2-3	2-3	3	2-3
BAYCURB051A	Flat Roof Full Perimeter Curb (Insulated).....	.74	3-5	3½-5	3½-5	3½-5
BAYDMPR101A	2-Position Motorized Damper [Ⓜ] [Ⓞ] [Ⓞ] [Ⓞ] [Ⓞ]		2-3	2-3	3	2-3
BAYDMPR102A	2-Position Motorized Damper [Ⓜ] [Ⓞ] [Ⓞ] [Ⓞ] [Ⓞ]		4-5	3½-5	3½-5	3½-5
BAYECON101A	Economizer with Barometric Relief (Downflow) [Ⓜ] [Ⓞ] [Ⓞ] [Ⓞ] [Ⓞ] [Ⓞ]		—	2-3	2-3	2-3
BAYECON102A	Economizer with Barometric Relief (Downflow) [Ⓜ] [Ⓞ] [Ⓞ] [Ⓞ] [Ⓞ] [Ⓞ]		—	3½-5	3½-5	3½-5
BAYECON103A	Economizer with Barometric Relief (Downflow) [Ⓜ] [Ⓞ] [Ⓞ] [Ⓞ] [Ⓞ] [Ⓞ] 50.....	50	2-3	—	—	—
BAYECON104A	Economizer with Barometric Relief (Downflow) [Ⓜ] [Ⓞ] [Ⓞ] [Ⓞ] [Ⓞ] [Ⓞ] 65.....	65	4-5	—	—	—
BAYECON200A	Economizer (Horizontal) [Ⓜ] [Ⓞ] [Ⓞ] [Ⓞ] [Ⓞ] [Ⓞ]		—	2-3	3	2-3
BAYECON201A	Economizer (Horizontal) [Ⓜ] [Ⓞ] [Ⓞ] [Ⓞ] [Ⓞ] [Ⓞ]		—	3½-5	3½-5	3½-5
BAYENTH001A	Enthalpy Control Kit [Ⓞ]	2	✓	✓	✓	✓
BAYEXMK001A	Extreme Conditions Mounting Kit.....		✓	✓	✓	✓
BAYEXMK002B	Extreme Conditions Mounting Kit.....		✓	✓	✓	✓
BAYEXMK003A	Extreme Conditions Mounting Kit (Used on Slab Mounts).....		✓	✓	✓	✓
BAYFLTR101C	1-2" Filter Frame [Ⓜ] -Requires one 18x25 filter (not included)..... 6.....	6	2-3	2-3	2-3	2-3
BAYFLTR201C	1-2" Filter Frame [Ⓜ] [Ⓞ] -Requires one 18x20, and one 18x18 filters (not included)..... 6.....	6	4-5	3½-5	3½-5	3½-5
BAYLIFT002B	Lifting Lug Kit.....	5	✓	✓	✓	✓
BAYLOAM105A	Low Ambient Control Kit.....	5	✓	✓	✓	✓
BAYRLAY004A	Economizer Relay [Ⓞ]	1	—	✓	✓	✓
BAYRLAY006A	Economizer Relay [Ⓞ]	1	—	—	—	—
BAYOSAC001B	Outside Air Control for V.S. Economizer [Ⓞ]		2,4,5	—	—	3-5
BAYOSAH001A	Manual Fresh Air Damper [Ⓞ]	6	2-3	2-3	3	2-3
BAYOSAH002A	Manual Fresh Air Damper [Ⓞ]	8	4,5	3½-5	3½-5	3½-5
BAYQSTK300A	Start Kit (not factory installed).....		✓	✓	✓	✓
BAYSQRD001B	16" Round Duct Adapter [Ⓞ]	5	2-3	2-3	2-3	2-3
BAYSQRD002B	18" Round Duct Adapter [Ⓞ]	3	4-5	2-5	2-5	2-5
BAYUTIL101B	Roof Curb Extension Kit.....		2-3	2-3	2-3	2-3
BAYUTIL102B	Roof Curb Extension Kit.....		4,5	3½-5	3½-5	3½-5

- ① Relay required with economizer on all heat pump applications.
- ② Must use filter frame when economizer/fresh air kit is used.
- ③ Dry bulb control standard with economizer.
- ④ 2-Stage cooling control required when using economizer.
- ⑤ It is the responsibility of the installing dealer to properly size the ductwork for each specific application.
- ⑥ BAYCOVR112,118A will not cover BAYSQRD002B applications.
- ⑦ Does not contain barometric relief.
- ⑧ Max fresh air - 25%.
- ⑨ For non-continuous fan gas-heating applications, the damper opens only when the OD ambient is above 50° F.
- ⑩ It is the designer/engineer/installer's responsibility to review product specifications and technical literature to insure optimal performance and compliance to codes.
- ⑪ Temperature of mixed air entering the heat exchanger is monitored and fresh air intake may be reduced under certain conditions.
- ⑫ BAYACCDOR1A requires BAYFLTR101B & BAYACCDOR2A requires BAYFLTR201B. They are not backward compatible to BAYFLTR101/201A.
- ⑬ BAYOSAC001B is not compatible with BAYACCDOR1A or BAYACCDOR2A.
- ⑭ When using a BAYACCDOR2A, two 18x20 filters are required.

EXISTING CURB	NEW UNIT 4WCY*A	USE BAYADAP0**A
BAYCURB030,38A	024-036	50
BAYCURB030,38A	042-060	52
BAYCURB033A	024-036	51
BAYCURB033A	042-060	53
BAYCURB034A	042-060	54

**For dimensional/outline drawings, please refer to Product Data.
 For information on Roof Curbs, please refer to the Accessories/Information Tab.**

For complete equipment / combination selections, installation instructions and warranty information, please refer to Product Data/Ratings and/or Installers Guides and Limited Warranty Handbooks.

BUILT TO A HIGHER STANDARD[®]

American Standard[®]
HEATING & AIR CONDITIONING

Packaged Heat Pump Over/Under 2-3½ Tons

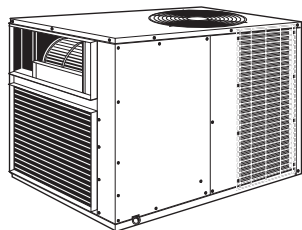

4WHC4

- Duration[®] compressor
- Over (supply) under (return) air
- Compressor internal overload protection
- Solenoid operated switchover valve
- Demand defrost control system
- Multi-speed direct drive blower motor
- High efficiency multi-speed ECM indoor motor on 4WHC4024-4036. 4WHC4042 models are variable speed.
- Weather resistant Powder Paint
- Copper tube, aluminum plate fin coils
- Top discharge condensing fan
- Factory installed wrap-around coil guard
- Top access to supplementary heater
- Pressure taps for refrigerant checks
- Polarized plug for easy field connection of low voltage to supplementary heaters
- Low ambient cooling to 55°F as manufactured
- Low ambient cooling to 0°F with accessory BAYLOAM011A
- All models are certified to UL 1995
- **10-year registered limited warranty on compressor, outdoor coil and all other functional parts (Residential Use)**
- **Optional extended warranties**

Table PK-10-A — Silver 14 – Over/Under Horizontal Unit – R-410A

Model No.	Capacity	SEER/EER	HSPF	Uncrated Dimensions(in.) H X D X W	Weight (lbs.)	MCA*	Max Fuse*	Sound Rating	
4WHC4024A1000B	24,800	16/13.6	8.2	31 x 44 x 32	322	18.7	25	74	
4WHC4030A1000B	30,000	14/12	8	31 x 44 x 32	322	21.1	30	74	
4WHC4036A1000B	35,800	14/12	8	31 x 44 x 32	322	26.2	40	75	
4WHC4042A1000B	39,500	14/12	8	31 x 44 x 32	353	30.5	45	75	
Tons	Supply H x W	Return H x W							
2 – 3½	8¾ x 27¾	16¾ x 27¾							

Dimensions are in inches. See Outline Dimensions.

* Information subject to change. Please confirm with current Product Data/Service Facts for current factory production.

Compressor Types are: R1 = Reciprocating One Cylinder, R2 = Reciprocating Two Cylinder, S = Scroll

Table PK-10-B— Supplementary Heaters – Heater Matrix

Model No.①	Power Supply	kW Ratings	Used With	Shipping Weight
BAYHTRC106A	208/240/1/60	4.33/5.76 kW	4WHC4024-42	9
BAYHTRC109A	208/240/1/60	6.12/8.16 kW	4WHC4036-42	10
BAYHTRC111A	208/240/1/60	7.98/10.56 kW	4WHC4024-42	10
BAYHTRC117A	208/240/1/60	12.98/17.28 kW	4WHC4030-42	23

Table PK-10-C — Accessories/Comfort Controls

Model No.	Description	Used With	Shipping Weight
BAYASCT001②③	Anti-Short Cycle Timer	All 4WHC4 Models	1
BAYECMT003A	Extreme Conditions Mounting Kit (Slab or Rack Mount)	All 4WHC4 Models	2
BAYLOAM011A	Low Ambient Cooling Kit	All 4WHC4 Models	5
TAYASCT501A③	5 Minute Delay Relay	All 4WHC4 Models	2
TCONT402A	3Heat/2Clg (Heat Pump/A/C)	All 4WHC4 Models	1
TCONT602A	2Heat/2Clg (Heat Pump/A/C)	All 4WHC4 Models	1
TCONT802A	3Heat/2Clg (Heat Pump/A/C)	All 4WHC4 Models	1
TCONT803A	3Heat/2Clg (Heat Pump/A/C) w/Humidity Display	All 4WHC4 Models	1

① Heaters must have an "A" in eleventh digit to work on 4WHC4 models.

② Not for use with electronic thermostats.

③ Activated on Power Off.

**For dimensional/outline drawings, please refer to Product Data.
For information on Roof Curbs, please refer to the Accessories/Information Tab.**

For complete equipment / combination selections, installation instructions and warranty information, please refer to Product Data/Ratings and/or Installers Guides and Limited Warranty Handbooks.

Packaged Gas/Electric Convertible 2-5 Tons

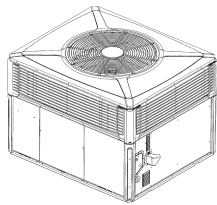

4YCZ6

Table PK-11-A — 4YCZ6 - Platinum 16 - Convertible Packaged Gas/Electric - R-410A

Model Number	Cooling Capacity (BTUH)	Heating Capacity Output (1 Stg./2 Stg.)	SEER	EER High/Low	AFUE(%)	Shipping Weight	MCA	Max Fuse	Sound Rating	Uncrated Dimensions (in.) H x D x W
4YCZ6 – 208-230/1/60										
4YCZ6024A1060A	24,000	38,800/48,600	16.00	12.00/17.60	81.0	440	19.5	30	65	36 x 42 x 49
4YCZ6036C1070A	35,600	45,000/57,000	16.60	12.00/13.60	81.0	488	24.2	35	70	38 x 42 x 49
4YCZ6036C1090A	35,600	58,000/73,000	16.60	12.00/13.60	81.0	488	24.2	35	70	38 x 42 x 49
4YCZ6048C1090A	48,000	58,000/73,000	16.00	12.00/13.48	81.0	659	34.1	50	71	42 x 45 x 59
4YCZ6048C1115A	48,000	75,000/93,000	16.00	12.00/13.48	81.0	665	34.1	50	71	42 x 45 x 59
4YCZ6060C1115A	57,500	75,000/93,000	15.10	11.40/12.64	81.0	676	44.4	60	73	42 x 45 x 59
4YCZ6 – 208-230/3/60										
4YCZ6036A3075C	35,600	45,000/60,000	16.60	12.00/13.60	80.0	488	19.7	30	70	38 x 42 x 49
4YCZ6036A3096C	35,600	57,600/77,000	16.60	12.00/13.60	80.0	493	19.7	30	70	38 x 42 x 49
4YCZ6048A3096C	48,000	57,600/77,000	16.00	12.00/13.48	80.0	659	25.2	35	71	42 x 45 x 59
4YCZ6048A3120C	48,000	72,000/96,000	16.00	12.00/13.48	80.0	665	25.2	35	71	42 x 45 x 59
4YCZ6060A3120C	57,500	72,000/96,000	15.10	11.40/12.65	80.0	676	28.6	40	73	42 x 45 x 59
4YCZ6 – 460/3/60										
4YCZ6036A4075D	35,600	45,000/60,000	16.60	12.00/13.60	79.0	488	11.9	15	70	38 x 42 x 49
4YCZ6036A4096D	35,600	57,600/77,000	16.60	12.00/13.60	80.0	493	11.9	15	70	38 x 42 x 49
4YCZ6048A4096D	48,000	57,600/77,000	16.00	12.00/13.48	80.0	659	15.3	20	71	42 x 45 x 59
4YCZ6048A4120D	48,000	72,000/96,000	16.00	12.00/13.48	80.0	665	15.3	20	71	42 x 45 x 59
4YCZ6060A4120D	57,500	72,000/96,000	15.10	11.40/12.65	80.0	676	17.2	20	73	42 x 45 x 59

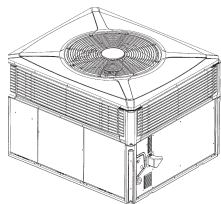

4ICY5

Table PK-11-B — 4ICY5- Gold 15 - Convertible Packaged Gas/Electric - R-410A

Model Number	Cooling Capacity (BTUH)	Heating Capacity Output (1 Stg./2 Stg.)	SEER/EER	AFUE(%)	Shipping Weight	MCA	Max Fuse	Sound Rating	Uncrated Dimensions (in.) H x D x W
4ICY5 – 208-230/1/60									
4ICY5024A1060A	23,800	48,000/60,000	15.00/12.00	81	425	18.4	25	65	36 x 42 x 49
4ICY5030A1070A	28,400	56,000/70,000	15.00/12.00	81	455	21.2	30	70	36 x 42 x 49
4ICY5036A1070A	36,000	56,000/70,000	15.00/12.00	81	460	23.8	35	69	38 x 42 x 49
4ICY5036A1090A	36,000	72,000/90,000	15.00/12.00	81	465	23.8	35	69	38 x 42 x 49
4ICY5042A1090A	41,000	72,000/90,000	15.00/12.00	81	593	28.6	45	71	38 x 45 x 59
4ICY5048A1090A	48,000	72,000/90,000	15.00/12.00	81	616	34.2	50	71	38 x 45 x 59
4ICY5048A1115A	48,000	90,000/115,000	15.00/12.00	81	622	34.2	50	71	38 x 45 x 59
4ICY5060A1115A	57,500	92,000/115,000	15.00/11.40	81	633	44.4	60	73	42 x 45 x 59

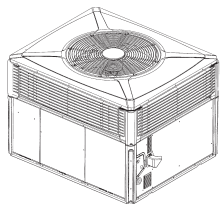

**4ICY4
 (3-phase only)**

Table PK-11-C — 4ICY4 - Gold 14 - Convertible Packaged Gas/Electric - R-410A

Model Number	Cooling Capacity (BTUH)	Heating Capacity Output (1 Stg./2 Stg.)	SEER/EER	AFUE(%)	Shipping Weight	MCA	Max Fuse	Sound Rating	Uncrated Dimensions (in.) H x D x W
4ICY4 – 208-230/3/60									
4ICY4036B3075A	38,000	45,000/60,000	14.30/12.00	80.0	488	18.5	25	69	38 x 42 x 49
4ICY4036B3096A	38,000	57,600/77,000	14.20/12.00	80.0	493	18.5	25	69	38 x 42 x 49
4ICY4048B3096A	48,000	57,600/77,000	14.20/12.00	80.0	653	25.3	35	73	38 x 45 x 59
4ICY4048B3120A	48,000	72,000/96,000	14.20/11.90	80.0	659	25.3	35	73	38 x 45 x 59
4ICY4060A3120B	58,500	72,000/96,000	14.30/12.00	80.0	676	28.6	40	76	42 x 45 x 59

**For dimensional/outline drawings, please refer to Product Data.
 For information on Roof Curbs, please refer to the Accessories/Information Tab.**

For complete equipment / combination selections, installation instructions and warranty information, please refer to Product Data/Ratings and/or Installers Guides and Limited Warranty Handbooks.

BUILT TO A HIGHER STANDARD[®]

American Standard[®]
HEATING & AIR CONDITIONING

Packaged Gas/Electric Convertible 2-5 Tons

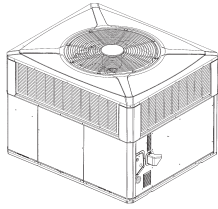

4YCC4

Table PK-12-A — 4YCC4 - Silver 14 - Convertible Packaged Gas/Electric - R-410A

Model Number	Cooling Capacity (BTUH)	Heating Capacity Input/Output	SEER/EER	AFUE(%)	Shipping Weight	MCA	Max Fuse	Sound Rating	Cabinet Dimensions (in.) H x D x W
4YCC4 – 208-230/1/60									
4YCC4024A1060A	24,600	60,000/49,000	14.00/12.00	81.0	481	19.1	30	67	36 x 42 x 49
4YCC4030A1070A	28,200	70,000/57,000	14.00/12.00	81.0	481	22.6	35	69	36 x 42 x 49
4YCC4036A1070A	37,000	70,000/57,000	14.00/12.00	81.0	488	24.5	40	69	38 x 42 x 49
4YCC4036A1090A	37,000	90,000/73,000	14.00/12.00	81.0	493	24.5	40	69	38 x 42 x 49
4YCC4042A1060A	40,500	60,000/49,000	14.00/12.00	81.0	653	28.5	45	75	36 x 45 x 59
4YCC4042A1090A	40,500	90,000/73,000	14.00/12.00	81.0	653	28.5	45	75	36 x 45 x 59
4YCC4048A1070A	46,500	70,000/57,000	14.00/11.50	81.0	645	32.0	50	73	40 x 45 x 59
4YCC4048A1090A	46,500	90,000/73,000	14.00/11.50	81.0	653	32.0	50	73	40 x 45 x 59
4YCC4060A1090A	58,000	90,000/73,000	14.00/11.50	81.0	678	39.1	60	73	40 x 45 x 59
4YCC4060A1115A	58,000	115,000/93,000	14.00/11.50	81.0	684	39.1	60	73	40 x 45 x 59

For dimensional/outline drawings, please refer to Product Data.

For information on Roof Curbs, please refer to the Accessories/Information Tab.

For complete equipment / combination selections, installation instructions and warranty information, please refer to Product Data/Ratings and/or Installers Guides and Limited Warranty Handbooks.

Packaged Gas/Electric Convertible 2-5 Tons

Table PK-13-A — Features

	4YCZ6 2-5	4YCY5 2-5	4YCY4 2-5	4YCC4 2-5
• SEER up to	16.60	15.00	14.25	14.00
• Exclusive Duration™ high efficiency compressor with internal overload protection	✓	✓	✓	✓
• Factory supplied charge	R-410A	R-410A	R-410A	R-410A
• Composite Vortica® indoor blower	✓	✓	✓	✓
• High efficiency ECM indoor blower motor with Comfort-R™ airflow system	✓	✓	✓	—
• Direct drive, multi-speed ECM blower motor (high efficiency)*	—	—	—	✓
• All aluminum Spine Fin™ outdoor coil	✓	✓	✓	✓
• Swept-blade outdoor fan for quiet operation	✓	✓	✓	✓
• Architecturally integrated louvers and corner guards	✓	✓	✓	✓
• Polyslate gray cabinet	✓	✓	✓	✓
• Stainless steel heat exchanger and burners	✓	✓	✓	✓
• Single stage cool	—	2-3½	✓	✓
• Single stage gas	—	—	—	✓
• 2-stage cooling	✓	4, 5	—	✓
• 2-stage gas	✓	✓	✓	✓
• Start kit - factory installed (single phase only)	—	—	—	✓
• High pressure cutout	✓	✓	✓	✓
• Low pressure cutout	✓	✓	✓	✓
• Liquid line drier - factory installed	✓	✓	✓	✓
• Non-bleed expansion valves on indoor coil	✓	✓	✓	✓
• Pressure taps, including liquid line taps, easily accessed and protected inside compressor compartment	✓	✓	✓	✓
• Right side electrical service access for high and low voltage connections	✓	✓	✓	✓
• Rugged steel basepan features deep drawn duct connections	✓	✓	✓	✓
• Steeply sloped composite drainpan	✓	✓	✓	5
• Ships in horizontal configuration and converts quickly for downflow	✓	✓	✓	2-4
• Copper tube, aluminum fin indoor coil	3, 4, 5	3, 4, 5	✓	5
• All aluminum indoor coil	2	2, 2½, 3½	—	2-4
• All models are certified to ANSI 221.47/CSA 2.3	✓	✓	✓	—
• 20-year heat exchanger, 12-year compressor, 10-year coils, & 10-year all other functional parts limited warranty (no registration required; Residential use)	✓	—	—	—
• 20-year heat exchanger, 10-year compressor, 10-year coils, & 10-year all other functional parts limited warranty (no registration required; Residential use)	—	✓	✓	✓
• Extended warranties available	✓	✓	✓	✓

*Constant torque ECM (electronically commutated motor).

**For dimensional/outline drawings, please refer to Product Data.
 For information on Roof Curbs, please refer to the Accessories/Information Tab.**

BUILT TO A HIGHER STANDARD™

American Standard®
HEATING & AIR CONDITIONING

Packaged Gas/Electric Convertible 2-5 Tons

Table PK-14-A — Accessories

Model Number	Description	Shipping Weight	4YCY6 2-5	4YCY5 2-5	4YCY4 3-5	4YCC4 2-5
BAYACCDOR1A	Hinged Filter Access Door ^②		2-3	2-3	2-3	2-3
BAYACCDOR2A	Hinged Filter Access Door ^②		3½-5	3½-5	3½-5	3½-5
BAYACCEADP1A	Adaptor Kit for Installation of AccuClean™ and 5" Media Filter (Horizontal) ^⑩	10	2-3	2-3	3	2-3
BAYCURB051A	Adaptor Kit for Installation of AccuClean™ and 5" Media Filter (Horizontal) ^⑩	12	3½-5	3½-5	3½-5	3½-5
BAYADAP050A	Adapter Curb (Cabinet A/B)		2-3	2-3	2-3	2-3
BAYADAP051A	Adapter Curb (Cabinet C)		2-3	2-3	2-3	2-3
BAYADAP052A	Adapter Curb (Cabinet A/B)		4-5	3½-5	3½-5	3½-5
BAYADAP053A	Adapter Curb (Cabinet C)		4-5	3½-5	3½-5	3½-5
BAYADAP054A	Adapter Curb (Cabinet D)		4-5	3½-5	3½-5	3½-5
BAYASCT001	Anti-Short Cycle Timer ^③		✓	—	✓	✓
BAYCCHT102A	Crankcase Heater (230v) (Scroll)			3½-5		3½-5
BAYCCHT103A	Crankcase Heater (230V) (Scroll)		2-3	2-3	3	2-3
BAYCCHT404B	Crankcase Heater (460v) (Scroll)		4-5	—	—	—
BAYCCHT405A	Crankcase Heater (460v) (Scroll)		3	—	—	—
BAYCOVR112A	12" Duct Shroud (Covers Horizontal Ducts) ^⑤		2-5	2-5	2-5	2-5
BAYCOVR118A	18" Duct Shroud (Covers Horizontal Ducts) ^⑤		2-5	2-5	2-5	2-5
BAYCURB050A	Flat Roof Full Perimeter Curb (Insulated)	74	3	2-3	2-3	2-3
BAYCURB051A	Flat Roof Full Perimeter Curb (Insulated)	74	4-5	3½-5	3½-5	3½-5
BAYDMPR101A	Motorized Fresh Air Damper ^{①⑦⑧⑨⑩}		2-3	2-3	2-3	2-3
BAYDMPR102A	Motorized Fresh Air Damper ^{①⑦⑧⑨⑩}		4-5	3½-5	3½-5	3½-5
BAYECON101A	Economizer with Barometric Relief (Downflow) ^{①②③⑩⑪}	50	—	2-3	2-3	2-3
BAYECON102A	Economizer with Barometric Relief (Downflow) ^{①②③⑩⑪}	65	—	3½	3½-5	½-5
BAYECON103A	Economizer with Barometric Relief (Downflow) ^{①②③⑩⑪}		2-3	—	—	—
BAYECON104A	Economizer with Barometric Relief (Downflow) ^{①②③⑩⑪}		4-5	4-5	—	—
BAYECON200A	Economizer (Horizontal) ^{①②③⑦}	85	—	2-3	2-3	2-3
BAYECON201A	Economizer (Horizontal) ^{①②③⑦}	85	—	3½	3½-5	3½-5
BAYECON203A	Economizer (Horizontal) ^{①②③⑦}		2-3	—	—	—
BAYECON204A	Economizer (Horizontal) ^{①②③⑦}		4-5	4-5	—	—
BAYENTH001A	Enthalpy Control Kit ^②	2	✓	✓	✓	✓
BAYEXMK001A	Extreme Conditions Mounting Kit (Used on BAYCURB & BAYADAP)		✓	✓	✓	✓
BAYEXMK002B	Extreme Conditions Mounting Kit (Used on BAYUTIL)		✓	✓	✓	✓
BAYEXMK003A	Extreme Conditions Mounting Kit (Used on Slab Mounts)		✓	✓	✓	✓
BAYFLTR101C	1-2" Filter Frame ^① -Requires one 18x25 filter (not included)	6	2-3	2-3	2-3	2-3
BAYFLTR201C	1-2" Filter Frame ^{①⑭} -Requires one 18x20, and one 18x18 filter (not inc)	6	4-5	3½-5	3½-5	3½-5
BAYLIFT002B	Lifting Lug Kit	5	✓	✓	✓	✓
BAYLOAM105A	Low Ambient Control Kit	5	✓	✓	✓	✓
BAYLPKT100A	LP Conversion Kit		115K	115K	115K	115K
BAYLPKT101A	LP Conversion Kit		60K,90K	60K, 90K	60K,90K	60K, 90K
BAYLPKT102A	LP Conversion Kit		70K	70K	70K	70K
BAYOSAC001B	Outside Air Control for V.S. Economizer ^③		3,4,5	4-5	—	—
BAYOSAH001A	Manual Fresh Air Damper ^①	6	2-3	2-3	2-3	2-3
BAYOSAH002A	Manual Fresh Air Damper ^①	8	4-5	3½-5	3½-5	3½-5
BAYQSTK301A	Start Kit (not factory installed)		✓	✓	—	✓
BAYSQRD001B	16" Round Duct Adapter ^⑤	5	2-3	2-3	2-3	2-3
BAYSQRD002B	18" Round Duct Adapter ^⑤	3	4-5	2-5	2-5	2-5
BAYUTIL101B	Roof Curb Utility Extension Kit		2-3	2-3	2-3	2-3
BAYUTIL102B	Roof Curb Utility Extension Kit		4-5	3½-5	3½-5	3½-5

- ① Must use filter frame when economizer/fresh air kit is used.
- ② Dry bulb control standard with economizer.
- ③ 2-Stage cooling control required when using economizer.
- ④ Do not use with electronic thermostats.
- ⑤ It is the responsibility of the installing dealer to properly size the ductwork for each specific application.
- ⑥ BAYCOVR112,118A will not cover BAYSQRD002B applications.
- ⑦ Does not contain barometric relief.
- ⑧ Max fresh air - 25%.
- ⑨ For non-continuous fan gas-heating applications, the damper opens only when the OD ambient is above 50° F.
- ⑩ It is the designer/engineer/installer's responsibility to review product specifications and technical literature to insure optimal performance and compliance to codes.
- ⑪ Temperature of mixed air entering the heat exchanger is monitored and fresh air intake may be reduced under certain conditions.
- ⑫ BAYACCDOR1A requires BAYFLTR101B & BAYACCDOR2A requires BAYFLTR201B. They are not backward compatible to BAYFLTR101/201A.
- ⑬ BAYOSAC001B is not compatible with BAYACCDOR1A or BAYACCDOR2A
- ⑭ When using a BAYACCDOR2A, two 18x20 filters are required.

EXISTING CURB	NEW UNIT 4TC/WC/YC****A	USE BAYADAP0**A
BAYCURB030,38A	024-036	50
BAYCURB030,38A	042-060	52
BAYCURB033A	024-036	51
BAYCURB033A	042-060	53
BAYCURB034A	042-060	54

**For dimensional/outline drawings, please refer to Product Data.
For information on Roof Curbs, please refer to the Accessories/Information Tab.**

For complete equipment / combination selections, installation instructions and warranty information, please refer to Product Data/Ratings and/or Installers Guides and Limited Warranty Handbooks.

BUILT TO A HIGHER STANDARD™

American Standard
HEATING & AIR CONDITIONING

Single Power Entry Kits Packaged Convertible 2-5 Tons

Single Power Entry Kits - Packaged

	SINGLE POWER ENTRY KIT	HEATER	4TCC4	4TCY5	4WCC4	4WCY5	4WCZ6
SINGLE PHASE (208-240v)	BAYSPEK060	BAYHTRV105	2-4	2-5	2-3	2-3½	2-3
		BAYHTRV108	2-4	2-5	2	—	—
		BAYHTRV110	2-4	2-3	—	—	—
	BAYSPEK062	BAYHTRV105	5	—	3½-5	4-5	4-5
		BAYHTRV108	5	—	2½-5	2-5	2-5
		BAYHTRV110	5	3½-5	2-5	2-5	2-5
	BAYSPEK063	BAYHTRV115	2½-5	2½-5	2½-5	2½-5	3-5
		BAYHTRV120	4-5	3½-5	3½-5	3½-5	4-5

	SINGLE POWER ENTRY KIT	HEATER	4TCC3	4TCX3	4TCY4	4WCC3	4WCX3	4WCY4	4WCZ6
3 PHASE (208/240v)	BAYSPEK064	BAYHTRV315	—	—	—	3-5	3-5	3-5	3-5
		BAYHTRV320	4-5	4-5	4-5	4-5	4-5	4-5	4-5
	BAYSPEK065	BAYHTRV310	—	—	—	5	5	5	5
	BAYSPEK061	BAYHTRV305	3-5	3-5	3-5	3-5	3-5	3-5	3-5
		BAYHTRV308	3-5	3-5	3-5	3-5	3-5	3-5	3-5
		BAYHTRV310	3-5	3-5	3-5	3-4	3-4	3-4	3-4
		BAYHTRV315	3-5	3-5	3-5	—	—	—	—
3 PHASE (460v)	BAYSPEK061	BAYHTRV405	3-5	3-5	—	3-5	3-5	—	3-5
		BAYHTRV408	3-5	3-5	—	3-5	3-5	—	3-5
		BAYHTRV410	3-5	3-5	—	3-5	3-5	—	3-5
		BAYHTRV415	3-5	3-5	—	3-5	3-5	—	3-5
		BAYHTRV420	4-5	4-5	—	4-5	4-5	—	4-5

For dimensional/outline drawings, please refer to Product Data.

For information on Roof Curbs, please refer to the Accessories/Information Tab.

For complete equipment / combination selections, installation instructions and warranty information, please refer to Product Data/Ratings and/or Installers Guides and Limited Warranty Handbooks.

BUILT TO A HIGHER STANDARD[®]

American Standard[®]
HEATING & AIR CONDITIONING

Supplemental Heater Table Packaged Convertible 2-5 Tons

	BAYHTRV105 3.76/5.0 kW	BAYHTRV108 6.0/8.0 kW	BAYHTRV110 7.50/10.0 kW	BAYHTRV115 11.27/15.0 kW	BAYHTRV120 15.00/20.0 kW	BAYHTRV125 18.78/25.0 kW
4TCY5024A1	Y	Y	Y	--	--	--
4TCY5030A1	Y	Y	Y	Y	--	--
4TCY5036A1	Y	Y	Y	Y	--	--
4TCY5042A1	Y	Y	Y	Y	Y	Y
4TCY5048A1	Y	Y	Y	Y	Y	Y
4TCY5060A1	Y	Y	Y	Y	Y	Y
4TCC4024A1	Y	Y	Y	--	--	--
4TCC4030A1	Y	Y	Y	Y	--	--
4TCC4036A1	Y	Y	Y	Y	--	--
4TCC4042A1	Y	Y	Y	Y	--	--
4TCC4048A1	Y	Y	Y	Y	Y	--
4TCC4060A1	Y	Y	Y	Y	Y	Y
4WCZ6024A1	Y	Y	Y	--	--	--
4WCZ6036B1	Y	Y	Y	Y	--	--
4WCZ6048B1	Y	Y	Y	Y	Y	Y
4WCZ6060B1	Y	Y	Y	Y	Y	Y
4WCY5024A1	Y	Y	Y	--	--	--
4WCY5030A1	Y	Y	Y	Y	--	--
4WCY5036A1	Y	Y	Y	Y	--	--
4WCY5042A1	Y	Y	Y	Y	Y	Y
4WCY5048A1	Y	Y	Y	Y	Y	Y
4WCY5060A1	Y	Y	Y	Y	Y	Y
4WCC4024A1	Y	Y	Y	--	--	--
4WCC4030A1	Y	Y	Y	Y	--	--
4WCC4036A1	Y	Y	Y	Y	--	--
4WCC4042A1	Y	Y	Y	Y	--	--
4WCC4048A1	Y	Y	Y	Y	Y	--
4WCC4060A1	Y	Y	Y	Y	Y	Y

**For dimensional/outline drawings, please refer to Product Data.
For information on Roof Curbs, please refer to the Accessories/Information Tab.**

For complete equipment / combination selections,
installation instructions and warranty information,
please refer to Product Data/Ratings and/or Installers
Guides and Limited Warranty Handbooks.

Supplemental Heater Table Packaged Convertible 2-5 Tons

	BAYHTRV305 3.76/5.0 kW (3PH)	BAYHTRV308 6.0/8.0 kW (3PH)	BAYHTRV310 7.50/10.0 kW (1PH)	BAYHTRV315 11.27/15.0 kW (3PH)	BAYHTRV320 15.0/20.0 kW (3PH)	BAYHTRV325 18.78/25.0 kW (3PH)
4TCY4036B3	Y	Y	Y	Y	--	--
4TCY4048B3	Y	Y	Y	Y	Y	Y
4TCY4060B3	Y	Y	Y	Y	Y	Y
4TCX3036A3	Y	Y	Y	Y	--	--
4TCX3048A3	Y	Y	Y	Y	Y	--
4TCX3060A3	Y	Y	Y	Y	Y	Y
4TCC3036A3	Y	Y	Y	Y	--	--
4TCC3048A3	Y	Y	Y	Y	Y	--
4TCC3060A3	Y	Y	Y	Y	Y	Y
4WCZ6036B3	Y	Y	Y	Y	--	--
4WCZ6048B3	Y	Y	Y	Y	Y	Y
4WCZ6060B3	Y	Y	Y	Y	Y	Y
4WCY4036A3	Y	Y	Y	Y	--	--
4WCY4048A3	Y	Y	Y	Y	Y	--
4WCY4060B3	Y	Y	Y	Y	Y	--
4WCX3036A3	Y	Y	Y	Y	--	--
4WCX3048A3	Y	Y	Y	Y	Y	--
4WCX3060A3	Y	Y	Y	Y	Y	Y
4WCC3036A3	Y	Y	Y	Y	--	--
4WCC3048A3	Y	Y	Y	Y	Y	--
4WCC3060A3	Y	Y	Y	Y	Y	Y
	BAYHTRV405 5.0 kW (3PH)	BAYHTRV408 8.0 kW (480V 3 PH)	BAYHTRV410 10.0 kW (3PH)	BAYHTRV415 15.0 kW (480V 3 PH)	BAYHTRV420 20.0 kW (480V 3 PH)	BAYHTRV425 25.0 kW (480V 3 PH)
4TCX3036A4	Y	Y	Y	Y	--	--
4TCX3048A4	Y	Y	Y	Y	Y	--
4TCX3060A4	Y	Y	Y	Y	Y	Y
4TCC3036A4	Y	Y	Y	Y	--	--
4TCC3048A4	Y	Y	Y	Y	Y	--
4TCC3060A4	Y	Y	Y	Y	Y	Y
4WCZ6036B4	Y	Y	Y	Y	--	--
4WCZ6048B4	Y	Y	Y	Y	Y	--
4WCZ6060B4	Y	Y	Y	Y	Y	--
4WCX3036A4	Y	Y	Y	Y	--	--
4WCX3048A4	Y	Y	Y	Y	Y	--
4WCX3060A4	Y	Y	Y	Y	Y	Y
4WCC3036A4	Y	Y	Y	Y	--	--
4WCC3048A4	Y	Y	Y	Y	Y	--
4WCC3060A4	Y	Y	Y	Y	Y	Y

**For dimensional/outline drawings, please refer to Product Data.
 For information on Roof Curbs, please refer to the Accessories/Information Tab.**

For complete equipment / combination selections,
 installation instructions and warranty information,
 please refer to Product Data/Ratings and/or Installers
 Guides and Limited Warranty Handbooks.

Roof Curbs

BAYCURB050A FULL PERIMETER ROOF MOUNTING CURB OUTLINE

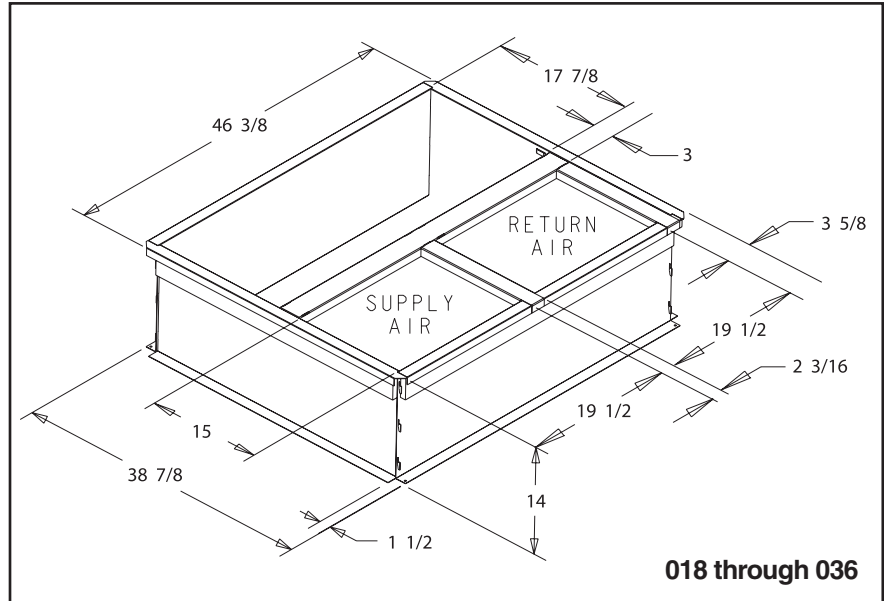

Full Perimeter BAYCURB050A	Full Perimeter BAYCURB051A
4TCY4024-036	4TCY4042-060
4TCX3018-036/4TCC3018-036	4TCX3042-060/4TCC3042-060
4WCZ6036/4DCZ6036	4WCZ6048-060/4DCZ6048-060
4WCY4024-036/4DCY4024-036	4WCY4042-060/4DCY4042-060
2/4WCX3018-036/2/4WCC3018-036	2/4WCX3042-060/2/4WCC3042-060
4YCZ6036	4YCZ6048-060
4YCY4024-036	4YCY4042-060
2/4YCX3018-036/2/4YCC3018-036	2/4YCX3042-060/2/4YCC3042-060

BAYCURB051A FULL PERIMETER ROOF MOUNTING CURB OUTLINE

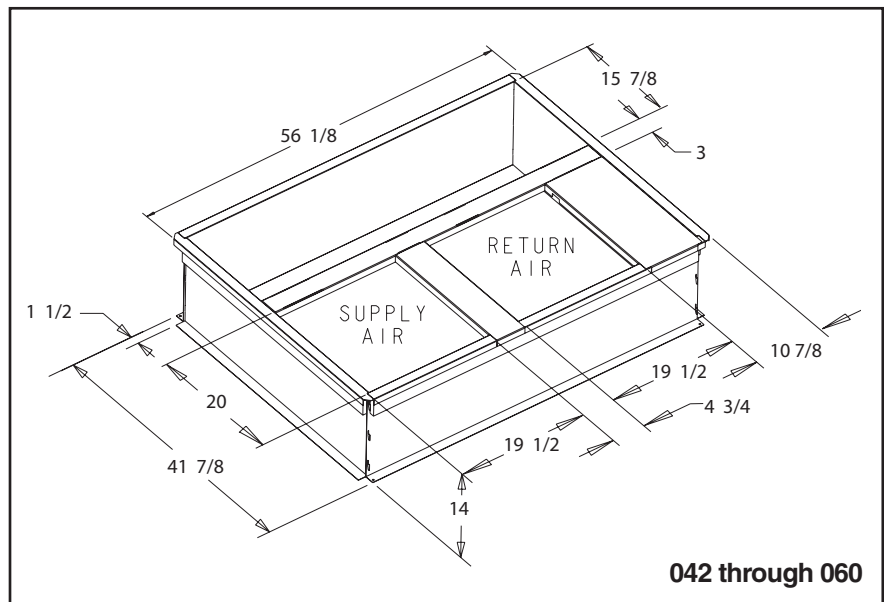

Accessories/Information

Thermal Expansion Valves

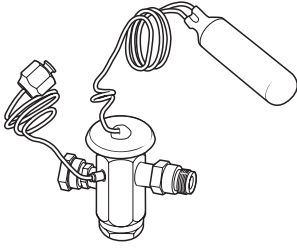

**Expansion Valve TXV
Cooling/Heat Pump Kit**

General Information

This Thermostatic Expansion Valve Kit may be used on any indoor air handler or coil that is equipped with a current thermostatic expansion valve with an internal check valve and mechanical fittings. This kit can be used on split system heat pumps and air conditioning systems.

Thermostatic Expansion Valve Kits can be field installed to fit a variety of sizes and combinations of air handlers or coils and outdoor units to optimize performance.

This TXV kit will normally be used when a different refrigerant is going to be used in the air handler or coil than what is indicated on the unit name plate. The TXV type must always match the refrigerant type used in the outdoor unit.

Kit Identification

The first character in the kit model number indicates the type of refrigerant that the valve can be used with. Example a 2AYTXVH3D1830A is an R-22 valve.

The "3" in the eighth digit in the model number identifies the valve as a non-bleed TXV. When this TXV kit is installed with an outdoor unit that contains a reciprocating compressor, the outdoor unit must be equipped with a hard start kit if not factory installed. If the outdoor unit contains a scroll compressor, the installation of a hard start kit may be required.

Inspection

Check carefully for any shipping damage. Any such damage must be reported and claims made against the transportation company immediately. Any missing parts should be reported to your supplier at once and replaced with authorized parts only.

Table AC/IN-2-A Cooling/Heat Pump Non-Bleed TXV Kits- Dual Direction Flow-TXA/C-BC Coils

R-410 Model Number	R-22 Model Numbers	Used With 13 SEER Coils
4AYTXVH3D1831A	2AYTXVH3C1818A	2/4TXC, TXA018
4AYTXVH3D1831A	2AYTXVH3C2425A	2/4TXC, TXA024,025
4AYTXVH3D1831A	2AYTXVH3C3031A	2/4TXC, TXA031
4AYTXVH3D3343A	—4TXC, 4TXA-032	
4AYTXVH3D3343A	2AYTXVH3C3337A	2/4TXC, TXA036,037
4AYTXVH3D3343A	2AYTXVH3C4243A	2/4TXC, TXA042,043
4AYTXVH3D4863A	—4TXC, 4TXA-044	
4AYTXVH3D4863A	2AYTXVH3C4850A	2/4TXC, TXA048,049,050
4AYTXVH3D4863A	2AYTXVH3C5463A	2/4TXC, TXA060,061,064

Table AC/IN-2-B Cooling/Heat Pump Non-Bleed TXV Kits- Dual Direction Flow

R-410 Model Number	R-22 Model Number	Used With Horizontal Flat Coils
4AYTXVH3D1831A	2AYTXVH3C1818A	2/4TXF-018
4AYTXVH3D3343A	2AYTXVH3C3337A	2/4TXF-033
4AYTXVH3D3343A	2AYTXVH3C4243A	2/4TXF-041
4AYTXVH3D4863A	2AYTXVH3C5463A	2/4TXF-054
4AYTXVH3D4863A	2AYTXVH3C5463A	2/4TXF-063

Table AC/IN-2-C Cooling/Heat Pump Non-Bleed TXV Kits- Dual Direction Flow-TXA/C-AS Coils

R-410 Model Number	R-22 Model Number	Used With AS Aluminum Coils
4AYTXVH3B2531A	2AYTXVH3B2531A	2/4TXA, TXC-025
4AYTXVH3B2531A	2AYTXVH3B2531A	2/4TXA, TXC-031
4AYTXVH3B3654A	2AYTXVH3B3637A	2/4TXA, TXC-036
4AYTXVH3B3654A	2AYTXVH3B3637A	2/4TXA, TXC-037
4AYTXVH3B3654A	2AYTXVH3B5454A	2/4TXA, TXC-054
4AYTXVH3B6165A	2AYTXVH3B6565A	2/4TXA, TXC-065

Table AC/IN-2-D Cooling/Heat Pump Non-Bleed TXV Kits – Dual Direction Flow 4NXA/4NXC

R-22 Number	Used With 4NXA & 4NXC Coils
2AYTXVH3E1824AA	4NXA, NXC – 018 - 024
2AYTXVH3E2536AA	4NXA, NXC – 025 - 036
2AYTXVH3E6363AA	4NXC - 063

Table AC/IN-2-E Cooling/Heat Pump Non-Bleed TXV Kits- Dual Direction Flow

R-410 Number	R-22 Numbers	Used With Air Handlers
4AYTXVH3D1830A	2AYTXVH3D1830A	2TFB-018-030
4AYTXVH3D1831A	2AYTXVH3D1830A	2TFB-036
4AYTXVH3D1831A	2AYTXVH3D1830A	2/4TFE-025
4AYTXVH3D1831A	2AYTXVH3D1830A	2/4TEC-018-030
—	2AYTXVH3D3636A	2/4TEC-036
4AYTXVH3D3642A	—	2/4TEC-036-042
—	2AYTXVH3D4260A	2/4TEC-042-060
4AYTXVH3D4863A	—	2/4TEC-048-060
4AYTXVH3D1831A	2AYTXVH3D1830A	2/4TEH-018-030
—	2AYTXVH3D3636A	4TEH-036
4AYTXVH3D3642A	—	2TEH-036-042
—	2AYTXVH3D4260A	4TEH-042-060
4AYTXVH3D4863A	—	2TEH-048-060
4AYTXVH3D1800A	2AYTXVH3D1830A	2/4TGB-018
4AYTXVH3D1830A	2AYTXVH3D1830A	2/4TGB-025
4AYTXVH3D1831A	2AYTXVH3D1830A	2/4TGB-030
4AYTXVH3D3600A	2AYTXVH3D1830A	2/4TGB-036
4AYTXVH3D3343A	2AYTXVH3D4260A	2/4TGB-042
4AYTXVH3D4863A	2AYTXVH3D4260A	2/4TGB-048
4AYTXVH3D3642A	2AYTXVH3D4260A	2/4TEE-039
4AYTXVH3D4863A	2AYTXVH3D4260A	2/4TEE-048-064

For complete equipment / combination selections, installation instructions and warranty information, please refer to Product Data/Ratings and/or Installers Guides and Limited Warranty Handbooks.

Thermal Expansion Valves

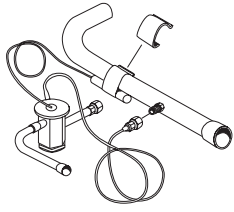

Table AC/IN-3-A — Cooling Bleed TXV Kits – Single Direction Flow

Model Number	Used With AC Units	Liquid Line Connection Dia. I.D. (In.)	Gas Line Connection Dia. I.D. (In.)	Shipping Weight (lbs.)	Refrigerant
TAYTXVA0B5C	1-1½ Ton	¼	⅝	2	R-22
TAYTXVA0C5C	2-2½ Ton	⅝ ₁₆	¾	2	R-22
TAYTXVA0E5C	3-3½ Ton	⅜	⅞	2	R-22
TAYTXVA0G5C	4 Ton	⅜	1 ⅛	2	R-22
TAYTXVA0H5C	5-6 Ton	⅜	1 ⅛	2	R-22

Expansion Valve TXV Cooling Kit

Table AC/IN-3-B — Cooling Non-Bleed TXV Kits – Single Direction Flow

Model Number	Used With AC Units	Liquid Line Connection Dia. I.D. (In.)	Gas Line Connection Dia. I.D. (In.)	Shipping Weight (lbs.)	Refrigerant
TAYTXVA0B3C	1-1½ Ton	¼	⅝	2	R-22
TAYTXVA0C3C	2-2½ Ton	⅝ ₁₆	¾	2	R-22
TAYTXVA0E3C	3-3½ Ton	⅜	⅞	2	R-22
TAYTXVA0G3C	4 Ton	⅜	1 ⅛	2	R-22
TAYTXVA0H3C	5-6 Ton	⅜	1 ⅛	2	R-22

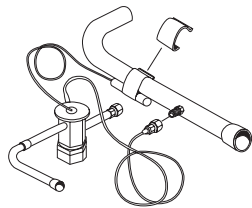

Table AC/IN-3-C — Heat Pump Non-Bleed TXV Kits (also for cooling) – Dual Direction Flow

Model Number	Used With AC Units	Liquid Line Connection Dia. I.D. (In.)	Gas Line Connection Dia. I.D. (In.)	Shipping Weight (lbs.)	Refrigerant
TAYTXVH0B3C	1-1½ Ton	¼	⅝	3	R-22
TAYTXVH0C3C	2-2½ Ton	⅝ ₁₆	¾	3	R-22
TAYTXVH0E3C	3-3½ Ton	⅜	⅞	3	R-22
TAYTXVH0G3C	4 Ton	⅜	1 ⅛	3	R-22
TAYTXVH0H3C	5-6 Ton	⅜	1 ⅛	3	R-22

Expansion Valve TXV Heat Pump Kit*

Table AC/IN-3-D — Cooling/Heat Pump Non-Bleed TXV Kits - Dual Direction Flow*

Model Number	Used With AC Units	Liquid Line Connection Dia. I.D. (In.)	Gas Line Connection Dia. I.D. (In.)	Shipping Weight (lbs.)	Refrigerant
TAYTXVH0D3C	2½ -3 Ton	⅜	1 ⅛	2	R-22
TAYTXVH0G3C	4-5 Ton	⅜	1 ⅛	2	R-22

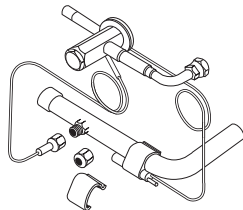

Table AC/IN-3-E — R-410A Heat Pump Non-Bleed TXV Kits (also for cooling) - Dual direction flow

Model Number	Used With HP/AC Units	Liquid Line Connection Dia. I.D. (In.)	Gas Line Connection Dia. I.D. (In.)	Shipping Weight (lbs.)	Refrigerant
4AYTXVH3A1830A	1½-2½ Ton	⅝ ₁₆ ①	¾②	2	R-410A
4AYTXVH3A3654A	3-4 Ton	⅜	⅞③	2	R-410A
4AYTXVH3A6060A	5 Ton	⅜	⅞	2	R-410A

- ① 1 1/2 ton requires 1/4" liquid line; reducer fittings provided.
 - ② 1 1/2 ton requires 1/2" suction line, 2 ton requires 5/8; reducer fittings provided.
 - ③ 3 & 3 1/2 ton requires 3/4" suction line; reducer fitting provided.
- * Used with TXH coils only where approved for use with 2 compressor systems.

Notes:

- Use in place of FCCV (Above) on air handlers and coils
- Match TXV kit size to outdoor nominal cooling capacity
- Braze field connections

Equipment Date Identification

1980 – 2009

The nine digit serial numbers on all American Standard central air conditioning and heating products are employed to identify the year and fiscal week of product manufacture.

Year of manufacture First digit..... **M124X04CF**
 Fiscal week of manufacture..... Second and third digit **M124X04CF**
 Day of week of manufacture..... Fourth digit **M124X04CF**
 Consecutive order of production Last Five digits **M124X04CF**

Exception – Accessories are an exception to the nine digit serial number assignment and may have only three digits to indicate date code. Coils which have only three digits to indicate date code are an exception to the nine digit serial number assignment.

Accessories/Information

Year	Residential, ID & OD ^① Light Commercial Products & Compressors	Ducane Oil ^① Horizontal Gas Furnaces ^②	Year	Residential, ID & OD ^① Light Commercial Products & Compressors	Ducane Oil ^① Horizontal Gas Furnaces ^②	Year	Residential, ID & OD ^① Light Commercial Products & Compressors	Ducane Oil ^① Horizontal Gas Furnaces ^②
1980	O, A	L	1997	M	97	2014	14	—
1981	T	M	1998	N	98	2015	15	—
1982	U	N	1999	P	99	2016	16	—
1983	W	9	2000	R	—	2017	17	—
1984	X	Q	2001	Z	—	2018	18	—
1985	Y	85	2002	2	—	2019	19	—
1986	S	86	2003	3	—			
1987	B	87	2004	4	—			
1988	C	88	2005	5	—			
1989	D	89	2006	6	—			
1990	E	90	2007	7	—			
1991	F	91	2008	8	—			
1992	G	92	2009	9 or 09	—			
1993	H	93	2010	10	—			
1994	J	94	2011	11	—			
1995	K	95	2012	12	—			
1996	L	96	2013	13	—			

① **Beginning with 1/1/96 (L01) Ducane oil furnace production uses same date code method as gas furnace. Prior to 1/1/96 Ducane serial number used last four digits = date code**, example HA1234569540 1995, 40th week.

Example: 123456-**8 5 4 0**

Year of manufacture _____ Fiscal week of manufacture _____

② **Dedicated horizontal gas furnaces, production ceased after introduction of convertible furnaces. 2010**

Digit	Description	Current Digit Value Options
1 ST	Second to Last integer of the current calendar year	1 through 9 and blank space, Blank Space used when 0 (zero)
2 ND	Last integer of the current calendar year	0 through 9
3 RD	Fiscal Week (Tens numeral)	0 through 5
4 TH	Fiscal Week (Units numeral)	0 through 9
5 TH	Day of the Week	1 through 7
6 TH	Time Stamp	A through Z and 0 through 9, excluding I, O, Q, V, Y, and Z
7 TH	Time Stamp	A through Z and 0 through 9, excluding I, O, Q, V, Y, and Z
8 TH	Time Stamp	A through Z and 0 through 9, excluding I, O, Q, V, Y, and Z
9 TH	Assembly Line Designator	A through Z and 0 through 9, excluding I, O, Q, V, Y, and Z
10 TH	Plant Code	A, D, F, G, H, V, Y, X

Plant Codes: (starting around 1995)
A = Monterrey
D = Springhill, LA (used to be the last character of a 10 digit serial on Ft. Smith products when they were sold commercially back in the late 1980's)
F = Tyler, TX
G = Trenton, NJ
H = Ft. Smith, AR
L = Lynn Haven, FL
V = Vidalia, GA
X = Sourced products

Refrigerant Line Sets

Table AC/IN-5-A — Refrigerant Line Sets

Model Number	Gas Line ^{①②} Dia. O.D.	Liquid Line Dia. O.D.	Length	Shipping Weight
TAYREFLN325	7/8	3/8	25	20
TAYREFLN330	7/8	3/8	30	24
TAYREFLN340	7/8	3/8	40	30
TAYREFLN350	7/8	3/8	50	39
TAYREFLN725	3/4	3/8	25	19
TAYREFLN730	3/4	3/8	30	22
TAYREFLN740	3/4	3/8	40	28
TAYREFLN750	3/4	3/8	50	35
TAYREFLN950	5/8	3/8	50	30

① Gas line 90° bend one end.

② Gas line insulation 3/4" thickness.

Note: Contains a holding charge of Nitrogen.

Table AC/IN-5-B — Refrigerant Line Sets

Model Number	Res Old Accs Part Number	Gas Line Dia. O.D.	Liquid Line Dia.O.D.	Length	Insulation	Insulation Type	Bend	Plain Ends	Flare Fittings	Shipping Weight (per carton)
KIT17586		3/4"	3/8"	50	1/2"	Ez Pull	No	Yes	No	25
KIT16990	TAYREFLN750	3/4"	3/8"	50	1/2"	Standard	No	Yes	No	25
KIT17583		3/4"	3/8"	35	1/2"	Ez Pull	No	Yes	No	19
KIT17000	TAYREFLN730	3/4"	3/8"	30	1/2"	Standard	No	Yes	No	16
KIT16980		3/4"	3/8"	50	3/8"	Standard	No	Yes	No	24
KIT17001		3/4"	3/8"	35	3/8"	Standard	No	Yes	No	17
KIT17596		7/8"	3/8"	50	1/2"	Ez Pull	No	Yes	No	32
KIT16992	TAYREFLN350	7/8"	3/8"	50	1/2"	Standard	No	Yes	No	32
KIT17593		7/8"	3/8"	35	1/2"	Ez Pull	No	Yes	No	23
KIT17006	TAYREFLN330	7/8"	3/8"	30	1/2"	Standard	No	Yes	No	20
KIT16978		7/8"	3/8"	50	3/8"	Standard	No	Yes	No	31
KIT17002		7/8"	3/8"	35	3/8"	Standard	No	Yes	No	22
KIT17656	TAYREFLN965	5/8"	3/8"	50	1/2"	Mini Split Ez Pull	No	No	Yes	24
KIT17655	TAYREFLN960	5/8"	3/8"	25	1/2"	Mini Split Ez Pull	No	No	Yes	13
KIT17650	TAYREFLN060	3/8"	1/4"	50	1/2"	Mini Split Ez Pull	No	No	Yes	15
KIT17649	TAYREFLN050	3/8"	1/4"	25	1/2"	Mini Split Ez Pull	No	No	Yes	9
KIT17652	TAYREFLN570	1/2"	1/4"	50	1/2"	Mini Split Ez Pull	No	No	Yes	18
KIT17651	TAYREFLN560	1/2"	1/4"	25	1/2"	Mini Split Ez Pull	No	No	Yes	10
KIT17806	TAYREFLN165	5/8"	1/4"	50	1/2"	Mini Split Ez Pull	No	No	Yes	22
KIT17805	TAYREFLN155	5/8"	1/4"	25	1/2"	Mini Split Ez Pull	No	No	Yes	12
KIT17715		3/8"	NO	164	1/2"	Ez Pull	No	Yes	No	25
KIT17906		1/4"	NO	164	1/2"	Ez Pull	No	Yes	No	19
KIT17907		1/2"	NO	164	1/2"	Ez Pull	No	Yes	No	35
KIT17723		5/8"	NO	164	1/2"	Ez Pull	No	Yes	No	46

Refrigerant HFC 410A (R-410A)

Tables contain no allowances for vertical lift!

Table AC/IN-6-A — Liquid Line Selection Table for R-410A Single Speed Systems

Maximum Allowable Liquid Line Pressure Drop =

Subtract .43 PSI for each foot of Liquid Lift (if any)

Do Not Exceed this value when selecting Liquid Line.

Tube O.D.	Rated BTUH	Pressure Drop (PSI) For Total Equivalent Length											
		20'	40'	60'	80'	100'	120'	140'	160'	180'	200'	220'	240'
1/4"	15000	4.5	9.0	13.6	18.1	22.6	27.1	31.6	36.2	40.7	45.2	49.7	—
	18000	6.3	12.6	18.8	25.1	31.4	37.7	44.0	—	—	—	—	—
	24000	15.4	30.8	46.2	—	—	—	—	—	—	—	—	—
5/16"	15000	1.2	2.4	3.5	4.7	5.9	7.1	8.3	9.4	10.6	11.8	13.0	14.2
	18000	1.6	3.3	4.9	6.6	8.2	9.8	11.5	13.1	14.8	16.4	18.0	19.7
	24000	2.8	5.5	8.3	11.0	13.8	16.6	19.3	22.1	24.8	27.6	30.4	33.1
	30000	4.1	8.3	12.4	16.6	20.7	24.8	29.0	33.1	37.3	41.4	45.5	49.7
	36000	5.8	11.6	17.3	23.1	28.9	34.7	40.5	46.2	—	—	—	—
3/8"	24000	1.0	1.9	2.9	3.8	4.8	5.8	6.7	7.7	8.6	9.6	10.6	11.5
	30000	1.4	2.9	4.3	5.8	7.2	8.6	10.1	11.5	13.0	14.4	15.8	17.3
	36000	2.0	4.0	6.1	8.1	10.1	12.1	14.1	16.2	18.2	20.2	22.2	24.2
	42000	2.7	5.3	8.0	10.6	13.3	16.0	18.6	21.3	23.9	26.6	29.3	31.9
	48000	3.4	6.8	10.2	13.6	17.0	20.4	23.8	27.2	30.6	34.0	37.4	40.8
1/2"	42000	.5	1.1	1.6	2.2	2.7	3.2	3.8	4.3	4.9	5.4	5.9	6.5
	48000	.7	1.4	2.0	2.7	3.4	4.1	4.8	5.4	6.1	6.8	7.5	8.2
	60000	1.0	2.1	3.1	4.2	5.2	6.2	7.3	8.3	9.4	10.4	11.4	12.5

- Note 1: A blank space indicates a pressure drop of over 50 PSI.
- Note 2: Other existing sources of pressure drop, (solenoid valves, etc.) must be considered.
- Note 3: A vertical run with a heat pump system always results in a liquid lift (heating or cooling).
- Note 4: The smallest liquid line diameter that results in a total liquid line pressure drop of 50 PSI or less results in the most reliable system (fewer pounds of R-410A).
- Note 5: It is recommended to place units where 1/2" liquid line is not required due to the increased refrigerant volume imposed by the larger liquid line.
- Note 6: At the time this manual was printed all outdoor units were rated with 3/8" liquid line.

Table AC/IN-6-B — Allowable Vapor Line Diameters and BTUH Loss (R-410A Single Speed Systems)

Nominal Tons	Tube O.D. (Inches)	Press. Drop PSI/100 Ft.	BTUH Loss For Equivalent Length										
			40'	60'	80'	100'	120'	140'	160'	180'	200'	220'	240'
1.0	1/2	5.0	70	160	250	340	430	520	610	700	790	880	970
	5/8	1.5	20	50	73	100	130	155	180	210	235	265	290
1.5	1/2	10.8	173	410	640	875	1110	1340	1575	1810	2040	2275	2510
	5/8	3.1	50	120	185	250	320	385	450	520	585	655	720
	3/4	1.2	20	45	70	95	125	150	175	200	225	255	280
2.0	5/8	5.4	115	270	430	585	740	895	1050	1205	1360	1515	1670
	3/4	2.0	45	100	160	215	275	330	390	445	505	560	620
2.5	5/8	8.2	220	515	810	1110	1400	1695	1990	2290	2585	2880	3175
	3/4	3.0	80	190	295	405	515	620	730	840	945	1055	1160
	7/8	1.3	35	80	130	175	220	270	315	365	410	455	505
3.0	5/8	11.7	380	885	1390	1895	2400	2905	3410	3915	4425	4930	—
	3/4	4.3	140	325	510	700	880	1070	1255	1440	1625	1810	2000
	7/8	1.9	60	145	225	310	390	470	555	635	720	800	880
3.5	3/4	5.8	220	510	805	1095	1390	1680	1975	2265	2560	2850	3140
	7/8	2.5	95	220	345	475	600	725	850	975	1105	1230	1355
4.0	3/4	7.4	320	745	1170	1600	2025	2450	2875	3305	3730	4155	4580
	7/8	3.2	140	325	510	690	875	1060	1245	1430	1615	1795	1980
	1-1/8	.9	40	90	145	195	245	300	350	400	455	505	555
5.0	3/4	11.5	620	1450	2280	3105	3935	4760	5590	6415	7245	8073	8900
	7/8	4.9	265	615	970	1325	1675	2030	2380	2735	3080	3440	3795
	1-1/8	1.3	70	165	255	350	445	540	630	725	820	915	1005

- Note 1: Shaded value indicates more than 10% capacity loss.
- Note 2: Blank space indicates more than 15% capacity loss.
- Note 3: Only approved for cooling units, do not use 1 1/8" vapor lines on heat pumps less than 5 ton.
- Note 4: If linear length exceeds 150 feet, add 2 ounces of approved compressor oil per every 10 feet in excess of 150 feet. (Example: if the actual line length is 170 feet, add 4 ounces of oil to the system)

This page contains limited data to fully determine if the application will work or to select required accessories. Please refer to publication 14-4050-01 for complete details and examples.

Refrigerant Piping Information for Two Stage Split Systems

Table AC/IN-7-A — Allowable Vapor and Liquid Line Diameters for Two Stage, Single Compressor Split Systems

Rated Line Sizes	Line Sizes		Service Valve Connection Size		Max Line & Lift Lengths	
	Vapor Line	Liquid Line	Vapor Line Connection	Liquid Line Connection	TOTAL Max Line Length (ft)	Max Lift (ft)
2 Ton HP	5/8"	3/8"	5/8"	3/8"	150'	50'
3 Ton HP	3/4"	3/8"	3/4"	3/8"	80'	25'
4 Ton HP	7/8"	3/8"	7/8"	3/8"	150'	50'
5 Ton HP	1-1/8"	3/8"	1-1/8"	3/8"	80'	25'

Alternate Line Sizes	Line Sizes		Service Valve Connection Size		Max Line & Lift Lengths	
	Vapor Line	Liquid Line	Vapor Line Connection	Liquid Line Connection	TOTAL Max Line Length (ft)	Max Lift (ft)
2 Ton HP	5/8"	3/8"	5/8"	3/8"	150'	50'
	3/4"	3/8"			80'	25'
3 Ton HP	5/8"	3/8"	3/4"	3/8"	150'	50'
	7/8"	3/8"			80'	25'
4 Ton HP	3/4"	3/8"	7/8"	3/8"	150'	50'
5 Ton HP	3/4"	3/8"	1-1/8"	3/8"	150'	50'
	7/8"	3/8"			150'	50'

Rated Line Sizes	Line Sizes		Service Valve Connection Size		Max Line & Lift Lengths	
	Vapor Line	Liquid Line	Vapor Line Connection	Liquid Line Connection	TOTAL Max Line Length (ft)	Max Lift (ft)
2 Ton AC	5/8", 3/4"	3/8"	5/8"	3/8"	150'	50'
3 Ton AC	5/8", 3/4", 7/8"	3/8"	3/4"	3/8"	150'	50'
4 Ton AC	3/4", 7/8"	3/8"	7/8"	3/8"	150'	50'
5 Ton AC	3/4", 7/8", 1-1/8"	3/8"	1-1/8"	3/8"	150'	50'

See Application Bulletin SS-APB011-EN

Table AC/IN-7-B — Equivalent Length (Ft.) of Non-Ferrous Valves and Fittings (Brazed)

O.D. Tube Size (Inches)	Globe Valve	Angle Valve	Short Radius Ell	Long Radius Ell	Tee Line Flow	Tee Branch Flow
1/2*	70	24	4.7	3.2	1.7	6.6
5/8	72	25	5.7	3.9	2.3	8.2
3/4	75	25	6.5	4.5	2.9	9.7
7/8	78	28	7.8	5.3	3.7	12.0
1-1/8	87	29	2.7	1.9	2.5	8.0
1-3/8	102	33	3.2	2.2	2.7	10.0
1-5/8	115	34	3.8	2.6	3.0	12.0

Information for this chart extracted by permission from A.R.I. Refrigerant Piping Data, page 28.

* For smaller sizes, use 1/2" values.

This page contains limited data to fully determine if the application will work or to select required accessories. Please refer to publication SS-APG006-EN for complete details and examples.

For complete equipment / combination selections, installation instructions and warranty information, please refer to Product Data/Ratings and/or Installers Guides and Limited Warranty Handbooks.

Split Systems with Variable Speed Compressor

Table AC/IN-8-A — Charge Chart VSPD Side Discharge

R-410A REFRIGERANT CHARGING CHART							
LIQUID TEMP (°F)	DESIGN SUBCOOLING (°F)						
	8	9	10	11	12	13	14
LIQUID GAGE PRESSURE (PSI)							
55	179	182	185	188	191	195	198
60	195	198	201	204	208	211	215
65	211	215	218	222	225	229	232
70	229	232	236	240	243	247	251
75	247	251	255	259	263	267	271
80	267	271	275	279	283	287	291
85	287	291	296	300	304	309	313
90	309	313	318	322	327	331	336
95	331	336	341	346	351	355	360
100	355	360	365	370	376	381	386
105	381	386	391	396	402	407	413
110	407	413	418	424	429	435	441
115	435	441	446	452	458	464	470
120	464	470	476	482	488	495	501
125	495	501	507	514	520	527	533
Refer to Service Facts or Installer's Guide for charging method.							

From Dwg. D154557P01 Rev. 3

Table AC/IN-8-B — Line Sizes VSPD Side Discharge Rated Line Sizes

MODEL	RATED LINE SIZE		SERVICE VALVE CONNECTION SIZE	
	Vapor Line	Liquid Line	Vapor Line	Liquid Line
HP 4A6L9				
HP 024	5/8" (a)	3/8"	5/8"	3/8"
HP 036	3/4" (a)	3/8"	3/4"	3/8"
HP 049	7/8" (a)	3/8"	7/8"	3/8"
HP 060	7/8"(a)(b)	3/8"	7/8"	3/8"

(a) The maximum length of refrigerant lines from outdoor to indoor unit must NOT exceed 150 feet. The maximum vertical change must NOT exceed 50 feet.

(b) Refer to Subcool Charts for length and lift ability.

Table AC/IN-8-C — Alternate Line Sizes VSPD Side Discharge

MODEL	LINE SIZE		SERVICE VALVE SIZE	
	Vapor Line	Liquid Line	Vapor Line	Liquid Line
HP 4A6L9				
HP 024	5/8"	3/8"	5/8"	3/8"
HP 036	5/8", 3/4" (a)	3/8"	3/4"	3/8"
HP 048	3/4", 7/8" (a)	3/8"	7/8"	3/8"
HP 060	3/4", 7/8" (a)(b)	3/8"	7/8"	3/8"

(a) The maximum length of refrigerant lines from outdoor to indoor unit must NOT exceed 150 feet. The maximum vertical change must NOT exceed 50 feet.

(b) Refer to Subcool Charts for length and lift ability.

Notes:

The weigh in method provides an approximation of refrigerant charge; proper charge will vary with indoor coil selections.

In ambient conditions below 55°F, reference the heating refrigerant pressure curves for typical performance.

Return in the cooling season when the ambient temperature is above 55°F to balance the refrigerant charge by subcooling.

Branch Circuit Wire Sizing Table/ Heater De-Rating Chart

BRANCH CIRCUIT WIRE SIZING TABLE

(Based on 2% Voltage Drop)

Chart is based on 75° C. wire. (Types FEPW, RH, RHW, THHW, THW, THWN, XHHW, USE, AND ZW.)
 Use Chart For Wire Sizing Only. Refer To Electrical Code, (Or Product Specs.) For Fuse Sizing

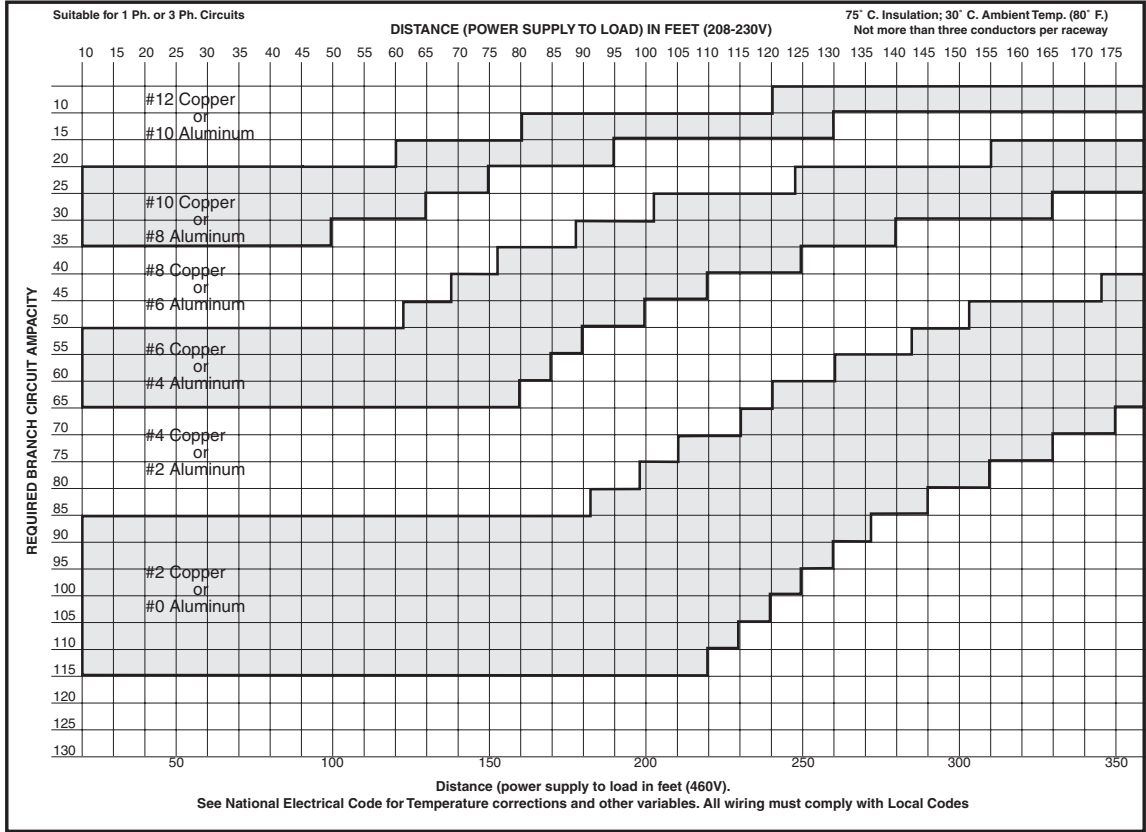

Accessories/Information

Heater De-Rating Chart

The output of electric heaters, applied at voltages other than the rated 240 or 480 volts, can be easily determined with the use of this chart.

ELECTRIC HEATER DE-RATING CHART (for 240V or 480V Rated Heaters Installed on Lower Voltage Systems)

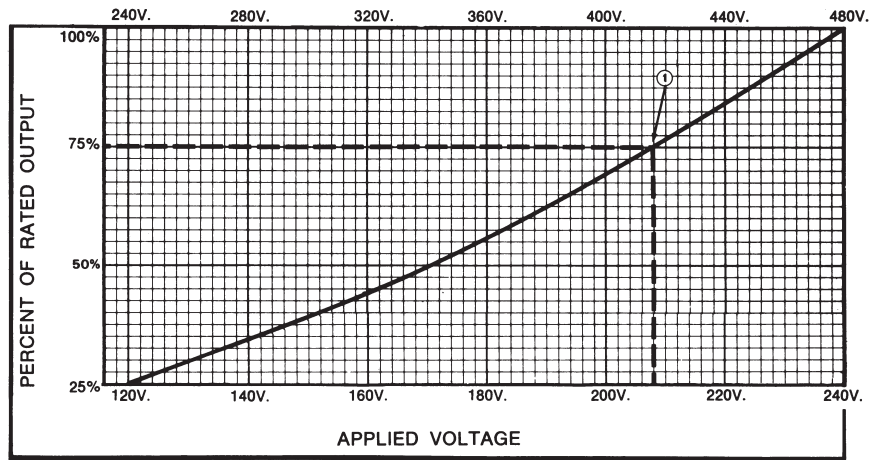

① EXAMPLE: Calculated Heat Loss — 29,200 BTUH Power Supply — 208V.
 The chart indicates that any 240V heater will deliver 75% of its rated capacity at 208V.

$$\frac{29,200 \text{ BTUH}}{.75} = 39,000 \text{ BTUH} \quad \left\{ \begin{array}{l} \text{Select a heater having AT LEAST 39,000 BTUH} \\ \text{capacity at 240V.} \end{array} \right.$$

For complete equipment / combination selections, installation instructions and warranty information, please refer to Product Data/Ratings and/or Installers Guides and Limited Warranty Handbooks.

Basic Air Conditioning Formulas

Basic Air Conditioning Formulas

TO DETERMINE	EXPRESSED AS	COOLING	HEATING and/or HUMIDIFYING
Total Airflow	CFM _T	1. $CFM_T = \frac{N_T V}{60 \text{ min./hr.}}$	1. $CFM_T = \frac{N_T V}{60 \text{ min./hr.}}$
Infiltration or Ventilation	CFM _O	2. $CFM_O = \frac{N_O V}{60 \text{ min./hr.}}$	2. $CFM_O = \frac{N_O V}{60 \text{ min./hr.}}$
Number of Air Changes Per Hour – Total	N _T	3. $N_T = \frac{CFM_T (60 \text{ min./hr.})}{V}$	3. $N_T = \frac{CFM_T (60 \text{ min./hr.})}{V}$
Number of Air Changes Per Hour – Outdoor Air	N _O	4. $N_O = \frac{CFM_O (60 \text{ min./hr.})}{V}$	4. $N_O = \frac{CFM_O (60 \text{ min./hr.})}{V}$
Total Heat (H _T)	Btuh	5. $H_T = CFM_T \times 4.5 \times (h_1 - h_2) = \text{Btuh}$	6. $H_T = CFM_T \times 4.5 \times (h_2 - h_1) = \text{Btuh}$
Sensible Heat (H _S)	Btuh	7. $H_S = CFM_T \times 1.08 \times (T_1 - T_2) = \text{Btuh}$	8. $H_S = CFM_T \times 1.08 \times (T_2 - T_1) = \text{Btuh}$
Latent Heat (H _L)	Btuh	9. $H_L = CFM_T \times .68 \times (W_1 - W_2) = \text{Btuh}$	10. $H_L = CFM_T \times .68 \times (W_2 - W_1) = \text{Btuh}$
Entering Air Temperature (T ₁) (Mixed Air)	°F. D.B.	11. $T_1 = t_1 + \frac{CFM_O}{CFM_T} \times (t_2 - t_1) = \text{°F.D.B. } \textcircled{1}$ $\textcircled{1}$ If duct heat gain is a factor, add to T ₁ : $\frac{\text{Duct Heat Gain (Btuh)}}{CFM_T \times 1.08}$	12. $T_1 = t_1 - \frac{CFM_O}{CFM_T} \times (t_1 - t_2) = \text{°F.D.B. } \textcircled{2}$ $\textcircled{2}$ If duct heat loss is a factor, subtract from T ₁ : $\frac{\text{Duct Heat Loss (Btuh)}}{CFM_T \times 1.08}$
Leaving Air D.B. Temperature (T ₂)	°F. D.B.	13. $T_2 = T_1 - \frac{H_S}{CFM_T \times 1.08} = \text{°F.D.B.}$	14. $T_2 = T_1 + \frac{H_S}{CFM_T \times 1.08} = \text{°F.D.B.}$
Required Airflow	CFM _T	15. $CFM_T = \frac{H_S \text{ (total)}}{1.08 \times (T_1 - T_2)} = \text{CFM}$ OR $CFM_T = \frac{H_S \text{ (internal)} \textcircled{3}}{1.08 \times (t_1 - T_2)} = \text{CFM}$ $\textcircled{3}$ Sensible load of outside air not included	16. $CFM_T = \frac{H_S}{1.08 \times (T_2 - T_1)} = \text{CFM}$
Enthalpy – Leaving Air (h ₂)	Btu/lb. dry air	17. $h_2 = h_1 - \frac{H_T}{CFM_T \times 4.5} = \text{Btu/lb. dry air}$	18. $h_2 = h_1 + \frac{H_T}{CFM_T \times 4.5} = \text{Btu/lb. dry air}$
Leaving Air W.B. Temperature	°F.W.B.	19. Refer to Enthalpy Table and read W.B. temperature corresponding to enthalpy of leaving air (h ₂) (see #17).	20. Refer to Enthalpy Table and read W.B. temperature corresponding to enthalpy of leaving air (h ₂) (see #18).
Heat Required to Evaporate Water Vapor Added to Ventilation Air	Btuh	21. $H_L = CFM_O \times .68 (W_3 - W_O) = \text{Btuh}$	22. $H_L = CFM_O \times .68 (W_3 - W_O) = \text{Btuh}$
Humidification Requirements	Lbs. water/hr.	23. $\left(\text{Make up Moisture} \right) = \frac{\text{Excess Latent Capacity of System} \times \% \text{ Run Time}}{1060 \text{ Btu/lb.}} = \text{lbs./hr.}$ (Industrial Process Work)	24. $\left(\text{Make up Moisture} \right) = \frac{H_L \text{ loss Btuh (see #22)}}{1060 \text{ Btu/lb.}} = \text{lbs./hr.}$

LEGEND	DERIVATION OF AIR CONSTANTS
<p>CFM_T = Total airflow cubic feet/min. CFM_O = Outdoor air cubic feet/min. N_T = Total air changes per hour N_O = Outdoor air, air changes per hour V = Volume of space cubic feet H_T = Total heat Btuh H_S = Sensible heat Btuh H_L = Latent heat Btuh * h₁ = Enthalpy or total heat of entering air * h₂ = Enthalpy or total heat of leaving air T₁ = Temperature of entering air T₂ = Temperature of leaving air T_{adp} = Apparatus dewpoint t₁ = Indoor design temperature t₂ = Outdoor design temperature W₁ = Grains of water/lb. of dry air at entering condition W₂ = Grains of water/lb. of dry air at leaving condition W₃ = Grains of water/lb. of dry air at indoor design conditions W_O = Grains of water/lb. of dry air at outdoor design conditions</p>	<p>The air constants below apply specifically to standard air which is defined as dry air at 70°F and 14.7 P.S.I.A. (29.92 in. mercury column). They can, however, be used in most cooling calculations unless extremely precise results are desired.</p> <p>4.5 (To convert CFM to lbs./hr.)</p> $4.5 = \frac{60 \text{ min./hr.}}{13.33} \text{ or } 60 \times .075$ <p>Where 13.33 is the specific volume of standard air (cu.ft./lb.) and .075 is the density (lbs./cu.ft.)</p> $1.08 = \frac{.24 \times 60}{13.33} \text{ or } .24 \times 4.5$ <p>.24 BTU = specific heat of standard air (BTU/LB./°F)</p> $.68 = \frac{60}{13.33} \times \frac{1060}{7000} \text{ or } 4.5 \times \frac{1060}{7000}$ <p>Where: 1060 = Average Latent Heat of water vapor (BTU/LB.). 7000 = Grains per lb.</p>

* See Enthalpy of air (Total Heat Content of Air) Table for exact values.

Low Ambient Accessories Cooling and Heating Models

Table AC/IN-11-A — Low Ambient Accessories Cooling Models

Low Ambient Accessory For American Standard Residential Cooling Units												
Cooling Unit	55°F	30°F to 55°F			0°F to 30°F or 20°F to 30°F - Please Reference Lowest Approved Outdoor Operating Temperature per Model Family Table							
	As Manufactured	AY28X079	TXV-NB	CCHT	BAYLOAM103*	BAYLOAM107A*	AY28X079	TXV-NB	Start Kit	Compressor Crankcase Heater	Windshield	Liquid Line Solenoid Valve
4A7C3 ①	X	X	X	X	X		X	X	N/A	X	X	X
4A7C4 4A7C7	X	X	X	X	X		X	X	N/A	X	X	X
4A7A3	X	X	X	X	X		X	X	X	X	X	X
4A7A4-L	X	X	X	X	X		X	X	X	X	X	X
4A7L6 ②	X	X	X	X		X	X	X	X	X	X	X
4A7A6-J 4A7A7	X	X	X	X	X		X	X	X	X	X	X
4A7V8	X	NOT APPROVED										
4A7V00	X	NOT APPROVED										

Table AC/IN-11-B - Low Ambient Accessories Heating Models

Low Ambient Accessory For American Standard Residential Heat Pump Units Operating in Cooling												
Heat Pump Unit	55°F	30°F to 55°F			0°F to 30°F or 20°F to 30°F - Please Reference Lowest Approved Outdoor Operating Temperature per Model Family Table							
	As Manufactured	AY28X079	TXV-NB	CCHT	BAYLOAM103*	BAYLOAM107A*	AY28X084	TXV-NB	Start Kit	Compressor Crankcase Heater	Windshield	Liquid Line Solenoid Valve
4A6C4 ①	X	X	X	X		X	X	X	N/A	X	X	
4A6C7	X	X	X	X		X	X	X	N/A	X	X	
4A6H4 4A6H5	X	X	X	X		X	X	X	X	X	X	
4A6H6-H	X	X	X	X		X	X	X	X	X	X	
4A6L6 ①	X	X	X	X		X	X	X	X	X	X	
4A6H7	X	X	X	X		X	X	X	X	X	X	
4A6V8	X	NOT APPROVED										
4A6V00	X	NOT APPROVED										

Charts are for quick reference only. For complete application guidelines, consult the specific SSC-APG***

- ① Reference AMSSP-APG001-EN for complete Low Ambient Guidelines
 - ② Reference SSC-APG014A-EN for Side Discharge Low Ambient Application Guidelines
- Reference SSC-APG012A-EN for complete Low Ambient Guidelines

* **DO NOT Apply BAYLOAM103/107 to model tonnages with variable speed condenser fan motors**

* If Defrost Control is CNT07255, CNT07482 use BAYLOAM107

Table AC/IN-11-C — Lowest Approved Outdoor Operating Temperature for Cooling Operation per Model Family Table

Model Family	Lowest Approved Outdoor Ambient	
	AC	HP
4A7V8 / 4A6V8 / 4A7V00 / 4A6V00	55°F	55°F
4A7C3	0°F	0°F
4A7C4 / 4A6C4 / 4A7C7 / 4A6C7	20°F	10°F
4A7A3	0°F	0°F
4A7A4 / 4A6H4 / 4A6H5	20°F	10°F
4A7A6 / 4A6H6 ** / 4A7L6 / 4A6L6	20°F	10°F
4A7A7 / 4A6H7	20°F	10°F

** Models with variable speed condenser motors are approved to 30°F

For a detailed Application Bulletin on required accessories and wind shields for low outdoor ambient operation, please contact your Territory Manager or Local FSR.

Wind Shields

Wind Shields are required to block prevailing winds across condenser coil. In applications where cooling

operation is required to 0°F, wind shields are a Must. Use the following guidelines for your application.

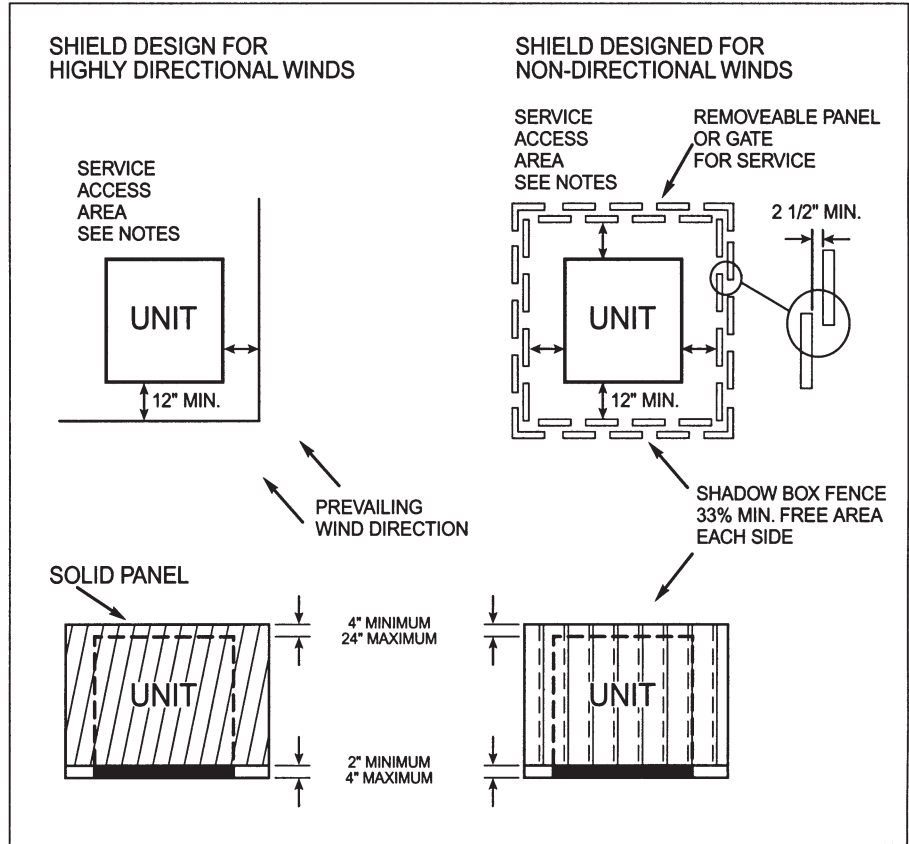

Notes:

Minimum working clearance must be in compliance with the National Electric Code. Currently, the minimum clearance between a wood or suitable grounding material type fence requires minimum 3 feet. If other material is used to form the windshield, the minimum space may be increased to 3.5 feet. Please consult the 2006 Edition of the National Electric Code, Article 110 for the most up to date information, please refer to the most current National Electric Code.

For a detailed Application Bulletin on required accessories and wind shields for low outdoor ambient operation, please contact your Territory Manager or Local FSR.

BUILT TO A HIGHER STANDARD*

American Standard
HEATING & AIR CONDITIONING

Split System Cooling Three Phase – 6-25 Tons, R-410A

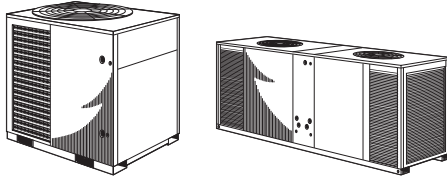

TTA – 6-25 Tons

- ReliaTel™ controls option
- (1) Scroll compressor (TTA072-120A)
- (2) Scroll compressors (TTA072-240D) with independent refrigerant circuits
- Single point power
- Compressor motor overload protection
- Compressor discharge temperature limit switch
- Control transformer
- High and low pressure cut-out switches
- Liquid line filter drier, factory installed
- Electrical phase reversal protection
- Internal pressure relief valves
- Holding charge (Dry Nitrogen)
- All Aluminum microchannel coil
- Low ambient cooling to 50°F as shipped
- Low ambient cooling to 0°F with accessory head pressure control
- Mounting/lifting rails under base
- UL listed
- **5-year compressor warranty**
- **1-year limited parts warranty**
- **Optional Extended Warranties**

Model Number Description — Cooling Condenser

Digit 1-3 — Unit Function
TTA = Split System Cooling

Digit 4-6 — Tonnage

- 072 = 6 Tons (60Hz)
- 090 = 7.5 Tons (60Hz)
- 120 = 10 Tons (60Hz)
- 150 = 12.5 Tons (60Hz)
- 180 = 15 Tons (60Hz)
- 240 = 20 Tons (60Hz)
- 300 = 25 Tons (60Hz)

Digit 7 — Refrigerant

4 = R-410A

Digit 8 — Voltage

- 3 = 208-230VAC - 3 PH (60Hz)
- 4 = 460VAC - 3 PH (60Hz)
- W = 575VAC - 3 PH (60Hz)
- K = 380VAC - 3 PH (60Hz)

Digit 9 — Refrigeration Circuit/Stage

- A = 1 Compressor/1 Line/1 Stage (Single)
- C = 2 Compressors/1 Line/2 Stage (Manifold)
- D = 2 Compressors/2 Line/2 Stage (Duals)

Digit 10 — Major Design Sequence

A = Rev A

Digit 11 — Minor Design Sequence

B = Rev B

Digit 12-13 — Service Digits

00 = 00

Digit 14 — Efficiency Generation

A = Generation A

Digit 15 — Controls

- E = Electromechanical
- R = ReliaTel™

Digit 16 — None

0 = None

Digit 17 — Coil Protection

- 0 = Standard Coil
- 1 = Standard Coil w/ Hail Guard
- 4 = Complete Coat Condenser Coil (MCHE)
- 5 = Complete Coat Condenser Coil with Hail Guard (MCHE)

Digit 18-20 — None

0 = None

Digit 21 — Communications Options

- 0 = No Option
- 2 = LonTalk® Communications Interface (LCI)

Digit 22-40 — None

0 = None

Table LSC-1-A — TTA Split System Cooling — Single Compressor — R-410 Refrigerant

Model Number	Power Supply	AHRI Net Cooling Cap. (BTUH)	Uncrated Dimensions(in.)			Shipping Weight (lbs.)	Sound [Ⓛ] Rating	MCA*	Max. Fuse*	Line Size (in)	
			H	W	L					OD Gas	OD Liq.
TTA07243A	208-230/3/60	76,000	46	45	38	324	84	28	45	1 ¹ / ₈	1 ¹ / ₂
TTA09043A	208-230/3/60	94,000	45	45	38	342	83	34	50	1 ³ / ₈	1 ¹ / ₂
TTA07244A	460/3/60	76,000	46	45	38	324	84	12	20	1 ¹ / ₈	1 ¹ / ₂
TTA09044A	460/3/60	94,000	45	45	38	342	83	17	25	1 ³ / ₈	1 ¹ / ₂
TTA0724WA	575/3/60	76,000	46	45	38	324	84	9	15	1 ¹ / ₈	1 ¹ / ₂
TTA0904WA	575/3/60	94,000	45	45	38	342	83	13	20	1 ³ / ₈	1 ¹ / ₂

Table LSC-1-B — TTA Split System Cooling — Dual Compressors with Two Sets of Refrigerant Circuits - R-410 Refrigerant

Model Number	Power Supply	AHRI Net Cooling Cap. (BTUH)	Uncrated Dimensions(in.)			Shipping Weight (lbs.)	Sound [Ⓛ] Rating	MCA*	Max. Fuse*	Line Size (in)	
			H	W	L					OD Gas	OD Liq.
TTA07243D	208-230/3/60	75,000	45	45	38	344	91	23	30	7 ⁷ / ₈	1 ¹ / ₂
TTA09043D	208-230/3/60	91,000	45	45	38	380	91	33	45	1 ¹ / ₈	1 ¹ / ₂
TTA12043D	208-230/3/60	116,000	45	55	42	436	91	41	50	1 ¹ / ₈	1 ¹ / ₂
TTA15043D	208-230/3/60	150,000	52.1	55	42	504	93	55	70	1 ¹ / ₈	1 ¹ / ₂
TTA18043D	208-230/3/60	186,000	51.1	96	48	806	93	66	90	1 ³ / ₈	1 ¹ / ₂
TTA24043D	208-230/3/60	244,000	51.1	96	48	872	94	87	110	1 ³ / ₈	1 ¹ / ₂
TTA07244D	460/3/60	75,000	45	45	38	344	91	14	20	7 ⁷ / ₈	1 ¹ / ₂
TTA09044D	460/3/60	91,000	45	45	38	380	91	15	20	1 ¹ / ₈	1 ¹ / ₂
TTA12044D	460/3/60	116,000	45	55	42	436	91	20	25	1 ¹ / ₈	1 ¹ / ₂
TTA15044D	460/3/60	150,000	52.1	55	42	504	93	26	35	1 ¹ / ₈	1 ¹ / ₂
TTA18044D	460/3/60	186,000	51.1	96	48	806	93	32	40	1 ³ / ₈	1 ¹ / ₂
TTA24044D	460/3/60	244,000	51.1	96	48	872	94	40	50	1 ³ / ₈	1 ¹ / ₂
TTA0724WD	575/3/60	75,000	45	45	38	344	91	10	15	7 ⁷ / ₈	1 ¹ / ₂
TTA0904WD	575/3/60	91,000	45	45	38	380	91	11	15	1 ¹ / ₈	1 ¹ / ₂
TTA1204WD	575/3/60	116,000	45	55	42	436	91	14	15	1 ¹ / ₈	1 ¹ / ₂
TTA1504WD	575/3/60	150,000	52.1	55	42	504	93	19	25	1 ¹ / ₈	1 ¹ / ₂
TTA1804WD	575/3/60	186,000	51.1	96	48	806	93	25	30	1 ³ / ₈	1 ¹ / ₂
TTA2404WD	575/3/60	244,000	51.1	96	48	872	94	31	40	1 ³ / ₈	1 ¹ / ₂

Ⓛ Sound rating shown is tested in accordance with ARI Standard 270 or 370.

* Information subject to change. Please confirm with current Product Data/Service Facts for current factory production.

For complete equipment / combination selections, installation instructions and warranty information, please refer to Product Data/Ratings and/or Installers Guides and Limited Warranty Handbooks.

BUILT TO A HIGHER STANDARD[®]

American Standard[®]
HEATING & AIR CONDITIONING

Split System Cooling Three Phase – 6-25 Tons, R-410A

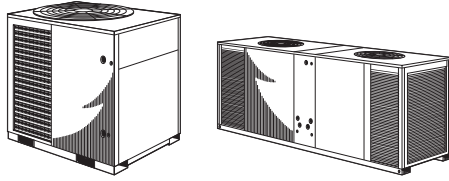

TTA – 6-25 Tons

- ReliaTel™ controls option
- (2) Manifolded scroll compressors
- Single point power
- Compressor motor overload protection
- Compressor discharge temperature limit switch
- Control transformer
- High and low pressure cut-out switches
- Liquid line filter drier, factory installed
- Electrical phase reversal protection
- Internal pressure relief valves
- Holding charge (Dry Nitrogen)
- All aluminum microchannel coil
- Low ambient cooling to 50°F as shipped
- Low ambient cooling to 0°F with accessory head pressure control
- Mounting/lifting rails under base
- UL listed
- **5-year compressor warranty**
- **1-year limited parts warranty**
- **Optional Extended Warranties**

Model Number Description — Cooling Condenser

Digit 1–3 — Unit Function

TTA = Split System Cooling

Digit 4–6 — Tonnage

090 = 7.5 Tons (60Hz)

120 = 10 Tons (60Hz)

180 = 15 Tons (60Hz)

240 = 20 Tons (60Hz)

Digit 7 — Refrigerant

4 = R410A

Digit 8 — Voltage

3 = 208-230VAC - 3 PH (60Hz)

4 = 460VAC - 3 PH (60Hz)

Digit 9 — Refrigeration Circuit/Stage

C = 2 Compressors/1 Line / 2 Stage (Manifold)

Digit 10 — Major Design Sequence

A = Rev A

Digit 11 — Minor Design Sequence

B = Rev B

Digit 12–13 — Service Digits

00 = 00

Digit 14 — Efficiency Generation

A = Generation A

Digit 15 — Controls

E = Electromechanical

Digit 16 — None

0 = None

Digit 17 — Coil Protection

0 = Standard Coil

Digit 18-20 — None

0 = None

Digit 21 — Communications Options

0 = No Option

Digit 22-40 — None

0 = None

Table LSC-2-A — TTA Split System Cooling — Dual Manifolded Compressors with Single Refrigerant Circuits — R-410 Refrigerant

Model Number	Power Supply	AHRI Net Cooling Cap. (BTUH)	Uncrated Dimensions(in.)			Shipping Weight (lbs.)	Sound ^① Rating	MCA*	Max. Fuse*	Line Size (in)	
			H	W	L					OD Gas	OD Liq.
TTA12043C	208-230/3/60	122,000	45	55	42	473	91	41	50	1 ³ / ₈	1/2
TTA18043C	208-230/3/60	184,000	51.1	96	48	806	93	67	90	1 ⁵ / ₈	5/8
TTA24043C	208-230/3/60	250,000	51.1	96	48	879	94	98	125	1 ⁵ / ₈	5/8
TTA30043C	208-230/3/60	296,000	57.1	96	48	1013	94	102	125	2 ¹ / ₈	5/8
TTA12044C	460/3/60	122,000	45	55	42	473	91	20	25	1 ³ / ₈	1/2
TTA18044C	460/3/60	184,000	51.1	96	48	806	93	32	40	1 ⁵ / ₈	5/8
TTA24044C	460/3/60	250,000	51.1	96	48	879	94	47	60	1 ⁵ / ₈	5/8
TTA30044C	460/3/60	296,000	57.1	96	48	1013	94	49	60	2 ¹ / ₈	5/8
TTA1204WC	575/3/60	122,000	45	55	42	473	91	15	20	1 ³ / ₈	1/2
TTA1804WC	575/3/60	184,000	51.1	96	48	806	93	37	50	1 ⁵ / ₈	5/8
TTA2404WC	575/3/60	250,000	51.1	96	48	879	94	39	50	1 ⁵ / ₈	5/8
TTA3004WC	575/3/60	296,000	57.1	96	48	1013	94	42	50	2 ¹ / ₈	5/8

① Sound rating shown is tested in accordance with ARI Standard 270 or 370.

* Information subject to change. Please confirm with current Product Data/Service Facts for current factory production.

Light Commercial
Split System Cooling

For complete equipment / combination selections, installation instructions and warranty information, please refer to Product Data/Ratings and/or Installers Guides and Limited Warranty Handbooks.

LSC-2

Effective 1/1/20

14-1011-37

Split System Cooling Three Phase – 6-25 Tons, R-22

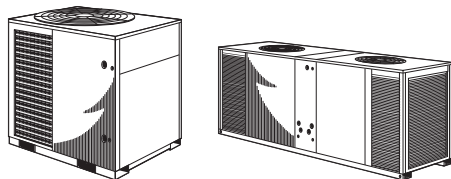

TTA – 6-25 Tons

- Single point power
- Compressor motor overload protection
- Compressor discharge temperature limit switch
- Control transformer
- High and low pressure cut-out switches
- Liquid line filter drier, factory installed
- Electrical phase reversal protection
- Internal pressure relief valves
- Holding charge (Dry Nitrogen)
- All aluminum microchannel coil
- Low ambient cooling to 50°F as shipped
- Low ambient cooling to 0°F with accessory head pressure control
- Mounting/lifting rails under base
- UL listed
- **1-year limited parts warranty**
- **Optional Extended Warranties**

Model Number Description — Cooling Condenser

Digit 1–3 — Unit Function

TTA = Split System Cooling

Digit 4–6 — Tonnage

090 = 7.5 Tons (60Hz)

120 = 10 Tons (60Hz)

180 = 15 Tons (60Hz)

240 = 20 Tons (60Hz)

Digit 7 — Refrigerant

2 = R-22

Digit 8 — Voltage

3 = 208-230VAC - 3 PH (60Hz)

4 = 460VAC - 3 PH (60Hz)

Digit 9 — Refrigeration Circuit/Stage

A = 1 Compressor/1 Line/1 Stage (Single)

D = 2 Compressors/2 Line/2 Stage (Duals)

Digit 10 — Major Design Sequence

B = Rev B

Digit 11 — Minor Design Sequence

A = Rev A

Digit 12–13 — Service Digits

00 = 00

Digit 14 — Efficiency Generation

A = Generation A

Digit 15 — Controls

E = Electromechanical

Digit 16 — None

0 = None

Digit 17 — Coil Protection

0 = Standard Coil

Digit 18-20 — None

0 = None

Digit 21 — Communications Options

0 = No Option

Digit 22-40 — None

0 = None

Table LSC-3-A — TTA Split System Cooling - Single Compressors with Single Refrigerant Circuits - R-22 Refrigerant

Model Number	Power Supply	Nom. Cap. Cooling (BTUH)	Uncrated Dimensions(in.)			Shipping Weight (lbs.)	Sound ^① Rating	MCA*	Max. Fuse*	Line Size	
			H	W	L					OD Gas	OD Liq.
TTA09023A	208-230/3/60	90,000	45	45	38	328	83	31	50	1 ³ / ₈	1 ¹ / ₂
TTA12023A	208-230/3/60	120,000	45	55	42	405	90	43	70	1 ³ / ₈	1 ¹ / ₂
TTA09024A	460/3/60	90,000	45	45	38	328	83	15	25	1 ³ / ₈	1 ¹ / ₂
TTA12024A	460/3/60	120,000	45	55	42	405	90	22	35	1 ³ / ₈	1 ¹ / ₂

Table LSC-3-B — TTA Split System Cooling - Dual Compressors with Dual Refrigerant Circuits - R-22 Refrigerant

Model Number	Power Supply	Nom. Cap. Cooling (BTUH)	Uncrated Dimensions(in.)			Shipping Weight (lbs.)	Sound ^① Rating	MCA*	Max. Fuse*	Line Size	
			H	W	L					OD Gas	OD Liq.
TTA18023D	208-230/3/60	180,000	51.1	96	48	776	83	60	80	1 ³ / ₈	1 ¹ / ₂
TTA24023D	208-230/3/60	240,000	51.1	96	48	922	90	78	100	1 ³ / ₈	1 ¹ / ₂
TTA18024D	460/3/60	180,000	51.1	96	48	776	83	30	40	1 ³ / ₈	1 ¹ / ₂
TTA24024D	460/3/60	240,000	51.1	96	48	922	90	40	50	1 ³ / ₈	1 ¹ / ₂

① Sound rating shown is tested in accordance with ARI Standard 270 or 370.

* Information subject to change. Please confirm with current Product Data/Service Facts for current factory production.

Split System Cooling – R-410A

Accessories Three Phase – 6-25 Tons

Table LSC-4-A — TTA Accessories

Model	Used With
Coil (Hail/Vandal) Guard	
BAYGARD058*	TTA072, TTA090
BAYGARD059*	TTA120
BAYGARD060*	TTA150
BAYGARD061*	TTA180, TTA240
BAYGARD062*	TTA300
Universal Hot Gas Bypass Kit	
BAYHGBP010*	All models
Rubber Isolators	
BAYISLT004* (blue)	TTA072, TTA090
BAYISLT005* (black)	TTA120
BAYISLT009* (red)	TTA150, TTA180
BAYISLT010* (green)	TTA240, TTA300
Steel Spring Isolators	
BAYISLT023* (red)	TTA072, TTA090, TTA120**A
BAYISLT024* (black)	TTA120**C/D, TTA150, TTA180
BAYISLT025* (yellow)	TTA240, TTA300
Service Valve Kit	
BAYVALV001A	TTA0724*A, TTA0904*A, TTA1204*A/C
BAYVALV003A	TTA0724*D, TTA0904*D, TTA1204*D
BAYVALV004A	TTA1504*D
BAYVALV005A	TTA1804*D, TTA2404*D
BAYVALV007A	TTA1804*C, TTA2404*C
BAYVALV008A	TTA3004*C
Low Ambient — On/Off Fan Control (External mount, small cabinets)^{① ② ③}	
BAYLOAMU01* (External Mount, small cabinets) ^④	(all voltages) TTA072, TTA090
BAYLOAMU02* (Internal mount, large cabinets)	(all voltages) TTA120, TTA150, TTA180, TTA240, TTA300
Head Pressure Control^②	
BAYLOAM335* (208–230V, 0.5 HP, Hi-Eff Motor)	TTA072*3A, TTA090*3A
BAYLOAM336* (208–230V, 1 HP, Hi-Eff Motor)	TTA120*3A/C/D, TTA150*3D, TTA180*3C/D, TTA240*3C/D, TTA300*3C
BAYLOAM337* (208-230 V, 0.5HP, Hi-Eff motor)	TTA072*3D, TTA090*3D
BAYLOAM435*(380-460V, 0.5HP Hi-Eff Motor)	TTA072*4A, TTA090*4A
BAYLOAM436*(380-460V, 1 HP Hi-Eff Motor)	TTA120*4A/C/D, TTA150*4D, TTA180*4C/D, TTA240*4C/D, TTA300*4C
BAYLOAM437*(380-460V, 0.5 HP Hi-Eff Motor)	TTA072*4D, TTA090*4D
BAYLOAMW36* (575V, 1 HP, Hi-Eff Motor)	TTA120*WA/C/D, TTA150*WD, TTA180*WC/D, TTA240*WC/D, TTA300*WC
Transducer Kit for Head Pressure Control (BAYLOAM335, 336, 435, 436, W36)	
BAYLOTR001* ^⑤	TTA120**D, TTA150**D
Trane Communication (3/4 Communications Interface)	
BAYICSI003*	All Models
LonTalk Communications Interface^⑥	
BAYLTICI002*	All Models

① Cycles fan on/off (no modulating).

② Quantity of 1 required for each fan (2 total for ton and larger).

③ ReliaTel™ requires onboard EDC function to be disabled when BAYLOAM is used, remove OA sensor from terminal J8-1&2

④ Kit mounts external to the outdoor unit and operates by sensing ambient and liquid line temperatures.

⑤ BAYLOTR001 required when modulating BAYLOAM kits used with units that have 2 compressors (dual circuit) and 1 condenser fan.

Split System Cooling Three Phase – 6-25 Tons

Table LSC-5-A — ReliaTel™ Control Options

Model Number	Description	Used With
ASYSTAT106A	Zone Sensor, Set Point, Fan System	TTA072-TTA300 with ReliaTel™ Controls
ASYSTAT107A	Zone Sensor, Set Point Adj, Fan, System, EH, LED	TTA072-TTA300
ASYSTAT108A	Zone Sensor, 2 Set Point, Fan System	TTA072-TTA300 with ReliaTel™ Controls
ASYSTAT109A	Zone Sensor, 2 Set Point Adj, Fan, System, EH, LED	TTA072-TTA300
ASYSTAT777A	Digital Programmable Zone Sensor with Night Setback	TTA072-TTA300 with ReliaTel™ Controls
BAYSENS050 ^①	Wireless Zone Sensor	TTA072-TTA300 with ReliaTel™ Controls
BAYSENS073A	Room Sensor w/ Override and Cancel Button	TTA072-TTA300 with ReliaTel™ Controls
BAYSENS074A	Room Sensor w/ Temperature Adjustment and Override Button	TTA072-TTA300 with ReliaTel™ Controls
BAYSENS077A	Remote Sensor	ASYSTAT106A-ASYSTAT109A, ASYSTAT777A
BAYSENS110A	Dual Set Point w/ Manual/Auto Change Over	TTA072-TTA300 with ReliaTel™ Controls

Table LSC-5-B — Electromechanical Control Options

Model Number	Description	Used With
ASYSTAT092A	2H/2C Touch Screen Digital Display Programmable Thermostat "Touch Screen"	All
ASYSTAT093A	3H/2C Digital Display Programmable Thermostat W/Humidity Sensor	All

^① Kit comes with everything required for installation and operation.

6 - 25 Tons with ReliaTel™ Controls

Protection/Operation Timings and Features

Anti Short Cycle Timer (ASCT) Function — Provides a three (3) minute minimum “ON” time and a three (3) minute minimum “OFF” time for compressors, enhances compressor reliability by ensuring proper oil return. **Standard**

Built In Fan Delay Relay (FDR) Function — Provides custom indoor fan timing sequences for the different types of equipment, enhancing efficiency and reliability. **Standard**

Built In Night Set Back and Unoccupied Functions① — When using a standard dual setpoint/auto change over Zone Sensor Module (ZSM), this function is enabled by applying a short across terminal J6-11 and J6-12. Sets cooling setpoint up a minimum of 7°F, sets heating setpoint back a minimum of 7°F, and forces fan operation to automatic. **(requires time clock accessory or field supplied/installed switch or contacts).**

Built In “TEST” Mode — Aids in quick verification of system and control operation, exercises both hardware and software (no special tools required). **Standard**

Built In Unoccupied Mode① — When using a standard single setpoint/manual change over Zone Sensor Module (ZSM), this function is enabled by applying a short across terminal J6-11 and J6-12. Forces fan operation to automatic. **(requires time clock accessory or field supplied/installed switch or contacts.)**

Direct Digital Control (DDC)① — Proportional Integral (PI) control. Proportional – sets corrective action proportional to deviation from setpoint. Integral – fine tunes the rate of corrective action proportional to the error (results in superior space temperature control). **Standard**

Increased Reliability — Fewer components (moving electro-mechanical parts), less likelihood of equipment down time or failure. **Standard**

Integral Electric Heat Staging① — Stages electric heaters “OFF” and “ON”, eliminating the use of outdated sequencers. **Standard**

Intelligent Fallback① — A built in Default Control provides adaptive operation, which allows the equipment to continue to operate, providing comfort in the event of certain component failures. Also, allows emergency operation without a Zone Sensor Module (ZSM). **Standard**

Low Ambient Start Timer (LAST) Function — Bypasses low pressure control when a compressor starts, eliminating nuisance compressor lock outs. **Standard**

Lower Installation Cost — Using a standard Zone Sensor Module (ZSM), control voltage wiring may be run up to five (5) times further than any electromechanical system, with no increase in wire gauge. Example: Electromechanical System – 30 feet maximum using 22 gauge wire. Micro Control System – 150 feet using 22 gauge wire. **Standard**

On Board Diagnostics① — Assist with equipment troubleshooting, if a problem occurrence should take place. **Standard**

Remote Sensing① — All standard Zone Sensor Modules (ZSMs) have remote sensing capabilities, typically achieved by using an expensive program-mable thermostat and remote sensor with electromechanical equipment. **Accessory (requires use of remote sensor).**

Space Temperature Averaging① — All standard Zone Sensor Modules (ZSMs) have space temperature averaging capabilities, typically achieved by using an expensive programmable thermostat and minimum of four (4) remote sensors with electromechanical equipment. **Averaging with ReliaTel™ can be achieved with two (2) sensors.**

Time Delay Relay (TDR) Function — Provides an incremental staging delay between compressors, minimizes equipment current inrush and consumption by keeping compressors from starting simultaneously. **Standard**

Low Pressure and High Pressure Compressor Lockout — 3 trips will lockout control.

When the ReliaTel™ RTRM Thermostat Interface is used, equipment operation differs significantly. The basic equipment protection features remain intact, and the following features and benefits are lost:

- Direct Digital Control (DDC) – Proportional Integral (PI) control is lost, equipment is controlled by a thermostat or generic building automation system device.
- Intelligent Fall back is lost, if a failure occurs in the device controlling the equipment, operation will cease.
- Installation is more costly, with the addition of a thermostat or generic control, the control wiring size must be increased.
- Remote Sensing capabilities are lost, unless generic control being applied can accomplish this.
- Space Temperature Averaging capabilities are lost, unless generic control being applied can accomplish this.
- Built In Night Set Back and Unoccupied functions are lost, unless generic control being applied can accomplish this.
- Built In Unoccupied Mode is lost, unless generic control being applied can accomplish this.

① Denotes features lost from utilizing standard conventional stat.

BUILT TO A HIGHER STANDARD

American Standard
HEATING & AIR CONDITIONING

Split System Heat Pumps Three Phase – 6-20 Tons, R-410A

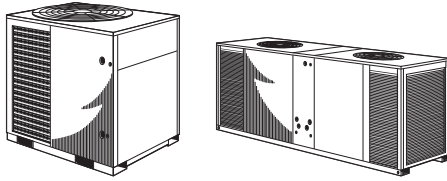

TWA – 6-20 Tons

- ReliaTel™ controls (standard)
- (1) Scroll compressor (TWA072-120A)
- (2) Scroll compressors (TWA072-240D) with independent refrigerant circuits
- Single point power
- Compressor motor overload protection
- Compressor discharge temperature limit switch
- Control transformer
- High and low pressure cut-out switches
- Demand Defrost Control
- Internal pressure relief valves
- Electrical phase reversal protection
- Holding charge (Dry Nitrogen)
- Copper tube, aluminum plate fin coils
- Low ambient cooling to 50°F as shipped
- Low ambient cooling to 0°F with accessory head pressure control
- Mounting/lifting rails under base
- UL listed
- **5-year compressor warranty (TWA072A, TWA090A, TWA120A, TWA180D, TWA240A)**
- **1-year limited parts warranty**
- **Optional Extended Warranties**

Model Number Description — Heat Pump Condenser

Digit 1–3 — Unit Function
TWA = Split System Heat Pump

Digit 4–6 — Tonnage

072 = 6 Tons (60Hz)

090 = 7.5 Tons (60Hz)

120 = 10 Tons (60Hz)

180 = 15 Tons (60Hz)

240 = 20 Tons (60Hz)

Digit 7 — Refrigerant

4 = R-410A

Digit 8 — Voltage

3 = 208-230VAC - 3 PH (60Hz)

4 = 460VAC - 3 PH (60Hz)

W = 575VAC - 3 PH (60Hz)

K = 380VAC - 3 PH (60Hz)

Digit 9 — Refrigeration Circuit/Stage

A = 1 Compressor/1 Line/1 Stage (Single)

D = 2 Compressors/2 Line/2 Stage (Duals)

Digit 10 — Major Design Sequence

A = Rev A

Digit 11 — Minor Design Sequence

B = Rev B

Digit 12–13 — Service Digits

00 = 00

Digit 14 — Efficiency Generation

A = Generation A

Digit 15 — Controls

R = ReliaTel™

Digit 16 — None

0 = None

Digit 17 — Coil Protection

0 = Standard Coil

1 = Standard Coil w/ Hail Guard

2 = Black Epoxy Pre-Coated Condenser Coil (FIN/TUBE)

3 = Black Epoxy Pre-Coated Condenser Coil with Hail Guard (FIN/TUBE)

Digit 18-20 — None

0 = None

Digit 21 — Communications Options

0 = No Option

2 = LonTalk® Communications Interface (LCI)

Digit 22-40 — None

0 = None

Table LSH-1-A — TWA Split System Heat Pumps — Single Compressor with Single Refrigerant Circuits — R-410 Refrigerant

Model Number	Power Supply	AHRI Net Cooling Cap. (BTUH)	Uncrated Dimensions(in.)			Shipping Weight (lbs.)	Sound ^① Rating	MCA*	Max. Fuse*	Line Size (in)	
			H	W	L					OD Gas	OD Liq.
TWA07243A	208-230/3/60	80,000	45	45	38	360	84	31	50	1 ³ / ₈	1 ¹ / ₂
TWA09043A	208-230/3/60	86,000	45	45	38	382	83	34	50	1 ³ / ₈	1 ¹ / ₂
TWA12043A	208-230/3/60	123,000	52.1	55	42	495	90	46	70	1 ³ / ₈	1 ¹ / ₂
TWA07244A	460/3/60	80,000	45	45	38	360	84	15	25	1 ³ / ₈	1 ¹ / ₂
TWA09044A	460/3/60	86,000	45	45	38	382	83	18	30	1 ³ / ₈	1 ¹ / ₂
TWA12044A	460/3/60	123,000	52.1	55	42	495	90	25	40	1 ³ / ₈	1 ¹ / ₂
TWA0724WA	575/3/60	80,000	45	45	38	360	84	11	15	1 ³ / ₈	1 ¹ / ₂
TWA0904WA	575/3/60	86,000	45	45	38	382	83	13	20	1 ³ / ₈	1 ¹ / ₂
TWA1204WA	575/3/60	123,000	52.1	55	42	495	90	22	35	1 ³ / ₈	1 ¹ / ₂

Table LSH-1-B — TWA Split System Heat Pumps — Dual Compressors with Two Sets of Refrigerant Circuits — R-410 Refrigerant

Model Number	Power Supply	AHRI Net Cooling Cap. (BTUH)	Uncrated Dimensions(in.)			Shipping Weight (lbs.)	Sound ^① Rating	MCA*	Max. Fuse*	Line Size (in)	
			H	W	L					OD Gas	OD Liq.
TWA07243D	208-230/3/60	77,000	45	55	42	413	84	27	35	7 ⁷ / ₈	1 ¹ / ₂
TWA09043D	208-230/3/60	93,000	45	55	42	466	83	33	45	1 ¹ / ₈	1 ¹ / ₂
TWA12043D	208-230/3/60	118,000	52.1	55	42	478	90	46	70	1 ¹ / ₈	1 ¹ / ₂
TWA18043D	208-230/3/60	188,000	51.1	96	48	874	93	66	90	1 ¹ / ₈	1 ¹ / ₂
TWA24043D	208-230/3/60	248,000	51.1	96	48	1003	94	86	110	1 ³ / ₈	5 ⁵ / ₈
TWA07244D	460/3/60	77,000	45	55	42	413	84	15	20	7 ⁷ / ₈	1 ¹ / ₂
TWA09044D	460/3/60	93,000	45	55	42	466	83	15	20	1 ¹ / ₈	1 ¹ / ₂
TWA12044D	460/3/60	118,000	52.1	55	42	478	90	20	25	1 ¹ / ₈	1 ¹ / ₂
TWA18044D	460/3/60	188,000	51.1	96	48	874	93	32	40	1 ¹ / ₈	1 ¹ / ₂
TWA24044D	460/3/60	248,000	51.1	96	48	1003	94	46	60	1 ³ / ₈	5 ⁵ / ₈
TWA0724WD	575/3/60	77,000	45	55	42	413	84	10	15	7 ⁷ / ₈	1 ¹ / ₂
TWA0904WD	575/3/60	93,000	45	55	42	466	83	11	15	1 ¹ / ₈	1 ¹ / ₂
TWA1204WD	575/3/60	118,000	52.1	55	42	478	90	15	20	1 ¹ / ₈	1 ¹ / ₂
TWA1804WD	575/3/60	188,000	51.1	96	48	874	93	25	30	1 ³ / ₈	1 ¹ / ₂
TWA2404WD	575/3/60	248,000	51.1	96	48	1003	94	35	45	1 ³ / ₈	5 ⁵ / ₈

① Sound rating shown is tested in accordance with ARI Standard 270 or 370.

* Information subject to change. Please confirm with current Product Data/Service Facts for current factory production.

For complete equipment / combination selections, installation instructions and warranty information, please refer to Product Data/Ratings and/or Installers Guides and Limited Warranty Handbooks.

LSH-1

Effective 1/1/20

14-1011-37

BUILT TO A HIGHER STANDARD[®]

American Standard[®]
HEATING & AIR CONDITIONING

Split System Heat Pumps Three Phase – 7½-20 Tons, R-22

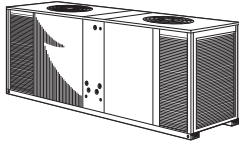
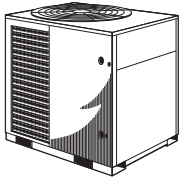

TWA – 7.5-20 Tons

- ReliaTel™ controls (standard)
- (1) Scroll compressor (TWA072-120A)
- (2) Scroll compressors (TWA180-240D) with independent refrigerant circuits
- Single point power
- Compressor motor overload protection
- Compressor discharge temperature limit switch
- Control transformer
- High and low pressure cut-out switches
- Liquid line filter drier, factory installed
- Demand Defrost Control
- Internal pressure relief valves
- Electrical phase reversal protection
- Holding charge (Dry Nitrogen)
- Copper tube, aluminum plate fin coils
- Low ambient cooling to 50°F as shipped
- Low ambient cooling to 0°F with accessory head pressure control
- Mounting/lifting rails under base
- UL listed

Model Number Description — Heat Pump Condenser

Digit 1-3 — Unit Function
TWA = Split System Heat Pump

Digit 4-6 — Tonnage
090 = 7.5 Tons (60Hz)
120 = 10 Tons (60Hz)
180 = 15 Tons (60Hz)
240 = 20 Tons (60Hz)

Digit 7 — Refrigerant
2 = R-22

Digit 8 — Voltage
3 = 208-230VAC - 3 PH (60Hz)
4 = 460VAC - 3 PH (60Hz)

Digit 9 — Refrigeration Circuit/Stage
A = 1 Compressor/1 Line/1 Stage (Single)
D = 2 Compressors/2 Line/2 Stage (Duals)

Digit 10 — Major Design Sequence
A = Rev A

Digit 11 — Minor Design Sequence
B = Rev B

Digit 12-13 — Service Digits
00 = 00

Digit 14 — Efficiency Generation
A = Generation A

Digit 15 — Controls
R = ReliaTel™

Digit 16 — None
0 = None

Digit 17 — Coil Protection
0 = Standard Coil

Digit 18-20 — None
0 = None

Digit 21 — Communications Options
0 = No Option

Digit 22-40 — None
0 = None

TableL SH-2-A — TWA Split System Heat Pumps - Single Compressors with Single Refrigerant Circuits - R-22 Refrigerant

Model Number	Power Supply	Nom. Cap. Cooling (BTUH)	Uncrated Dimensions(in.)			Shipping Weight (lbs.)	Sound ^① Rating	MCA*	Max. Fuse*	Line Size (in)	
			H	W	L					OD Gas	OD Liq.
TWA09023A	208-230/3/60	90,000	46.1	45	38	397	83	31	50	1 ³ / ₈	5 ⁵ / ₈
TWA12023A	208-230/3/60	120,000	52.1	55	42	482	90	43	70	1 ³ / ₈	1 ¹ / ₂
TWA09024A	460/3/60	90,000	46.1	45	38	397	83	15	25	1 ³ / ₈	5 ⁵ / ₈
TWA12024A	460/3/60	120,000	52.1	55	42	482	90	22	35	1 ³ / ₈	1 ¹ / ₂

Table LSH-2-B — TWA Split System Heat Pumps - Dual Compressors with Dual Refrigerant Circuits - R-22 Refrigerant

Model Number	Power Supply	Nom. Cap. Cooling (BTUH)	Uncrated Dimensions(in.)			Shipping Weight (lbs.)	Sound ^① Rating	MCA*	Max. Fuse*	Line Size (in)	
			H	W	L					OD Gas	OD Liq.
TWA18023D	208-230/3/60	180,000	51.1	96	48	920	93	60	80	1 ³ / ₈	1 ¹ / ₂
TWA24023D	208-230/3/60	240,000	51.1	96	48	1003	94	78	100	1 ³ / ₈	5 ⁵ / ₈
TWA18024D	460/3/60	180,000	51.1	96	48	920	93	30	40	1 ³ / ₈	1 ¹ / ₂
TWA24024D	460/3/60	240,000	51.1	96	48	1003	94	40	50	1 ³ / ₈	5 ⁵ / ₈

① Sound rating shown is tested in accordance with ARI Standard 270 or 370.
* Information subject to change. Please confirm with current Product Data/Service Facts for current factory production.

Light Commercial Split System Heat Pumps

For complete equipment / combination selections, installation instructions and warranty information, please refer to Product Data/Ratings and/or Installers Guides and Limited Warranty Handbooks.

Split System Heat Pumps – Accessories Three Phase – 6-20 Tons, R-410A

Table LSH-3-A — TWA Accessories

Model	Used With
Coil (Hail/Vandal) Guard	
BAYGARD058*	TWA072**A, TWA090**A
BAYGARD059*	TWA072**D, TWA090**D
BAYGARD060*	TWA120
BAYGARD061*	TWA180, TWA240
Rubber Isolators	
BAYISLT005* (black)	TWA072, TWA090, TWA120
BAYISLT009* (red)	TWA180
BAYISLT010* (green)	TWA240
Steel Spring Isolators	
BAYISLT023* (red)	TWA072, TWA090, TWA120
BAYISLT024* (black)	TWA180
BAYISLT025* (yellow)	TWA240
Service Valve Kit	
BAYVALV001A	TWA0724*A, TWA1204*A
BAYVALV002A	TWA0904*A
BAYVALV003A	TWA0724*D, TWA0904*D, TWA1204*D
BAYVALV006A	TWA01804*D, TWA2404*D
Low Ambient — On/Off Fan Control (External mount, small cabinets)① ② ③	
BAYLOAMU01* (External Mount, small cabinets)④	(all voltages) TWA072**A, TWA090**A
BAYLOAMU02* (Internal mount, large cabinets)	(all voltages) TWA120, TWA180, TWA240
Head Pressure Control②	
BAYLOAM335* (208–230V, 0.5 HP, Hi-Eff Motor)	TWA072*3A/D, TWA090*3A/D
BAYLOAM336* (208–230V, 1 HP, Hi-Eff Motor)	TWA120*3A/D, TWA180*3D, TWA240*3D
BAYLOAM435*(380-460V, 0.5HP Hi-Eff Motor)	TWA072*4A/D, TWA090*4A/D
BAYLOAM436*(380-460V, 1 HP Hi-Eff Motor)	TWA120*4A/D, TWA180*4D, TWA240*4D
BAYLOAMW36* (575V, 1 HP, Hi-Eff Motor)	TWA120*WA/D, TWA180*WD, TWA240*WD
Transducer Kit for Head Pressure Control (BAYLOAM335, 336, 435, 436, W36)	
BAYLOTR001*⑤	TWA072**D, TWA090**D, TWA120**D
Trane Communication (3/4 Communications Interface)⑥	
BAYICSI003*	All Models
LonTalk Communications Interface⑥	
BAYLTCI002*	All Models

① Cycles fan on/off (no modulating).

② Quantity of 1 required for each fan (2 total for ton and larger).

③ ReliaTel™ requires onboard EDC function to be disabled when BAYLOAM is used, remove OA sensor from terminal J8-1&2

④ Kit mounts external to the outdoor unit and operates by sensing ambient and liquid line temperatures.

⑤ BAYLOTR001 required when modulating BAYLOAM kits used with units that have 2 compressors (dual circuit) and 1 condenser fan.

⑥ BAYWRKT003 must also be installed when using BAYICSI003 or the BAYLTCI002 on the 15-20T Split System Heat Pump units

BUILT TO A HIGHER STANDARD[®]

American Standard[®]
HEATING & AIR CONDITIONING

Split System Heat Pumps Three Phase – 6-20 Tons

Table LSC-4-A — ReliaTel™ Control Options

Model Number	Description	Used With
ASYSTAT107A	Zone Sensor, Set Point Adj, Fan, System, EH, LED	TWA072-TWA240 with ReliaTel™ Controls
ASYSTAT109A	Zone Sensor, 2 Set Point Adj, Fan, System, EH, LED	TWA072-TWA240 with ReliaTel™ Controls
ASYSTAT777A	Digital Programmable Zone Sensor with Night Setback	TWA072-TWA240, TTA073-TTA240 with ReliaTel™ Controls
BAYSENS050 ^①	Wireless Zone Sensor	TWA072-TWA240 with ReliaTel™ Controls
BAYSENS073A	Room Sensor w/ Override and Cancel Button	TWA072-TWA240 with ReliaTel™ Controls
BAYSENS074A	Room Sensor w/ Temperature Adjustment and Override Button	TWA072-TWA240 with ReliaTel™ Controls
BAYSENS077A	Remote Sensor	ASYSTAT107A, ASYSTAT109A, ASYSTAT777A
BAYSENS110A	Dual Set Point w/ Manual/Auto Change Over	TWA072-TWA240 with ReliaTel™ Controls

Table LSC-4-B — Electromechanical Control Options

Model Number	Description	Used With
ASYSTAT092A	2H/2C Touch Screen Digital Display Programmable Thermostat "Touch Screen"	All
ASYSTAT093A	3H/2C Digital Display Programmable Thermostat W/Humidity Sensor	All

^① Kit comes with everything required for installation and operation.

6 - 20 Tons with ReliaTel™ Controls

Protection/Operation Timings and Features

Anti Short Cycle Timer (ASCT) Function — Provides a three (3) minute minimum “ON” time and a three (3) minute minimum “OFF” time for compressors, enhances compressor reliability by ensuring proper oil return. **Standard**

Built In Fan Delay Relay (FDR) Function — Provides custom indoor fan timing sequences for the different types of equipment, enhancing efficiency and reliability. **Standard**

Built In Night Set Back and Unoccupied Functions^① — When using a standard dual setpoint/auto change over Zone Sensor Module (ZSM), this function is enabled by applying a short across terminal J6-11 and J6-12. Sets cooling setpoint up a minimum of 7°F, sets heating setpoint back a minimum of 7°F, and forces fan operation to automatic. **(requires time clock accessory or field supplied/installed switch or contacts).**

Built In “TEST” Mode — Aids in quick verification of system and control operation, exercises both hardware and software (no special tools required). **Standard**

Built In Unoccupied Mode^① — When using a standard single setpoint/manual change over Zone Sensor Module (ZSM), this function is enabled by applying a short across terminal J6-11 and J6-12. Forces fan operation to automatic. **(requires time clock accessory or field supplied/installed switch or contacts.)**

Direct Digital Control (DDC)^① — Proportional Integral (PI) control. Proportional – sets corrective action proportional to deviation from setpoint. Integral – fine tunes the rate of corrective action proportional to the error (results in superior space temperature control). **Standard**

Increased Reliability — Fewer components (moving electro-mechanical parts), less likelihood of equipment down time or failure. **Standard**

Integral Electric Heat Staging^① — Stages electric heaters “OFF” and “ON”, eliminating the use of outdated sequencers. **Standard**

Intelligent Fallback^① — A built in Default Control provides adaptive operation, which allows the equipment to continue to operate, providing comfort in the event of certain component failures. Also, allows emergency operation without a Zone Sensor Module (ZSM). **Standard**

Low Ambient Start Timer (LAST) Function — Bypasses low pressure control when a compressor starts, eliminating nuisance compressor lock outs. **Standard**

Lower Installation Cost — Using a standard Zone Sensor Module (ZSM), control voltage wiring may be run up to five (5) times further than any electromechanical system, with no increase in wire gauge. Example: Electromechanical System – 30 feet maximum using 22 gauge wire. Micro Control System – 150 feet using 22 gauge wire. **Standard**

On Board Diagnostics^① — Assist with equipment troubleshooting, if a problem occurrence should take place. **Standard**

Remote Sensing^① — All standard Zone Sensor Modules (ZSMs) have remote sensing capabilities, typically achieved by using an expensive program-mable thermostat and remote sensor with electromechanical equipment. **Accessory (requires use of remote sensor).**

Space Temperature Averaging^① — All standard Zone Sensor Modules (ZSMs) have space temperature averaging capabilities, typically achieved by using an expensive programmable thermostat and minimum of four (4) remote sensors with electromechanical equipment. **Averaging with ReliaTel™ can be achieved with two (2) sensors.**

Time Delay Relay (TDR) Function — Provides an incremental staging delay between compressors, minimizes equipment current inrush and consumption by keeping compressors from starting simultaneously. **Standard**

Low Pressure and High Pressure Compressor Lockout — 3 trips will lockout control.

When the ReliaTel™ RTRM Thermostat Interface is used, equipment operation differs significantly. The basic equipment protection features remain intact, and the following features and benefits are lost:

- Direct Digital Control (DDC) – Proportional Integral (PI) control is lost, equipment is controlled by a thermostat or generic building automation system device.
- Intelligent Fall back is lost, if a failure occurs in the device controlling the equipment, operation will cease.
- Installation is more costly, with the addition of a thermostat or generic control, the control wiring size must be increased.
- Remote Sensing capabilities are lost, unless generic control being applied can accomplish this.
- Space Temperature Averaging capabilities are lost, unless generic control being applied can accomplish this.
- Built In Night Set Back and Unoccupied functions are lost, unless generic control being applied can accomplish this.
- Built In Unoccupied Mode is lost, unless generic control being applied can accomplish this.

Demand Defrost — Defrosts only if needed, not based on time like most other systems, optimizing and lowering operating costs.

^① Denotes features lost from utilizing standard conventional stat.

Split System Air Handlers, R-410A

Single Phase – 5-10 Tons

Three Phase – 5-25 Tons

- Ships in horizontal configuration, but quickly and easily converts to upflow
- Expansion valve factory installed
- Check valves for heat pump applications
- Belt drive blower
- Factory installed motor, belt, sheaves, contactor, low voltage terminal board
- One inch filters on 5 to 10 ton units (rack convertible for field supplied two inch)
- Captive screws remain on the panels for service ease

- Low voltage terminal board
- Drain Pan
- Factory Installed (EDC) Evaporator Defrost Control
- IAQ (Indoor Air Quality) sloped/free draining pan, no standing water
- Two inch filters factory installed on 12½, 15, 20, 25 ton units
- Supplemental heaters (electric, water, steam) fits directly on unit discharge for low installation cost

- Single point power entry for reduced electrical power installation cost
- Unit fully assembled to reduce field installation costs
- Compact design with low service clearance to reduce building requirements
- Brazed refrigerant piping connections
- Fan relay UL listed and CSA Certified
- **Optional extended warranties**

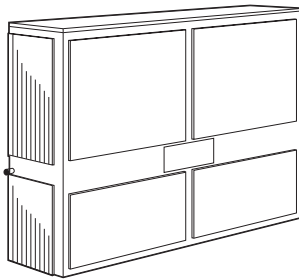

5, 7½, 10, 12½, 15, 20, 25 Ton TWE Convertible Air Handlers (Upflow or Horizontal Only)

1 2 3 456 7 8 9 10 11 12
 T W E 180 D 3 R 3 A A

Capacity

061 = 5 Tons 180 = 15 Tons
 090 = 7.5 Tons 240 = 20 Tons
 120 = 10 Tons 300 = 25 Tons
 150 = 12.5 Tons

Factory-Installed Options

- 00 = Standard Motor - Electromechanical Controls
- 03 = 2 speed VFD Standard Motor - Electromechanical Controls
- 04 = 2 speed VFD Oversized Motor - Electromechanical Controls
- R3 = SZVAV VFD Standard Motor - ReliaTel™ Controls
- R4 = SZVAV VFD Oversized Motor - ReliaTel™ Controls

Table LAH-1-A — Single Circuit Coil - R-410A^⑤

Tons	Unit Model No.	Power Supply Volts/Phase/Hz	Capacity (Btuh)	FCCV	Drive Type	Dimensions (in.) ^④ H x W x D	Shipping Weight (lbs.)	MCA*	Max Fuse Size or Max Circuit Breaker ^③ *
Single Phase									
5	TWE061D100AA	208-230/1/60	60,000	TXV	Belt	48 x 39 x 23	263	7.5	15
7½	TWE090D100AA ^①	208-230/1/60	90,000	TXV	Belt	54 x 49 x 26	360	8.5	15
10	TWE120D100AA ^①	208-230/1/60	120,000	TXV	Belt	54 x 65 x 26	429	10.6	15
Three Phase									
5	TWE061D300AA	208-230/3/60	60,000	TXV	Belt	48 x 39 x 23	263	3.1	15
5	TWE061D400AA	460/3/60	60,000	TXV	Belt	48 x 39 x 23	263	1.6	15
5	TWE061DW00AA	575/3/60	60,000	TXV	Belt	48 x 39 x 23	263	1.6	15
7½	TWE090D300AA ^{①②}	208-230/3/60	90,000	TXV	Belt	54 x 49 x 26	360	6.6	15
7½	TWE090DW00AA ^①	575/3/60	90,000	TXV	Belt	54 x 49 x 26	360	2.3	15
10	TWE120D300AA ^{①②}	208-230/3/60	120,000	TXV	Belt	54 x 65 x 26	429	7.8	15
10	TWE120DW00AA ^①	575/3/60	120,000	TXV	Belt	54 x 65 x 26	429	2.9	15

^① Control transformer not included. Order control transformer accessory when matching these air handlers with 3-5 ton condensing units.

^② Ships wired for 208-230/3/60. Field convertible to 460/3/60.

^③ HACR type circuit breaker per NEC.

^④ Dimensions based on Upflow position.

^⑤ All air handlers are shipped with the drain pan installed in the horizontal position. For vertical configuration, the drain pan should be repositioned before setting the air handler.

* Information subject to change. Please confirm with current Product Data/Service Facts for current factory production.

BUILT TO A HIGHER STANDARD™

American Standard
HEATING & AIR CONDITIONING

Split System Air Handlers, R-410A

Single Phase – 5-10 Tons

Three Phase – 5-25 Tons

- Ships in horizontal configuration, but quickly and easily converts to upflow
- Expansion valve factory installed
- Check valves for heat pump applications
- Belt drive blower
- Factory installed motor, belt, sheaves, contactor, low voltage terminal board
- One inch filters on 5 to 10 ton units (rack convertible for field supplied two inch)
- Captive screws remain on the panels for service ease
- Low voltage terminal board
- Drain Pan

- Factory Installed (EDC) Evaporator Defrost Control
- IAQ (Indoor Air Quality) sloped/free draining pan, no standing water
- Two inch filters factory installed on 12½, 15, 20, 25 ton units
- Supplemental heaters (electric, water, steam) fits directly on unit discharge for low installation cost
- Single point power entry for reduced electrical power installation cost
- Unit fully assembled to reduce field installation costs

- Compact design with low service clearance to reduce building requirements
- Brazed refrigerant piping connections
- Fan relay UL listed and CSA Certified
- Factory installed 2 speed variable frequency drive (VFD) option available for enhanced part load performance and minimum REQUIRED for CA Title 24 Compliance®
- Factory installed Single Zone VAV (SZVAV) option available for enhanced part load performance and space temperature control via varying airflow®
- **Optional extended warranties**

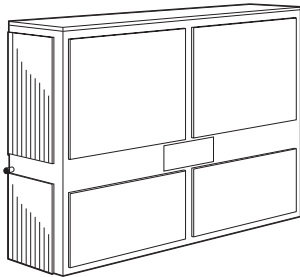

5, 7½, 10, 12½, 15, 20, 25 Ton TWE Convertible Air Handlers (Upflow or Horizontal Only)

1 2 3 456 7 8 9 10 11 12
T W E 180 D 3 R 3 A A

Capacity

061 = 5 Tons 180 = 15 Tons
090 = 7.5 Tons 240 = 20 Tons
120 = 10 Tons 300 = 25 Tons
150 = 12.5 Tons

Factory-Installed Options

- 00 = Standard Motor - Electromechanical Controls
- 03 = 2 speed VFD Standard Motor - Electromechanical Controls
- 04 = 2 speed VFD Oversized Motor - Electromechanical Controls
- R3 = SZVAV VFD Standard Motor - ReliaTel™ Controls
- R4 = SZVAV VFD Oversized Motor - ReliaTel™ Controls

Table LAH-2-A — Dual Circuit Coil — R-410A

Tons	Unit Model No.	Power Supply Volts/Phase/Hz	Capacity (Btuh)	FCCV	Drive Type	Dimensions (in.) ^④ H x W x D	Shipping Weight (lbs.)	MCA*	Max Fuse Size or Max Circuit Breaker ^③ *
Single Phase									
5	TWE061E100AA	208-230/1/60	60,000	TXV	Belt	48 x 39 x 23	263	7.5	15
7½	TWE090E100AA ^①	208-230/1/60	90,000	TXV	Belt	54 x 49 x 26	360	8.5	15
10	TWE120E100AA ^①	208-230/1/60	120,000	TXV	Belt	54 x 65 x 26	429	10.6	15
Three Phase									
5	TWE061E300AA	208-230/3/60	60,000	TXV	Belt	48 x 39 x 23	263	3.1	15
5	TWE061E400AA	460/3/60	60,000	TXV	Belt	48 x 39 x 23	263	1.6	15
6	TWE073E300AA ^②	208-230/3/60	72,000	TXV	Belt	54 x 49 x 26	385	6.6	15
6	TWE073EW00AA	575/3/60	72,000	TXV	Belt	54 x 49 x 26	385	2.3	15
7½	TWE090E300AA ^{①②}	208-230/3/60	90,000	TXV	Belt	54 x 49 x 26	360	6.6	15
10	TWE120E300AA ^{①②}	208-230/3/60	120,000	TXV	Belt	54 x 65 x 26	429	7.8	15
10	TWE120EW00AA ^①	575/3/60	120,000	TXV	Belt	54 x 65 x 26	429	2.9	15
12 ½	TWE150E300AA ^②	208-230/3/60	150,000	TXV	Belt	69 x 81 x 30	730	7.4	15
12 ½	TWE150EW00AA	575/3/60	150,000	TXV	Belt	69 x 81 x 30	730	2.8	15
15	TWE180E300AA ^②	208-230/3/60	180,000	TXV	Belt	69 x 81 x 30	729	11.8	20
15	TWE180EW00AA	575/3/60	180,000	TXV	Belt	69 x 81 x 30	729	4.3	15
20	TWE240E300BA	208-230/3/60	246,000	TXV	Belt	72 x 94 x 32	891	18.1	25
20	TWE240E400BA	460/3/60	246,000	TXV	Belt	72 x 94 x 32	891	8.4	15
20	TWE240EW00BA	575/3/60	246,000	TXV	Belt	72 x 94 x 32	891	6.5	15
25	TWE300E300A	208-230/3/60	292,000	TXV	Belt	72 x 94 x 32	972	24.5	30
25	TWE300E400A	460/3/60	292,000	TXV	Belt	72 x 94 x 32	972	11.2	20
25	TWE300EW00A	575/3/60	292,000	TXV	Belt	72 x 94 x 32	972	8.9	15

① Control transformer not included. Order control transformer accessory when matching these air handlers with 3-5 ton condensing units.
 ② Ships wired for 208-230/3/60. Field convertible to 460/3/60.
 ③ HACR type circuit breaker per NEC.
 ④ Dimensions based on Upflow position.
 ⑤ All air handlers are shipped with the drain pan installed in the horizontal position. For vertical configuration, the drain pan should be repositioned before setting the air handler.
 ⑥ 460V motors (digit 8=4) are only available on TWE150E and TWE180 when Title 24 or SZVAV is selected in digits 9 and 10.
 * Information subject to change. Please confirm with current Product Data/Service Facts for current factory production.

For complete equipment / combination selections, installation instructions and warranty information, please refer to Product Data/Ratings and/or Installers Guides and Limited Warranty Handbooks.

Split System Air Handlers, R-410A

Single Phase – 5-10 Tons
 Three Phase – 5-25 Tons

Table LAH-3-A — 6 - 10 Ton Electric Heater Selection

Model Number	Description	Used With
BAYHTRL106A	4.33/5.76 kW Heater 208/240/1 Phase	TWE061D1-TWE120E1
BAYHTRL112A	8.65/11.52 kW Heater 208/240/1 Phase	TWE061D1-TWE120E1
BAYHTRL117A	12.98/17.28 kW Heater 208/240/1 Phase	TWE061D1-TWE120E1
BAYHTRL123A	17.30/23.04 kW Heater 208/240/1 Phase	TWE061D1-TWE120E1
BAYHTRL129A	21.65/28.80 kW Heater 208/240/1 Phase	TWE061D1-TWE120E1
BAYHTRL305A	3.75/5.00 kW Heater 208/240/3 Phase	TWE061D3-TWE120E3
BAYHTRL310A	7.45/9.96 kW Heater 208/240/3 Phase	TWE061D3-TWE120E3
BAYHTRL315A	11.25/14.96 kW Heater 208/240/3 Phase	TWE061D3-TWE120E3
BAYHTRL325A	18.71/24.92 kW Heater 208/240/3 Phase	TWE061D3-TWE120E3
BAYHTRL335A	26.20/34.88 kW Heater 208/240/3 Phase	TWE061D3-TWE120E3
BAYHTRL405A	5.00 kW Heater 460/3 Phase	TWE061D4-TWE120E3 ^①
BAYHTRL410A	9.96 kW Heater 460/3 Phase	TWE061D4-TWE120E3 ^①
BAYHTRL415A	14.96 kW Heater 460/3 Phase	TWE061D4-TWE120E3 ^①
BAYHTRL425A	24.92 kW Heater 460/3 Phase	TWE061D4-TWE120E3 ^①
BAYHTRL435A	34.88 kW Heater 460/3 Phase	TWE061D4-TWE120E3 ^①
BAYHTRLW05A	5 kW Heater 575/3 Phase	TWE061DW-TWE120EW
BAYHTRLW10A	9.96 kW Heater 575/3 Phase	TWE061DW-TWE120EW
BAYHTRLW15A	14.96 kW Heater 575/3 Phase	TWE061DW-TWE120EW
BAYHTRLW25A	24.92 kW Heater 575/3 Phase	TWE061DW-TWE120EW
BAYHTRLW35A	34.88 kW Heater 575/3 Phase	TWE061DW-TWE120EW

Table LAH-3-B — 12½ - 20 Ton Electric Heater Selection

Model Number	Description	Used With
BAYHTRM310A	7.50/10.0 kW Heater 208/230 3 Phase	TWE150E3-TWE300E3
BAYHTRM320A	14.96/19.92 kW Heater 208/230 3 Phase	TWE150E3-TWE300E3
BAYHTRM330A	22.50/29.92 kW Heater 208/230 3 Phase	TWE150E3-TWE300E3
BAYHTRM350A	37.42/49.84 kW Heater 208/230 3 Phase	TWE150E3-TWE300E3
BAYHTRM410A	10.0 kW Heater 460/3 Phase	TWE150E3 ^① -TWE300E4
BAYHTRM420A	19.92 kW Heater 460/3 Phase	TWE150E3 ^① -TWE300E4
BAYHTRM430A	29.92 kW Heater 460/3 Phase	TWE150E3 ^① -TWE300E4
BAYHTRM450A	49.84 kW Heater 460/3 Phase	TWE150EW-TWE300EW
BAYHTRMW10A	10.0 kW Heater 575/3 Phase	TWE150EW-TWE300EW
BAYHTRMW20A	19.92 kW Heater 575/3 Phase	TWE150EW-TWE300EW
BAYHTRMW30A	29.92 kW Heater 575/3 Phase	TWE150EW-TWE300EW
BAYHTRMW50A	49.84 kW Heater 575/3 Phase	TWE150EW-TWE300EW

^① Field convertible to 460/3/60.

BUILT TO A HIGHER STANDARD[®]

American Standard[®]

HEATING & AIR CONDITIONING

Split System Air Handlers, R-410A

Single Phase – 5-10 Tons

Three Phase – 5-25 Tons

Table LAH-4-A — 5 – 20 Ton Accessory Selection

Model Number	Description	Used With
Subbase		
BAYBASE009A	Vertical Air Handler Subbase	TWE061D, TWE061E
BAYBASE010A	Vertical Air Handler Subbase	TWE090D, TWE090E, TWE073E
BAYBASE011A	Vertical Air Handler Subbase	TWE120D, TWE120E
BAYBASE012A	Vertical Air Handler Subbase	TWE150E, TWE180E
BAYBASE013A	Vertical Air Handler Subbase	TWE240E, TWE300E
Grille		
BAYGRLE001A	Return Air Grille	TWE061D/E
BAYGRLE002A	Return Air Grille	TWE090D/E, TWE073E
BAYGRLE003A	Return Air Grille	TWE120D/E
BAYGRLE004A	Return Air Grille	TWE150E, TWE180E
BAYGRLE005A	Return Air Grille	TWE240E, TWE300E
High Static Motor		
BAYHSMT104B	1.5HP (230/1) w/ 1VL44 motor sheave w/ AK54 fan sheave w/ A44 belt	TWE061D1/E1
BAYHSMT105B	1.5HP (230-460/3) w/ 1VL44 motor sheave w/ AK54 fan sheave w/ A44 belt	TWE061D3-4/E3-4
BAYHSMT106B	1.5HP (575/3) w/ 1VL44 motor sheave w/ AK54 fan sheave w/ A44 belt	TWE061DW/EW
BAYHSMT107B	2 HP (230/1) w/ 1VL44 motor sheave w/ AK66 fan sheave w/ A50 belt	TWE090D1/E1
BAYHSMT108B	2 HP (230/460/3) w/ 1VL44 motor sheave w/ AK66 fan sheave w/ A50 belt	TWE090D3/E3, TWE073E3
BAYHSMT109B	2 HP (575/3) w/ 1VL44 motor sheave w/ AK66 fan sheave w/ A50 belt	TWE090DW/EW, TWE073EW
BAYHSMT110B	3 HP (230/460/3) w/ 1VP44 motor sheave w/ AK54 fan sheave w/ AX48 belt	TWE090D3/E3, TWE073E3
BAYHSMT111B	3 HP (575/3) w/ 1VP44 motor sheave w/ AK54 fan sheave w/ AX48 belt	TWE090DW/EW, TWE073EW
BAYHSMT112B	3 HP (230/460/3) w/ 1VP44L motor sheave w/ AK74 fan sheave w/ A51 belt	TWE120D3/E3
BAYHSMT113B	3 HP (575/3) w/ 1VP44L motor sheave w/ AK74 fan sheave w/ A51 belt	TWE120DW/EW
BAYHSMT114B	3 HP (230/460/3) w/ 1VP44L motor sheave w/ BK72 fan sheave w/ A51 belt	TWE150E3
BAYHSMT115B	3 HP (575/3) w/ 1VP44L motor sheave w/ BK72 fan sheave w/ A51 belt	TWE150EW
BAYHSMT116B	5 HP (230/3) w/ 1VP50L motor sheave w/ BK72 fan sheave w/ BX55 belt	TWE150E3
BAYHSMT117B	5 HP (460/3) w/ 1VP50L motor sheave w/ BK72 fan sheave w/ BX55 belt	TWE150E4
BAYHSMT118B	5 HP (575/3) w/ 1VP50L motor sheave w/ BK72 fan sheave w/ BX55 belt	TWE150EW
BAYHSMT119B	5 HP (230/3) w/ 1VP50L motor sheave w/ BK85 fan sheave w/ BX58 belt	TWE180E3
BAYHSMT120B	5 HP (460/3) w/ 1VP50L motor sheave w/ BK85 fan sheave w/ BX58 belt	TWE180E4
BAYHSMT121B	5 HP (575/3) w/ 1VP50L motor sheave w/ BK85 fan sheave w/ BX58 belt	TWE180EW
BAYHSMT122B	7.5 HP (230/460/3) w/ 1VP60 motor sheave w/ BK90 fan sheave w/ BX60 belt	TWE240E3/4
BAYHSMT123B	7.5 HP (575/3) w/ 1VP60 motor sheave w/ BK90 fan sheave w/ BX60 belt	TWE240EW
Isolators		
BAYISLT004A ^{①②③④}	Rubber Isolator Floor (blue)	TWE061D-TWE120E
BAYISLT009A ^{①②③}	Rubber Isolator Floor (red)	TWE150E, TWE180E
BAYISLT010A ^{①②③}	Rubber Isolator Floor (green)	TWE240E, TWE300E
BAYISLT012B ^③	Rubber Isolator Suspended (red/green)	TWE150E, TWE180E
BAYISLT013B ^{③④}	Rubber Suspended (red/green)	TWE061D/E
BAYISLT014A ^{③④}	Rubber Suspended (green)	TWE090D/E
BAYISLT015B ^{③④}	Rubber Suspended (green/black)	TWE120D/E
BAYISLT016B ^③	Rubber Suspended (red/green)	TWE240E, TWE300E
BAYISLT019A ^{①②③}	Steel Spring Isolator Floor (red)	TWE061D/E, TWE073E, TWE090D/E, TWE120D/E
BAYISLT021A ^{①②③}	Steel Spring Isolator Floor (black)	TWE150E, TWE180E
BAYISLT032A ^{①②③}	Steel Spring Isolator Floor (black/yellow)	TWE240E
BAYISLT028A ^③	Steel Spring Isolator Suspended (tan)	TWE061D/E
BAYISLT029A ^③	Steel Spring Isolator Suspended (red)	TWE073E, TWE090D/E, TWE120D/E
BAYISLT030A ^③	Steel Spring Isolator Suspended (black)	TWE150E, TWE180E
BAYISLT031B ^③	Steel Spring Isolator Suspended (black/yellow)	TWE240E, TWE300E
Low Static Drive Kit		
BAYLSMT001A	Low Static Drive Kit	TWE240E

① When the Air handler is in the vertical position and close proximity trapping of condensate is required, use of subbase is required.

② Requires use of subbase accessory.

③ Units having steam of hot water coils applied vertically or horizontally check IOM for proper Isolator kit selection.

④ Do not use if blower will operate less than 600 RPM.

Split System Air Handlers, R-410A

Single Phase – 5-10 Tons
 Three Phase – 5-25 Tons

Table LAH-5-A — 5 – 20 Ton Accessory Selection

Model Number	Description	Used With
Plenum		
BAYPLNM015B ^②	Discharge Plenum & Grille	TWE061D/E
BAYPLNM016B ^②	Discharge Plenum & Grille	TWE090D/E, TWE073E
BAYPLNM017B ^②	Discharge Plenum & Grille	TWE120D/E
BAYPLNM018B ^②	Discharge Plenum/Hydronic Coil Plenum & Grille	TWE150E, TWE180E
BAYPLNM019B ^②	Discharge Plenum/Hydronic Coil Plenum & Grille	TWE240E, TWE300E
BAYPLNM020B ^②	Hydronic Coil Discharge Plenum & Grille	TWE061D/E
BAYPLNM021B ^②	Hydronic Coil Discharge Plenum & Grille	TWE090D/E, TWE073E
BAYPLNM022B ^②	Hydronic Coil Discharge Plenum & Grille	TWE120D/E
BAYPLNM030A ^②	Electric Heat Discharge Plenum & Grille	TWE061D/E
BAYPLNM031A ^②	Electric Heat Discharge Plenum & Grille	TWE090D/E, TWE073E
BAYPLNM032A ^②	Electric Heat Discharge Plenum & Grille	TWE120D/E
BAYPLNM033A ^②	Electric Heat Discharge Plenum & Grille	TWE150E, TWE180E
BAYPLNM034A ^②	Electric Heat Discharge Plenum & Grille	TWE240E, TWE300E
Transformer		
BAYTFMR011A ^①	75va transformer (230V)	TWE090D3, TWE090E3, TWE120D3, TWE120E3, TWE073E3
BAYTFMR012A ^①	75va transformer	TWE090D4/W, TWE090E4/W, TWE120D4/W, TWE120E4/W, TWE073EW
BAYTFMR013A ^①		TWE090DK, TWE090EK, TWE120DK, TWE120EK
Water Kits		
BAYWATR022A ^②	Steam Coil Enclosure	TWE061D/E
BAYWATR023A ^②		TWE090D/E, TWE073E
BAYWATR024A ^②		TWE120D/E
BAYWATR025A ^②		TWE150E, TWE180E
BAYWATR026A ^②		TWE240E, TWE300E
BAYWATR027A ^②	Hot Water Coil Enclosure	TWE061D/E
BAYWATR028A ^②		TWE090D/E, TWE073E
BAYWATR029A ^②		TWE120D/E
BAYWATR030A ^②		TWE150E, TWE180E
BAYWATR031A ^②		TWE240E, TWE300E
Wire Kit		
BAYWRKT002A ^③	180 Blower Discharge Reversal Kit	TWE061D-TWE120E

① Required when 6 -10 Ton Air Handlers are matched with 3-5 Ton condensing units.

② When installed horizontally, plenum/water coil must be self supported.

③ Cannot be used on TWE150-240, due to motor mount location.

BUILT TO A HIGHER STANDARD™

American Standard
HEATING & AIR CONDITIONING

Split System Air Handlers 5-25 Tons

Factory Supplied Accessories

- (A) Air Handler (TWE 5 – 20 Tons)
- (B) Outdoor Condensing Unit (TTA – Cooling 6 – 25 Tons)
(TWA – Heat Pump 6 – 20 Tons)
- (P) Discharge Plenum and Grille (BAYPLNM)
- (EH) Electric Heater and Casing (BAYHTRL)
Fits on Top of Unit (13 H x 30 W x 17 D)
- (SB) Subbase (BAYBASE)
- (I) Isolators (BAYISLT)
- (RG) Return Grille (BAYGRLE)
- (CG) Coil Guards (BAYLOAM)
- (WC) Steam/Hot Water Coil (BAYWATR)

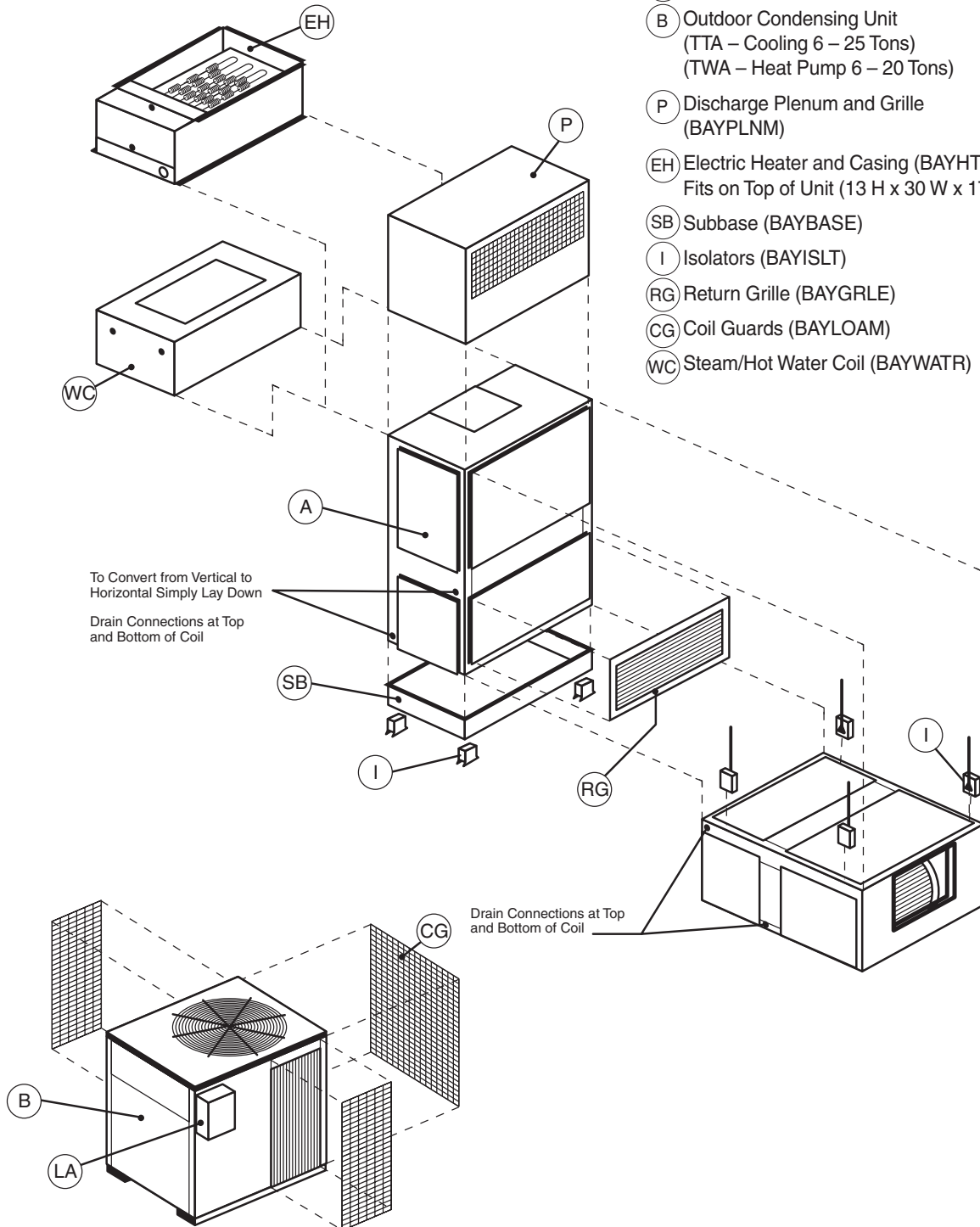

For complete equipment / combination selections, installation instructions and warranty information, please refer to Product Data/Ratings and/or Installers Guides and Limited Warranty Handbooks.



ASYSSTAT095A

Non-Programmable Comfort Controls for ReliaTel™ Units

ASYSSTAT095A

- One-touch temperature control.
- Large, clear, backlit display is easy to read, even in the dark.
- Displays both room temperature and temperature setting.
- Removable battery holder for fast, easy replacement.
- Built-in compressor protection.
- **Focus Pro 3 Heat/ 2 Cool**

BASED OUT

Programmable Comfort Controls for ReliaTel™ Units



ASYSSTAT090A

ASYSSTAT090A

- Large, Clear Display with Backlighting — Current temperature, set temperature and time are easy-to-read and all are displayed on the main screen.
- Menu Driven Programming — Provides guidance through the scheduling process, showing only necessary information and choices on each screen.
- Ability to Select Multiple Days — Allows easy customizing for unique schedules.
- Real-Time Clock—Keeps time during power failure; automatically updates for daylight saving time.
- Armchair Programming — Can remove thermostat from wall to set the schedule.
- Precise Temperature Control (± 1 °F) — reliable, consistent comfort.
- Multiple OVERRIDE options — Can modify schedule for a specific period of time (up to 365 days).
- Outdoor Temperature Indication — Displays current outdoor temperature to help plan outdoor activities.
- **2 Heat/2 Cool**

SE

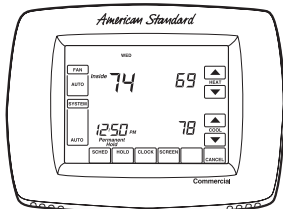

ASYSSTAT092A

ASYSSTAT092A

- Large, Clear Display with Backlighting — Current temperature, set temperature and time are easy-to-read and all are displayed on the main screen.
- Menu Driven Programming — Provides guidance through the scheduling process, showing only necessary information and choices on each screen.
- Ability to Select Multiple Days — Allows easy customizing for unique schedules.
- Real-Time Clock — Keeps time during power failure; automatically updates for daylight savings.
- Armchair Programming — Can remove thermostat from wall to set the schedule. Precise Temperature Control (± 1 °F) — reliable, consistent comfort.
- Multiple OVERRIDE options — Can modify schedule indefinitely or for a specific period of time.
- Programmable Fan — Increases indoor air quality when combined with air cleaning equipment.
- Outdoor Temperature Indication — Displays current outdoor temperature to help plan outdoor activities.
- **2 Heat/2 Cool Commercial Vision Pro**

SE

BUILT TO A HIGHER STANDARD[®]

American Standard[®]
HEATING & AIR CONDITIONING

Programmable Comfort Controls for ReliaTel[™] Units

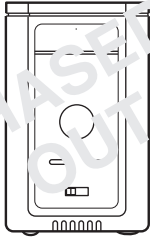

ASYSTAT800A

ASYSTAT800A

- Wall mounted remote space sensor
- For use with ASYSTAT090A, ASYSTAT092A, and ASYSTAT093A programmable thermostats

Light Commercial
Comfort Controls/Zone Sensors

Zone Sensor Unit Installation

The zone sensor provides the operator control and zone temperature sensing functions for use with electronic unit controls. Refer to the appropriate unit installation manual for interconnecting wiring instructions.

ZONE SENSOR LOCATION

To ensure proper operation, select a location on an interior wall, at a height approximately 5 feet above the floor, with freely circulating air of average temperature.

Avoid Locations:

- Behind doors or in corners where air does not freely circulate.
- On an outside wall or any wall with unheated (uncooled) areas behind the zone sensor.
- Where direct sunlight or any Source: of radiant heat could affect the temperature measurements.
- In line with the discharge air from the unit being controlled.

Mount the zone sensor base on the wall or optional mounting plate with the wires routed through the wire access hole in the base of the zone sensor.

ZONE SENSOR CONTROLS

Emergency Heat/Heat/Auto/Off/Cool

This switch determines whether the unit operates in emergency heat (EM. HEAT - for heat pumps only), heating (HEAT), automatically changing from heating to cooling as required (AUTO), heating and cooling functions disabled (OFF), or cooling (COOL).

Fan Auto/Fan On

This switch determines whether the indoor fan operates during cooling and heating cycles only (FAN AUTO) or runs continuously (FAN ON).

Temperature Adjustments

One or two temperature adjustment controls are provided to set the desired temperature or temperature range (for unit mode AUTO). If two controls are present, the blue control sets the desired temperature for cooling and the red control sets the desired temperature for heating.

Temperature Indicator

This indicates the temperature in the zone. The indicator has been factory calibrated and should not normally require adjustment. If adjustment is needed, it can be accomplished by slowly rotating a small screwdriver in the slot on the back of the indicator until the correct temperature is obtained.

Optional Remote Sensor

When using the optional remote sensor (BAYSENS077A), it should be located in the space that is to be controlled. Wire according to the interconnecting wiring diagrams in the unit IOM.

Installation: 18-HD60D41

Source: Clarksville

BUILT TO A HIGHER STANDARD[®]

American Standard[®]
HEATING & AIR CONDITIONING

Micro Control Zone Sensors

Light Commercial
Comfort Controls/Zone Sensors



ASYSSTAT106A
Manual Changeover

- 4 wires required.
- Single Setpoint for 3-25 Tons Electric/Electric and Gas/Electric Systems
- Can be used with Remote Sensor (ASYSSTAT669)



ASYSSTAT107A
Manual Changeover

- 4-6 wires required.
- Single Setpoint for W- Heat Pump Systems (3-20 Tons)
- Can be used with Remote Sensor (ASYSSTAT669)



ASYSSTAT108A
Automatic Changeover

- 5 wires required.
- Dual Setpoint for Electric/Electric and Gas Electric Systems (3-25 Tons)
- Can be used with Remote Sensor (ASYSSTAT669)



ASYSSTAT109A
Automatic Changeover

- 5-7 wires required.
- Dual Setpoint for W- Heat Pump Systems (3-20 Tons)
- Can be used with Remote Sensor (ASYSSTAT669)



ASYSSTAT709A/707A
LCD Digital Display Zone Sensor

- 3-7 wires required.
- Non-Programmable Zone Sensor with a digital display
- ASYSSTAT709A - Cool/Gas
- ASYSSTAT707A - Heat Pumps

Zone Sensors must be used with Micro Control units. Vendor Thermostats which use Triac outputs are not recommended with Micro Control units. Major features lost by using a Conventional Thermostat include the following:

- No diagnostics
- Proportional Integral control
- No smart recovery in the heating mode (heat pumps)
- 2-stage electric heat (heat pumps)
- Stand alone set up and set back for unoccupied features
- Intelligent fall back (unit can run on default value with outdoor air sensor)
- Control wiring size may be increased
- Remote sensing capability
- Space temperature averaging
- Supply air tempering
- Economizer preferred cooling is lost (compressor operation is locked out below 50°F)

For complete equipment / combination selections, installation instructions and warranty information, please refer to Product Data/Ratings and/or Installers Guides and Limited Warranty Handbooks.

BUILT TO A HIGHER STANDARD

American Standard
HEATING & AIR CONDITIONING



Electronic Programmable Zone Sensors For ReliaTel™ Units

ASYSSTAT777A

- **Automatic or Manual Changeover with System Lights**
- Use With:
 - 3 – 10 Ton Precedent™ Units
 - 12.5 – 25 Ton Voyager™ Units
- Digital display indicating the time of day, the day of the week, room temperature, current program operating mode, and current active stage
- Continuous or 3 hour timed override
- Two occupied, two unoccupied programs per day
- L.C.D. readout in F or C (Celsius) and 12 or 24-hour clock
- Keyboard disable to prevent tampering
- Programming on a 7-day basis
- Status indication lights displayed in Digital Display
- Auxiliary relay (Form 1C)
- Auto Fan During Setback
- No Anticipator Required
- No Battery Required
- No accessories required. Each unit is complete and ready for installation
- Remote Room Sensor (ASYSSTAT669)
- Finish: Pantone Cool Gray #2C
- Replacement: SEN-0415
- Installation: 18-HD60D29
- Source: Clarksville

Integrated Comfort™ Systems Sensors For ReliaTel™ Units



ASYSSTAT669

- **Room Sensor**
- Used with Integrated Comfort™ Systems
- Used With:
 - 3 - 10 Ton Precedent™ Units
 - 12.5 - 25 Ton Voyager™ Units
- Finish: Pantone Cool Gray #2C
- Replacement: SEN01448
- Installation: Included with sensor
- Source: St. Paul GCC/Clarksville

Light Commercial
Comfort Controls/Zone Sensors

BUILT TO A HIGHER STANDARD™

American Standard[®]
HEATING & AIR CONDITIONING



Beveled Top
Smoother Design
Small compact cabinet
Recessed access handles

Packaged Cooling Convertible 3-10 Tons

Standard Features:

- American Standard Heating & Air Conditioning scroll compressors on all 3-10 ton units
- Colored and numbered wiring
- Phase Monitor, R-410A 3 Phase Units
- Provisions for through the Base Condensate Drain Connections
- Crankcase Heaters
- 2" throwaway filters provided on all ton units
- Liquid Line Refrigerant Drier
- Operating Charge of R-410A
- IAQ Sloped Drain Pans
- Single point power for Electric Heat
- Low Ambient to 40°F on Electromechanical models
- Low Ambient to 0°F on ReliaTel™ models
- 5 - year Limited Compressor Warranty
- 1 - year Limited Parts Warranty

Added Flexibility

- Electromechanical or ReliaTel™ controls (**See page LPC-12 for ReliaTel™ Control Information**)
- Standard or high efficiency cooling models available. 17+ available in 3-5T. For reference to 17+ please refer to publications RT-PRC048-EN and RT-SLB020-EN
- Convertible airflow (ships in downflow application)
- Fork lift openings on three sides of unit
- Direct or belt drive - standard or oversized motors (Direct for 3-5 ton only)
- We don't prepackage options
- Choose options tailored to suit each job —pay only for what is needed
- Units ship with options installed —and within our standard ship cycle time

Factory Installed Options

- Through-the-Base — Electrical
- Convenience Outlet — Powered or unpowered
- Unit Disconnect Switch
- Smoke Detectors — Supply, return, or both
- Condenser Coil Coating
- Hinged Access Service Panels
- Discharge Air Sensor
- Fan Fail and Clogged Filter Switches
- Condenser Coil Guard — Hail Protection Quality
- Dehumidification Hot Gas Reheat Coil (High Efficiency Units Only)
- Froststat
- Comm 3/4 Communications Interface
- BACnet™ Communications Interface
- 2" Pleated Media filters
- 2" MERV 8 filters or 2" MERV 13 filters
- Multi-Speed & Single Zone VAV ID Airflow
- Demand Control Ventilation
- Stainless Steel Drainpan
- Condensate Drainpan Overflow Switch

Light Commercial
Packaged Cooling

The same American Standard Heating & Air Conditioning Quality and Reliability ... with added Flexibility!

For complete equipment / combination selections, installation instructions and warranty information, please refer to Product Data/Ratings and/or Installers Guides and Limited Warranty Handbooks.

LPC-1

Effective 1/1/20
14-1011-37

Packaged Cooling Convertible 3-5 Tons, R-410A

Table LPC-2-A — Precedent™ 17 Plus — R-410A — ReliaTel™ Controls Only

Tons	Unit Ordering No.	Performance SEER	Cooling Capacity (Btuh)	Cabinet Dimensions (in.) H x W x L	Downflow Supply	Downflow Return	Shipping Weight (lbs.)	MCA**	Max Fuse**
THC - 208-230/3/60 - Three Phase - No Heat									
3	THC037E3R0A0000	17.5	36,500	36 x 44 x 69	18 x 15.5	24 x 14	614	24	30
4	THC047E3R0A0000	17.5	50,500	41 x 53 x 88	33 x 17.5	32 x 17.5	787	30	40
5	THC067E3R0A0000	17.2	60,000	41 x 53 x 88	33 x 17.5	32 x 17.5	841	33	45
THC - 460/3/60 - Three Phase - No Heat									
3	THC037E4R0A0000	17.5	36,500	36 x 44 x 69	18 x 15.5	24 x 14	614	13	15
4	THC047E4R0A0000	17.5	50,500	41 x 53 x 88	33 x 17.5	32 x 17.5	787	14	15
5	THC067E4R0A0000	17.2	60,000	41 x 53 x 88	33 x 17.5	32 x 17.5	841	15	20

Table LPC-2-B — Base Unit — 15 SEER High Efficiency — R-410A — Electromechanical or ReliaTel™

Tons	Unit Ordering No.	Performance ^② SEER	Cooling Capacity (Btuh)	Cabinet Dimensions (in.) H x W x L	Downflow Supply	Downflow Return	Shipping Weight (lbs.)	MCA**	Max ^① Fuse**
THC - 208-230/1/60 - Single Phase - No Heat									
3	THC036E1*0A0000	15.2	38,490	36 x 44 x 69	18 x 15.5	24 x 14	555	28	45
4	THC048E1*0A0000	15.0	48,930	41 x 53 x 88	33 x 17.5	32 x 17.5	798	37	50
5	THC060E1*0A0000	15.0	61,000	41 x 53 x 88	33 x 17.5	32 x 17.5	823	41	60
THC - 208/3/60 - Three Phase - No Heat									
3	THC036E3*0A0000	15.0	37,600	36 x 44 x 69	18 x 15.5	24 x 14	555	21	30
4	THC048E3*0A0000	15.0	49,930	41 x 53 x 88	33 x 17.5	32 x 17.5	637	26	35
5	THC060E3*0A0000	15.0	61,000	41 x 53 x 88	33 x 17.5	32 x 17.5	869	30	45
THC - 460/3/60 - Three Phase - No Heat									
3	THC036E4*0A0000	15.0	37,600	36 x 44 x 69	18 x 15.5	24 x 14	555	12	15
4	THC048E4*0A0000	15.0	49,930	41 x 53 x 88	33 x 17.5	32 x 17.5	637	13	15
5	THC060E4*0A0000	15.0	61,000	41 x 53 x 88	33 x 17.5	32 x 17.5	869	14	20

Table LPC-2-C — Base Unit— 14 SEER— R-410A— Electromechanical or ReliaTel™

Tons	Unit Ordering No.	Performance SEER	Cooling Capacity (Btuh)	Cabinet Dimensions (in.) H x W x L	Downflow Supply	Downflow Return	Shipping Weight (lbs.)	MCA**	Max Fuse**
TSC - 208-230/3/60 - Three Phase - No Heat									
3	TSC036G3*0A0000	14.0	37,000	41 x 44 x 69	18 x 15.5	24 x 14	537	20	30
4	TSC048G3*0A0000	14.0	49,000	41 x 44 x 69	18 x 15.5	24 x 14	557	26	35
5	TSC060G3*0A0000	14.0	60,000	41 x 44 x 69	18 x 15.5	24 x 14	603	40	40
TSC - 460/3/60 - Three Phase - No Heat									
3	TSC036G4*0A0000	14.0	37,000	41 x 44 x 69	18 x 15.5	24 x 14	537	10	15
4	TSC048G4*0A0000	14.0	49,000	41 x 44 x 69	18 x 15.5	24 x 14	557	11	15
5	TSC060G4*0A0000	14.0	60,000	41 x 44 x 69	18 x 15.5	24 x 14	603	13	15
TSC - 575/3/60 - Three Phase - No Heat									
3	TSC036GW*0A0000	14.0	37,000	41 x 44 x 69	18 x 15.5	24 x 14	537	8	15
4	TSC048GW*0A0000	14.0	49,000	41 x 44 x 69	18 x 15.5	24 x 14	557	24	25
5	TSC060GW*0A0000	14.0	60,000	41 x 44 x 69	18 x 15.5	24 x 14	603	10	15

① HACR breaker per NEC.

② SEER applies, 3-5 tons; EER applies 6-10 tons.

* Digit 9 - E = Electromechanical or R = ReliaTel™.

** Information subject to change. Please confirm with current Product Data/Service Facts for current factory production.

Light Commercial
Packaged Cooling

BUILT TO A HIGHER STANDARD

American Standard
HEATING & AIR CONDITIONING

Packaged Cooling Convertible 6-10 Tons, R-410A

Table LPC-3-A — Base Unit — High Efficiency — R-410A — Electromechanical or ReliaTel™

Tons	Unit Ordering No.	Performance EER	Cooling Capacity (Btuh)	Cabinet Dimensions (in.) H x W x L	Downflow Supply	Downflow Return	Shipping Weight (lbs.)	MCA**	Max [Ⓞ] Fuse**
THC – 208-230/3/60 – Three Phase High Efficiency									
6	THC072F3*0A0000	14.5	72,000	47 x 53 x 88	33 x 17.5	32 x 17.5	997	31	45
6	THC074F3*0A0000	15.5	73,000	47 x 53 x 88	33 x 17.5	32 x 17.5	1016	37	50
7½	THC092F3*0A0000	14.5	92,000	47 x 53 x 88	33 x 17.5	32 x 17.5	1124	42	50
8½	THC102F3*0A0000	14.7	104,000	47 x 53 x 88	33 x 17.5	32 x 17.5	1124	42	50
10	THC120F3*0A0000	14.7	116,000	51 x 63 x 100	33 x 17.5	32 x 17.5	1326	48	60
THC – 460/3/60 – Three Phase									
6	THC072F4*0A0000	14.5	72,000	47 x 53 x 88	33 x 17.5	32 x 17.5	997	15	20
6	THC074F4*0A0000	15.5	73,000	47 x 53 x 88	33 x 17.5	32 x 17.5	1016	18	20
7½	THC092F4*0A0000	14.5	92,000	47 x 53 x 88	33 x 17.5	32 x 17.5	1124	20	25
8½	THC102F4*0A0000	14.7	104,000	47 x 53 x 88	33 x 17.5	32 x 17.5	1124	20	25
10	THC120F4*0A0000	14.7	116,000	51 x 63 x 100	33 x 17.5	32 x 17.5	1326	22	25

Table LPC-3-B — Base Unit — Standard Efficiency — R-410A — Electromechanical or ReliaTel™

Tons	Unit Ordering No.	Performance SEER/EER	Cooling Capacity (Btuh)	Cabinet Dimensions (in.) H x W x L	Downflow Supply	Downflow Return	Shipping Weight (lbs.)	MCA**	Max Fuse**
TSC – 208-230/3/60 – Three Phase – No Heat									
6	TSC072H3*0A0000	12.9	75,000	41 x 53 x 88	33 x 17.5	32.13 x 17.5	898	35	50
7½	TSC090H3*0A0000	12.9	92,500	41 x 53 x 88	33 x 17.5	32.13 x 17.5	815	38	60
7½	TSC092H3*0A0000	12.9	94,800	47 x 53 x 88	33 x 17.5	32.13 x 17.5	1009	39	50
8½	TSC102H3*0A0000	12.9	107,200	47 x 53 x 88	33 x 17.5	32.13 x 17.5	1048	44	50
10	TSC120H3*0A0000	12.9	116,000	47 x 53 x 88	33 x 17.5	32.13 x 17.5	1058	49	60
TSC – 460/3/60 – Three Phase – No Heat									
6	TSC072H4*0A0000	12.9	75,000	41 x 53 x 88	33 x 17.5	32.13 x 17.5	898	17	25
7½	TSC090H4*0A0000	12.9	92,500	41 x 53 x 88	33 x 17.5	32.13 x 17.5	815	19	30
7½	TSC092H4*0A0000	12.9	94,800	47 x 53 x 88	33 x 17.5	32.13 x 17.5	1009	18	20
8½	TSC102H4*0A0000	12.9	107,200	47 x 53 x 88	33 x 17.5	32.13 x 17.5	1048	21	25
10	TSC120H4*0A0000	12.9	116,000	47 x 53 x 88	33 x 17.5	32.13 x 17.5	1058	22	25
TSC – 575/3/60 – Three Phase – No Heat									
6	TSC072HW*0A0000	12.9	75,000	41 x 53 x 88	33 x 17.5	32.13 x 17.5	898	13	20
7½	TSC090HW*0A0000	12.9	92,500	41 x 53 x 88	33 x 17.5	32.13 x 17.5	815	15	20
7½	TSC092HW*0A0000	12.9	94,800	47 x 53 x 88	33 x 17.5	32.13 x 17.5	1009	15	20
8½	TSC102HW*0A0000	12.9	107,200	47 x 53 x 88	33 x 17.5	32.13 x 17.5	1048	16	20
10	TSC120HW*0A0000	12.9	116,000	47 x 53 x 88	33 x 17.5	32.13 x 17.5	1058	22	25

Ⓞ HACR breaker per NEC.

* Digit 9-E=Electromechanical or R=ReliaTel™.

** Information subject to change. Please confirm with current Product Data/Service Facts for current factory production.

Light Commercial
Packaged Cooling

For complete equipment / combination selections, installation instructions and warranty information, please refer to Product Data/Ratings and/or Installers Guides and Limited Warranty Handbooks.

BUILT TO A HIGHER STANDARD[®]

American Standard[®]
HEATING & AIR CONDITIONING

Packaged Cooling Convertible 3-10 Tons (Model Digit Numbers)

Digit	Description	Order Number	Digit	Description	Order Number
1-8	Main Assembly (see previous page)		21	Communications Options^②	
9	Unit Controls			No Communications Interface	0
	Electro-Mechanical	E		Comm 3/4 Communications Interface	1
	ReliaTel™ Micro-processor	R		BACnet™ Communications Interface	6
10	(See Heater Table below)		22	Refrigeration System Option	
11	Minor Design Sequence			Standard Refrigeration System	0
	First Sequence	A		Dehumidification (Hot Gas Reheat Coil) ^{②⑦}	B
12-13	Service Sequence		23	Refrigeration Controls	
	First Sequence (Factory Supplied)	*,*		Note: Applicable to Digit 7 = E,F	
14	Fresh Air Selection			No Refrigeration Control	0
	No Fresh Air	0		Frostat ^④	1
	0-50% Manual Outside Air Damper ^⑩	A		Crankcase Heater	2
	0-50% Motorized Outside Air Damper	B		Frostat and Crankcase Heater	3
	0-100% Economizer, Dry Bulb without Barometric Relief ^②	C	24	Smoke Detector^{③②}	
	0-100% Economizer, Dry Bulb with Barometric Relief ^②	D		No Smoke Detector	0
	0-100% Economizer, Reference Enthalpy without Barometric Relief ^{①②}	E		Return Air Smoke Detector ^{⑥⑦}	A
	0-100% Economizer, Reference Enthalpy with Barometric Relief ^{①②}	F		Supply Air Smoke Detector	B
	0-100% Economizer, Comparative Enthalpy without Barometric Relief ^{①②}	G		Supply and Return Air Smoke Detectors ^{⑥⑦}	C
	0-100% Economizer, Comparative Enthalpy with Barometric Relief ^{①②}	H		Plenum Smoke Detector	D
	Low Leak Economizer, Dry Bulb with Barometric Relief	K	25	Monitoring Controls^②	
	Low Leak Economizer, Comparative Enthalpy with Barometric Relief	M		No Monitoring Control ^③	0
	Low Leak Economizer, Reference Enthalpy with Barometric Relief	P		Clogged Filter Switch ^③	1
15	Supply Fan/Drive Type/Motor			Fan Failure Switch ^③	2
	Standard Drive	0		Discharge Air Sensing Tube ^③	3
	Oversized Motor	1		Clogged Filter Switch and Fan Fail Switch ^③	4
	Optional Belt Drive Motor (3 phase only)	2		Clogged Filter Switch and Discharge Air Sensing Tube ^③	5
	Single Zone VAV	6		Fan Fail Switch and Discharge Air Sensing Tube ^③	6
	Multi-Speed Indoor Fan	7		Clogged Filter and Fan Fail Switches and Discharge Air Sensing Tube ^③	7
	VAV Supply Air Temperature Control Standard Motor ..	E		Condensate Drain Pan Overflow Switch	A
16	Hinged Service Access & Filters			Clogged Filter Switch ^③ and Condensate Drain Pan Overflow Switch	B
	Standard Panels & Filters	0		Fan Failure Switch ^③ and Condensate Drain Pan Overflow Switch	C
	Hinged Access Panels & Standard Filters	A		Discharge Air Sensing ^③ and Condensate Drain Pan Overflow Switch	D
	Standard Panels & 2" Pleated Filters MERV 8	B		Clogged Filter Switch ^③ , Fan Failure Switch ^③ and Condensate Drain Pan Overflow Switch	E
	Hinged Access Panels & 2" Pleated Filters MERV 8	C		Clogged Filter Switch ^③ , Discharge Air Sensing Tube ^③ and Condensate Drain Overflow Switch	F
	Standard Panels/2" MERV 13 Filters	D		Fan Failure Switch, Discharge Air Sensing Tube ^③ and Condensate Drain Pan Overflow Switch	G
	Hinged Access Panels/2" MERV 13 Filters	E		Clogged Filter Switch ^③ , Fan Failure Switch ^③ , Discharge Air Sensing ^③ and Condensate Drain Pan Overflow Switch	H
17	Condenser Coil Protection		26	System Monitoring Controls	
	Standard Coil	0		No Monitoring Controls	0
	Standard Coil with Hail Guard	1		Demand Control Ventilation (CO ₂) ^{④⑤}	A
	Black Epoxy Pre-Coated Condenser Coil	2	27	Unit Hardware Enhancements	
	Black Epoxy Pre-Coated Condenser Coil with Hail Guard	3		No Enhancements	0
	Complete Coat™ Condenser Coil	4		Stainless Steel Drain Pan	1
	Complete Coat™ Condenser Coil with Hail Guard	5		Fault Detection and Diagnostics (FDD)	B
18	Through the Base Provisions			Fault Detection and Diagnostics (FDD) with Demand Control Ventilation	C
	No Through the Base Provisions	0	31	Advanced Unit Controls	
	Through the Base Electric ^⑩	A		Standard Unit Controls	0
19	Disconnect/Circuit Breaker /Phase Monitor (3 phase only)			Human Interface	1
	No Disconnect/ Circuit Breaker	0			
	Unit Mounted Non-Fused Disconnect ^⑩	1			
	Unit Mounted Circuit Breaker ^⑩	2			
20	Convenience Outlet				
	No Convenience Outlet	0			
	Unpowered Convenience Outlet	A			
	Powered Convenience Outlet (3 phase only) ^③	B			

① Enthalpy control not available factory installed with electro-mechanical controls.
 ② Economizer with Barometric Relief is for downflow configured units only. Order Economizer without Barometric Relief for horizontal configuration. Barometric relief for horizontal configured units must be ordered as field installed accessory BAYBARM010A.
 ③ Requires use of Disconnect or Circuit Breaker.
 ④ Frostat cannot be field installed in electro-mechanical units.
 ⑤ Not available with BAYFRST001A High Temperature Stat accessory.
 ⑥ The return air smoke detector may not fit up or work properly on the Convertible units when used in conjunction with 3rd party accessories such as bolt on heat wheels, economizers and power exhaust. Do not order the return air smoke detectors when using this type of accessory.
 ⑦ Return Air Smoke Detector cannot be ordered with Novar Controls.
 ⑧ These options are standard when ordering Novar Controls.
 ⑨ This options for use when ordering Novar Control only.
 ⑩ The manual outside air damper will ship factory supplied within the unit, but must be field installed.
 ⑪ Through the base electric required when ordering disconnect/circuit breaker options.
 ⑫ Not available with electro-mechanical unit controls.
 ⑬ Novar Sensor utilized with digit 21 = (4) Novar 3051 Controls without Zone Sensor.
 ⑭ Available for T/Y 10 ton standard efficiency models only.

⑮ Available for T/Y 3, 4, 5, 6, 7½, 8½ ton standard/high efficiency models only.
 ⑯ Requires selection of 2" Pleated Filters (option B or C) for Digit 16.
 ⑰ Not available on 6 ton units and all single phase or standard efficiency.
 ⑱ Standard on T/YSC 6, 7½ (single and dual systems), 8½, 10 ton standard efficiency models and T/YHC 4, 5, 6, 7½ ton high efficiency models (except for dehumidification models).
 ⑲ Epoxy coil and epoxy with hailguard options are not available for units with microchannel condenser coil.
 ⑳ Single Zone VAV is only available on 7.5-10 ton high efficiency and 10 ton standard efficiency products with ReliaTel™ controls.
 ㉑ Multi-speed indoor fan available only on 7.5 & 8.5 ton high efficiency, and 10 ton products with ReliaTel™ controls.
 ㉒ Motorized Outside Air Damper is not available on Multi-Speed or SZVAV (Single Zone Variable Air Volume) products.
 ㉓ Frostat standard on Multi-Speed and SZVAV (Single Zone Variable Air Volume) products.
 ㉔ Novar is not available with SZVAV products.
 ㉕ Demand Control Ventilation not available with electromechanical controls.
 ㉖ Demand Control Ventilation Option includes wiring only. The CO₂ sensor is a field-installed only option.
 ㉗ When ordering Dehumidification option, Digit #7 will revert back to E, not F.

Light Commercial
Packaged Cooling

For complete equipment / combination selections, installation instructions and warranty information, please refer to Product Data/Ratings and/or Installers Guides and Limited Warranty Handbooks.

Packaged Cooling Convertible 3-10 Tons (Model Digit Numbers)

Heaters (Digit 10)

kW Rating	Digit	Nominal BTUH	No. Stages	Used With	kW Rating	Digit	Nominal BTUH	No. Stages	Used With
208/240/1/60					460/3/60				
3.7/5.0	(A)	12,800/17,100	1	T*C036-060*1	6.0	(B)	20,500	1	T*C036-060*4
7.5/10.0	(D)	25,600/34,100	2	T*C036-060*1	12.0	(E)	41,000	2	T*C036-060*4
10.3/13.8	(F)	35,300/47,100	2	T*C036-060*1	17.6	(G)	59,400	2	T*C036-060*4
13.2/17.6	(G)	45,100/60,100	2	T*C048-060*1	23.0	(J)	78,500	2	T*C060*4
208/240/3/60					575/3/60				
4.5/6.0	(B)	13,400/20,500	1	T*C036-060*3	9.0	(C)	30,700	1	T*C072-102*4
9.0/12.0	(E)	30,800/59,400	2	T*C036-060*3	18.0	(G)	61,400	1	T*C072-120*4
13.2/17.6	(G)	44,600/59,400	2	T*C036-060*3	27.0	(K)	92,100	2	T*C072-120*4
17.2/23.0	(J)	58,900/78,500	2	T*C060*3	36.0	(N)	122,900	2	T*C072-120*4
6.75/9.0	(C)	23,000/30,700	1	T*C072-102*3	54.0	(P)	184,300	2	T*C120*4
13.5/18.0	(G)	46,100/61,400	1	T*C072-120*3					
20.3/27.0	(K)	69,000/92,100	2	T*C072-120*3	6.0	(B)	20,500	1	T*C036-060*W
27.0/36.0	(N)	92,200/122,900	2	T*C072-120*3	12.0	(E)	41,000	2	T*C036-060*W
40.5/54.0	(P)	138,200/184,300	2	T*C120*3	17.6	(G)	59,400	2	T*C036-060*W
					23.0	(J)	78,500	2	T*C060*W
					9.0	(C)	30,700	1	T*C072-102*W
					18.0	(G)	61,400	1	T*C072-120*W
					27.0	(K)	92,100	2	T*C072-120*W
					36.0	(N)	122,900	2	T*C072-120*W
					54.0	(P)	184,300	2	T*C120*W

Digit 15 Selection Details

Digit 15 = 0

Standard Efficiency

3 Phase (3 to 5 Ton) = Multispeed Direct Drive Motor

3 Phase (6 to 8.5 Ton) = Belt Drive

3 Phase (10 Ton) = Ultra High Efficiency Direct Drive Plenum Fan

High Efficiency

1 Phase = High Efficiency Multispeed Direct Drive Motor

3 Phase (3 to 5 ton) = High Efficiency Multispeed Direct Drive Motor

3 Phase (3 to 5 ton w/Dehumidification) = Belt Drive Motor

3 Phase [6 (074) to 10 ton] = Ultra High Efficiency Direct Drive Plenum Fan

Digit 15 = 2

Standard Efficiency

3 Phase = Not Available

High Efficiency

1 Phase = Not Available

BUILT TO A HIGHER STANDARD[®]

American Standard[®]
HEATING & AIR CONDITIONING

Packaged Cooling Convertible 3-5 Tons, R-410A Electric Heaters

Table LPC-6-A — Accessory Electric Heaters – Unit with Heater is single circuit / single point power entry (3-5 Ton units)

Model Number	Power Supply	kW Rating	Nominal BTUH	No. Stages	Used With
BAYHTRE105A	208-230/1/60	3.8/5.0	12,900/13,400	1	THC036E1
BAYHTRE110A	208-230/1/60	7.5/10.0	25,600/34,000	2	THC036E1
BAYHTRE114A	208-230/1/60	10.4/13.8	35,000/47,100	2	THC036E1
BAYHTRE306C	208-230/3/60	4.5/6.0	13,400/20,500	1	THC036E3 THC037E3, TSC036G-060G3
BAYHTRE312C	208-230/3/60	9.0/12.0	30,800/41,000	2	THC036E3 THC037E3, TSC036G-060G3
BAYHTRE318C	208-230/3/60	13.0/17.4	44,600/59,400	2	THC036E3 THC037E3, TSC036G-060G3
BAYHTRE323C	208-230/3/60	17.3/23.0	44,600/59,400	2	TSC060G3
BAYHTRE406C	460/3/60	6	20500	1	THC036E4 THC037E4, TSC036G-060G4
BAYHTRE412C	460/3/60	12	41000	2	THC036E4 THC037E4, TSC036G-060G4
BAYHTRE418C	460/3/60	17.4	59400	2	THC036E4 THC037E4, TSC036G-060G4
BAYHTRE423C	460/3/60	17.3/23.0	59400	2	TSC060G4
BAYHTREW06C	575/3/60	6	20500	1	TSC036G-060GW
BAYHTREW12C	575/3/60	12	41000	2	TSC036G-060GW
BAYHTREW18C	575/3/60	17.4	59400	2	TSC036G-060GW
BAYHTREW23C	575/3/60	17.3/23.0	59400	2	TSC060GW
BAYHTRX105A	208-230/1/60	3.8/5.0	12,900/13,400	1	THC048-060F1
BAYHTRX110A	208-230/1/60	7.5/10.0	25,600/34,000	2	THC048-060F1
BAYHTRX114A	208-230/1/60	10.4/13.8	35,000/47,100	2	THC048-060F1
BAYHTRX306B	208-230/1/60	4.5/6.0	13,400/20,500	1	THC047-067E3, THC048-060E3, THC048-048F3
BAYHTRX312B	208-230/3/60	9.0/12.0	30,800/41,000	2	THC047-067E3, THC048-060E3, THC048-048F3
BAYHTRX318B	208-230/3/60	13.0/17.4	44,600/59,400	2	THC047-067E3, THC048-060E3, THC048-048F3
BAYHTRX323B	208-230/3/60	17.3/23.0	59,000/78,500	2	THC067E3, THC060E3, THC060F3
BAYHTRX406B	460/3/60	6	20500	1	THC047-067E4, THC048-060E4, THC048-048F4
BAYHTRX412B	460/3/60	12	41000	2	THC047-067E4, THC048-060E4, THC048-048F4
BAYHTRX418B	460/3/60	18	59400	2	THC047-067E4, THC048-060E4, THC048-048F4
BAYHTRX423B	460/3/60	23	78500	2	THC067E4, THC060E4, THC060F4

Light Commercial
Packaged Cooling

For complete equipment / combination selections, installation instructions and warranty information, please refer to Product Data/Ratings and/or Installers Guides and Limited Warranty Handbooks.

LPC-6

Effective 1/1/20
14-1011-37

Packaged Cooling Convertible 6-10 Tons, R-410A Electric Heaters

**Table LPC-7-A — Accessory Electric Heaters – Unit with Heater is single circuit / single point power entry
 (6-8 1/2 Ton Standard Efficiency units)**

Model Number	Power Supply	kW Rating	Nominal BTUH	No. Stages	Used With
BAYHTRS309B	208-230/3/60	6.75/9.0	23,000/30,700	1	TSC072F3, TSC072H3
BAYHTRS318B	208-230/3/60	13.5/18.0	46,100/61,400	2	TSC072F3, TSC072H3
BAYHTRS327B	208-230/3/60	20.3/27.0	69,000/92,100	2	TSC072F3, TSC072H3
BAYHTRS336B	208-230/3/60	27.0/36.0	92,200/122,900	2	TSC072F3, TSC072H3
BAYHTRS409B	460/3/60	9	30700	1	TSC072F4, TSC072H4
BAYHTRS418B	460/3/60	18	61400	2	TSC072F4, TSC072H4
BAYHTRS427B	460/3/60	27	92100	2	TSC072F4, TSC072H4
BAYHTRS436B	460/3/60	36	122900	2	TSC072F4, TSC072H4
BAYHTRSW09B	575/3/60	9	30700	1	TSC072FW, TSC072HW
BAYHTRSW18B	575/3/60	18	61400	2	TSC072FW, TSC072HW
BAYHTRSW27B	575/3/60	27	92100	2	TSC072FW, TSC072HW
BAYHTRSW36B	575/3/60	36	122900	2	TSC072FW, TSC072HW
BAYHTRW309A	208-230/3/60	6.75/9.0	23,000/30,700	1	TSC090F3, TSC090H3
BAYHTRW318A	208-230/3/60	13.5/18.0	46,100/61,400	1	TSC090F3, TSC090H3
BAYHTRW327A	208-230/3/60	20.3/27.0	69,000/92,100	2	TSC090F3, TSC090H3
BAYHTRW336A	208-230/3/60	27.0/36.0	92,200/122,900	2	TSC090F3, TSC090H3
BAYHTRW409A	460/3/60	9	30700	1	TSC090F4, TSC090H4
BAYHTRW418A	460/3/60	18	61400	1	TSC090F4, TSC090H4
BAYHTRW427A	460/3/60	27	92100	2	TSC090F4, TSC090H4
BAYHTRW436A	460/3/60	36	122900	2	TSC090F4, TSC090H4
BAYHTRWW09A	575/3/60	9	30700	1	TSC090FW, TSC090HW
BAYHTRWW18A	575/3/60	18	61400	1	TSC090FW, TSC090HW
BAYHTRWW27A	575/3/60	27	92100	2	TSC090FW, TSC090HW
BAYHTRWW36A	575/3/60	36	122900	2	TSC090FW, TSC090HW
BAYHTRT309B	208-230/3/60	6.75/9.0	23,000/30,700	1	TSC092F3, TSC092H3, TSC102F3, TSC102H3
BAYHTRT318B	208-230/3/60	13.5/18.0	46,100/61,400	2	TSC092F3, TSC092H3, TSC102F3, TSC102H3
BAYHTRT327B	208-230/3/60	20.3/27.0	69,000/92,100	2	TSC092F3, TSC092H3, TSC102F3, TSC102H3
BAYHTRT336B	208-230/3/60	27.0/36.0	92,200/122,900	2	TSC092F3, TSC092H3, TSC102F3, TSC102H3
BAYHTRT409B	460/3/60	9	30700	1	TSC092F4, TSC092H4, TSC102F4, TSC102H4
BAYHTRT418B	460/3/60	18	61400	2	TSC092F4, TSC092H4, TSC102F4, TSC102H4
BAYHTRT427B	460/3/60	27	92100	2	TSC092F4, TSC092H4, TSC102F4, TSC102H4
BAYHTRT436B	460/3/60	36	122900	2	TSC092F4, TSC092H4, TSC102F4, TSC102H4
BAYHTRTW09B	575/3/60	9	30700	1	TSC092FW, TSC092HW, TSC102FW, TSC102HW
BAYHTRTW18B	575/3/60	18	61400	2	TSC092FW, TSC092HW, TSC102FW, TSC102HW
BAYHTRTW27B	575/3/60	27	92100	2	TSC092FW, TSC092HW, TSC102FW, TSC102HW
BAYHTRTW36B	575/3/60	36	122900	2	TSC092FW, TSC092HW, TSC102FW, TSC102HW

BUILT TO A HIGHER STANDARD[®]

American Standard[®]
HEATING & AIR CONDITIONING

Packaged Cooling Convertible 6-10 Tons, R-410A Electric Heaters

**Table LPC-8-A — Accessory Electric Heaters – Unit with Heater is single circuit / single point power entry
(6 - 8 1/2 Ton High Efficiency, 10 Ton Units)**

Model Number	Power Supply	kW Rating	Nominal BTUH	No. Stages	Used With
BAYHTRA309A	208-230/3/60	9	30700	1	THC074-102F3
BAYHTRA318A	208-230/3/60	13.5/18	46,100/61,400	1	THC074F3
BAYHTRA327A	208-230/3/60	20.3/27	69,000/92,100	2	TSC120F3, TSC120H3, THC074-102F3
BAYHTRA336A	208-230/3/60	27/36	92,200/122,900	2	THC074F3
BAYHTRA354A	208-230/3/60	40.5/54	138,200/184,300	2	TSC120F3, TSC120H3
BAYHTRA409A	460/3/60	9	30700	1	THC074F-THC102F
BAYHTRA418A	460/3/60	18	61400	1	TSC120F4, TSC120H4, THC074-102F4
BAYHTRA427A	460/3/60	27	92100	2	TSC120F4, TSC120H4, THC074-102F4
BAYHTRA436A	460/3/60	36	122900	2	TSC120F4, TSC120H4, THC074-102F4
BAYHTRA454A	460/3/60	54	184300	2	TSC120F4, TSC120H4
BAYHTRAW18A	575/3/60	18	61400	1	TSC120FW, TSC120HW
BAYHTRAW36A	575/3/60	36	122900	2	TSC120FW, TSC120HW
BAYHTRAW54A	575/3/60	54	184300	2	TSC120FW, TSC120HW
BAYHTRD318A	208-230/3/60	13.5/18.0	46,100/61,400	1	THC120F3
BAYHTRD327A	208-230/3/60	20.3/27.0	69,000/92,100	2	THC120F3
BAYHTRD336A	208-230/3/60	27.0/36.0	92,100/122,900	2	THC120F3
BAYHTRD354A	208-230/3/60	40.6/54.0	138,000/184,300	2	THC120F3
BAYHTRD418A	460/3/60	18	61400	1	THC120F4
BAYHTRD427A	460/3/60	27	92100	2	THC120F4
BAYHTRD436A	460/3/60	36	122900	2	THC120F4
BAYHTRD454A	460/3/60	54	184300	2	THC120F4
BAYHTRZ318A	208-230/3/60	13.5/18.0	46,100/61,400	1	TSC092H3, TSC102H3, TSC120F3, TSC120H3, THC092-102F3
BAYHTRZ336A	208-230/3/60	20.3/27.0	69,000/92,100	2	TSC092H3, TSC102H3, TSC120F3, TSC120H3, THC092-102F4
BAYHTRZ337A	208-230/3/60	27.0/36.0	92,100/122,900	2	THC120F3
BAYHTRZ354A	208-230/3/60	40.6/54.0	138,000/184,300	2	THC120F3
BAYHTRZ436A	460/3/60	36	122900	2	THC120F4
BAYHTRZ454A	460/3/60	54	184300	2	THC120F4

Light Commercial
Packaged Cooling

For complete equipment / combination selections, installation instructions and warranty information, please refer to Product Data/Ratings and/or Installers Guides and Limited Warranty Handbooks.

LPC-8

Effective 1/1/20
14-1011-37

Packaged Cooling Convertible 3-10 Tons Accessories

Table LPC-9-A — Accessories

Model Number	Description	Used With
BAYABRD001C.....	ReliaTel™ Options Module.....	All T*036-120* (ReliaTel™) See Note ⑤
BAYASCT001.....	Anti-Short-Cycle Timer.....	All T*036-120* (Electro Mechanical)
BAYBARM010A④.....	Barometric Relief	THC036-060*, THC036E
BAYBARM011A④.....	Barometric Relief	TSC072-102*, THC092F, TSC120F, THC048*-120*
BAYBCIR001A.....	Bacnet™ Communication Interface	ReliaTel™ Controller (BCI-R)
BAYCO2K001B③⑥.....	CO ₂ Sensor Kit, Wall Mounted.....	All T*036-120* (ReliaTel™)
BAYCO2K003B③⑥.....	CO ₂ Sensor Kit, Duct Mounted.....	All T*036-120* (ReliaTel™)
BAYCURB042A②.....	Roof Curb.....	TSC036-060, THC036, THC037
BAYCURB043A②.....	Roof Curb.....	TSC072-120, THC048-102
BAYCURB044A.....	Roof Curb.....	THC120
BAYDMPR053B.....	0-50% Manual Outside Air Damper	TSC036-060, THC036, THC037
BAYDMPR056B.....	0-50% Manual Outside Air Damper	TSC072-120, THC047-120
BAYDMPR051A.....	0-50% Motorized Outside Air Damper	TSC036-060, THC036, THC037 (ReliaTel™)
BAYDMPR052B.....	0-50% Motorized Outside Air Damper	TSC036-060, THC036 (Electro Mechanical)
BAYDMPR054A.....	0-50% Motorized Outside Air Damper	TSC072-120, THC047-120 (ReliaTel™)
BAYDMPR055B.....	0-50% Motorized Outside Air Damper	TSC072-120, THC047-120 (Electro Mechanical)
BAYECON085A③.....	0-100% Dry Bulb Economizer without Barometric Relief ...	TSC036-060, THC036, THC037 (ReliaTel™)
BAYECON086B⑥.....	0-100% Dry Bulb Economizer without Barometric Relief ...	TSC036-060, THC036 (Electro Mechanical)
BAYECON087A③.....	0-100% Dry Bulb Economizer without Barometric Relief ...	TSC072-120, THC047-120 (ReliaTel™)
BAYECON088B⑥.....	0-100% Dry Bulb Economizer without Barometric Relief ...	TSC072-120, THC048-120 (Electro Mechanical)
BAYECON704A.....	Downflow Low Leak Economizer	TSC072-120, THC047-120 (ReliaTel™)
BAYECON705B.....	Downflow Low Leak Economizer	TSC036-060, THC036, THC037 (ReliaTel™)
BAYENTH300A.....	Reference Enthalpy Kit (Solid State).....	BAYECON086A, 088A (Electro-Mechanical)
BAYENTH301A.....	Comparative Enthalpy Kit (Solid State)	BAYECON086A, 088A (Electro-Mechanical)
BAYENTH005A⑦.....	Reference Enthalpy Kit.....	BAYECON085A, 087A (ReliaTel™)
BAYENTH006B⑦.....	Comparative Enthalpy Kit.....	BAYECON086A, 087A (ReliaTel™)
BAYFRST003A③⑥.....	High Temperature Stat	All T*036-120E

- ① Kits contain all necessary parts to achieve desired level of enthalpy control.
- ② Lynn Haven Manufacturing has a No-Return policy for this roof curb.
- ③ For use with ReliaTel™ controlled units only.
- ④ Barometric Relief accessory installs in ductwork for horizontal configuration. For downflow configuration, installs in the unit's horizontal return duct. See Installer's Guide for complete instructions.
- ⑤ BAYABRD001C is required when ordering field installed accessories Clogged Filter Switch (BAYDFPS003A), Fan Fail Switch (BAYDFPS004A), Discharge Air Sensing Kit (BAYTUBE004A) or Evaporator Defrost Control (Frostat) (BAYLOAM020B) Ventilation Override Kit (BAYVNOR001B) unless the following options are factory installed: Frostat, Smoke Detector, Clogged Filter Switch, Fan Failure Switch, Discharge Air Sensing Kit. These factory installed options include the ReliaTel™ Options Module.
- ⑥ For use with electromechanical controlled units only.
- ⑦ Activated on Power On.
- ⑧ Field installed accessory requires economizer.
- ⑨ The manual outside air damper will ship factory supplied within the unit, but must be field installed.

Packaged Cooling Convertible 3-10 Tons Accessories

Table LPC-10-A — Accessories

Model Number	Description	Used With
BAYGARD037C.....	Condenser Coil Hail Guard	THC036, THC037
BAYGARD040C.....	Condenser Coil Hail Guard	TSC072-090, THC047-067
BAYGARD041C.....	Condenser Coil Hail Guard	TSC092-120
BAYGARD070A.....	Condenser Coil Hail Guard	THC120
BAYGARD137A.....	Condenser Coil Hail Guard	TSC036-060
BAYGARD141A.....	Condenser Coil Hail Guard	THC072-102
BAYGARD437A.....	Condenser Coil Hail Guard	WSC036-048H, WHC036H, DHC036H
BAYGARD240A.....	Condenser Coil Hail Guard	WSC060-072H, WHC048-060, DHC048-060H
BAYGARD241A.....	Condenser Coil Hail Guard	WSC090-120H, WHC074-102H, DHC074-102H
BAYGARD270A.....	Condenser Coil Hail Guard	DHC120H, WHC120H
BAYHSDR012A.....	High Static Drive Kit	THC072
BAYHSMT082A.....	2 HP Oversized Motor Kit (208-230/460V)	TSC072*3, 4
BAYHSMT083A.....	2 HP Oversized Motor Kit (575V)	TSC072*W
BAYHSMT086A.....	3 HP Oversized Motor Kit (208-230/460V)	TSC090*102*3, 4
BAYHSMT087A.....	3 HP Oversized Motor Kit (575V)	TSC090-102*W
BAYHSMT402A.....	2 HP Oversized Motor Kit	THC072*3, 4
BAYHSDR012A.....	High Static Drive Kit	TSC072
BAYICSI003A ^{③④}	Trane Communications Interface (TCI).....	All Precedents (ReliaTel™)
BAYLMSW001A0.....	Power Exhaust Limit Switch	All Precedents
BAYLOAM020B ^{①③④}	Evaporator Defrost Control (Frostat)	THC036 (ReliaTel™)
BAYLOAM120A.....	Evaporator Defrost Control (Frostat)	TSC036-060 (ReliaTel™)
BAYLSDR006B.....	Low Static Drive Kit: 3-5T High Efficiency	THC036-060
BAYLSDR009A.....	Low Static Drive Kit	TSC092-102, THC072
BAYLTCI002B.....	LonTalk® Communications Interface (LCI).....	All Precedents (ReliaTel™)
BAYPWRX026A.....	Power Exhaust (208-230/3 VAC)	TSC072-120*3, THC047-120*3
BAYPWRX027A.....	Power Exhaust (460/3 VAC)	TSC072-120*4, THC047-120*4
BAYPWRX028A.....	Power Exhaust (575/3 VAC)	TSC072-120*W, THC047-120*W
BAYPWRX070A.....	Power Exhaust (208-230/3 VAC)	TSC036-060*3, THC036*3, THC037*3
BAYPWRX071A.....	Power Exhaust (460/3 VAC)	TSC036-060*4, THC036*4, THC037*4
BAYPWRX072A.....	Power Exhaust (575/3 VAC)	TSC036-060*W
BAYQACB009A ^{②⑤}	Quick Adapt Roof Curb	TSC036-060, THC036, THC037
BAYQACB010A ^{②⑤}	Quick Adapt Roof Curb	TSC036-060, THC036, THC037
BAYQACB011A ^{②⑦}	Quick Adapt Roof Curb	TSC072-120, THC047-102
BAYQACB012A ^{②⑦}	Quick Adapt Roof Curb	TSC072-120, THC047-102
BAYQACB013A ^{②⑦}	Quick Adapt Roof Curb	TSC072-120, THC047-102
BAYQACB114A ^{②⑧}	Quick Adapt Roof Curb	TSC072-120H, THC048-102H
BAYQACB115A ^{②⑧}	Quick Adapt Roof Curb	TSC072-120H, THC048-102H
BAYRTEM001A ^⑩	Fully Featured ReliaTel™ Economizer Logic Model.....	All Precedents
BAYSTAT023 ^③	Remote Potentiometer.....	All Precedents
BAYSERV001A ^③	Selective Resistance Service Tester	All Precedents
BAYSENS016A ^③	Temperature Sensor.....	All Precedents
BAYSENS250A ^{③⑥}	CO2 Duct Mounted, Sensor Only.....	All Precedents (ReliaTel™)
BAYSENS251A ^{③⑥}	CO2 Wall Mounted, Sensor Only	All Precedents (ReliaTel™)
BAYTUBE005A.....	Discharge Air Sensing Kit.....	THC036-037**R
BAYTUBE007A.....	Discharge Air Sensing Kit.....	TSC072-102**R, THC047-072**R
BAYTUBE105A.....	Discharge Air Sensing Kit.....	TSC036-060**R
BAYTUBE401A.....	Discharge Air Sensing Kit.....	TSC120**R, THC074-102**R
BAYTUBE403A.....	Discharge Air Sensing Kit.....	THC120F*R
BAYVNOR001B ^{③④⑤}	Ventilation Override Kit w/ReliaTel™ options module.....	All Precedents

① For ReliaTel™ microprocessor controlled units only. Must be factory installed for electromechanical controlled units.
 ② Lynn Haven Manufacturing has a No-Return policy for this roof curb.
 ③ For use with ReliaTel™ controlled units only.
 ④ BAYABRD001C is required when ordering field installed accessories Clogged Filter Switch (BAYDFPS003A), Fan Fail Switch (BAYDFPS004A), Discharge Air Sensing Kit (BAYTUBE004A) or Evaporator Defrost Control (Frostat) (BAYLOAM020B) Ventilation Override Kit (BAYVNOR001B) unless the following options are factory installed: Frostat, Smoke Detector, Clogged Filter Switch, Fan Failure Switch, Discharge Air Sensing Kit. These factory installed options include the ReliaTel™ Options Module.
 ⑤ BAYQACB009A adapts Voyager BAYCURB021B to accept Precedent™ 3-5 ton unit. BAYQACB010A adapts Voyager BAYCURB022B to accept Precedent™ unit.
 ⑥ Cannot be used in conjunction with Barometric Relief. Order Economizer without Barometric Relief.
 ⑦ BAYQACB012A adapts Voyager BAYCURB025A to accept Precedent™ 6-10 ton unit. BAYQACB013A adapts Voyager BAYCURB026A to accept Precedent™ 6-10 ton unit.
 ⑧ Interface allows a unit with ReliaTel™ Controls to communicate with Tracer 100, Tracker, VariTrac II, and is the preferred method of communication to Tracer Summit.
 ⑨ Field installed accessory requires economizer.
 ⑩ When ordering a field installed power exhaust on a unit with electromechanical controls, BAYLMSW001A must be ordered.
 ⑪ If any version of comparative or reference enthalpy is ordered, BAYRTEM001A does not need to be ordered.
 ⑫ Order only when unit has factory installed Demand Control Ventilation option.
 ⑬ Precedent E cabinet to Precedent D cabinet (BAYCURB044 to BAYCURB043)
 ⑭ Precedent B cabinet to Precedent C cabinet (BAYCURB042 to BAYCURB043)

Light Commercial
Packaged Cooling

BUILT TO A HIGHER STANDARD

American Standard
HEATING & AIR CONDITIONING

Packaged Cooling Convertible 3-10 Tons, R-410A Zone Sensors / Thermostats

Table LPC-11-A — Zone Sensors for ReliaTel™ Controlled Units

Model Number	Description	Used With
ASYSTAT106A	Single Setpoint Manual Changeover	T*C036-120*R
ASYSTAT107A	Single Setpoint	T*C036-120*, R
ASYSTAT108A	Dual Setpoint Manual or Auto Changeover	T*C036-120*R
ASYSTAT109A	Dual Setpoint Changeover Sensor	T*C036-120*, R
ASYSTAT111A	Remote Room Sensor	
ASYSTAT777A	Programmable Night Setback w/System Function Lights (Vertical Style)	T*C036-120*R
ASYSTAT708A	Programmable Night Setback w/System Function Lights	T*C036-120*R
ASYSTAT710A	Wall Mounted Humidity Sensor	T*C036,120A,3,4,W-R,T*C036-120*_R
ASYSTAT711A	Duct Mounted Humidity Sensor	T*C036-120*,T*C036-120*_R
BAYSENS924A	Title 24 Zone Sensor [Ⓢ]	All
BAYMTPL110A	Retrofit Wall Cover Plate Kit 7.25" x 6.0"	ASYSTAT111A

[Ⓢ] Must be used with ReliaTel™ Control and BCI Communications Interface
*Either standard or high efficiency models.

Table LPC-11-B — Thermostats — Electromechanical

Model Number	Description	Used With
ASYSTAT712B	CO2 Sensor Kit (Wall Mounted)	T*C036-120*R
ASYSTAT714B	CO2 Sensor Kit (Duct Mounted)	T*C036-120*R

Light Commercial
Packaged Cooling

Alternating Lead/Lag – Dual Compressor Models Only —

During periods of part load operation, each compressor cycles alternately as circuit number one, equalizing compressor wear and run time. Enabled by cutting the wire (BLUE) at (RTRM) junction number J3-8. **Standard**

Anti Short Cycle Timer (ASCT) Function — Provides a three (3) minute minimum “ON” time and a three (3) minute minimum “OFF” time for compressors, enhances compressor reliability by ensuring proper oil return. **Standard**

Built In Evaporator Defrost Control (EDC) Function — Provides low ambient cooling down to 0°F. **Standard**

Built In Fan Delay Relay (FDR) Function — Provides custom indoor fan timing sequences for the different types of equipment, enhancing efficiency and reliability. **Standard**

Built In Night Set Back and Unoccupied Functions^① — When using a standard dual setpoint/auto change over Zone Sensor Module (ZSM), this function is enabled by applying a short across terminal J6-11 and J6-12. Sets cooling setpoint up a minimum of 7°F, sets heating setpoint back a minimum of 7°F, forces outside air damper (if present) minimum position to zero, and forces fan operation to automatic. **Accessory (requires time clock accessory or field supplied/installed switch or contacts).**

Built In “TEST” Mode — Aids in quick verification of system and control operation, exercises both hardware and software (no special tools required). **Standard**

Built In Unoccupied Mode^① — When using a standard single setpoint/manual change over Zone Sensor Module (ZSM), this function is enabled by applying a short across terminal J6-11 and J6-12. Forces outside air damper (if present) minimum position to zero, forces fan operation to automatic. **Accessory (requires time clock accessory or field supplied/installed switch or contacts).**

Direct Digital Control (DDC)^① — Proportional Integral (PI) control. Proportional – sets corrective action proportional to deviation from setpoint. Integral – fine tunes the rate of corrective action proportional to the error (results in superior space temperature control). **Standard**

Economizer Preferred Cooling^① — Provides fully integrated operation if required. Will not turn on a compressor with the economizer, if the space is recovering adequately with the economizer alone (0.2°F/minute). Allows the equipment to be utilized in more varied applications. **Standard with economizer accessory.**

Emergency Stop Terminals On Low Voltage Terminal Board (LTB-5 and LTB-6) — Provides a convenient point to disable the equipment completely, and immediately. Still provides communication to BAS. **Standard**

Heat Pump Smart Recovery and Smart Staging^① — Inhibits auxiliary heat operation if the space is recovering adequately (0.1°F/minute) with the heat pump alone, providing considerable savings in operating costs. **Standard**

Heat Pump Soft Start — Provides a smooth transition into heating after defrost, minimizing noise and compressor stress associated with switch over. **Standard**

Increased Reliability — Fewer components (moving electro-mechanical parts), less likelihood of equipment down time or failure. **Standard**

Integral Electric Heat Staging^① — Stages electric heaters “OFF” and “ON”, eliminating the use of outdated sequencers. **Standard**

Intelligent Fallback^① — A built in Default Control provides adaptive operation, which allows the equipment to continue to operate, providing comfort in the event of certain component failures. Also, allows emergency operation without a Zone Sensor Module (ZSM). **Standard**

Low Ambient Start Timer (LAST) Function — Bypasses low pressure control when a compressor starts, eliminating nuisance compressor lock outs. **Standard**

Lower Installation Cost — Using a standard Zone Sensor Module (ZSM), control voltage wiring may be run up to five (5) times further than any electromechanical system, with no increase in wire gauge. Example: Electromechanical System – 30 feet maximum using 22 gauge wire. Micro Control System – 150 feet using 22 gauge wire. **Standard**

On Board Diagnostics^① — Assist with equipment troubleshooting, if a problem occurrence should take place. **Standard**

Remote Sensing^① — All standard Zone Sensor Modules (ZSMs) have remote sensing capabilities, typically achieved by using an expensive program-mable thermostat and remote sensor with electromechanical equipment. **Accessory (requires use of remote sensor).**

Selectable Economizer Dry Bulb Change Over — Allows the capability of selecting the following dry bulb change over points: 63, 67, 70 or 73°F. **Standard with economizer accessory.**

Space Temperature Averaging^① — All standard Zone Sensor Modules (ZSMs) have space temperature averaging capabilities, typically achieved by using an expensive programmable thermostat and minimum of four (4) remote sensors with electromechanical equipment. **Averaging with ReliaTel™ can be achieved with two (2) sensors.**

Supply Air Tempering^① — A built in feature, once enabled only through an ICS device, may also be enabled using a digital or programmable Zone Sensor Module. When in the HEAT mode (and not actively heating), if supply air temperature drops 10°F below the heating setpoint, heat is turned on until supply air temperature rises to a point 10°F above the heating setpoint. Provides temperate air during the “OFF” cycle, and eliminates cold air dumping from supply ducts. Extremely effective when introducing any quantity of fresh air. **Standard when using a RTOM, ICS device, digital, or programmable Zone Sensor Module.**

Time Delay Relay (TDR) Function — Provides an incremental staging delay between compressors, minimizes equipment current inrush and consumption by keeping compressors from starting simultaneously. **Standard**

Low Pressure and High Pressure Compressor Lockout — 3 trips will lockout control.

① Denotes features lost from utilizing standard conventional stat.

ReliaTel™ Controls

Operation With An Electromechanical Thermostat

When the ReliaTel™ RTRM Thermostat Interface is used, equipment operation differs significantly. The basic equipment protection features remain intact, and the following features and benefits are **LOST**:

- **Direct Digital Control (DDC)** – Proportional Integral (PI) control is lost, equipment is controlled by a thermostat or generic building automation system device.
- **Intelligent Fall back** is lost, if a failure occurs in the device controlling the equipment, operation will cease.
- Installation is more costly, with the addition of a thermostat or generic control, the control wiring size must be increased.
- **Heat Pump Smart Recovery and Smart Staging** is lost, Heat Pump operation becomes more costly unless generic control being applied can accomplish this.
- **Remote Sensing** capabilities are lost, unless generic control being applied can accomplish this.
- **Low ambient disabled economizer and second condensing fan cycling capability.**
- **Space Temperature Averaging** capabilities are lost, unless generic control being applied can accomplish this.
- **Supply Air Tempering** feature is lost, discharge air temperature may be cold when not actively heating if outdoor air is being introduced through the equipment.
- **Built In Night Set Back and Unoccupied** functions are lost, unless generic control being applied can accomplish this.
- **Built In Unoccupied Mode** is lost, unless generic control being applied can accomplish this.
- **Economizer Preferred Cooling Feature** is lost, all compressor operation is locked out below 50°F.

Packaged Cooling with ReliaTel™ Controls 12½-25 Tons, R-410A

12½-25 Ton T*D-G – Downflow
12½-25 Ton T*H-G – Horizontal

- ReliaTel™ control features are listed on page LPC-12
- Built-in anti-short cycle, time-delay relay and minimum on time controls
- 2" throwaway filters
- Liquid line drier
- Built-in fork lift holes

- Operating charge of R-410A
- Quick-Access on 12½ – 25
- Sloped sheet metal drain pan
- Dedicated horizontal and downflow units
- Single point power for electric heat
- Complete line of optional electric heaters
- Internally enhanced coil tubing
- Low ambient to 0°F standard
- Colored and numbered wiring
- Phase monitor
- Quick-adjust idler arm pulley. Adjust belt tension, change belts, adjust airflow quickly (12½ – 25 tons), downflow only
- UL listed and CSA certified
- **5-year limited compressor warranty (12½ – 25 tons)**

Table LPC-14-A — High Efficiency ReliaTel™ Units (R-410A)

Tons	Unit Model No.	Power Supply Volts/Phase/Hz	Performance EER	Cooling Capacity (Btuh)	Dimensions (in.) H x W x L	Shipping Weight (lbs.)	MCA ^②	Max Fuse Size or Max Circuit Breaker ^①	Downflow ^③ Roofcurb
12½	TH*150G3R0B0000	208-230/3/60	13.5	144,000	54 x 85 ⁵ / ₁₆ x 122 ⁵ / ₁₆	2514	65	90	BAYCURB027B
15	TH*180G3R0B0000	208-230/3/60	14.0	174,000	64 1/8 x 85 ⁵ / ₁₆ x 122 ⁵ / ₁₆	2482	68	90	BAYCURB027B
17½	TH*210G3R0B0000	208-230/3/60	13.0	204,000	64 1/8 x 85 ⁵ / ₁₆ x 122 ⁵ / ₁₆	2443	86	110	BAYCURB027B
20	TH*240G3R0B0000	208-230/3/60	12.4	234,000	64 1/8 x 85 ⁵ / ₁₆ x 122 ⁵ / ₁₆	2513	99	125	BAYCURB027B
25	TH*300G3R0B0000	208-230/3/60	12.4	274,000	64 1/8 x 85 ⁵ / ₁₆ x 122 ⁵ / ₁₆	2514	121	150	BAYCURB027B
12½	TH*150G4R0B0000	460/3/60	13.5	144,000	54 x 85 ⁵ / ₁₆ x 122 ⁵ / ₁₆	2514	30	40	BAYCURB027B
15	TH*180G4R0B0000	460/3/60	14.0	174,000	64 ¹ / ₈ x 85 ⁵ / ₁₆ x 122 ⁵ / ₁₆	2482	33	45	BAYCURB027B
17½	TH*210G4R0B0000	460/3/60	13.0	204,000	64 ¹ / ₈ x 85 ⁵ / ₁₆ x 122 ⁵ / ₁₆	2443	43	60	BAYCURB027B
20	TH*240G4R0B0000	460/3/60	12.4	234,000	64 ¹ / ₈ x 85 ⁵ / ₁₆ x 122 ⁵ / ₁₆	2513	46	60	BAYCURB027B
25	TH*300G4R0B0000	460/3/60	12.4	274,000	64 ¹ / ₈ x 85 ⁵ / ₁₆ x 122 ⁵ / ₁₆	2514	57	70	BAYCURB027B
12½	TH*150GWR0B0000	575/3/60	13.5	144,000	54 x 85 ⁵ / ₁₆ x 122 ⁵ / ₁₆	2514	24	30	BAYCURB027B
15	TH*180GWR0B0000	575/3/60	14.0	174,000	64 ¹ / ₈ x 85 ⁵ / ₁₆ x 122 ⁵ / ₁₆	2482	26	35	BAYCURB027B
17½	TH*210GWR0B0000	575/3/60	13.0	204,000	64 ¹ / ₈ x 85 ⁵ / ₁₆ x 122 ⁵ / ₁₆	2443	33	45	BAYCURB027B
20	TH*240GWR0B0000	575/3/60	12.4	234,000	64 ¹ / ₈ x 85 ⁵ / ₁₆ x 122 ⁵ / ₁₆	2513	38	50	BAYCURB027B
25	TH*300GWR0B0000	575/3/60	12.4	274,000	64 ¹ / ₈ x 85 ⁵ / ₁₆ x 122 ⁵ / ₁₆	2514	44	50	BAYCURB027B

Table LPC-14-B — Standard Efficiency ReliaTel™ Units (R-410A)

Tons	Unit Model No.	Power Supply Volts/Phase/Hz	Performance EER	Cooling Capacity (Btuh)	Dimensions (in.) H x W x L	Shipping Weight (lbs.)	MCA ^②	Max Fuse Size or Max Circuit Breaker ^①	Downflow ^③ Roofcurb
12½	TS*150G3R0A0000	208-230/3/60	12.2	140,000	50 ¹ / ₈ x 71 ⁵ / ₈ x 107 ⁵ / ₁₆	1781	64	80	BAYCURB026B
15	TS*180G3R0A0000	208-230/3/60	12.2	176,000	54 x 85 ⁵ / ₁₆ x 122 ⁵ / ₁₆	2281	75	100	BAYCURB027B
17½	TS*210G3R0A0000	208-230/3/60	12.2	193,000	54 x 85 ⁵ / ₁₆ x 122 ⁵ / ₁₆	2292	93	125	BAYCURB027B
20	TS*240G3R0A0000	208-230/3/60	11.4	240,000	54 x 85 ⁵ / ₁₆ x 122 ⁵ / ₁₆	2353	108	125	BAYCURB027B
25	TS*300G3R0A0000	208-230/3/60	11.4	272,000	54 x 85 ⁵ / ₁₆ x 122 ⁵ / ₁₆	2337	124	150	BAYCURB027B
12½	TS*150G4R0A0000	460/3/60	12.2	140,000	50 ¹ / ₈ x 71 ⁵ / ₈ x 107 ⁵ / ₁₆	1781	31	40	BAYCURB026B
15	TS*180G4R0A0000	460/3/60	12.2	176,000	54 x 85 5/16 x 122 ⁵ / ₁₆	2281	28	50	BAYCURB027B
17½	TS*210G4R0A0000	460/3/60	12.2	193,000	54 x 85 5/16 x 122 ⁵ / ₁₆	2292	44	60	BAYCURB027B
20	TS*240G4R0A0000	460/3/60	11.4	240,000	54 x 85 5/16 x 122 ⁵ / ₁₆	2353	52	70	BAYCURB027B
25	TS*300G4R0A0000	460/3/60	11.4	272,000	54 x 85 5/16 x 122 ⁵ / ₁₆	2337	59	70	BAYCURB027B
12½	TS*150GWR0A0000	575/3/60	12.2	140,000	50 ¹ / ₈ x 71 ⁵ / ₈ x 107 ⁵ / ₁₆	1781	23	30	BAYCURB026B
15	TS*180GWR0A0000	575/3/60	12.2	176,000	54 x 85 ⁵ / ₁₆ x 122 ⁵ / ₁₆	2281	31	40	BAYCURB027B
17½	TS*210GWR0A0000	575/3/60	12.2	193,000	54 x 85 ⁵ / ₁₆ x 122 ⁵ / ₁₆	2292	35	50	BAYCURB027B
20	TS*240GWR0A0000	575/3/60	11.4	240,000	54 x 85 ⁵ / ₁₆ x 122 ⁵ / ₁₆	2353	44	60	BAYCURB027B
25	TS*300GWR0A0000	575/3/60	11.4	272,000	54 x 85 ⁵ / ₁₆ x 122 ⁵ / ₁₆	2337	48	60	BAYCURB027B

① HACR type circuit breaker per NEC.

② Information subject to change. Please confirm with current Product Data/Service Facts for current factory production.

③ Downflow only.

④ 278,000 in the horizontal airflow configuration.

* Digit 3 - H = Horizontal or D = Downflow.

Light Commercial
Packaged Cooling

Packaged Cooling with ReliaTel™ Controls 12½-25 Tons (Model Digit Numbers)

Digit	Description	Order Number	Digit	Description	Order Number			
1	Unit Type			Through The Base Electric/Gas ^①	C			
	Packaged Cooling, Electric Heat.....	T		Through The Base Access ^①	D			
2	Efficiency		19	Disconnect Switch/Circuit Breaker				
	Packaged Gas/Electric.....	Y		No Disconnect/circuit break.....	0			
3	Airflow Configuration			Unit Mounted Non-Fused Disconnect Switch.....	1			
	Standard Efficiency.....	S		Unit Mounted Circuit Breaker.....	2			
4-6	Nominal Gross Cooling Capacity (MBh)		20	Convenience Outlet Option				
	High Efficiency.....	H		Without Convenience Outlet.....	0			
7	Major Design Sequence	Downflow.....		Unpowered Convenience Outlet.....	A			
		12½ Tons.....	150	Powered Convenience Outlet.....	B			
		15 Tons.....	180	21	Communications Options			
		17½ Tons.....	210		Without Communications Options.....	0		
		20 Tons.....	240		Novar 2024 Controls Interface ^②	3		
25 Tons.....	300	Novar 3051 Controls Interface ^②	4					
8	Voltage Selection	Microchannel Type Condenser Coils.....	F	Novar 3051 Communications Interface with Demand Control Ventilation ^④	5			
		208-230/60/3.....	3	Building Automation Control Network Communications Interface.....	6			
9	Unit Controls	460/60/3.....	4	22	Refrigeration System Option			
		575/60/3.....	W		Standard refrigeration system.....	0		
		380/60/3.....	K		Thermal Expansion Valve (TXV).....	A		
		ReliaTel™.....	R	23	Refrigeration Controls			
10	Heating Capacity	Without Refrigeration Controls.....	0		Froststat.....	1		
		No Heat ^②	0	24	Smoke Detector			
		18 kW Electric Heat ^②	G		Without Smoke Detector.....	0		
		27 kW Electric Heat ^②	K	Return Air Smoke Detector.....	A			
		36 kW Electric Heat ^②	N	Supply Air Smoke Detector.....	B			
		54 kW Electric Heat ^②	P	Return/Supply Air Smoke Detector.....	C			
		72 kW Electric Heat ^②	R	Plenum Smoke Detector.....	D			
		Gas Heat - High ^①	H	25	System Monitoring Controls			
		Gas Heat - Low ^①	L		No Monitoring Controls.....	0		
		Gas Heat - SS Ht Ex - Modulating ^①	V		Clogged Filter Switch.....	1		
		Gas Heat - SS Ht Ex - Low ^①	X		Fan Failure Switch.....	2		
Gas Heat - SS Ht Ex - High ^①	Z	Discharge Air Sensing.....	3					
11	Minor Design Sequence	Discharge Air Sensing.....	4		Clogged Filter Switch and Fan Failure switch.....	4		
		Discharge Air Sensing.....	5		Clogged Filter Switch and Discharge Air Sensing.....	5		
12-13	Service Sequence	Clogged Filter Switch and Discharge Air Sensing.....	6		Fan Failure Switch and Discharge Air Sensing.....	6		
		Clogged Filter Switch, Fan Failure Switch and Discharge Air Sensing.....	7		Discharge Air Sensing.....	7		
14	Fresh Air Selection	NOVAR Return Air Sensor (Novar 2024) ^④	8		NOVAR Zone Temp Sensor(Novar 3051) ^④	9		
		No Fresh Air.....	0		Condensate Drain Pan Overflow Switch.....	A		
		Econ Dry Bulb w/ Barometric Relief.....	D	Clogged Filter Switch and Condensate Drain Pan Overflow Switch.....	B			
		Econ Reference Enthalpy w/Barometric Relief.....	F	Fan Failure Switch and Condensate Drain Pan Overflow Switch.....	C			
		Econ Comparative Enthalpy w/Barometric Relief.....	H	Discharge Air Sensing and Condensate Drain Pan Overflow Switch.....	D			
		Low Leak Economizer, Dry Bulb with Barometric Relief.....	K	Clogged Filter Switch, Fan Failure Switch and Condensate Drain Pan Overflow Switch.....	E			
		Low Leak Economizer, Comparative Enthalpy with Barometric Relief.....	M	Clogged Filter Switch, Discharge Air Sensing Tube and Condensate Drain Pan Overflow Switch.....	F			
		Low Leak Economizer, Reference Enthalpy with Barometric Relief.....	P	Fan Failure Switch, Discharge Air Sensing Tube and Condensate Drain Pan Overflow Switch.....	G			
		15	Supply Fan/Drive Type/Motor	Clogged Filter Switch, Fan Failure Switch, Discharge Air Sensing and Condensate Drain Pan Overflow Switch.....	H	26	System Monitoring Controls	
				Standard Motor.....	0		No Monitoring Controls.....	0
				Oversized Motor.....	1	Demand Control Ventilation (CO ₂) ^⑤	A	
				High Efficiency Motor.....	3	Fault Detection and Diagnostics (FDD).....	B	
				Single Zone Variable Air Volume Standard Motor.....	6	Fault Detection and Diagnostics (FDD) with Demand Control Ventilation.....	C	
				Multi-Speed Standard Motor.....	7	27	Unit Hardware Enhancements	
				Single Zone Variable Air Volume Oversized Motor.....	8		No Enhancements.....	0
				Multi-Speed Oversized Motor.....	9	Stainless Steel Drain Pan.....	1	
				Single Zone Variable Air Volume Standard Motor w/Shaft Ground Ring.....	A	28	Short Circuit Current Rating (SCCR)	
Multi-Speed Standard Motor w/Shaft Ground Ring.....	B			Standard SCCR.....	0			
Single Zone Variable Air Volume Oversized Motor w/Shaft Ground Ring.....	C			65 kA SCCR.....	A			
Multi-Speed Oversized Motor w/Shaft Ground Ring.....	D	31	Advanced Unit Controls					
16	Hinged Service Access / Filters		Standard Unit Controls.....	0				
			Standard Panels/Standard Filters.....	0	Human Interface.....	1		
		Hinged Access/Standard Filters.....	A					
Standard Panels/MERV 8 Filters.....	B	Note: Most Factory Installed Options available for Downflow Air Discharge units only. Please verify with ordering system for availability.						
Hinged Access/MERV 8 Filters.....	C	① Applicable to Digit 1 Y models only.	⑥ Novar is not available with SZ VAV products.	⑦ Demand Control Ventilation Option includes wiring only. The CO ₂ sensor is a field-installed only option.				
Standard Panels/MERV 13 Filters.....	D							
Hinged Access/MERV 13 Filters.....	E	② Applicable to Digit 1 T models only.	⑧	⑨				
17	Condenser Coil Protection				Standard Coil.....	0		
		Standard Coil With Hail Guard.....	1					
		CompleteCoat™ Condenser Coil.....	4					
		CompleteCoat™ Condenser Coil with Hail Guard.....	5					
		Through The Base Provisions.						
No Through The Base Provisions ^③	0	③ Applicable to Digit 1, T or Y models.	⑩	⑪				
Through The Base Electric ^③	A							
Through The Base Gas ^①	B							

Light Commercial Packaged Cooling

**For additional Controls Information:
 See ReliaTel™ and Micro Control features on PC-12 and PC-13.**

For complete equipment / combination selections, installation instructions and warranty information, please refer to Product Data/Ratings and/or Installers Guides and Limited Warranty Handbooks.

BUILT TO A HIGHER STANDARD[®]

American Standard[®]
HEATING & AIR CONDITIONING

Packaged Cooling with ReliaTel™ Controls 12½-25 Tons, R-410A Zone Sensors / Thermostats

Table LPC-16-B — Zone Sensors for ReliaTel™

Model Number	Description	Used With
ASYSTAT106A	Single Setpoint Manual Changeover	YC*150-301
ASYSTAT108A	Dual Setpoint Manual or Automatic Changeover	YC*150-301
ASYSTAT111A	Remote Room Sensor	ASYSTAT777A
ASYSTAT777A	Programmable Night Setback	YC*150-301
ASYSTAT710A	Wall Mounted Humidity Sensor	YFD151,181,241 (with Reheat)
ASYSTAT711A	Duct Mounted Humidity Sensor	YFD151,181,241 (with Reheat)
BAYSENS924A ^①	Title 24 Zone Sensor	All
BAYMTPL110A	Retrofit Wall Cover Plate Kit 7.25" x 6.0"	ASYSTAT777A

① Must be used with ReliaTel™ Control and BCI Communications Interface

Packaged Cooling with ReliaTel™ Controls 12½-25 Tons Accessories

Table LPC-17-A — Field Installed Accessories

For complete list of of All Factory Installed Options refer to FLOPS section of this book.

Model Number	Description	Used With
BAYBCIR001A.....	BACnet™ Communication Interface.....	All Voyagers
BAYABRD002B⑧.....	ReliaTel™ Options Module.....	All Voyagers
BAYCO2K002B⑨.....	CO ₂ Sensor Wall Mounted.....	All Voyagers w/Economizers
BAYCO2K004B⑨.....	CO ₂ Sensor Duct Mounted.....	All Voyagers w/Economizers
BAYCURB026B⑤⑥.....	Downflow Roof Curb (Can not be adapted for horizontal use)	TSD150G
BAYCURB027B⑤⑥.....	Downflow Roof Curb (Can not be adapted for horizontal use)	THD150G-300G, TSD180-300G
BAYDFPS005A⑦⑨.....	Clogged Filter Switch (MERV 7).....	All Voyagers
BAYDFPS006A⑦⑨.....	Fan Failure Switch.....	All Voyagers
BAYDFPS013A.....	Clogged Filter Switch (MERV 13).....	All Voyagers
BAYDMPR029C.....	0-25% Manual Outside Air Damper.....	All Voyagers
BAYDMPR057A.....	0-50% Motorized Outside Air Damper.....	TSD150G
BAYDMPR058A.....	0-50% Motorized Outside Air Damper.....	TSD151G-300G, TSD180G-300G
BAYECON089A⑧.....	Downflow Economizer with Barometric Relief.....	TSD150G
BAYECON090A⑧.....	Downflow Economizer with Barometric Relief.....	TSD151G-300G, TSD180G-300G
BAYECON091A.....	Horizontal Economizer	TSH150G
BAYECON092A.....	Horizontal Economizer	TSH151G-300G, TSF180G-300G
BAYECON700A.....	Downflow Low Leak Economizer.....	TSD150G
BAYECON701A.....	Downflow Low Leak Economizer.....	TSD180G-300G, THD150G, THD180-300G
BAYENTH007A①②.....	Reference Enthalpy Kit.....	All BAYECON089-92A
BAYENTH008A①③.....	Comparative Enthalpy Kit.....	All BAYECON089-92A
BAYFRST003A.....	High Temperature Stat	All Voyagers
BAYGARD144A④.....	Tool-less Hail Guard.....	TS*150G
BAYGARD145A④.....	Tool-less Hail Guard.....	TH*150G, TS*210G, TS*240G, TS*300G
BAYGARD150A.....	Tool-less Hail Guard.....	TH*180G, TH*210G, TH*240G, TH*300G
BAYHSDR005B④.....	High Static Drive	TS*150G, TH*150G, TH*180G
BAYHSDR010A④.....	High Static Drive	TH*210G, TH*240G, TS*300G
BAYHSDR011A④.....	High Static Drive	TS*210G, TS*240G, TH*300G
BAYHSDR016A.....	High Static Drive	TS*180G

- ① Kit contains all necessary parts to achieve desired level of Enthalpy Control.
- ② Reference Enthalpy senses outside temperature/humidity and inside return/mixed air temperature/humidity.
- ③ Comparative Enthalpy senses outside temperature/humidity and inside return/mixed air temperature/humidity.
- ④ High static drive and oversized motors are mutually exclusive, Do Not Combine.
- ⑤ Clarksville manufacturing has a no return policy for this roof curb.
- ⑥ For downflow use only. Can not be adapted for horizontal units.
- ⑦ BAYABRD002B is required when ordering field installed BAYDFPS005A or 006A, BAYTUBE008A or 009A and BAYLOAM023A or BAYVNOR002B.
- ⑧ Field or factory installed option.
- ⑨ Field installed accessory. Requires an economizer.

Light Commercial
Packaged Cooling

Packaged Cooling with ReliaTel™ Controls 12½-25 Tons Accessories

Table LPC-18-A — Field Installed Accessories

Model Number	Description	Used With
BAYHSMT039B ^{①⑥}	5HP Oversized Motor Kit (208-230/460V)	TS*150G
BAYHSMT040B ^{①⑥}	5HP Oversized Motor Kit (575V)	TS*150G
BAYHSMT055B ^{①⑥}	5HP Oversized Motor Kit (208-230/460V)	TS*180G
BAYHSMT042A ^{①⑥}	7-1/2HP Oversized Motor Kit (575V)	TS*210G, TH*210G, TS*240G, TH*240G
BAYHSMT072A ^{①⑥}	7-1/2HP Oversized Motor Kit (575V)	TS*180G, TH*180G
BAYHSMT098A ^{①⑥}	7-1/2HP Oversized Motor Kit (208-230V)	TH*210G, TH*240G
BAYHSMT099A ^{①⑥}	7-1/2HP Oversized Motor Kit (460V)	TH*210G, TH*240G
BAYLOAM023A ^⑥	Evaporator Defrost Control Froststat	TS*150G, TH*150G TS*180G TS*210G, TS*240G, TS*300G
BAYLOAM031A	Evaporator Defrost Control Froststat	TH*180G, TH*210G, TH*240G, TH*300G
BAYLSDR004A ^②	Low Static Drive	TS*150G, TS*180G, TS*210G TH*210G, TH*240G, TS*240G
BAYLSDR002A ^②	Low Static Drive	TH*150G, TH*180G, TH*300G
BAYPWRX029A	Power Exhaust for all Voyagers 12½-25 Ton 230V units	BAYECON089-090A, TCD150-301
BAYPWRX030A	Power Exhaust for all Voyagers 12½-25 Ton 460V units	BAYECON089-090A, TCD150-301
BAYPWRX031A	Power Exhaust for all Voyagers 12½-25 Ton 575V units	BAYECON089-090A, TCD150-301
BAYSERV001A	Selective Resistance Service Tester	All TC*150F-TC*301F
BAYSTAT023 ^③	Remote Potentiometer	All Economizers and 0-50% Motorized Air Dampers
BAYTUBE008A ^{④⑤⑥}	Discharge Air Sensing Kit	All TCD150F-TCD301F
BAYTUBE009A ^{④⑤⑥}	Discharge Air Sensing Kit	All TCH150F-TCH301F
BAYQACB044A	Adapter Curb	BAYCURB026A/B to BAYCURB027A/B
BAYVNOR002B ^⑤	Ventilation Override Kit	TC*150-301 w/ReliaTel™ Options Module

- ① High static drive and oversized motors are mutually exclusive, Do Not Combine.
- ② Low static drive and oversized motors are mutually exclusive, Do Not Combine.
- ③ Cannot be used with Integrated Comfort™ Systems.
- ④ Used for true discharge air sensing in both heating and cooling models.
- ⑤ BAYABRD002B is required when ordering field installed BAYDFPS005A or 006A, BAYTUBE008A or 009A and BAYLOAM031A or BAYVNOR002B.
- ⑥ Field or factory installed option.

Light Commercial
Packaged Cooling

Packaged Cooling with ReliaTel™ Controls 12½-25 Tons Heaters

Table LPC-19-A — Downflow Supplementary Heaters:

Model Number	Power Supply	kW Rating	Nominal BTUH	No. Stages	Used With
AYDHTRK318A	208-230/3/60	13.5/18.0	46,100/61,400	1	TSD150G-180G, THD150G-180G
AYDHTRK336A	208-230/3/60	27.0/36.0	92,200/122,900	2	TSD150G-180G, THD150G-180G
AYDHTRK354A	208-230/3/60	40.5/54.0	138,200/184,300	2	TSD150G-180G, THD150G-180G
AYDHTRL418A	460/3/60	18.0	61,400	1	TSD150G-180G, THD150G-180G
AYDHTRK427A	460/3/60	27.0	92,150	2	THD180G
AYDHTRK436A	460/3/60	36.0	122,900	2	TSD150G-180G, THD150G-180G
AYDHTRK454A	460/3/60	54.0	184,300	2	TSD150G-180G, THD150G-180G
AYDHTRL336A	208-230/3/60	27.0/36.0	92,200/122,900	2	TSD210G-300G, THD210-300G
AYDHTRL354A	208-230/3/60	40.5/54.0	138,200/184,300	2	TSD210G-300G, THD210-300G
AYDHTRK372A	208-230/3/60	54.0/72.0	184,300/245,700	2	TSD210G-300G, THD210-300G
AYDHTRL427A	460/3/60	27.0	92,150	2	THD210G, THD240-300G
AYDHTRL436A	460/3/60	36.0	122,900	2	TSD210G-300G, THD210-300G
AYDHTRL454A	460/3/60	54.0	184,300	2	TSD210G-300G, THD210-300G
AYDHTRK472A	460/3/60	72.0	245,700	2	TSD210G-300G, THD210-300G

Table LPC-19-B — Horizontal Supplementary Heaters:

Model Number	Power Supply	kW Rating	Nominal BTUH	No. Stages	Used With
AYHHTRN318A	208-230/3/60	13.5/18.0	46,000/61,400	1	TSH150G, TSH180G
AYHHTRP336A	208-230/3/60	27.0/36.0	92,200/122,900	2	TSH150G, TSH180G
AYHHTRP354A	208-230/3/60	40.5/54.0	138,200/184,300	2	TSH150G, TSH180G
AYHHTRN418A	460/3/60	18.0	61,400	1	TSH150G, TSH180G
AYHHTRP436A	460/3/60	36.0	122,900	2	TSH150G, TSH180G
AYHHTRP454A	460/3/60	54.0	184,300	2	TSH150G, TSH180G
AYHHTRN336A	208-230/3/60	27.0/36.0	92,200/122,900	2	TSH210-300G, THH210-300G
AYHHTRN354A	208-230/3/60	40.5/54.0	138,200/184,300	2	TSH210-300G, THH210-300G
AYHHTRN372A	208-230/3/60	54.0/72.0	184,300/245,700	2	TSH210-300G, THH210-300G
AYHHTRN436A	460/3/60	36.0	122,900	2	TSH210-300G, THH210-300G
AYHHTRN454A	460/3/60	54.0	184,300	2	TSH210-300G, THH210-300G
AYHHTRN472A	460/3/60	72.0	245,700	2	TSH210-300G, THH210-300G
AYHHTRM318A	208-230/3/60	13.5/18.0	46,100/61,400	1	THH150G, THH180G
AYHHTRM336A	208-230/3/60	27.0/36.0	92,200/122,900	2	THH150G, THH180G
AYHHTRM354A	208-230/3/60	40.5/54.0	138,200/184,300	2	THH150G, THH180G
AYHHTRM418A	460/3/60	18.0	61,400	1	THH150G, THH180G
AYHHTRM436A	460/3/60	36.0	122,900	2	THH150G, THH180G
AYHHTRM454A	460/3/60	54.0	184,300	2	THH150G, THH180G

Note: Unit with heater is single circuit/single point.

Packaged Cooling with ReliaTel™ Controls 12½-25 Tons Heaters

Table LPC-20-A — Downflow Supplementary Heaters:

Model Number	Power Supply	kW Rating	Nominal BTUH	No. Stages	Used With
AYDHTRLW54A	575/3/60	54.0	184,300	2	TSD210-300G, THD210-300G
AYDHTRKW18A	575/3/60	18.0	61,400	1	TSD150-180G, THD150-180G
AYDHTRKW54A	575/3/60	54.0	184,300	2	TSD150-180G, THD150-180G
AYDHTRKW72A	575/3/60	72.0	245,700	2	TSD210-300G, THD210-300G
AYDHTRMW36A	575/3/60	36.0	122,900	2	TSD150-300G, THD150-300G

Table LPC-20-B — Horizontal Supplementary Heaters:

Model Number	Power Supply	kW Rating	Nominal BTUH	No. Stages	Used With
AYHHRMW18A	575/3/60	18.0	61,400	1	THH150G, THH180G
AYHHRMW36A	575/3/60	36.0	122,900	2	TSH210G-300G, TSH150G-300G
AYHHRMW54A	575/3/60	54.0	184,300	2	THH150G, THH180G
AYHHRNW18A	575/3/60	18.0	61,400	1	TSH150G, TSH180G
AYHHRNW54A	575/3/60	54.0	184,300	2	TSH210G-300G, THH210G-300G
AYHHRNW72A	575/3/60	72.0	245,700	2	TSH210G-300G, THH210G-300G
AYHHRPW36A	575/3/60	36.0	122,900	2	TSH150G, TSH180G
AYHHRPW54A	575/3/60	54.0	184,300	2	TSH150G, TSH180G

Note: Unit with heater is single circuit/single point.

**For additional Controls Information:
See ReliaTel™ and Micro Control features on LPC-12 and LPC-13.**

For complete equipment / combination selections, installation instructions and warranty information, please refer to Product Data/Ratings and/or Installers Guides and Limited Warranty Handbooks.

BUILT TO A HIGHER STANDARD™

American Standard
HEATING & AIR CONDITIONING

Foundation™ Packaged Cooling 3-5 Tons, R-410A



- Scroll compressors on all units
- Operating Charge of R-410A
- Low ambient operation of 40 F as standard
- Color coded and numbered wiring
- Single side service access
- Provisions for through the base connections
- Phase monitor on all units
- Convertible airflow on all units
- Non-corrosive drain pan
- Separate high and low voltage areas in control box
- **5-year limited compressor and heat exchanger warranty**

Table LPC-21-A — Foundation™ - R-410A - Electromechanical Controls

Tons	Unit Model No	Power Supply Volts/Phase/Hz	Performance SEER	Cooling Capacity (Btuh)	Dimensions (in.) H x W x L	Shipping Weight (lbs.)	MCA**	Max Fuse Size or Max Circuit Breaker**	Downflow Roofcurb ^①
GBC - Three Phase No Heat									
3	EBC036A3E0B0000	208-230/3/60	14.0	36,000	42 ⁵ / ₈ x 48 x 76 ⁷ / ₈	523	19.5	25	BAYCURB320A
4	EBC048A3E0B0000	208-230/3/60	14.0	48,000	42 ⁵ / ₈ x 48 x 76 ⁷ / ₈	566	23.6	35	BAYCURB320A
5	EBC060A3E0B0000	208-230/3/60	14.0	57,500	42 ⁵ / ₈ x 48 x 76 ⁷ / ₈	586	26.4	40	BAYCURB320A
3	EBC036A4E0B0000	460/3/60	14.0	36,000	42 ⁵ / ₈ x 48 x 76 ⁷ / ₈	523	10.5	15	BAYCURB320A
4	EBC048A4E0B0000	460/3/60	14.0	48,000	42 ⁵ / ₈ x 48 x 76 ⁷ / ₈	566	11	15	BAYCURB320A
5	EBC060A4E0B0000	460/3/60	14.0	57,500	42 ⁵ / ₈ x 48 x 76 ⁷ / ₈	586	12.9	20	BAYCURB320A
3	EBC036AWE0B0000	575/3/60	14.0	36,000	42 ⁵ / ₈ x 48 x 76 ⁷ / ₈	523	6.8	15	BAYCURB320A
4	EBC048AWE0B0000	575/3/60	14.0	48,000	42 ⁵ / ₈ x 48 x 76 ⁷ / ₈	566	8.1	15	BAYCURB320A
5	EBC060AWE0B0000	575/3/60	14.0	57,500	42 ⁵ / ₈ x 48 x 76 ⁷ / ₈	586	9.2	15	BAYCURB320A

^① For Downflow units only.

** Information subject to change. Please confirm with current Product Data/Service Facts for current factory production.

Light Commercial
Packaged Cooling

BUILT TO A HIGHER STANDARD[®]

American Standard[®]
HEATING & AIR CONDITIONING

Foundation™ Packaged Cooling 3-5 Ton Accessories

Table LPC-22-A — Foundation™ — Field Installed Accessories

Model Number	Description	Used With
BAYCURB320A	Roof curb	All
BAYGARD320A	Tool-less Hail Guard	All
BAYTBUE320A	Through the base - Elec.	All
BAYDSCF320A	Unit Mounted Disconnect- cooling only, 100 Amp	GBC, EBC No Elec Heat
BAYDSCF321A	Unit Mounted Disconnect - electric heat, 100 Amp	EBC w/Elec Heat
BAYCO2K300A	Wall Mounted CO2 Sensor	All
BAYCO2K301A	Duct Mounted CO2 Sensor	All
BAYCOSW320A	Condensate Overflow	All
BAYCCHT010B	CCH - 208-230V (40 W) 6.5"	E/GBC(048 & 060)A3
BAYCCHT011B	CCH - 460V/572V (40W) 6.5"	E/GBC(048 & 060A)(4 & W)
BAYCCHT103A	CCH - 208-230V (40 W) 5.5"	E/GBC036A3
BAYCCHT405A	CCH - 460V/572V (40W) 5.5"	E/GBC036A(4 & W)
BAYLOAM330A	Frostat	All
BAYLOAM340A	Low Ambient Kit	All
BAYASCT001	Compressor Short Cycle Timer	All
BAYHSMT320A	2 HP Oversize motor Kit (208-230/460V)	All
BAYHSMT321A	2 HP Oversize motor Kit (380V)	All
BAYHSMT322A	2 HP Oversize motor Kit (575V)	All
BAYDMPR321A	Damper, Manual 3-5T	All
BAYDMPR320A	Damper, Motorized 3-5T	All
BAYBARO320A	Barometric Relief Damper, 3-5T	All
BAYECON320A	Economizer, Dry Bulb, Downflow 3-5T	All
BAYENTH320A	Reference Enthalpy Economizer, 3-5T	All
BAYENTH321A	Comparative Enthalpy Economizer, 3-5T	All
BAYECON353A ^②	Low Leak Economizer, Dry Bulb, Downflow W/FDD, 3-5T	All
BAYECON354A ^②	Low Leak Economizer, Dry Bulb, Horizontal W/FDD, 3-5T	All
BAYENTH323A ^②	Comparative Enthalpy, LLE W/FDD, 3-5T	All
BAYENTH322A ^②	Reference Enthalpy, LLE W/FDD, 3-5T	All
BAYBARO321A ^②	Barometric Relief Damper, LLE W/FDD, 3-5T	All
BAYPWRX320A ^①	Power Exhaust, 3-5T DF, 230V	All
BAYPWRX321A ^①	Power Exhaust, 3-5T DF, 460V	All
BAYPWRX322A ^①	Power Exhaust, 3-5T DF, 575V	All

① Please check availability.
② FDD = Fault Detection & Diagnostics.

Light Commercial
Packaged Cooling

BUILT TO A HIGHER STANDARD

American Standard
HEATING & AIR CONDITIONING

Foundation™ Packaged Cooling 3-5 Ton Heaters

Table LPC-23-A — Foundation™ - R-410A - Field Installed Accessories

Model No	Power Supply	kW Rating	Nominal BTUH)	No. Stages	Used With
BAYHTFA305A	208-230/3/60	3.5 / 4.7	12,800 / 17,100	1	EBC*A3*
BAYHTFA307A	208-230/3/60	5.6 / 7.5	19,200 / 25,600	1	EBC*A3*
BAYHTFA310A	208-230/3/60	7.5 / 10	25,700 / 34,200	1	EBC*A3*
BAYHTFA315A	208-230/3/60	10.8 / 14.4	38,400 / 51,200	1	EBC*A3*
BAYHTFA320A	208-230/3/60	15 / 20	51,300 / 68,300	2	EBC048A3*, EBC060A3*
BAYHTFA325A	208-230/3/60	18.8 / 25	64,100 / 85,400	2	EBC060A3*
BAYHTFA405A	460/3/60	5	17,100	1	EBC*A4*
BAYHTFA407A	460/3/60	7.5	25,600	1	EBC*A4*
BAYHTFA410A	460/3/60	10	34,200	1	EBC*A4*
BAYHTFA415A	460/3/60	15	51,200	1	EBC*A4*
BAYHTFA420A	460/3/60	20	68,300	2	EBC048A4*, EBC060A4*
BAYHTFA425A	460/3/60	25	85,400	2	EBC060A4*
BAYHTFAW10A	575/3/60	10	34,200	1	EBC*AW*
BAYHTFAW15A	575/3/60	15	51,200	1	EBC*AW*
BAYHTFAW20A	575/3/60	20	68,300	2	EBC048AW*, EBC060AW*
BAYHTFAW25A	575/3/60	25	85,400	2	EBC060AW*

Light Commercial
Packaged Cooling

For complete equipment / combination selections, installation instructions and warranty information, please refer to Product Data/Ratings and/or Installers Guides and Limited Warranty Handbooks.

BUILT TO A HIGHER STANDARD™

American Standard
HEATING & AIR CONDITIONING

Foundation™ Packaged Cooling 15-25 Tons, R-410A

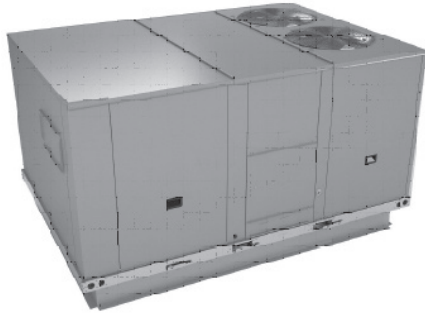

- Scroll compressors on all units
- Operating charge of R-410A
- Low ambient operation to 40°F as standard
- Color coded and numbered wiring
- Single side service access
- Molded handles on service access doors
- Separated high and low voltage compartments
- Liquid Line Refrigerant Drier
- Provisions for through the base connections
- Phase monitor on all units
- Convertible airflow
- Two inch throwaway filters as standard
- Non-corrosive & removable drain pan
- **5-year limited compressor warranty (15-25 tons)**

Table PC-24-A — Foundation™ — R-410A — Electromechanical Controls

Tons	Unit Model No.	Power Supply Volts/Phase/Hz	Performance IEER	Cooling Capacity (Btuh)	Dimensions (in.) H x W x L	Shipping Weight (lbs.)	MCA	Max Fuse Size or Max Circuit Breaker ^①	Downflow Roofcurb
15	EBC180A3E0B0000	208-230/3/60	12.4	184000	58 ⁵ / ₈ x 86 ¹⁵ / ₁₆ x 123 ¹ / ₈	2146	75	100	BAYCURB027B
17 ¹ / ₂	EBC210A3E0B0000	208-230/3/60	12.4	216000	58 ⁵ / ₈ x 86 ¹⁵ / ₁₆ x 123 ¹ / ₈	2155	86	110	BAYCURB027B
20	EBC240A3E0A0000	208-230/3/60	11.6	256000	58 ⁵ / ₈ x 86 ¹⁵ / ₁₆ x 123 ¹ / ₈	2180	97	125	BAYCURB027B
25	EBC300A3E0A0000	208-230/3/60	11.6	284000	58 ⁵ / ₈ x 86 ¹⁵ / ₁₆ x 123 ¹ / ₈	2206	126	175	BAYCURB027B
15	EBC180A3E0B0000	460/3/60	12.4	184000	58 ⁵ / ₈ x 86 ¹⁵ / ₁₆ x 123 ¹ / ₈	2146	35	45	BAYCURB027B
17 ¹ / ₂	EBC210A3E0B0000	460/3/60	12.4	216000	58 ⁵ / ₈ x 86 ¹⁵ / ₁₆ x 123 ¹ / ₈	2155	42	50	BAYCURB027B
20	EBC240A3E0A0000	460/3/60	11.6	256000	58 ⁵ / ₈ x 86 ¹⁵ / ₁₆ x 123 ¹ / ₈	2180	46	60	BAYCURB027B
25	EBC300A3E0A0000	460/3/60	11.6	284000	58 ⁵ / ₈ x 86 ¹⁵ / ₁₆ x 123 ¹ / ₈	2206	53	70	BAYCURB027B
15	EBC180A3E0B0000	575/3/60	12.4	184000	58 ⁵ / ₈ x 86 ¹⁵ / ₁₆ x 123 ¹ / ₈	2146	28	35	BAYCURB027B
17 ¹ / ₂	EBC210A3E0B0000	575/3/60	12.4	216000	58 ⁵ / ₈ x 86 ¹⁵ / ₁₆ x 123 ¹ / ₈	2155	34	45	BAYCURB027B
20	EBC240A3E0A0000	575/3/60	11.6	256000	58 ⁵ / ₈ x 86 ¹⁵ / ₁₆ x 123 ¹ / ₈	2180	38	50	BAYCURB027B
25	EBC300A3E0A0000	575/3/60	11.6	284000	58 ⁵ / ₈ x 86 ¹⁵ / ₁₆ x 123 ¹ / ₈	2206	44	50	BAYCURB027B

Table PC-24-B — Foundation™ — R-410A — Electromechanical Controls - 2-Speed Fan

Tons	Unit Model No.	Power Supply Volts/Phase/Hz	Performance IEER	Cooling Capacity (Btuh)	Dimensions (in.) H x W x L	Shipping Weight (lbs.)	MCA	Max Fuse Size or Max Circuit Breaker ^①	Downflow Roofcurb
EBC* - Three Phase No Heat									
15	EBC180A3E0B1DQY	208-230/3/60	13.2	184000	58 ⁵ / ₈ x 86 ¹⁵ / ₁₆ x 123 ¹ / ₈	2146	75	100	BAYCURB027B
17 ¹ / ₂	EBC210A3E0B1DQY	208-230/3/60	13.2	216000	58 ⁵ / ₈ x 86 ¹⁵ / ₁₆ x 123 ¹ / ₈	2155	86	110	BAYCURB027B
20	EBC240A3E0A1DQY	208-230/3/60	12.4	256000	58 ⁵ / ₈ x 86 ¹⁵ / ₁₆ x 123 ¹ / ₈	2180	97	125	BAYCURB027B
25	EBC300A3E0A1DQY	208-230/3/60	12.4	284000	58 ⁵ / ₈ x 86 ¹⁵ / ₁₆ x 123 ¹ / ₈	2206	126	175	BAYCURB027B
15	EBC180A3E0B1DQY	460/3/60	13.2	184000	58 ⁵ / ₈ x 86 ¹⁵ / ₁₆ x 123 ¹ / ₈	2146	35	45	BAYCURB027B
17 ¹ / ₂	EBC210A3E0B1DQY	460/3/60	13.2	216000	58 ⁵ / ₈ x 86 ¹⁵ / ₁₆ x 123 ¹ / ₈	2155	42	50	BAYCURB027B
20	EBC240A3E0A1DQY	460/3/60	12.4	256000	58 ⁵ / ₈ x 86 ¹⁵ / ₁₆ x 123 ¹ / ₈	2180	46	60	BAYCURB027B
25	EBC300A3E0A1DQY	460/3/60	12.4	284000	58 ⁵ / ₈ x 86 ¹⁵ / ₁₆ x 123 ¹ / ₈	2206	53	70	BAYCURB027B
15	EBC180A3E0A1DQY	575/3/60	13.2	184000	58 ⁵ / ₈ x 86 ¹⁵ / ₁₆ x 123 ¹ / ₈	2146	28	35	BAYCURB027B
17 ¹ / ₂	EBC210A3E0A1DQY	575/3/60	13.2	216000	58 ⁵ / ₈ x 86 ¹⁵ / ₁₆ x 123 ¹ / ₈	2155	34	45	BAYCURB027B
20	EBC240A3E0A1DQY	575/3/60	12.4	256000	58 ⁵ / ₈ x 86 ¹⁵ / ₁₆ x 123 ¹ / ₈	2180	38	50	BAYCURB027B
25	EBC300A3E0A1DQY	575/3/60	12.4	284000	58 ⁵ / ₈ x 86 ¹⁵ / ₁₆ x 123 ¹ / ₈	2206	44	50	BAYCURB027B

① HACR Circuit Breaker Type Per NEC.

Information subject to change. Please confirm with current Product Data for current factory production.

Light Commercial
Packaged Cooling

For complete equipment / combination selections, installation instructions and warranty information, please refer to Product Data/Ratings and/or Installers Guides and Limited Warranty Handbooks.

Foundation™ Packaged Cooling 15-25 Tons Accessories

Table LPC-25-A — Foundation™ - R-410A - Field Installed Accessories

Model Number	Description	Used With
BAYTBUE300A	Through the Base Electrical Connections	All Foundation 15-25 Ton Units
BAYDSCF300A	Unit Mounted Disconnect, 100 Amp Not for use when electric heat installed	EAC180A4* - EAC300A4*, EAC180AW* - EAC300AW*
BAYDSCF301A	Unit Mounted Disconnect, 150 Amp Not for use when electric heat installed	EAC180A3* - EAC300A3*
BAYDSCF302A	Unit Mounted Disconnect, 100 Amp	BAYHTFA318A, BAYHTFA418A, BAYHTFAW18A, BAYHTFA436A, BAYHTFA454A, BAYHTFBW36A, BAYHTFAW54A, BAYHTFBW54A, BAYHTFBW72A, BAYHTFAW72A
BAYDSCF303A	Unit Mounted Disconnect, 150 Amp	BAYHTFA472A, BAYHTF4372A, BAYHTFA336A, BAYHTFB336A, BAYHTFB454A
BAYDSCF304A	Unit Mounted Disconnect, 250 Amp	BAYHTFA372A, BAYHTFB372A, BAYHTFA354A, BAYHTFAW36A
BAYDMPR301A	Damper, Manual	EAC180A* - EAC300A*
BAYDMPR300A	Damper, Motorized	EAC180A* - EAC300A*
BAYECON300A	Economizer, Dry Bulb, Downflow	EAC180A* - EAC300A*
BAYECON301A	Economizer, Dry Bulb, Horizontal	EAC180A* - EAC300A*
BAYECON350A ^③	Low Leak Economizer w/FDD, Dry Bulb, Downflow	EAC180A* - EAC300A*
BAYECON351A	Low Leak Economizer w/FDD, Dry Bulb, Horizontal	EAC180A* - EAC300A*
BAYHZCN300A	Horizontal Economizer Conversion Kit	EAC180A* - EAC300A*
BAYBARO300A	Barometric Relief Damper, 15-25T	EAC180A* - EAC300A*
BAYENTH300A	Reference Enthalpy Economizer Kit	EAC180A* - EAC300A*
BAYENTH301A	Comparative Enthalpy Economizer Kit	EAC180A* - EAC300A*
BAYENTH302A ^③	Reference Enthalpy Economizer Kit	EAC180A* - EAC300A* w/Low Leak Economizer & FDD
BAYENTH303A ^③	Comparative Enthalpy Economizer Kit	EAC180A* - EAC300A* w/Low Leak Economizer & FDD
BAYCURB027B	Roof Curb	EAC180A* - EAC300A*
BAYHZRT001A	Horizontal Duct Conversion Kit	EAC180A* - EAC300A*
BAYCARR001A	Carrier Replacement Conversion Kit	EAC180A* - EAC300A*
BAYGARD300A	Condenser Hail Guard	EAC180A* - EAC300A*
BAYCCHT300A	Crankcase Heater, 70W, 230V	EAC180A3* - EAC300A3*
BAYCCHT301A	Crankcase Heater, 70W, 460V	EAC180A4* - EAC300A4*
BAYCCHT302A	Crankcase Heater, 70W, 575V	EAC180AW* - EAC300AW*
BAYASCT001	Compressor Short Cycle Timer	EAC180A* - EAC300A*
BAYLOAM300A	Low Ambient Control	EAC180A* - EAC300A*
BAYLOAM310A	Evaporator Defrost Control	EAC180A* - EAC300A*
BAYPWRX300A ^①	Power Exhaust, 15-25T, DF, 230V	EAC180A3* - EAC300A3*
BAYPWRX301A ^①	Power Exhaust, 15-25T, DF, 460V	EAC180A4* - EAC300A4*
BAYPWRX302A ^①	Power Exhaust, 15-25T, DF, 575V	EAC180AW* - EAC300AW*
BAYHSMT300A	High Static Motor & Drv, 5HP 230/460V	EAC180A3, EAC180A4
BAYHSMT301A	High Static Motor & Drv, 5HP 575V	EAC180AW
BAYHSMT302A	High Static Motor & Drv, 7.5HP 230/460V	EAC210A3, EAC240A3
BAYHSMT303A	High Static Motor & Drv, 7.5HP 460V	EAC210A4, EAC240A4
BAYHSMT304A	High Static Motor & Drv, 7.5HP 575V	EAC210AW, EAC240AW
BAYSHGR003A ^②	Shaft Grounding Ring, 0.875" Shaft	Used With 5HP VFD Motors
BAYSHGR002A ^②	Shaft Grounding Ring, 1.125" Shaft	Used With 7.5HP VFD Motors
BAYLSDR300A	Low Static Drive Option	EAC180A* - EAC300A*
BAYHSDR300A	High Static Drive Option	EAC180A* - EAC300A*
BAYCO2K300A	Wall Mounted CO2 Sensor	EAC180A* - EAC300A* with economizer
BAYCO2K301A	Duct Mounted CO2 Sensor	EAC180A* - EAC300A* with economizer
BAYPALT001A	Reuseable Pallet for Condenser End Unit Lifting	All Foundation 15-25 Ton Units
BAYCOSW300A	Drain Pan Overflow Switch	EAC180A* - EAC300A*
BAYSTAT300A	BACNet Enabled Thermostat	EAC180A* - EAC300A*

① Please check availability.

② See HVAC Knowledge Center for a list of compatible Carrier units.

③ FDD = Fault Detection & Diagnostics.

Information subject to change. Please confirm with current Product Data for current factory production.

BUILT TO A HIGHER STANDARD[®]

American Standard[®]
HEATING & AIR CONDITIONING

Foundation™ Packaged Cooling 15-25 Tons Heaters

Table LPC-26-A — Foundation™ - R-410A - Field Installed Accessories

Model Number	Power Supply	kW Rating	Nominal BTUH	No. Stages	Used With
BAYHTFA318A	208-230/3/60	13.5/18	46,100/64,400	1	EAC180A3*
BAYHTFA336A	208-230/3/60	27/36	92,200/122,900	2	EAC180A3*, EAC210A3*
BAYHTFB336A	208-230/3/60	27/36	92,200/122,900	2	EAC240A3*, EAC300A3*
BAYHTFA354A	208-230/3/60	40.5/54	138,200/184,300	2	EAC180A3*, EAC210A3*
BAYHTFB354A	208-230/3/60	40.5/54	138,200/184,300	2	EAC240A3*, EAC300A3*
BAYHTFA372A	208-230/3/60	54/72	184,300/245,700	2	EAC210A3*
BAYHTFB372A	208-230/3/60	54/72	184,300/245,700	2	EAC240A3*, EAC300A3*
BAYHTFA418A	460/3/60	18	64,000	1	EAC180A4*
BAYHTFA436A	460/3/60	36	122,900	2	EAC180A4*, EAC210A4*
BAYHTFB436A	460/3/60	36	122,900	2	EAC240A4*, EAC400A4*
BAYHTFA454A	460/3/60	54	184,300	2	EAC180A4*, EAC210A4*
BAYHTFB454A	460/3/60	54	184,300	2	EAC240A4*, EAC400A4*
BAYHTFA472A	460/3/60	72	245,700	2	EAC210A4*
BAYHTFB472A	460/3/60	72	245,700	2	EAC240A4*, EAC400A4*
BAYHTFAW18A	575/3/60	18	64,000	1	EAC180AW*
BAYHTFAW36A	575/3/60	36	122,900	2	EAC180AW*, EAC210AW*
BAYHTFBW36A	575/3/60	36	122,900	2	EAC240AW*, EACW00AW*
BAYHTFAW54A	575/3/60	54	184,300	2	EAC180AW*, EAC210AW*
BAYHTFBW54A	575/3/60	54	184,300	2	EAC240AW*, EACW00AW*
BAYHTFAW72A	575/3/60	72	245,700	2	EAC210AW*
BAYHTFBW72A	575/3/60	72	245,700	2	EAC240AW*, EACW00AW*

Information subject to change. Please confirm with current Product Data for current factory production.

Light Commercial
Packaged Cooling

For complete equipment / combination selections, installation instructions and warranty information, please refer to Product Data/Ratings and/or Installers Guides and Limited Warranty Handbooks.

BUILT TO A HIGHER STANDARD™

American Standard[®]
HEATING & AIR CONDITIONING



Beveled Top
Smoother Design
Small compact cabinet
Recessed access handles

Packaged Heat Pump Convertible 3-10 Tons

Standard Features:

- American Standard Heating & Air Conditioning scroll compressors on all 3-10 ton units
- ReliaTel™ Controls (See page LPC-12 for ReliaTel™ Control Information)
- Thermal Expansion Valve
- Colored and numbered wiring
- Phase Monitor, R-410A, 3 Phase Units
- Provisions for through the Base Condensate Drain Connections
- Crankcase Heaters
- Patented Hybrid Condenser Coil for easy cleaning
- 2" throwaway filters provided on 3-10 ton units
- Liquid Line Refrigerant Drier
- Operating Charge of R-410A
- IAQ Sloped Drain Pans
- Single point power for electric Heat
- Low Ambient cooling to 0°F
- Anti-Short Cycle Timer (Standard with ReliaTel™)
- 5 - year Limited Compressor Warranty
- 1 - year Limited Parts Warranty

Added Flexibility

- **New 3-5 Ton Dual Fuel Models**
- Convertible airflow
- Fork lift openings on three sides of unit
- Direct or belt drive - standard or oversized motors (Direct for 3-5 ton only)
- We don't prepackage options
- Choose options tailored to suit each job —pay only for what is needed
- Units ship with options installed —and within our standard ship cycle time

Factory Installed Options

- Through-the-Base — Electrical
- Convenience Outlet — Powered or unpowered
- Unit Disconnect Switch
- Circuit Breaker
- Smoke Detectors — Supply, return, or both
- Condenser Coil Coating
- Hinged Access Service Panels
- Discharge Air Sensor
- Fan Fail and Clogged Filter Switches
- Condenser Coil Guard — Hail Protection Quality
- Comm 3/4 Communication Interface
- BACnet™ Communications Interface
- Froststat
- 2" MERV 8 filters or 2" MERV 13 filters
- Black Epoxy Pre-Coated Coils
- Multi-Speed & Single Zone VAV ID Airflow
- Demand Control Ventilation
- Stainless Steel Drainpan
- Condensate Drainpan Overflow Switch

The same American Standard Heating & Air Conditioning Quality and Reliability ... with added Flexibility!

For complete equipment / combination selections, installation instructions and warranty information, please refer to Product Data/Ratings and/or Installers Guides and Limited Warranty Handbooks.

LPH-1

Effective 1/1/20
14-1011-37

BUILT TO A HIGHER STANDARD[®]

American Standard[®]
HEATING & AIR CONDITIONING

Packaged Heat Pump Convertible 3-5 Tons

Table LPH-2-A — High Efficiency Unit — ReliaTel™ Microprocessor Controls

Tons	Unit Ordering No.	Performance ^② SEER/HSPF	Cooling Capacity (Btuh)	Cabinet Dimensions (in.) H x D x W	Downflow Supply	Downflow Return	Shipping Weight (lbs.)	MCA*	Max ^① Fuse*
WHC - 208-230/3/60 - Three Phase - No Electric Heat									
3	WHC036H3R0B0000	15.8 / 8.3	40,500	41 x 44 x 69	18 x 15.5	24 x 14	619	23	30
4	WHC048H3R0A0000	16.5 / 8.8	48,750	41 x 53 x 88	33 x 17.5	32 x 17.5	768	29	40
5	WHC060H3R0A0000	16.4 / 9.0	61,000	41 x 53 x 88	33 x 17.5	32 x 17.5	773	32	45
WHC - 460/3/60 - Three Phase - No Electric Heat									
3	WHC036H3R0B0000	15.7 / 8.3	40,500	41 x 44 x 69	18 x 15.5	24 x 14	619	13	15
4	WHC048H3R0A0000	16.5 / 8.8	48,750	41 x 53 x 88	33 x 17.5	32 x 17.5	768	14	15
5	WHC060H3R0A0000	16.2 / 9.0	61,000	41 x 53 x 88	33 x 17.5	32 x 17.5	773	15	20
WHC - 575/3/60 - Three Phase - No Electric Heat									
3	WHC036HWR0B0000	15.7 / 8.3	40,500	41 x 44 x 69	18 x 15.5	24 x 14	619	9	15
4	WHC048HWR0A0000	16.5 / 8.8	48,750	41 x 53 x 88	33 x 17.5	32 x 17.5	768	10	15
5	WHC060HWR0A0000	16.2 / 9.0	61,000	41 x 53 x 88	33 x 17.5	32 x 17.5	773	12	15

Table LPH-2-B — High Efficiency Dual Fuel Unit — ReliaTel™ Microprocessor Controls

Tons	Unit Ordering No.	Performance ^② SEER/HSPF	Cooling Capacity (Btuh)	Gas Heating Output Capacity (Btuh) (2nd / 1st stage)	S.S. Furnace Eff%	Cabinet Dimensions (in.) H x D x W	Downflow Supply	Downflow Return	Shipping Weight (lbs.)	MCA*	Max ^① Fuse*
DHC - 208-230/3/60 - Three Phase - Low Heat											
3	DHC036H3RLB0000	15.7 / 8.3	40,500	48,600 / 34,200	81%	41 x 44 x 69	18 x 15.5	24 x 14	658	23	30
4	DHC048H3RLA0000	16.5 / 8.8	48,750	48,600 / 34,200	81%	41 x 53 x 88	33 x 17.5	32 x 17.5	845	29	40
5	DHC060H3RLA0000	16.2 / 8.9	61,000	48,600 / 34,200	81%	41 x 53 x 88	33 x 17.5	32 x 17.5	849	32	45
DHC - 460/3/60 - Three Phase - Low Heat											
3	DHC036H3RLB0000	15.6 / 8.3	40,500	48,600 / 34,200	81%	41 x 44 x 69	18 x 15.5	24 x 14	658	13	15
4	DHC048H3RLA0000	16.5 / 8.8	48,750	48,600 / 34,200	81%	41 x 53 x 88	33 x 17.5	32 x 17.5	845	14	15
5	DHC060H3RLA0000	16.0 / 8.9	61,000	48,600 / 34,200	81%	41 x 53 x 88	33 x 17.5	32 x 17.5	849	15	20
WHC - 575/3/60 - Three Phase - Low Heat											
3	DHC036HWR0B0000	15.6 / 8.3	40,500	48,600 / 34,200	81%	41 x 44 x 69	18 x 15.5	24 x 14	658	9	15
4	DHC048HWR0A0000	16.5 / 8.8	48,750	48,600 / 34,200	81%	41 x 53 x 88	33 x 17.5	32 x 17.5	845	10	15
5	DHC060HWR0A0000	16.0 / 8.9	61,000	48,600 / 34,200	81%	41 x 53 x 88	33 x 17.5	32 x 17.5	849	12	15
DHC - 208-230/3/60 - Three Phase - Medium Heat											
3	DHC036H3RMB0000	15.7 / 8.3	40,500	64,800 / 45,360	81%	41 x 44 x 69	18 x 15.5	24 x 14	658	23	30
4	DHC048H3RMA0000	16.5 / 8.8	48,750	81,000 / 56,700	81%	41 x 53 x 88	33 x 17.5	32 x 17.5	845	29	40
5	DHC060H3RMA0000	16.2 / 8.9	61,000	81,000 / 58,320	81%	41 x 53 x 88	33 x 17.5	32 x 17.5	849	32	45
DHC - 460/3/60 - Three Phase - Medium Heat											
3	DHC036H3RMB0000	15.6 / 8.3	40,500	64,800 / 45,360	81%	41 x 44 x 69	18 x 15.5	24 x 14	658	13	15
4	DHC048H3RMA0000	16.5 / 8.8	48,750	81,000 / 56,700	81%	41 x 53 x 88	33 x 17.5	32 x 17.5	845	14	15
5	DHC060H3RMA0000	16.0 / 8.9	61,000	81,000 / 58,320	81%	41 x 53 x 88	33 x 17.5	32 x 17.5	849	15	20
DHC - 575/3/60 - Three Phase - Medium Heat											
3	DHC036HWR0B0000	15.6 / 8.3	40,500	64,800 / 45,360	81%	41 x 44 x 69	18 x 15.5	24 x 14	658	9	15
4	DHC048HWR0A0000	16.5 / 8.8	48,750	81,000 / 56,700	81%	41 x 53 x 88	33 x 17.5	32 x 17.5	845	10	15
5	DHC060HWR0A0000	16.0 / 8.9	61,000	81,000 / 58,320	81%	41 x 53 x 88	33 x 17.5	32 x 17.5	849	12	15
DHC - 208-230/3/60 - Three Phase - High Heat											
3	DHC036H3RHB0000	15.7 / 8.3	40,500	81,000 / 56,700	81%	41 x 44 x 69	18 x 15.5	24 x 14	658	23	30
4	DHC048H3RHA0000	16.5 / 8.8	48,750	105,300 / 73,710	81%	41 x 53 x 88	33 x 17.5	32 x 17.5	845	29	40
5	DHC060H3RHA0000	16.2 / 8.9	61,000	121,500 / 85,050	81%	41 x 53 x 88	33 x 17.5	32 x 17.5	849	32	45
DHC - 460/3/60 - Three Phase - High Heat											
3	DHC036H3RHB0000	15.6 / 8.3	40,500	81,000 / 56,700	81%	41 x 44 x 69	18 x 15.5	24 x 14	658	13	15
4	DHC048H3RHA0000	16.5 / 8.8	48,750	105,300 / 73,710	81%	41 x 53 x 88	33 x 17.5	32 x 17.5	845	14	15
5	DHC060H3RHA0000	16.0 / 8.9	61,000	121,500 / 85,050	81%	41 x 53 x 88	33 x 17.5	32 x 17.5	849	15	20
DHC - 575/3/60 - Three Phase - High Heat											
3	DHC036HWR0B0000	15.6 / 8.3	40,500	81,000 / 56,700	81%	41 x 44 x 69	18 x 15.5	24 x 14	658	9	15
4	DHC048HWR0A0000	16.5 / 8.8	48,750	105,300 / 73,710	81%	41 x 53 x 88	33 x 17.5	32 x 17.5	845	10	15
5	DHC060HWR0A0000	16.0 / 8.9	61,000	121,500 / 85,050	81%	41 x 53 x 88	33 x 17.5	32 x 17.5	849	12	15

* Information subject to change. Please confirm with current Product Data/Service Facts for current factory production.

① HCAR breaker per NEC.

② SEER applies, 3-5 tons; HSPF applies 6-10 tons.

For complete equipment / combination selections, installation instructions and warranty information, please refer to Product Data/Ratings and/or Installers Guides and Limited Warranty Handbooks.

LPH-2

Effective 1/1/20

14-1011-37

BUILT TO A HIGHER STANDARD



Packaged Heat Pump Convertible 3-10 Tons

Table LPH-3-A — Base Unit — Standard Efficiency — ReliaTel™ Microprocessor Controls

Tons	Unit Ordering No.	Performance ^② SEER/IEER	Cooling Capacity (Btuh)	Cabinet Dimensions (in.) H x D x W	Downflow Supply	Downflow Return	Shipping Weight (lbs.)	MCA*	Max ^① Fuse*
WHC - 208-230/3/60 - Three Phase - No Electric Heat									
6	WHC074H3R0A0000	15.5	78,900	47 x 53 x 88	33 x 17.5	32 x 17.5	927	42	50
7 1/2	WHC092H3R0A0000	15.5	96,200	47 x 53 x 88	33 x 17.5	32 x 17.5	927	43	50
8 1/2	WHC102H3R0A0000	15.5	105,900	47 x 53 x 88	33 x 17.5	32 x 17.5	953	46	60
10	WHC120H3R0A0000	15.5	123,600	51 x 63 x 100	33 x 17.5	32 x 17.5	1433	49	60
WHC - 460/3/60 - Three Phase - No Electric Heat									
6	WHC074H4R0A0000	15.5	78,900	47 x 53 x 88	33 x 17.5	32 x 17.5	927	19	25
7 1/2	WHC092H4R0A0000	15.5	96,200	47 x 53 x 88	33 x 17.5	32 x 17.5	927	20	25
8 1/2	WHC102H4R0A0000	15.5	105,900	47 x 53 x 88	33 x 17.5	32 x 17.5	953	22	25
10	WHC120H4R0A0000	15.5	123,600	51 x 63 x 100	33 x 17.5	32 x 17.5	1433	24	30
WHC - 575/3/60 - Three Phase - No Electric Heat									
6	WHC074HWROA0000	15.5	78,900	47 x 53 x 88	33 x 17.5	32 x 17.5	927	21	25
7 1/2	WHC092HWROA0000	15.5	96,200	47 x 53 x 88	33 x 17.5	32 x 17.5	927	22	25
8 1/2	WHC102HWROA0000	15.5	105,900	47 x 53 x 88	33 x 17.5	32 x 17.5	953	23	25
10	WHC120HWROA0000	15.5	123,600	51 x 63 x 100	33 x 17.5	32 x 17.5	1433	23	30

Table LPH-3-B — Base Unit — Standard Efficiency — ReliaTel™ Microprocessor Controls

Tons	Unit Ordering No.	Performance ^② SEER/IEER	Cooling Capacity (Btuh)	Gas Heating Output Capacity (Btuh) (2nd / 1st stage)	S.S. Furnace Eff%	Cabinet Dimensions (in.) H x D x W	Downflow Supply	Downflow Return	Shipping Weight (lbs.)	MCA*	Max ^① Fuse*
DHC - 208-230/3/60 - Three Phase - Low Heat											
6	DHC074H3RLA0000	15.5	78,900	64,800	81%	47 x 53 x 88	33 x 17.5	32 x 17.5	990	42	50
7 1/2	DHC092H3RLA0000	15.5	96,200	97,200	81%	47 x 53 x 88	33 x 17.5	32 x 17.5	1004	43	50
8 1/2	DHC102H3RLA0000	15.5	105,900	97,200	81%	47 x 53 x 88	33 x 17.5	32 x 17.5	1016	46	60
10	DHC120H3RLA0000	15.5	123,600	121,500/85,050	81%	51 x 63 x 100	33 x 17.5	32 x 17.5	1499	49	60
DHC - 460/3/60 - Three Phase - Low Heat											
6	DHC074H4RLA0000	15.5	78,900	64,800	81%	47 x 53 x 88	33 x 17.5	32 x 17.5	990	19	25
7 1/2	DHC092H4RLA0000	15.5	96,200	97,200	81%	47 x 53 x 88	33 x 17.5	32 x 17.5	1004	20	25
8 1/2	DHC102H4RLA0000	15.5	105,900	97,200	81%	47 x 53 x 88	33 x 17.5	32 x 17.5	1016	22	25
10	DHC120H4RLA0000	15.5	123,600	121,500/85,050	81%	51 x 63 x 100	33 x 17.5	32 x 17.5	1499	24	30
DHC - 575/3/60 - Three Phase - Low Heat											
6	DHC074HWRLA0000	15.5	78,900	64,800	81%	47 x 53 x 88	33 x 17.5	32 x 17.5	990	21	25
7 1/2	DHC092HWRLA0000	15.5	96,200	97,200	81%	47 x 53 x 88	33 x 17.5	32 x 17.5	1004	22	25
8 1/2	DHC102HWRLA0000	15.5	105,900	97,200	81%	47 x 53 x 88	33 x 17.5	32 x 17.5	1016	23	25
10	DHC120HWRLA0000	15.5	123,600	121,500/85,050	81%	51 x 63 x 100	33 x 17.5	32 x 17.5	1499	23	30
DHC - 208-230/3/60 - Three Phase - Medium Heat											
6	DHC074H3RMA0000	15.5	78,900	97,200	81%	47 x 53 x 88	33 x 17.5	32 x 17.5	990	42	50
7 1/2	DHC092H3RMA0000	15.5	96,200	121,500/85,050	81%	47 x 53 x 88	33 x 17.5	32 x 17.5	1004	43	50
8 1/2	DHC102H3RMA0000	15.5	105,900	121,500/85,050	81%	47 x 53 x 88	33 x 17.5	32 x 17.5	1016	46	60
10	DHC120H3RMA0000	15.5	123,600	162,000/113,400	81%	51 x 63 x 100	33 x 17.5	32 x 17.5	1499	49	60
DHC - 460/3/60 - Three Phase - Medium Heat											
6	DHC074H4RMA0000	15.5	78,900	97,200	81%	47 x 53 x 88	33 x 17.5	32 x 17.5	990	19	25
7 1/2	DHC092H4RMA0000	15.5	96,200	121,500/85,050	81%	47 x 53 x 88	33 x 17.5	32 x 17.5	1004	20	25
8 1/2	DHC102H4RMA0000	15.5	105,900	121,500/85,050	81%	47 x 53 x 88	33 x 17.5	32 x 17.5	1016	22	25
10	DHC120H4RMA0000	15.5	123,600	162,000/113,400	81%	51 x 63 x 100	33 x 17.5	32 x 17.5	1499	24	30
DHC - 575/3/60 - Three Phase - Medium Heat											
6	DHC074HWRLA0000	15.5	78,900	97,200	81%	47 x 53 x 88	33 x 17.5	32 x 17.5	990	21	25
7 1/2	DHC092HWRLA0000	15.5	96,200	121,500/85,050	81%	47 x 53 x 88	33 x 17.5	32 x 17.5	1004	22	25
8 1/2	DHC102HWRLA0000	15.5	105,900	121,500/85,050	81%	47 x 53 x 88	33 x 17.5	32 x 17.5	1016	23	25
10	DHC120HWRLA0000	15.5	123,600	162,000/113,400	81%	51 x 63 x 100	33 x 17.5	32 x 17.5	1499	23	30
DHC - 208-230/3/60 - Three Phase - High Heat											
6	DHC074H3RHA0000	15.5	78,900	121,500/85,050	81%	47 x 53 x 88	33 x 17.5	32 x 17.5	990	42	50
7 1/2	DHC092H3RHA0000	15.5	96,200	162,000/113,400	81%	47 x 53 x 88	33 x 17.5	32 x 17.5	1004	43	50
8 1/2	DHC102H3RHA0000	15.5	105,900	162,000/113,400	81%	47 x 53 x 88	33 x 17.5	32 x 17.5	1016	46	60
10	DHC120H3RHA0000	15.5	123,600	202,500/141,750	81%	51 x 63 x 100	33 x 17.5	32 x 17.5	1499	49	60

① HCAR breaker per NEC.

② SEER applies, 3-5 tons; IEER applies 6-10 tons.

For complete equipment / combination selections, installation instructions and warranty information, please refer to Product Data/Ratings and/or Installers Guides and Limited Warranty Handbooks.

BUILT TO A HIGHER STANDARD[®]

American Standard[®]
HEATING & AIR CONDITIONING

Packaged Heat Pump Convertible 3-10 Tons

Table LPH-4-A — Base Unit — Standard Efficiency — ReliaTel™ Microprocessor Controls (continued)

Tons	Unit Ordering No.	Performance ^② SEER/IEER	Cooling Capacity (Btuh)	Gas Heating Output Capacity (Btuh) (2nd / 1st stage)	S.S. Furnace Eff%	Cabinet Dimensions (in.) H x D x W	Downflow Supply	Downflow Return	Shipping Weight (lbs.)	MCA*	Max ^① Fuse*
DHC - 460/3/60 - Three Phase - High Heat											
6	DHC074H4RHA0000	15.5	78,900	121,500/85,050	81%	47 x 53 x 88	33 x 17.5	32 x 17.5	990	19	25
7 1/2	DHC092H4RHA0000	15.5	96,200	162,000/113,400	81%	47 x 53 x 88	33 x 17.5	32 x 17.5	1004	20	25
8 1/2	DHC102H4RHA0000	15.5	105,900	162,000/113,400	81%	47 x 53 x 88	33 x 17.5	32 x 17.5	1016	22	25
10	DHC120H4RHA0000	15.5	123,600	202,500/141,750	81%	51 x 63 x 100	33 x 17.5	32 x 17.5	1499	24	30
DHC - 575/3/60 - Three Phase - High Heat											
6	DHC074HWRHA0000	15.5	78,900	121,500/85,050	81%	47 x 53 x 88	33 x 17.5	32 x 17.5	990	21	25
7 1/2	DHC092HWRHA0000	15.5	96,200	162,000/113,400	81%	47 x 53 x 88	33 x 17.5	32 x 17.5	1004	22	25
8 1/2	DHC102HWRHA0000	15.5	105,900	162,000/113,400	81%	47 x 53 x 88	33 x 17.5	32 x 17.5	1016	23	25
10	DHC120HWRHA0000	15.5	123,600	202,500/141,750	81%	51 x 63 x 100	33 x 17.5	32 x 17.5	1499	23	30

Table LPH-4-B — Base Unit — Standard Efficiency — ReliaTel™ Microprocessor Controls

Tons	Unit Ordering No.	Performance ^② SEER/IEER	Cooling Capacity (Btuh)	Cabinet Dimensions (in.) H x D x W	Downflow Supply	Downflow Return	Shipping Weight (lbs.)	MCA*	Max ^① Fuse*
WSC - 208-230/3/60 - Three Phase - No Electric Heat									
3	WSC036H3R0A0000	14.0	39,500	41 x 44 x 69	18 x 15.5	24 x 14	612	26	40
4	WSC048H3R0A0000	14.0	50,000	41 x 44 x 69	18 x 15.5	24 x 14	645	27	40
5	WSC060H3R0A0000	14.0	61,000	41 x 53 x 88	33 x 17.5	32 x 17.5	777	31	45
6	WSC072H3R0A0000	12.2	78,000	47 x 53 x 88	33 x 17.5	32 x 17.5	835	35	50
7 1/2	WSC090H3R0A0000	12.2	93,500	47 x 53 x 88	33 x 17.5	32 x 17.5	902	38	60
7 1/2	WSC092H3R0A0000	12.2	95,300	47 x 53 x 88	33 x 17.5	32 x 17.5	894	40	60
8 1/2	WSC102H3R0A0000	12.2	103,200	47 x 53 x 88	33 x 17.5	32 x 17.5	927	45	70
10	WSC120H3R0A0000	12.2	118,100	47 x 53 x 88	33 x 17.5	32 x 17.5	948	54	80
WSC - 460/3/60 - Three Phase - No Electric Heat									
3	WSC036H3R0A0000	14.0	39,500	41 x 44 x 69	18 x 15.5	24 x 14	612	11	15
4	WSC048H3R0A0000	14.0	50,000	41 x 44 x 69	18 x 15.5	24 x 14	645	12	15
5	WSC060H3R0A0000	14.0	61,000	41 x 53 x 88	33 x 17.5	32 x 17.5	777	15	20
6	WSC072H4R0A0000	12.2	78,000	47 x 53 x 88	33 x 17.5	32 x 17.5	835	17	25
7 1/2	WSC090H4R0A0000	12.2	93,500	47 x 53 x 88	33 x 17.5	32 x 17.5	902	19	30
7 1/2	WSC092H4R0A0000	12.2	95,300	47 x 53 x 88	33 x 17.5	32 x 17.5	894	18	25
8 1/2	WSC102H4R0A0000	12.2	103,200	47 x 53 x 88	33 x 17.5	32 x 17.5	927	20	30
10	WSC120H4R0A0000	12.2	118,100	47 x 53 x 88	33 x 17.5	32 x 17.5	948	24	35
WSC - 575/3/60 - Three Phase - No Electric Heat									
3	WSC036HWR0A0000	14.0	39,500	41 x 44 x 69	18 x 15.5	24 x 14	612	11	15
4	WSC048HWR0A0000	14.0	50,000	41 x 44 x 69	18 x 15.5	24 x 14	645	12	15
5	WSC060HWR0A0000	14.0	61,000	41 x 53 x 88	33 x 17.5	32 x 17.5	777	13	15
6	WSC072EWR0A0000	12.2	78,000	47 x 53 x 88	33 x 17.5	32 x 17.5	835	13	20
7 1/2	WSC090HWR0A0000	12.2	93,500	47 x 53 x 88	33 x 17.5	32 x 17.5	902	15	20
7 1/2	WSC092H4R0A0000	12.2	95,300	47 x 53 x 88	33 x 17.5	32 x 17.5	894	14	20
8 1/2	WSC102H4R0A0000	12.2	103,200	47 x 53 x 88	33 x 17.5	32 x 17.5	927	16	20
10	WSC120HWR0A0000	12.2	118,100	47 x 53 x 88	33 x 17.5	32 x 17.5	948	23	30

① HCAR breaker per NEC.

② SEER applies, 3-5 tons; IEER applies 6-10 tons.

Light Commercial
Packaged Heat Pumps

For complete equipment / combination selections, installation instructions and warranty information, please refer to Product Data/Ratings and/or Installers Guides and Limited Warranty Handbooks.

Packaged Heat Pump Convertible 3-10 Tons (Model Digit Numbers)

Digit	Description	Order Number	Digit	Description	Order Number
1-8	Main Assembly (see previous page)		21	Communications Options	
9	Unit Controls			No Communications Interface.....	0
	ReliaTel™ Micro-processor.....	R		BACnet™ Communications Interface	6
10	(See Heater Table below)		22	Refrigeration System Option	
11	Minor Design Sequence			Standard Refrigeration System®	0
	First Sequence	A	23	Refrigeration Controls	
12-13	Service Sequence			No Refrigeration Control③.....	0
	First Sequence (Factory Assigned).....	*.*		Froststat®.....	1
14	Fresh Air Selection		24	Smoke Detector	
	No Fresh Air.....	0		No Smoke Detector	0
	Manual Outside Air Damper 0-50%②.....	A		Return Air Smoke Detector⑨.....	A
	Motorized Outside Air Damper 0-50%②.....	B		Supply Air Smoke Detector.....	B
	Economizer, Dry Bulb 0-100% without			Supply and Return Air Smoke Detectors⑨.....	C
	Barometric Relief⑤.....	C		Plenum Smoke Detector.....	D
	Economizer, Dry Bulb 0-100% with		25	System Monitoring Controls	
	Barometric Relief⑤.....	D		No Monitoring Control.....	0
	Economizer, Reference Enthalpy 0-100%			Clogged Filter Switch.....	1
	without Barometric Relief⑤.....	E		Fan Failure Switch.....	2
	Economizer, Reference Enthalpy 0-100%			Discharge Air Sensing Tube.....	3
	with Barometric Relief⑤.....	F		Clogged Filter Switch and Fan Fail Switch.....	4
	Economizer, Comparative Enthalpy 0-100%			Clogged Filter Switch and Discharge Air	
	without Barometric Relief⑤.....	G		Sensing Tube.....	5
	Economizer, Comparative Enthalpy 0-100%			Fan Fail Switch and Discharge Air Sensing Tube.....	6
	with Barometric Relief⑤.....	H		Clogged Filter and Fan Fail Switches and	
	Low Leak Economizer, Dry Bulb			Discharge Air Sensing Tube.....	7
	with Barometric Relief.....	K		Condensate Drain Pan Overflow Switch.....	A
	Low Leak Economizer, Comparative Enthalpy			Clogged Filter Switch and Condensate Drain	
	with Barometric Relief.....	M		Pan Overflow Switch.....	B
	Low Leak Economizer, Reference Enthalpy			Fan Failure Switch and Condensate Drain	
	with Barometric Relief.....	P		Pan Overflow Switch.....	C
15	Supply Fan/Drive Type/Motor			Discharge Air Sensing and Condensate Drain	
	Standard Drive④.....	0		Pan Overflow Switch.....	D
	Oversized Motor.....	1		Clogged Filter Switch, Fan Failure Switch and	
	Optional Belt Drive Motor.....	2		Condensate Drain Pan Overflow Switch.....	E
	Single Zone Variable Air Volume (SZVAV).....	6		Clogged Filter Switch, Discharge Air Sensing Tube	
	Multi-Speed Indoor Fan⑭.....	7		and Condensate Drain Pan Overflow Switch.....	F
16	Hinged Service Access/Filters			Fan Failure Switch, Discharge Air Sensing Tube	
	Standard Panels/Standard Filters.....	0		and Condensate Drain Pan Overflow Switch.....	G
	Hinged Access Panels/Standard Filters.....	A		Clogged Filter Switch, Fan Failure Switch,	
	Standard Panels/2" MERV 8 Filters.....	B		Discharge Air Sensing and Condensate	
	Hinged Access Panels/2" MERV 8 Filters.....	C		Drain Pan Overflow Switch.....	H
	Standard Panels/2" MERV 13 Filters.....	D	26	System Monitoring Controls	
	Hinged Access Panels/2" MERV 13 Filters.....	E		No Monitoring Controls.....	0
17	Condenser Coil Protection			Demand Control Ventilation (CO ₂)⑩.....	A
	Standard Coil.....	0		Fault Detection and Diagnostics (FDD).....	B
	Standard Coil with Hail Guard.....	1		Fault Detection and Diagnostics (FDD)	
	Black Epoxy Pre-Coated Condenser Coil.....	2		with Demand Control Ventilation.....	C
	Black Epoxy Pre-Coated Condenser Coil		27	Unit Hardware Enhancements	
	with Hail Guard.....	3		No Enhancements.....	0
18	Through the Base Provisions			Stainless Steel Drain Pan.....	1
	No Through the Base Provisions.....	0	31	Advanced Unit Controls	
	Through the Base Electric⑥.....	A		Standard Unit Controls.....	0
19	Disconnect/Circuit Breaker (three-phase only)			Human Interface.....	1
	No Disconnect/No Circuit Breaker.....	0			
	Unit Mounted Non-Fused Disconnect⑥.....	1			
	Unit Mounted Circuit Breaker⑥.....	2			
20	Convenience Outlet				
	No Convenience Outlet.....	0			
	Unpowered Convenience Outlet.....	A			
	Powered Convenience Outlet (three-phase only)⑦.....	B			

① Available on 3-5 ton models.
 ② Manual outside air damper will ship factory supplied within the unit, but must be field installed.
 ③ High pressure control is standard on all units.
 ④ Multispeed direct drive standard on single-phase products. Belt drive standard on three-phase 3-7½ ton. Variable speed direct drive standard on 10 ton.
 ⑤ Economizer with Barometric Relief is for downflow configured units only. Order Economizer without Barometric Relief for horizontal configuration. Barometric Relief for horizontal configured units must be ordered as field installed accessory.
 ⑥ Through the base electric required when ordering disconnect/circuit breaker options.
 ⑦ Requires use of Disconnect or Circuit Breaker.
 ⑧ Standard metering devices are TXVs.
 ⑨ The return air smoke detector may not fit up or work properly on the Precedent units when used in conjunction with 3rd party accessories such as bolt on heat wheels, economizers and power exhaust. Do not order the return air smoke detectors when using this type of accessory.
 ⑩ Requires hinged access panels.
 ⑪ Crankcase heaters are only available as option on WSC036E, WSC048E1, & WSC060E1. CCH are standard on all other units.
 ⑫ Motorized outside air damper is not available on Multi-Speed or SZVAV (Single Zone Variable Air Volume) products.
 ⑬ Froststat standard on Multi-speed and SZVAV (Single Zone Variable Air Volume) products.
 ⑭ Multi-speed indoor fan only available on 10 ton products.
 ⑮ Demand Control Ventilation Option includes wiring only. The CO₂ sensor is a field-installed only option.

BUILT TO A HIGHER STANDARD™

American Standard
HEATING & AIR CONDITIONING

Packaged Heat Pump Convertible 3-10 Tons (Model Digit Numbers)

Heaters (Digit 10)

kW Rating	Digit	Nominal BTUH	No. Stages	Used With
208/240/3/60				
4.5/6.0	(B)	13,400/20,500	1	WSC036-060H3, WHC036-060H3
9.0/12.0	(E)	30,800/59,400	2	WSC036-060H3, WHC036-060H3
13.1/17.4	(G)	44,600/59,400	2	WSC036-060H3, WHC036-060H3
17.3/23.0	(J)	58,900/78,500	2	WSC060H3, WHC060H3
6.75/9.0	(C)	23,000/30,700	1	WSC072-102H3, WHC074-102H3
13.5/18.0	(G)	46,100/61,400	1	WSC072-102H3, WHC074-102H3
20.3/27.0	(K)	69,000/92,100	2	WSC072-102H3, WHC074-102H3
27.0/36.0	(N)	92,200/122,900	2	WSC072-102H3, WHC074-102H3
40.5/54.0	(P)	138,200/184,300	2	WSC120H3, WHC120H3
460/3/60				
6.0	(B)	20,500	1	WSC036-060H4, WHC036-060H4
12.0	(E)	41,000	2	WSC036-060H4, WHC036-060H4
17.4	(G)	59,400	2	WSC036-060H4, WHC036-060H4
23.0	(J)	78,500	2	WSC060H4, WHC060H4
9.0	(C)	30,700	1	WSC072-102H4, WHC074-102H4
18.0	(G)	61,400	1	WSC072-102H4, WHC074-102H4
27.0	(K)	92,100	2	WSC072-102H4, WHC074-102H4
36.0	(N)	122,900	2	WSC072-102H4, WHC074-102H4
54.0	(P)	184,300	2	WSC120H4, WHC120H4
575/3/60				
6.0	(B)	20,500	1	WSC036-060HW, WHC036-060HW
12.0	(E)	41,000	2	WSC036-060HW, WHC036-060HW
17.4	(G)	59,400	2	WSC036-060HW, WHC036-060HW
23.0	(J)	78,500	2	WSC060HW, WHC060HW
9.0	(C)	30,700	1	WSC072-102HW, WHC074-102HW
18.0	(G)	61,400	1	WSC072-102HW, WHC074-102HW
27.0	(K)	92,100	2	WSC072-102HW, WHC074-102HW
36.0	(N)	122,900	2	WSC072-102HW, WHC074-102HW
54.0	(P)	184,300	2	WSC120HW, WHC120HW

Digit 15 Selection Details

Digit 15 = 0

Standard Efficiency

- 3 Phase (3 to 5 Ton) = Multispeed Direct Drive Motor
- 3 Phase (6 to 8.5 Ton) = Belt Drive
- 3 Phase (10 Ton) = Ultra High Efficiency Direct Drive Plenum Fan

High Efficiency

- 1 Phase = High Efficiency Multispeed Direct Drive Motor
- 3 Phase (3 to 5 ton) = High Efficiency Multispeed Direct Drive Motor
- 3 Phase (3 to 5 ton w/Dehumidification) = Belt Drive Motor
- 3 Phase [6 (074) to 10 ton] = Ultra High Efficiency Direct Drive Plenum Fan

Digit 15 = 2

Standard Efficiency

- 3 Phase = Not Available

High Efficiency

- 1 Phase = Not Available

BUILT TO A HIGHER STANDARD™

American Standard
HEATING & AIR CONDITIONING

Packaged Heat Pump Convertible 3-5 Tons, Electric Heaters

Table LPH-7-A — Accessory Electric Heaters – Unit with Heater is single circuit / single point power entry (3-5 Ton units)

Model Number	Power Supply	kW Rating	Nominal BTUH	No. Stages	Used With
BAYHTRE306C	208-230/3/60	4.5/6.0	13,400/20,500	1	WHC036H3, WSC036-048H3
BAYHTRE312C	208-230/3/60	9.0/12.0	30,800/41,000	2	WHC036H3, WSC036-048H3
BAYHTRE406C	460/3/60	6	20500	1	WHC036H4, WSC036-048H4
BAYHTRE412C	460/3/60	12	41000	2	WHC036H4, WSC036-048H4
BAYHTREW06C	575/3/60	6	20500	1	WHC036HW, WSC036-048HW
BAYHTREW12C	575/3/60	12	41000	2	WHC036HW, WSC036-048HW
BAYHTRX306B	208-230/3/60	4.5/6.0	13,400/20,500	1	WHC048-060H3, WSC060H3
BAYHTRX312B	208-230/3/60	9.0/12.0	30,800/41,000	2	WHC048-060H3, WSC060H3
BAYHTRX406B	460/3/60	6	20500	1	WHC048-060H3, WSC060H4
BAYHTRX412B	460/3/60	12	41000	2	WHC048-060H3, WSC060H4
BAYHTRXW06B	575/3/60	6	20500	1	WHC048-060HW, WSC060HW
BAYHTRXW12B	575/3/60	12	41000	2	WHC048-060HW, WSC060HW
BAYHTRY317A	208-230/1/60	13.1/17.4	44,600/59,400	2	WHC036H3, WSC036-048H3
BAYHTRY318A	208-230/1/60	13.1/17.4	44,600/59,400	2	WHC048-060H3, WSC060H3
BAYHTRY323A	208-230/1/60	17.3/23.0	59,000/78,500	2	WHC060H3, WSC060H3
BAYHTRY417A	460/3/60	17.4	59400	2	WHC036H4, WSC036-048H4
BAYHTRY418A	460/3/60	17.4	59400	2	WHC048-060H4, WSC060H4
BAYHTRY423A	460/3/60	23	78500	2	WHC060H4, WSC060H4
BAYHTRYW17A	575/3/60	17.4	59400	2	WHC036HW, WSC036-048HW
BAYHTRYW18A	575/3/60	17.4	59400	2	WHC048-060HW, WSC060HW
BAYHTRYW23A	575/3/60	23	78500	2	WHC060HW, WSC060HW

For complete equipment / combination selections, installation instructions and warranty information, please refer to Product Data/Ratings and/or Installers Guides and Limited Warranty Handbooks.

LPH-7

Effective 1/1/20
14-1011-37

BUILT TO A HIGHER STANDARD™

American Standard
HEATING & AIR CONDITIONING

Packaged Heat Pump Convertible 6-10 Tons, Electric Heaters and Zone Sensors

Table LPH-8-A — Accessory Electric Heaters – Unit with Heater is single circuit / single point power entry (6 - 8 1/2 Ton units)

Model Number	Power Supply	kW Rating	Nominal BTUH	No. Stages	Used With
BAYHTRW309A	208-230/3/60	6.8/9.0	23,000/30,700	1	WSC072H3
BAYHTRW318A	208-230/3/60	13.5/18.0	46,100/61,400	1	WSC072H3
BAYHTRW327A	208-230/3/60	20.3/27.0	69,000/92,100	2	WSC072H3
BAYHTRW336A	208-230/3/60	27.0/36.0	92,100/122,900	2	WSC072H3
BAYHTRW409A	460/3/60	9	30700	1	WSC072H4
BAYHTRW418A	460/3/60	18	61400	1	WSC072H4
BAYHTRW427A	460/3/60	27	92100	2	WSC072H4
BAYHTRW436A	460/3/60	36	122900	2	WSC072H4
BAYHTRWW18A	575/3/60	18	61400	1	WSC072HW
BAYHTRWW27A	575/3/60	27	92100	2	WSC072HW
BAYHTRWW36A	575/3/60	36	122900	2	WSC072HW
BAYHTRU309A	208-230/3/60	6.8/9.0	23,000/30,700	1	WSC090H3, WSC092H3, WSC102H3
BAYHTRU318A	208-230/3/60	13.5/18.0	46,100/61,400	1	WSC090H3, WSC092H3, WSC102H3
BAYHTRU327A	208-230/3/60	20.3/27.0	69,000/92,100	2	WSC090H3, WSC092H3, WSC102H3
BAYHTRU336A	208-230/3/60	27.0/36.0	92,100/122,900	2	WSC090H3, WSC092H3, WSC102H3
BAYHTRU409A	460/3/60	9	30700	1	WSC090H4, WSC092H4, WSC102H4
BAYHTRU418A	460/3/60	18	61400	1	WSC090H4, WSC092H4, WSC102H4
BAYHTRU427A	460/3/60	27	92100	2	WSC090H4, WSC092H4, WSC102H4
BAYHTRU436A	460/3/60	36	122900	2	WSC090H4, WSC092H4, WSC102H4
BAYHTRUW18A	575/3/60	18	61400	1	WSC090HW, WSC092HW, WSC102HW
BAYHTRUW27A	575/3/60	27	92100	2	WSC090HW, WSC092HW, WSC102HW
BAYHTRUW36A	575/3/60	36	122900	2	WSC090HW, WSC092HW, WSC102HW

Table LPH-8-B — Accessory Electric Heaters - Unit with Heater is single circuit / single point power entry (Select 7 1/2 - 8 1/2 Ton, All 10 Ton units)

Model Number	Power Supply	kW Rating	Nominal BTUH	No. Stages	Used With
BAYHTRB318A	208-230/3/60	13.5/18.0	46,100/61,400	1	WHC120H3
BAYHTRB327A	208-230/3/60	20.3/27.0	69,000/92,100	2	WHC120H3
BAYHTRB336A	208-230/3/60	27.0/36.0	92,100/122,900	2	WHC120H3
BAYHTRB354A	208-230/3/60	40.6/54.0	138,000/184,300	2	WHC120H3
BAYHTRB418A	460/3/60	18	61400	1	WHC120H4
BAYHTRB427A	460/3/60	27	92100	2	WHC120H4
BAYHTRB436A	460/3/60	36	122900	2	WHC120H4
BAYHTRB454A	460/3/60	54	184300	2	WHC120H4
BAYHTRBW18A	575/3/60	18	61400	1	WHC120HW
BAYHTRBW36A	575/3/60	36	122900	2	WHC120HW
BAYHTRBW54A	575/3/60	54	184300	2	WHC120HW
BAYHTRA309A	208-230/3/60	6.8/9.0	23,000/30,700	1	WSC092H3Ⓞ, WSC102H3Ⓞ, WHC074-102H3
BAYHTRA318A	208-230/3/60	13.5/18.0	46,100/61,400	1	WSC092H3Ⓞ, WSC102H3Ⓞ, WHC074-102H3
BAYHTRA327A	208-230/3/60	20.3/27.0	69,000/92,100	2	WSC092H3Ⓞ, WSC102H3Ⓞ, WHC074-102H3
BAYHTRA336A	208-230/3/60	27.0/36.0	92,100/122,900	2	WSC092H3Ⓞ, WSC102H3Ⓞ, WHC074-102H3
BAYHTRA354A	208-230/3/60	40.6/54.0	138,000/184,300	2	WSC120H3
BAYHTRA409A	460/3/60	9	30700	1	WSC092H4Ⓞ, WSC102H4Ⓞ, WHC074-102H4
BAYHTRA418A	460/3/60	18	61400	1	WSC092H4Ⓞ, WSC102H4Ⓞ, WHC074-102H4
BAYHTRA427A	460/3/60	27	92100	2	WSC092H4Ⓞ, WSC102H4Ⓞ, WHC074-102H4
BAYHTRA436A	460/3/60	36	122900	2	WSC092H4Ⓞ, WSC102H4Ⓞ, WHC074-102H4
BAYHTRA454A	460/3/60	54	184300	2	WSC120H4
BAYHTRAW18A	575/3/60	18	61400	1	WSC092HWⓄ, WSC102HWⓄ, WHC074-102HW
BAYHTRW27A	575/3/60	27	92100	2	WSC092HWⓄ, WSC102HWⓄ, WSC120HW, WHC074-102HW
BAYHTRAW36A	575/3/60	36	122900	2	WSC092HWⓄ, WSC102HWⓄ, WSC120HW, WHC074-102HW
BAYHTRAW54A	575/3/60	54	184300	2	WSC120H4W

Ⓞ Used when Single Zone VAV (SZVAV) or Multi Speed options are selected (digit 15=6 or 7 in model number)

For complete equipment / combination selections, installation instructions and warranty information, please refer to Product Data/Ratings and/or Installers Guides and Limited Warranty Handbooks.

Light Commercial
Packaged Heat Pumps

Packaged Heat Pump Convertible 3-10 Tons Accessories

Table LPH-9-A — Accessories

Model Number	Description	Used With
BAYABRD001C4	ReliaTel™ Options Module	All Precedents, See Note④
BAYBARM010A②	Barometric Relief	WSC036-048H, WHC036H, DHC036H
BAYBARM011A②	Barometric Relief	WSC060-120H, WHC048-120H, DHC048-120H
BAYCO2K001B	CO2 Sensor Kit, Wall Mounted	All Precedents
BAYCO2K003B	CO2 Sensor Kit, Duct Mounted	All Precedents
BAYCURB042A③	Roof Curb	WSC036-048H, WHC036H, DHC036H
BAYCURB043A③	Roof Curb	WSC060-120H, WHC048-102H, DHC048-102H
BAYCURB044A③	Roof Curb	WHC120H, DHC120H
BAYDFPS003B④	Clogged Filter Switch (w/Standard & MERV 8 Filter)	All Precedents
BAYDFPS014A④	Clogged Filter Switch (MERV 13 Filter)	All Precedents
BAYDFPS004A④	Fan Failure Switch	All Precedents
BAYDMPR053B⑥	0-50% Manual Outside Air Damper	WSC036-048H, WHC036H, DHC036H
BAYDMPR056B⑥	0-50% Manual Outside Air Damper	WSC060-120H, WHC048-120H, DHC048-120H
BAYDMPR051A	0-50% Motorized Outside Air Damper	WSC036-048H, WHC036H, DHC036H
BAYDMPR054A	0-50% Motorized Outside Air Damper	WSC060-120H, WHC048-120H, DHC048-120H
BAYECON085A	0-100% Economizer without Barometric Relief	WSC036-048H, WHC036H, DHC036H
BAYECON087A	0-100% Economizer without Barometric Relief	WSC060-120H, WHC048-120H, DHC048-120H
BAYECON704A	Downflow Low Leak Economizer	WSC060-120H, WHC048-120H, DHC048-120H
BAYECON705B	Downflow Low Leak Economizer	WSC036-048H, WHC036H, DHC036H
BAYENTH005A①	Reference Enthalpy Kit	BAYECON085A, 087A
BAYENTH006B①	Comparative Enthalpy Kit	BAYECON085A, 087A
BAYFRST003A⑤	High Temperature Stat	All Precedents
BAYGARD437A	Condenser Coil Hail Guard	WSC036-048H, WHC036H, DHC036H
BAYGARD240A	Condenser Coil Hail Guard	WSC060-072H, WHC048-060, DHC048-060H
BAYGARD241A	Condenser Coil Hail Guard	WSC090-120H, WHC074-102H, DHC074-102H
BAYGARD270A	Condenser Coil Hail Guard	DHC120H, WHC120H
BAYHAKT011*	High Altitude Gas Kit	DHC036-060H3/4/W
BAYHATK010*	High Altitude Gas Kit	DHC074-120H3/4/W

① Kits contain all necessary parts to achieve desired level of enthalpy control.

② Barometric Relief accessory installs in ductwork for horizontal configuration. For downflow configuration, installs on the unit's horizontal return duct. Panel see Installer's Guide for complete instructions.

③ Lynn Haven manufacturing has a no return policy for this roof curb.

④ BAYABRD001C is required when ordering field installed accessories Clogged Filter Switch (BAYDFPS003A), Fan Fail Switch (BAYDFPS004A), Discharge Air Sensing Kit (BAYTUBE005A or BAYTUBE007A) or Evaporator Defrost Control (Frostat) (BAYLOAM020B) Ventilation Override Kit (BAYVNOR001B) unless the following options are factory installed: Frostat, Smoke Detector, Clogged Filter Switch, Fan Failure Switch, Discharge Air Sensing Kit. These factory installed options include the ReliaTel™ Options Module.

⑤ Cannot be used in conjunction with factory installed smoke detector.

⑥ The manual outside air damper will ship factory supplied within the unit, but must be field installed.

Packaged Heat Pump Convertible 3-10 Tons Accessories

Table LPH-10-A — Accessories

Model Number	Description	Used With
BAYHSMT403A	2 HP Belt Drive Oversized Motor	WSC072H3/H4
BAYHSMT404A	2 HP Belt Drive Oversized Motor	WSC072HW
BAYHSMT400A	3 HP Belt Drive Oversized Motor	WSC090H3/4, WSC092H3/4, WSC102H3/4
BAYHSMT401A	3 HP Belt Drive Oversized Motor	WSC090HW, WSC092HW, WSC102HW
BAYLSDR009A	Low Static Drive	WSC090H
BAYICSI003A ^⑤	Trane Communications Interface (TCI)	All Precedents
BAYLOAM020B ^④	Evaporator Defrost Control (Frostat)	All Precedents
BAYLPKT050*	Single Stage Gas LP Kit	DHC074H**(L,X,M,Y), DHC(092/102)H**(L,X)
BAYHATK010*	Dual Stage Gas LP Kit Hight Altitude Gas Kit	DHC074H(3,4,W)*(H,Z), DHC(092/102)H(3,4,W)*(M,Y,H,Z), DHC120H(3,4,W)*(L,X,M,Y,H,Z)
BAYLTCI002B ^⑦	LonTalk [®] Communications Interface (LCI)	All Precedents
BAYPWRX070A	Power Exhaust (208-230/3)	WSC036-048H3, WHC036H3, DHC036H3
BAYPWRX071A	Power Exhaust (460/3)	WSC036-048H4, WHC036H4, DHC036H4
BAYPWRX072A	Power Exhaust (575/3)	WSC036-048HW, WHC036HW, DHC036HW
BAYPWRX026A ^⑥	Power Exhaust (208-230/3)	WSC060-120H3, WHC048-120H3, DHC048-120H3
BAYPWRX027A ^⑥	Power Exhaust (460/3)	WSC060-120H4, WHC048-120H4, DHC048-120H4
BAYPWRX028A ^⑥	Power Exhaust (575/3)	WSC060-120H4, WHC048-120H4, DHC048-120H4
BAYQACB009A ^{②③}	Quick Adapt Roof Curb	WSC036-048H, WHC036H, DHC036H
BAYQACB010A ^{②③}	Quick Adapt Roof Curb	WSC036-048H, WHC036H, DHC036H
BAYQACB011A ^{②③}	Quick Adapt Roof Curb	WSC060-120H, WHC048-102H, DHC048-120H
BAYQACB012A ^{②③}	Quick Adapt Roof Curb	WSC060-120H, WHC048-102H, DHC048-120H
BAYQACB013A ^{②③}	Quick Adapt Roof Curb	WSC060-120H, WHC048-102H, DHC048-120H
BAYQACB111A ^{②③}	Quick Adapt Roof Curb	WHC120H, DHC120H
BAYQACB112A ^{②③}	Quick Adapt Roof Curb	WHC120H, DHC120H
BAYQACB113A ^{②③}	Quick Adapt Roof Curb	WHC120H, DHC120H
BAYQACB114A ^{②③}	Quick Adapt Roof Curb	WSC060-120H, WHC048-102H, DHC048-120H
BAYQACB115A ^{②③}	Quick Adapt Roof Curb	WSC060-120H, WHC048-102H, DHC048-120H

- ① Used for true discharge air sensing in both heating and cooling. Required for supply air tempering.
- ② Lynn Haven manufacturing has a no return policy for this roof curb.
- ③ BAYQACB009A adapts Voyager BAYCURB021A roof curb to accept Precedent 3-5 ton unit. BAYQACB010A adapts Voyager BAYCURB022A roof curb to accept Precedent 3-5 ton unit. BAYQACB111A adapts Voyager BAYCURB022 roof curb to accept WSC120E. BAYQACB112A adapts Voyager BAYCURB025 roof curb to accept WSC120E. BAYQACB113A adapts Voyager BAYCURB026 roof curb to accept WSC120E.
- ④ BAYABRD001C is required when ordering field installed accessories Clogged Filter Switch (BAYDFPS003A), Fan Fail Switch (BAYDFPS004A), Discharge Air Sensing Kit (BAYTUBE005A or BAYTUBE007A) or Evaporator Defrost Control (Frostat) (BAYLOAM020B) Ventilation Override Kit (BAYVNOR001B) unless the following options are factory installed: Frostat, Smoke Detector, Clogged Filter Switch, Fan Failure Switch, Discharge Air Sensing Kit. These factory installed options include the ReliaTel™ Options Module.
- ⑤ Interface allows unit to communicate with Tracer 100, Tracker, VariTrac II, and is the preferred method of communication to Tracer Summit.
- ⑥ Power Exhaust cannot be used with Barometric Relief. Order Economizer without Barometric Relief.
- ⑦ Interface allows unit to communicate as a Trane LonTalk[®] device or directly with generic LonTalk[®] Network BAS Controls.
- ⑧ BAYQACB012A adapts Voyager BAYCURB025 roof curb to accept Precedent 6-10 ton unit. BAYQACB011A adapts Voyager BAYCURB022B roof curb to accept Precedent 6-10 ton unit. BAYQACB adapts Voyager BAYCURB026 roof curb to accept WSC060-090E.
- ⑨ Field installed accessory. Requires an economizer.
- ⑩ If any version of comparative or reference enthalpy is ordered, BAYRTEM001A does not need to be ordered.
- ⑪ Order only when unit has factory installed Demand Control Ventilation option.
- ⑫ Precedent E cabinet to Precedent D cabinet (BAYCURB044 to BAYCURB043)
- ⑬ Precedent B cabinet to Precedent C cabinet (BAYCURB042 to BAYCURB043)

Light Commercial
Packaged Heat Pumps

For complete equipment / combination selections, installation instructions and warranty information, please refer to Product Data/Ratings and/or Installers Guides and Limited Warranty Handbooks.

Packaged Heat Pump with ReliaTel™ Controls 12½-20 Tons

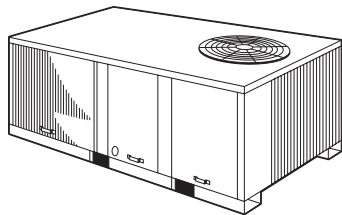

12½ – 20 Ton WSD—Downflow
12½ – 20 Ton WSH—Horizontal

- EER up to 10.6
- **ReliaTel™** processor control features are listed on page LPC-12
- Built-in anti-short cycle, time-delay relay and minimum on time controls
- 2" filters for 12½ - 20 ton units
- Liquid line drier
- Built-in fork lift holes
- Operating charge of R-410A
- Quick-Session service panels slide in and out
- Scroll compressors
- Dedicated horizontal and downflow designs
- Single-side access
- Single point power for electric heat
- Complete line of optional electric heaters
- Internally enhanced coil tubing
- Low ambient to 0°F standard
- Colored and numbered wiring
- Common cabinet and accessories Cooling only and Gas/Electric Heat models
- Quick-adjust idler arm pulley
- **5-year limited compressor warranty (12½ – 20 tons)**

Table LPH-11-A — Standard — ReliaTel™ Units (R-410A)

Tons	Unit Model No.	Power Supply Volts/Phase/Hz	Performance IEER	Cooling Capacity (Btuh)	Dimensions (in.) H x W x L	Shipping Weight (lbs.)	MCA ^⑤	Max Fuse Size or ^④ Max Circuit Breaker	Downflow Roofcurb
12 ½	WS*150E3R0B0000	208-230/3/60	12.0	146,000	56 ⅞ x 84 ⅜ x 121 ⅞	2455	67.0	80	BAYCURB027B
15	WS*180E3R0B0000	208-230/3/60	12.0	177,000	56 ⅞ x 84 ⅜ x 121 ⅞	2459	73.0	90	BAYCURB027B
20	WS*240E3R0B0000	208-230/3/60	11.5	240,000	66 ¼ x 84 ⅜ x 121 ⅞	2641	113.0	150	BAYCURB027B
12 ½	WS*150E4R0B0000	460/3/60	12.0	146,000	56 ⅞ x 84 ⅜ x 121 ⅞	2455	32.0	40	BAYCURB027B
15	WS*180E4R0B0000	460/3/60	12.0	177,000	56 ⅞ x 84 ⅜ x 121 ⅞	2459	36.0	45	BAYCURB027B
20	WS*240E4R0B0000	460/3/60	11.5	240,000	66 ¼ x 84 ⅜ x 121 ⅞	2641	53.0	70	BAYCURB027B
12 ½	WS*150EWR0B0000	575/3/60	12.0	146,000	56 ⅞ x 84 ⅜ x 121 ⅞	2455	25.0	30	BAYCURB027B
15	WS*180EWR0B0000	575/3/60	12.0	177,000	56 ⅞ x 84 ⅜ x 121 ⅞	2459	29.0	35	BAYCURB027B
20	WS*240EWR0B0000	575/3/60	11.5	240,000	66 ¼ x 84 ⅜ x 121 ⅞	2641	45.0	50	BAYCURB027B
Tons	Supply Downflow W x L ^{①②}	Return Downflow W x L ^{①②}	Supply Horizontal H x W ^{①②}	Return Horizontal H x W ^{①②}	Curb Size H x W x L ^{②③}	Roof Opening W x L ^{①②}			
20	28 ⅞ x 69 ½	22 ¼ x 77	46 ⅞ x 26 ½	46 ⅞ x 27 ⅞	14 ⅞ x 81 x 117 ⅞	76 ½ x 81			

① Dimensions are in inches. See Outline Dimensions.

② Interior Dimension.

③ Measurement Includes Curb Flange.

④ HACR type circuit breaker per NEC.

⑤ Information subject to change. Please confirm with current Product Data/Service Facts for current factory production.

* Digit 3 - H = Horizontal or D = Downflow.

BUILT TO A HIGHER STANDARD™

American Standard®
HEATING & AIR CONDITIONING

Packaged Heat Pump with ReliaTel™ Controls 12½-25 Tons (Model Digit Numbers)

Digit	Description	Order Number	Digit	Description	Order Number
1	Unit Type Packaged Cooling, Electric Heat.....W		19	Disconnect Switch/Circuit Breaker No Disconnect/circuit break..... 0 Unit Mounted Non-Fused Disconnect Switch..... 1 Unit Mounted Circuit Breaker..... 2	
2	Efficiency Standard Efficiency.....S		20	Convenience Outlet Option Without Convenience Outlet..... 0 Unpowered Convenience Outlet..... A Powered Convenience Outlet..... B	
3	Airflow Configuration Downflow.....D Horizontal.....H		21	Communications Options Without Communications Options..... 0 Building Automation Control Network Communications Interface..... 6	
4-6	Nominal Gross Cooling Capacity (MBh) 12½ Tons..... 150 15 Tons..... 180 17½ Tons..... 210 20 Tons..... 240		22	Refrigeration System Option Standard refrigeration system..... 0	
7	Major Design Sequence R-410A Refrigerant.....E		23	Refrigeration Controls Without Refrigeration Controls..... 0 Frostat..... 1	
8	Voltage Selection 208-230/60/3..... 3 460/60/3..... 4 575/60/3.....W		24	Smoke Detector Without Smoke Detector..... 0 Return Air Smoke Detector..... A Supply Air Smoke Detector..... B Return/Supply Air Smoke Detector..... C Plenum Smoke Detector..... D	
9	Unit Controls ReliaTel™.....R		25	System Monitoring Controls No Monitoring Controls..... 0 Clogged Filter Switch..... 1 Fan Failure Switch..... 2 Discharge Air Sensing..... 3 Clogged Filter Switch and Fan Failure..... 4 Clogged Filter Switch and Discharge Air Sensing..... 5 Fan Failure Switch and Discharge Air Sensing..... 6 Clogged Filter Switch, Fan Failure Switch and Discharge Air Sensing..... 7 Condensate Drain Pan Overflow Switch..... A Clogged Filter Switch and Condensate Drain Pan Overflow Switch..... B Fan Failure Switch and Condensate Drain Pan Overflow Switch..... C Discharge Air Sensing and Condensate Drain Pan Overflow Switch..... D Clogged Filter Switch, Fan Failure Switch and Condensate Drain Pan Overflow Switch..... E Clogged Filter Switch, Discharge Air Sensing Tube and Condensate Drain Pan Overflow Switch.... F Fan Failure Switch, Discharge Air Sensing Tube and Condensate Drain Pan Overflow Switch..... G Clogged Filter Switch, Fan Failure Switch, Discharge Air Sensing and Condensate Drain Pan Overflow Switch..... H	
10	Heating Capacity No Heat..... 0 18 kW Electric Heat.....G 36 kW Electric Heat.....N 54 kW Electric Heat.....P 72 kW Electric Heat.....R		26	System Monitoring Controls No Monitoring Controls..... 0 Demand Control Ventilation (CO ₂)①..... A Fault Detection and Diagnostics (FDD)..... B Fault Detection and Diagnostics (FDD) with Demand Control Ventilation..... C	
11	Minor Design Sequence		27	Unit Hardware Enhancements No Enhancements..... 0 Stainless Steel Drain Pan..... 1	
12-13	Service Sequence		28	Short Circuit Current Rating (SCCR) Standard SCCR..... 0 65 kA SCCR..... A	
14	Fresh Air Selection No Fresh Air..... 0 Manual Damper..... A Motorized Damper..... B Econ Dry Bulb w/Barometric Relief..... D Econ Reference Enthalpy w/Barometric Relief..... F Econ Comparative Enthalpy w/Barometric Relief..... H Low Leak Economizer, Dry Bulb with Barometric Relief..... K Low Leak Economizer, Comparative Enthalpy with Barometric Relief..... M Low Leak Economizer, Reference Enthalpy with Barometric Relief..... P		31	Advanced Unit Controls Standard Unit Controls..... 0 Human Interface..... 1	
15	Supply Fan/Drive Type/Motor Standard Motor..... 0 Oversized Motor..... 1 High Efficiency Motor..... 3 Single Zone Variable Air Volume Standard Motor..... 6 Multi-Speed Standard Motor..... 7 Single Zone Variable Air Volume Oversized Motor..... 8 Multi-Speed Oversized Motor..... 9 Single Zone Variable Air Volume Standard Motor w/Shaft Ground Ring..... A Multi-Speed Standard Motor w/Shaft Ground Ring..... B Single Zone Variable Air Volume Oversized Motor w/Shaft Ground Ring..... C Multi-Speed Oversized Motor w/Shaft Ground Ring..... D				
16	Hinged Service Access / Filters Standard Panels/Standard Filters..... 0 Hinged Access/Standard Filters..... A Standard Panels/2" MERV 8 Filters..... B Hinged Access/2" MERV 8 Filters..... C Standard Panels/MERV 13 Filters..... D Hinged Access/MERV 13 Filters..... E				
17	Condenser Coil Protection Standard Coil..... 0 Standard Coil With Hail Guard..... 1 Black Epoxy Pre-Coated Coil..... 2 Black Epoxy Pre-Coated Coil with Hail Guard..... 3				
18	Through The Base Provisions No Through The Base Provisions..... 0 Through The Base Electric..... A Through The Base Access..... D				

Note: Most Factory Installed Options available for Downflow Air Discharge units only. Please verify with ordering system for availability.

① Demand Control Ventilation Option includes wiring only. The CO₂ sensor is a field-installed only option.

Light Commercial
Packaged Heat Pumps

For complete equipment / combination selections, installation instructions and warranty information, please refer to Product Data/Ratings and/or Installers Guides and Limited Warranty Handbooks.

BUILT TO A HIGHER STANDARD

American Standard
HEATING & AIR CONDITIONING

Packaged Heat Pump with ReliaTel™ Controls 12½-20 Tons Zone Sensors

Table LPH-13-A — Zone Sensors

Model Number	Description	Used With
ASYSTAT107A	Single Setpoint Manual Changeover	WC*150-240
ASYSTAT109A	Dual Setpoint Manual or Automatic Changeover	WC*150-240
ASYSTAT111A	Remote Room Sensor	ASYSTAT777A
ASYSTAT777A	Programmable Night Setback	WC*150-240
BAYMTPL110A	Retrofit Wall Cover Plate Kit 7.25" x 6.0"	ASYSTAT777A
BAYSENS924A①	Title 24 Zone Sensor	All

① Must be used with ReliaTel™ Control and BCI Communications Interface

BUILT TO A HIGHER STANDARD™

American Standard
HEATING & AIR CONDITIONING

Packaged Heat Pump with ReliaTel™ Controls 12½-20 Tons Accessories

Table LPH-14-A — Field Installed Accessories

Model Number	Description	Used With
BAYABRD002B ^⑥	ReliaTel™ Options Module	All Voyager Heat Pumps
BAYBCIR001A	Bacnet™ Communication Interface	ReliaTel™ Controller (BCI-R)
BAYCO2K002B ^⑦	CO ₂ Sensor Wall Mounted	All Voyager Heat Pumps w/Economizers
BAYCO2K004B ^⑦	CO ₂ Sensor Duct Mounted	All Voyager Heat Pumps w/Economizers
BAYCURB027B ^{③④}	Downflow Only Roof Curb	WSD150E-240E
BAYDFPS005A ^{⑤⑥}	Clogged Filter Switch (MERV 7)	WS*150E-240E
BAYDFPS006A ^{⑤⑥}	Fan Failure Switch	WS*150E-240E
BAYDFPS013A	Clogged Filter Switch (MERV 13)	WS*150E-240E
BAYDMPR029C	0-25% Manual Outside Air Damper	All Packaged Rooftops 12½-20 Tons
BAYDMPR058A	0-50% Motorized Outside Air Damper	WS*150E-240E
BAYECON090A ^⑥	Downflow Economizer with Barometric Relief	WSD150E-240E
BAYECON092A	Horizontal Economizer	WSH150E-240E
BAYECON701A	Downflow Low Leak Economizer	WSD150F-240F
BAYENTH007A	Reference Enthalpy Kit	All BAYECON089-92A
BAYENTH008A	Comparative Enthalpy Kit	All BAYECON089-92A
BAYFRST003A	High Temperature Stat	WS*150E-240E
BAYGARD045A ^⑥	Tool-less Hail Guard	WS*150E, WS*180E
BAYGARD050A ^⑥	Tool-less Hail Guard	WS*240E
BAYHSDR005B ^①	High Static Drive	WS*150E-240E
BAYHSMT055B	5HP OVERSIZED MOTOR KIT (208-230/460)	WS*150E, WS*180E
BAYHSMT072A	5HP OVERSIZED MOTOR KIT (575)	WS*150E, WS*180E
BAYHSMT100A	7.5HP OVERSIZED MOTOR KIT (208-230)	WS*240E
BAYHSMT101A	7.5HP OVERSIZED MOTOR KIT (460)	WS*240E
BAYHSMT102A	7.5HP OVERSIZED MOTOR KIT (575)	WS*240E
BAYLOAM023A ^{⑤⑥}	Evaporator Defrost Control (Frostat)	WS*150E, WS*180E
BAYLOAM031A	Evaporator Defrost Control	WS*240E
BAYLSDR004A	Low Static Drive	WS*240E
BAYLSDR011A	Low Static Drive	WS*150E, WS*180E
BAYPWRX029A	Power Exhaust for all Voyagers 12½-20 Ton 230V units	Downflow Only
BAYPWRX030A	Power Exhaust for all Voyagers 12½-20 Ton 460V units	Downflow Only
BAYPWRX031A	Power Exhaust for all Voyagers 12½-20 Ton 575V units	Downflow Only
BAYQACB044A	Adapter Curb	BAYCURB026A/B to BAYCURB027A/B
BAYSERV001A	Selective Resistance Service Tester	All Voyagers 12½-20 Tons
BAYSTAT023	Remote Potentiometer	All BAYECON089-92A
BAYTUBE008A ^{②⑤⑥}	Discharge Air Sensing Kit	All Voyagers 12½-20 Tons Downflow
BAYTUBE009A ^{②⑤⑥}	Discharge Air Sensing Kit	All Voyagers 12½-20 Tons Horizontal
BAYVNOR002B ^⑤	Ventilation Override Kit	WS*150-240E w/ReliaTel™ Options Module

① High static drive and oversized motors are mutually exclusive, Do not Combine.

② Used for true discharge air sensing in both heating and cooling models.

③ Clarksville Manufacturing has a no-return policy for this roof curb.

④ For downflow use only. Can not be adapted for horizontal units.

⑤ BAYABRD002B is required when ordering field installed accessories BAYDFPS005A or 006A, BAYTUBE008A or 009A and BAYLOAM023A, BAYLOAM031A or BAYVNOR002B.

⑥ Field or factory installed option.

⑦ Field installed accessory. Requires an economizer.

* Information subject to change. Please confirm with current Product Data/Service Facts for current factory production.

Light Commercial Packaged Heat Pumps

For complete equipment / combination selections, installation instructions and warranty information, please refer to Product Data/Ratings and/or Installers Guides and Limited Warranty Handbooks.

Packaged Heat Pump with ReliaTel™ Controls 12½-20 Tons Heaters

Table LPH-15-A — Downflow Supplementary Heaters:

Model Number	Power Supply	kW Rating	BTUH	Nominal Stages	Used With
AYDHTRK318B	208-230/3/60	13.5/18.0	46,100/61,400	1	WSD150-180E
AYDHTRK336B	208-230/3/60	27.0/36.0	92,200/122,900	2	WSD150-180E
AYDHTRK354B	208-230/3/60	40.5/54.0	138,200/184,300	2	WSD150-180E
AYDHTRK418B	460/3/60	18.0	61,400	1	WSD150-180E
AYDHTRK436B	460/3/60	36.0	122,900	2	WSD150-180E
AYDHTRK454B	460/3/60	54.0	184,300	2	WSD150-180E
AYDHTRL336B	208-230/3/60	27.0/36.0	92,200/122,900	2	WSD240E
AYDHTRL354B	208-230/3/60	40.5/54.0	138,200/184,300	2	WSD240E
AYDHTRK372B	208-230/3/60	54.0/72.0	184,300/245,700	2	WSD240E
AYDHTRL436B	460/3/60	36.0	122,900	2	WSD240E
AYDHTRL454B	460/3/60	54.0	184,300	2	WSD240E
AYDHTRK472B	460/3/60	72.0	245,700	2	WSD240E
AYDHTRKW18B	575/3/60	18.0	61,400	1	WSD150-180E
AYDHTRKW36B	575/3/60	36.0	122,900	2	WSD150-180E
AYDHTRKW54B	575/3/60	54.0	184,300	2	WSD150-180E
AYDHTRLW36B	575/3/60	36.0	122,900	2	WSD240E
AYDHTRLW54B	575/3/60	54.0	184,300	2	WSD240E
AYDHTRKW72B	575/3/60	72.0	245,700	2	WSD240E

Table LPH-15-B — Horizontal Supplementary Heaters:

AYHHTRM318B	208-230/3/60	13.5/18.0	46,100/61,400	1	WSH150-180E
AYHHTRM336B	208-230/3/60	27.0/36.0	92,200/122,900	2	WSH150-180E
AYHHTRM354B	208-230/3/60	40.5/54.0	138,200/184,300	2	WSH150-180E
AYHHTRM418B	460/3/60	18.0	61,400	1	WSH150-180E
AYHHTRP436B	460/3/60	36.0	122,900	2	WSH150-180E
AYHHTRM454B	460/3/60	54.0	184,300	2	WSH150-180E
AYHHTRN336B	208-230/3/60	27.0/36.0	92,200/122,900	2	WSH240E
AYHHTRN354B	208-230/3/60	40.5/54.0	138,200/184,300	2	WSH240E
AYHHTRN372B	208-230/3/60	54.0/72.0	184,300/245,700	2	WSH240E
AYHHTRN436B	460/3/60	36.0	122,900	2	WSH240E
AYHHTRN454B	460/3/60	54.0	184,300	2	WSH240E
AYHHTRN472B	460/3/60	72.0	245,700	2	WSH240E
AYHHTRMW18B	575/3/60	18.0	61,400	1	WSH150-180E
AYHHTRMW36B	575/3/60	36.0	122,900	2	WSH150-180E
AYHHTRMW54B	575/3/60	54.0	184,300	2	WSH150-180E
AYHHTRNW36B	575/3/60	36.0	122,900	2	WSH240E
AYHHTRNW54B	575/3/60	54.0	184,300	2	WSH240E
AYHHTRNW72B	575/3/60	72.0	245,700	2	WSH240E

Note: Unit with heater is single circuit/single point.

See ReliaTel™ and Micro Control features on LPC-12 and LPC-13.

For complete equipment / combination selections, installation instructions and warranty information, please refer to Product Data/Ratings and/or Installers Guides and Limited Warranty Handbooks.



Beveled Top
Smoother Design
Small compact cabinet
Recessed access handles

Packaged Gas/Electric Convertible 3-10 Tons

Standard Features:

- American Standard Heating & Air Conditioning scroll compressors on all 3-10 ton units
- Colored and numbered wiring
- Phase Monitor, R-410A, 3 Phase Units
- Provisions for through the Base Gas and Condensate Drain Connections
- Crankcase Heaters
- 2" throwaway filters provided on all units
- Liquid Line Refrigerant Drier
- Operating Charge of R-410A
- IAQ Sloped Drain Pans
- Low Ambient to 40°F on Electromechanical models
- Low Ambient to 0°F on ReliaTel™ models
- 5 - year Limited Compressor Warranty
- 5 - year Limited Heat Exchanger Warranty
- 1 - year Limited Parts Warranty

Added Flexibility

- Electromechanical or ReliaTel™ controls (**See page LPC-12 for ReliaTel™ Control Information**)
- Standard or high efficiency cooling models available. 17+ available in 3-5T. For reference to 17+ please refer to publications RT-PRC048-EN and RT-SLB020-EN.
- Low, medium or high heat, single or two stage
- Convertible airflow
- Fork lift openings on three sides of unit
- Direct or belt drive - standard or oversized motors
- We don't prepackage options
- Choose options tailored to suit each job —pay only for what is needed
- Units ship with options installed —and within our standard ship cycle time

Factory Installed Options

- Through-the-Base — Electrical
- Convenience Outlet — Powered or unpowered
- Unit Disconnect Switch
- Circuit Breaker
- Smoke Detectors — Supply, return, or both
- Condenser Coil Coating
- Hinged Access Service Panels
- Discharge Air Sensor
- Fan Fail and Clogged Filter Switches
- Condenser Coil Guard — Hail Protection Quality
- Hot Gas Reheat Coil - Dehumidification (High Efficiency Units Only)
- Expansion valve and split face evaporator coil
- Comm 3/4 Communications Interface
- BACnet™ Communications Interface
- 2" Pleated Media filters (MERV 8 & 13)
- Froststat
- Multi-Speed & Single Zone VAV ID Airflow
- Demand Control Ventilation
- Stainless Steel Drainpan
- Condensate Drainpan Overflow Switch

The same American Standard Heating & Air Conditioning Quality and Reliability ... with added Flexibility!

BUILT TO A HIGHER STANDARD[®]

American Standard[®]
HEATING & AIR CONDITIONING

Packaged Gas/Electric Convertible 3-5 Tons, 17 SEER, R-410A

Table LPG-2-A — Precedent™ 17 Plus - R-410A - ReliaTel™ Controls Only

Tons	Unit Ordering No.	Performance SEER	Cooling Capacity (Btuh)	Heating Output ^① Capacity (Btuh)	S.S. Furnace Eff%	Cabinet Dimensions (in.) H x W x L	Downflow Supply	Downflow Return	Shipping Weight (lbs.)	MCA**	Max. Fuse**
YHC - 208-230/3/60 - Three Phase - Low Heat											
3	YHC037E3RLA0000	17.5	36,500	48,000	78	36 x 44 x 69	18 x 15.5	24 x 14	676	24	30
4	YHC047E3RLA0000	17.5	50,500	49,000	80	41 x 53 x 88	33 x 17.5	32 x 17.5	858	30	40
5	YHC067E3RLA0000	17.2	60,000	49,000	80	41 x 53 x 88	33 x 17.5	32 x 17.5	917	33	45
YHC - 460/3/60 - Three Phase - Low Heat											
3	YHC037E4RLA0000	17.5	36,500	48,000	78	36 x 44 x 69	18 x 15.5	24 x 14	676	12	15
4	YHC047E4RLA0000	17.5	50,500	49,000	80	41 x 53 x 88	33 x 17.5	32 x 17.5	858	14	20
5	YHC067E4RLA0000	17.2	60,000	49,000	80	41 x 53 x 88	33 x 17.5	32 x 17.5	917	16	20
YHC - 575/3/60 - Three Phase - Low Heat											
3	YHC037EWRLA0000	17.5	36,500	48,000	78	36 x 44 x 69	18 x 15.5	24 x 14	676	9	15
4	YHC047EWRLA0000	17.5	50,500	49,000	80	41 x 53 x 88	33 x 17.5	32 x 17.5	858	11	15
5	YHC067EWRLA0000	17.2	60,000	49,000	80	41 x 53 x 88	33 x 17.5	32 x 17.5	917	12	15
YHC - 208-230/3/60 - Three Phase - Medium Heat											
3	YHC037E3RMA0000	17.5	36,500	64,000	78	36 x 44 x 69	18 x 15.5	24 x 14	676	24	30
4	YHC047E3RMA0000	17.5	50,500	64,000	80	41 x 53 x 88	33 x 17.5	32 x 17.5	858	30	40
5	YHC067E3RMA0000	17.2	60,000	64,000	80	41 x 53 x 88	33 x 17.5	32 x 17.5	917	33	45
YHC - 460/3/60 - Three Phase - Medium Heat											
3	YHC037E4RMA0000	17.5	36,500	64,000	78	36 x 44 x 69	18 x 15.5	24 x 14	676	12	15
4	YHC047E4RMA0000	17.5	50,500	64,000	80	41 x 53 x 88	33 x 17.5	32 x 17.5	858	14	20
5	YHC067E4RMA0000	17.2	60,000	64,000	80	41 x 53 x 88	33 x 17.5	32 x 17.5	917	16	20
YHC - 575/3/60 - Three Phase - Medium Heat											
3	YHC037EWRMA0000	17.5	36,500	64,000	78	36 x 44 x 69	18 x 15.5	24 x 14	676	9	15
4	YHC047EWRMA0000	17.5	50,500	64,000	80	41 x 53 x 88	33 x 17.5	32 x 17.5	858	11	15
5	YHC067EWRMA0000	17.2	60,000	64,000	80	41 x 53 x 88	33 x 17.5	32 x 17.5	917	12	15
YHC - 208-230/3/60 - Three Phase - High Heat											
3	YHC037E3RMA0000	17.5	36,500	80,000	78	36 x 44 x 69	18 x 15.5	24 x 14	676	24	30
4	YHC047E3RMA0000	17.5	50,500	96,000	80	41 x 53 x 88	33 x 17.5	32 x 17.5	858	30	40
5	YHC067E3RMA0000	17.2	60,000	104,000	80	41 x 53 x 88	33 x 17.5	32 x 17.5	917	33	45
YHC - 460/3/60 - Three Phase - High Heat											
3	YHC037E4RMA0000	17.5	36,500	80,000	78	36 x 44 x 69	18 x 15.5	24 x 14	676	12	15
4	YHC047E4RMA0000	17.5	50,500	96,000	80	41 x 53 x 88	33 x 17.5	32 x 17.5	858	14	20
5	YHC067E4RMA0000	17.2	60,000	104,000	80	41 x 53 x 88	33 x 17.5	32 x 17.5	917	16	20
YHC - 575/3/60 - Three Phase - High Heat											
3	YHC037EWRMA0000	17.5	36,500	80,000	78	36 x 44 x 69	18 x 15.5	24 x 14	676	9	15
4	YHC047EWRMA0000	17.5	50,500	96,000	80	41 x 53 x 88	33 x 17.5	32 x 17.5	858	11	15
5	YHC067EWRMA0000	17.2	60,000	104,000	80	41 x 53 x 88	33 x 17.5	32 x 17.5	917	12	15

① Downflow Airflow/Horizontal Airflow

** Information subject to change. Please confirm with current Product Data/Service Facts for current factory production.

Packaged Gas/Electric Convertible 3-5 Tons, 15 SEER, R-410A

Table LPG-3-A - Base Unit - 15 SEER High Efficiency - Electromechanical or ReliaTel™

Tons	Unit Ordering No.	Performance SEER	Cooling Capacity (Btuh)	Heating Output ^① Capacity (Btuh)	AFUE/S.S. Furnace Eff%	Cabinet Dimensions (in.) H x W x L	Downflow Supply	Downflow Return	Shipping Weight (lbs.)	MCA**	Max. Fuse**
YHC - 208-230/1/60 - Single Phase - Low Heat											
3	YHC036E1*LB0000	15.2	38,490	49,200	81	36 x 44 x 69	18 x 15.5	24 x 14	555	28	45
4	YHC048F1*LB0000	15.0	48,930	49,200	81	41 x 53 x 88	33 x 17.5	32 x 17.5	798	37	50
5	YHC060F1*LB0000	15.0	61,000	49,800	81	41 x 53 x 88	33 x 17.5	32 x 17.5	823	41	60
YHC - 208-230/3/60 - Three Phase - Low Heat											
3	YHC036E3*LA0000	15.0	37,600	48,000	78	36 x 44 x 69	18 x 15.5	24 x 14	637	21	30
4	YHC048F3*LA0000	15.0	49,930	49,000	80	41 x 53 x 88	33 x 17.5	32 x 17.5	869	26	35
5	YHC060F3*LA0000	15.0	61,000	49,000	80	41 x 53 x 88	33 x 17.5	32 x 17.5	894	30	45
YHC - 460/3/60 - Three Phase - Low Heat											
3	YHC036E4*LA0000	15.0	37,600	48,000	78	36 x 44 x 69	18 x 15.5	24 x 14	637	12	15
4	YHC048F4*LA0000	15.0	49,930	49,000	80	41 x 53 x 88	33 x 17.5	32 x 17.5	869	13	15
5	YHC060F4*LA0000	15.0	61,000	49,000	80	41 x 53 x 88	33 x 17.5	32 x 17.5	894	14	20
YHC - 575/3/60 - Three Phase - Low Heat											
3	YHC036EW*LA0000	14.4	37,600	48,000	78	36 x 44 x 69	18 x 15.5	24 x 14	637	10	15
4	YHC048FW*LA0000	15.0	49,930	49,000	80	41 x 53 x 88	33 x 17.5	32 x 17.5	869	11	15
5	YHC060FW*LA0000	15.0	61,000	49,000	80	41 x 53 x 88	33 x 17.5	32 x 17.5	894	11	15
YHC - 208-230/1/60 - Single Phase - Medium Heat											
3	YHC036E1*MB0000	15.2	38,490	65,600	81	36 x 44 x 69	18 x 15.5	24 x 14	555	28	45
4	YHC048F1*MB0000	15.0	48,930	66,400	81	41 x 53 x 88	33 x 17.5	32 x 17.5	798	37	50
5	YHC060F1*MB0000	15.0	61,000	65,600	81	41 x 53 x 88	33 x 17.5	32 x 17.5	823	41	60
YHC - 208-230/3/60 - Three Phase - Medium Heat											
3	YHC036E3*MA0000	15.0	37,600	64,000	78	36 x 44 x 69	18 x 15.5	24 x 14	676	21	30
4	YHC048F3*MA0000	15.0	49,930	64,000	79	41 x 53 x 88	33 x 17.5	32 x 17.5	858	26	35
5	YHC060F3*MA0000	15.0	61,000	64,000	79	41 x 53 x 88	33 x 17.5	32 x 17.5	917	30	45
YHC - 460/3/60 - Three Phase - Medium Heat											
3	YHC036E4*MA0000	15.0	37,600	64,000	78	36 x 44 x 69	18 x 15.5	24 x 14	676	12	15
4	YHC048F4*MA0000	15.0	49,930	64,000	79	41 x 53 x 88	33 x 17.5	32 x 17.5	858	13	15
5	YHC060F4*MA0000	15.0	61,000	64,000	79	41 x 53 x 88	33 x 17.5	32 x 17.5	917	14	20
YHC - 575/3/60 - Three Phase - Medium Heat											
3	YHC036EW*MA0000	14.4	37,600	64,000	78	36 x 44 x 69	18 x 15.5	24 x 14	676	10	15
4	YHC048FW*MA0000	15.0	49,930	64,000	79	41 x 53 x 88	33 x 17.5	32 x 17.5	858	11	15
5	YHC060FW*MA0000	15.0	61,000	64,000	79	41 x 53 x 88	33 x 17.5	32 x 17.5	917	11	15
YHC - 208-230/1/60 - Single Phase - High Heat											
3	YHC036E1*HB0000	15.2	38,490	82,000	81	36 x 44 x 69	18 x 15.5	24 x 14	555	28	45
4	YHC048F1*HB0000	15.0	48,930	98,400	81	41 x 53 x 88	33 x 17.5	32 x 17.5	798	37	50
5	YHC060F1*HB0000	15.0	61,000	106,600	81	41 x 53 x 88	33 x 17.5	32 x 17.5	823	41	60
YHC - 208-230/3/60 - Three Phase - High Heat											
3	YHC036E3*HA0000	15.0	37,600	96,000	78	36 x 44 x 69	18 x 15.5	24 x 14	676	21	30
4	YHC048F3*HA0000	15.0	49,930	96,000	79	41 x 53 x 88	33 x 17.5	32 x 17.5	858	26	35
5	YHC060F3*HA0000	15.0	61,000	104,000	80	41 x 53 x 88	33 x 17.5	32 x 17.5	917	30	45
YHC - 460/3/60 - Three Phase - High Heat											
3	YHC036E4*HA0000	15.0	37,600	96,000	78	36 x 44 x 69	18 x 15.5	24 x 14	676	12	15
4	YHC048F4*HA0000	15.0	49,930	96,000	79	41 x 53 x 88	33 x 17.5	32 x 17.5	858	13	15
5	YHC060F4*HA0000	15.0	61,000	104,000	80	41 x 53 x 88	33 x 17.5	32 x 17.5	917	14	20
YHC - 575/3/60 - Three Phase - High Heat											
3	YHC036EW*HA0000	14.4	37,600	96,000	78	36 x 44 x 69	18 x 15.5	24 x 14	676	10	15
4	YHC048FW*HA0000	15.0	49,930	96,000	79	41 x 53 x 88	33 x 17.5	32 x 17.5	858	11	15
5	YHC060FW*HA0000	15.0	61,000	104,000	80	41 x 53 x 88	33 x 17.5	32 x 17.5	917	11	15

① Downflow Airflow/Horizontal Airflow

* Digit 9-E=Electromechanical or R=ReliaTel™.

** Information subject to change. Please confirm with current Product Data/Service Facts for current factory production.

BUILT TO A HIGHER STANDARD[®]

American Standard[®]
HEATING & AIR CONDITIONING

Packaged Gas/Electric Convertible 3-5 Tons, 14 SEER, R-410A

Table LPG-4-A - Base Unit - 14 SEER - Electromechanical or ReliaTel™

Tons	Unit Ordering No.	Performance SEER	Cooling Capacity (Btuh)	Heating Output ^① Capacity Lo/Hi (Btuh)	AFUE%	Cabinet Dimensions (in.) H x W x L	Downflow Supply	Downflow Return	Shipping Weight (lbs.)	MCA**	Max. Fuse**
YSC - 208/230/3/60 - Three Phase - Low Heat											
3	YSC036G3*LB0000	14.0	37,000	44,800/64,000	82	41 x 44 x 69	18 x 15.5	24 x 14	577	20	30
4	YSC048G3*LB0000	14.0	49,000	44,800/64,000	82	41 x 44 x 69	18 x 15.5	24 x 14	598	26	35
5	YSC060G3*LB0000	14.0	60,000	44,800/64,000	82	41 x 44 x 69	18 x 15.5	24 x 14	627	29	40
YSC - 460/3/60 - Three Phase - Low Heat											
3	YSC036G4*LB0000	14.0	37,000	44,800/64,000	82	41 x 44 x 69	18 x 15.5	24 x 14	577	10	15
4	YSC048G4*LB0000	14.0	49,000	44,800/64,000	82	41 x 44 x 69	18 x 15.5	24 x 14	598	11	15
5	YSC060G4*LB0000	14.0	60,000	44,800/64,000	82	41 x 44 x 69	18 x 15.5	24 x 14	627	13	15
YSC - 575/3/60 - Three Phase - Low Heat											
3	YSC036GW*LB0000	14.0	37,000	44,800/64,000	82	41 x 44 x 69	18 x 15.5	24 x 14	577	8	15
4	YSC048GW*LB0000	14.0	49,000	44,800/64,000	82	41 x 44 x 69	18 x 15.5	24 x 14	598	10	15
5	YSC060GW*LB0000	14.0	60,000	44,800/64,000	82	41 x 44 x 69	18 x 15.5	24 x 14	627	10	15
YSC - 208/230/3/60 - Three Phase - Medium Heat											
3	YSC036G3*MB0000	14.0	37,000	56,000/80,000	82	41 x 44 x 69	18 x 15.5	24 x 14	577	20	30
4	YSC048G3*MB0000	14.0	49,000	56,000/80,000	82	41 x 44 x 69	18 x 15.5	24 x 14	598	26	35
5	YSC060G3*MB0000	14.0	60,000	56,000/80,000	82	41 x 44 x 69	18 x 15.5	24 x 14	627	29	40
YSC - 460/3/60 - Three Phase - Medium Heat											
3	YSC036G4*MB0000	14.0	37,000	56,000/80,000	82	41 x 44 x 69	18 x 15.5	24 x 14	577	10	15
4	YSC048G4*MB0000	14.0	49,000	56,000/80,000	82	41 x 44 x 69	18 x 15.5	24 x 14	598	11	15
5	YSC060G4*MB0000	14.0	60,000	56,000/80,000	82	41 x 44 x 69	18 x 15.5	24 x 14	627	13	15
YSC - 575/3/60 - Three Phase - Medium Heat											
3	YSC036GW*MB0000	14.0	37,000	56,000/80,000	82	41 x 44 x 69	18 x 15.5	24 x 14	577	8	15
4	YSC048GW*MB0000	14.0	49,000	56,000/80,000	82	41 x 44 x 69	18 x 15.5	24 x 14	598	10	15
5	YSC060GW*MB0000	14.0	60,000	56,000/80,000	82	41 x 44 x 69	18 x 15.5	24 x 14	627	10	15
YSC - 208/230/3/60 - Three Phase - High Heat											
3	YSC036G3*HB0000	14.0	37,000	67,200/96,000	82	41 x 44 x 69	18 x 15.5	24 x 14	577	20	30
4	YSC048G3*HB0000	14.0	49,000	72,800/104,000	82	41 x 44 x 69	18 x 15.5	24 x 14	598	26	35
5	YSC060G3*HB0000	14.0	60,000	84,000/120,000	82	41 x 44 x 69	18 x 15.5	24 x 14	627	29	40
YSC - 460/3/60 - Three Phase - High Heat											
3	YSC036G4*HB0000	14.0	37,000	67,200/96,000	82	41 x 44 x 69	18 x 15.5	24 x 14	577	10	15
4	YSC048G4*HB0000	14.0	49,000	72,800/104,000	82	41 x 44 x 69	18 x 15.5	24 x 14	598	11	15
5	YSC060G4*HB0000	14.0	60,000	84,000/120,000	82	41 x 44 x 69	18 x 15.5	24 x 14	627	13	15
YSC - 575/3/60 - Three Phase - High Heat											
3	YSC036GW*HB0000	14.0	37,000	67,200/96,000	82	41 x 44 x 69	18 x 15.5	24 x 14	577	8	15
4	YSC048GW*HB0000	14.0	49,000	72,800/104,000	82	41 x 44 x 69	18 x 15.5	24 x 14	598	10	15
5	YSC060GW*HB0000	14.0	60,000	84,000/120,000	82	41 x 44 x 69	18 x 15.5	24 x 14	627	10	15

① Downflow Airflow/Horizontal Airflow

* Digit 9-E=Electromechanical or R=ReliaTel™.

** Information subject to change. Please confirm with current Product Data/Service Facts for current factory production.

Packaged Gas/Electric Convertible 6-10 Tons, High Efficiency, R-410A

Table LPG-5-A — Base Unit — High Efficiency — Electromechanical or ReliaTel™

Tons	Unit Ordering No.	Performance IEER	Cooling Capacity (Btuh)	Heating Output ^① Capacity (Btuh)	AFUE%	Cabinet Dimensions (in.) H x W x L	Downflow Supply	Downflow Return	Shipping Weight (lbs.)	MCA**	Max. Fuse**
YHC - 208/230/3/60 - Three Phase - Low Heat											
6	YHC072F3*LA0000	14.5	72,000	64,000	80	47 x 53 x 88	33 x 17.5	32 x 17.5	997	31	45
6	YHC074F3*LA0000	15.5	73,000	64,800	81	47 x 53 x 88	33 x 17.5	32 x 17.5	1114	37	50
7 ½	YHC092F3*LA0000	14.5	92,000	96,000	80	47 x 53 x 88	33 x 17.5	32 x 17.5	1124	42	50
8 ½	YHC102F3*LA0000	14.7	104,000	96,000	80	47 x 53 x 88	33 x 17.5	32 x 17.5	1124	41	50
10	YHC120F3*LA0000	14.7	116,000	84,000/120,000	80	51 x 63 x 100	33 x 17.5	32 x 17.5	1563	48	60
YHC - 460/3/60 - Three Phase - Low Heat											
6	YHC072F4*LA0000	14.5	72,000	64,000	80	47 x 53 x 88	33 x 17.5	32 x 17.5	997	15	20
6	YHC074F4*LA0000	15.5	73,000	64,800	81	47 x 53 x 88	33 x 17.5	32 x 17.5	1114	18	20
7 ½	YHC092F4*LA0000	14.5	92,000	96,000	80	47 x 53 x 88	33 x 17.5	32 x 17.5	1124	20	25
8 ½	YHC102F4*LA0000	14.7	104,000	96,000	80	47 x 53 x 88	33 x 17.5	32 x 17.5	1124	21	25
10	YHC120F4*LA0000	14.7	116,000	84,000/120,000	80	51 x 63 x 100	33 x 17.5	32 x 17.5	1563	22	25
YHC - 575/3/60 - Three Phase - Low Heat											
6	YHC072FW*LA0000	14.5	72,000	64,000	80	47 x 53 x 88	33 x 17.5	32 x 17.5	997	13	15
7 ½	YHC092FW*LA0000	14.5	92,000	96,000	80	47 x 53 x 88	33 x 17.5	32 x 17.5	1124	21	25
8 ½	YHC102FW*LA0000	14.5	104,000	96,000	80	47 x 53 x 88	33 x 17.5	32 x 17.5	1124	22	25
10	YHC120FW*LA0000	14.7	116,000	84,000/120,000	80	51 x 63 x 100	33 x 17.5	32 x 17.5	1563	22	25
YHC - 208/230/3/60 - Three Phase - Medium Heat											
6	YHC072F3*MA0000	14.5	72,000	96,000	80	47 x 53 x 88	33 x 17.5	32 x 17.5	997	31	45
6	YHC074F3*MA0000	15.5	73,000	97,200	81	47 x 53 x 88	33 x 17.5	32 x 17.5	1114	37	50
7 ½	YHC092F3*MA0000	14.5	92,000	84,000/120,000	80	47 x 53 x 88	33 x 17.5	32 x 17.5	1124	42	50
8 ½	YHC102F3*MA0000	14.7	104,000	84,000/120,000	80	47 x 53 x 88	33 x 17.5	32 x 17.5	1124	41	50
10	YHC120F3*MA0000	14.7	116,000	112,000/160,000	80	51 x 63 x 100	33 x 17.5	32 x 17.5	1563	48	60
YHC - 460/3/60 - Three Phase - Medium Heat											
6	YHC072F4*MA0000	14.5	72,000	96,000	80	47 x 53 x 88	33 x 17.5	32 x 17.5	997	15	20
6	YHC074F4*MA0000	15.5	73,000	97,200	81	47 x 53 x 88	33 x 17.5	32 x 17.5	1114	18	20
7 ½	YHC092F4*MA0000	14.5	92,000	84,000/120,000	80	47 x 53 x 88	33 x 17.5	32 x 17.5	1124	20	25
8 ½	YHC102F4*MA0000	14.7	104,000	84,000/120,000	80	47 x 53 x 88	33 x 17.5	32 x 17.5	1124	21	25
10	YHC120F4*MA0000	14.7	116,000	112,000/160,000	80	51 x 63 x 100	33 x 17.5	32 x 17.5	1563	22	25
YHC - 575/3/60 - Three Phase - Medium Heat											
6	YHC072FW*MA0000	14.5	72,000	96,000	80	47 x 53 x 88	33 x 17.5	32 x 17.5	997	13	15
7 ½	YHC092FW*MA0000	14.5	92,000	84,000/120,000	80	47 x 53 x 88	33 x 17.5	32 x 17.5	1124	21	25
8 ½	YHC102FW*MA0000	14.5	104,000	84,000/120,000	80	47 x 53 x 88	33 x 17.5	32 x 17.5	1124	22	25
10	YHC120FW*MA0000	14.7	116,000	112,000/160,000	80	51 x 63 x 100	33 x 17.5	32 x 17.5	1563	22	25
YHC - 208/230/1/60 - Three Phase - High Heat											
6	YHC072F3*HA0000	14.5	72,000	84,000/120,000	80	47 x 53 x 88	33 x 17.5	32 x 17.5	997	31	45
6	YHC074F3*HA0000	15.5	73,000	85,050/121,050	81	47 x 53 x 88	33 x 17.5	32 x 17.5	1114	37	50
7 ½	YHC092F3*HA0000	14.5	92,000	112,000/160,000	80	47 x 53 x 88	33 x 17.5	32 x 17.5	1124	42	50
8 ½	YHC102F3*HA0000	14.7	104,000	112,000/160,000	80	47 x 53 x 88	33 x 17.5	32 x 17.5	1124	41	50
10	YHC120F3*HA0000	14.7	116,000	140,000/200,000	80	51 x 63 x 100	33 x 17.5	32 x 17.5	1563	48	60
YHC - 208/230/3/60 - Three Phase - High Heat											
6	YHC072F4*HA0000	14.5	72,000	84,000/120,000	80	47 x 53 x 88	33 x 17.5	32 x 17.5	997	15	20
6	YHC074F4*HA0000	15.5	73,000	85,050/121,050	81	47 x 53 x 88	33 x 17.5	32 x 17.5	1114	18	20
7 ½	YHC092F4*HA0000	14.5	92,000	112,000/160,000	80	47 x 53 x 88	33 x 17.5	32 x 17.5	1124	20	25
8 ½	YHC102F4*HA0000	14.7	104,000	112,000/160,000	80	47 x 53 x 88	33 x 17.5	32 x 17.5	1124	21	25
10	YHC120F4*HA0000	14.7	116,000	140,000/200,000	80	51 x 63 x 100	33 x 17.5	32 x 17.5	1563	22	25
YHC - 575/3/60 - Three Phase - High Heat											
6	YHC072FW*HA0000	14.5	72,000	84,000/120,000	80	47 x 53 x 88	33 x 17.5	32 x 17.5	997	13	15
7 ½	YHC092FW*HA0000	14.5	92,000	112,000/160,000	80	47 x 53 x 88	33 x 17.5	32 x 17.5	1124	21	25
8 ½	YHC102FW*HA0000	14.5	104,000	112,000/160,000	80	47 x 53 x 88	33 x 17.5	32 x 17.5	1124	22	25
10	YHC120FW*HA0000	14.7	116,000	140,000/200,000	80	51 x 63 x 100	33 x 17.5	32 x 17.5	1563	22	25

① Downflow Airflow/Horizontal Airflow

* Digit 9-E=Electromechanical or R=ReliaTel™.

** Information subject to change. Please confirm with current Product Data/Service Facts for current factory production.

BUILT TO A HIGHER STANDARD[®]

American Standard[®]
HEATING & AIR CONDITIONING

Packaged Gas/Electric Convertible 6-10 Tons, R-410A

Table LPG-6-A — Base Unit — Standard Efficiency — Electromechanical or ReliaTel™

Tons	Unit Ordering No.	Performance IEEER	Cooling Capacity (Btuh)	Heating Output ^① Capacity (Btuh)	AFUE%	Cabinet Dimensions (in.) H x W x L	Downflow Supply	Downflow Return	Shipping Weight (lbs.)	MCA**	Max. Fuse**
YSC –208-230/3/60 – Three Phase – Low Heat											
6	YSC072H3*LA0000	12.7	75,000	64,000	80	41 x 53 x 89	33 x 17.5	32 x 17.5	936	35	50
7½	YSC090H3*LA0000	12.7	92,500	96,000	80	41 x 53 x 89	33 x 17.5	32 x 17.5	916	38	60
7½	YSC092H3*LA0000	12.7	94,800	96,000	80	47 x 53 x 89	33 x 17.5	32 x 17.5	1059	39	50
8½	YSC102H3*LA0000	12.7	107,200	96,000	80	47 x 53 x 89	33 x 17.5	32 x 17.5	1096	44	50
10	YSC120H3*LA0000	12.7	116,000	84,000/120,000	80	47 x 53 x 89	33 x 17.5	32 x 17.5	1156	49	60
YSC –460/3/60 – Three Phase – Low Heat											
6	YSC072H4*LA0000	12.7	75,000	64,000	80	41 x 53 x 89	33 x 17.5	32 x 17.5	936	17	25
7½	YSC090H4*LA0000	12.7	92,500	96,000	80	41 x 53 x 89	33 x 17.5	32 x 17.5	916	19	30
7½	YSC092H4*LA0000	12.7	94,800	96,000	80	47 x 53 x 89	33 x 17.5	32 x 17.5	1059	18	20
8½	YSC102H4*LA0000	12.7	107,200	96,000	80	47 x 53 x 89	33 x 17.5	32 x 17.5	1096	21	25
10	YSC120H4*LA0000	12.7	116,000	84,000/120,000	80	47 x 53 x 89	33 x 17.5	32 x 17.5	1156	22	25
YSC –575/3/60 – Three Phase – Low Heat											
6	YSC072HW*LA0000	12.7	75,000	64,000	80	41 x 53 x 89	33 x 17.5	32 x 17.5	936	13	20
7½	YSC090HW*LA0000	12.7	92,500	96,000	80	41 x 53 x 89	33 x 17.5	32 x 17.5	916	15	20
7½	YSC092HW*LA0000	12.7	94,800	96,000	80	47 x 53 x 89	33 x 17.5	32 x 17.5	1059	15	20
8½	YSC102HW*LA0000	12.7	107,200	96,000	80	47 x 53 x 89	33 x 17.5	32 x 17.5	1096	16	20
10	YSC120HW*LA0000	12.7	116,000	84,000/120,000	80	47 x 53 x 89	33 x 17.5	32 x 17.5	1156	22	25
YSC –208-230/3/60 – Three Phase – Medium Heat											
6	YSC072H3*MA0000	12.7	75,000	96,000	80	41 x 53 x 89	33 x 17.5	32 x 17.5	936	35	50
7½	YSC090H3*MA0000	12.7	92,500	84,000/120,000	80	41 x 53 x 89	33 x 17.5	32 x 17.5	916	38	60
7½	YSC092H3*MA0000	12.7	94,800	84,000/120,000	80	47 x 53 x 89	33 x 17.5	32 x 17.5	1059	39	50
8½	YSC102H3*MA0000	12.7	107,200	84,000/120,000	80	47 x 53 x 89	33 x 17.5	32 x 17.5	1096	44	50
10	YSC120H3*MA0000	12.7	116,000	112,000/160,000	80	47 x 53 x 89	33 x 17.5	32 x 17.5	1156	49	60
YSC –460/3/60 – Three Phase – Medium Heat											
6	YSC072H4*MA0000	12.7	75,000	96,000	80	41 x 53 x 89	33 x 17.5	32 x 17.5	936	17	25
7½	YSC090H4*MA0000	12.7	92,500	84,000/120,000	80	41 x 53 x 89	33 x 17.5	32 x 17.5	916	19	30
7½	YSC092H4*MA0000	12.7	94,800	84,000/120,000	80	47 x 53 x 89	33 x 17.5	32 x 17.5	1059	18	20
8½	YSC102H4*MA0000	12.7	107,200	84,000/120,000	80	47 x 53 x 89	33 x 17.5	32 x 17.5	1096	21	25
10	YSC120H4*Ma0000	12.7	116,000	112,000/160,000	80	47 x 53 x 89	33 x 17.5	32 x 17.5	1156	22	25
YSC –575/3/60 – Three Phase – Medium Heat											
6	YSC072HW*MA0000	12.7	75,000	96,000	80	41 x 53 x 89	33 x 17.5	32 x 17.5	936	13	20
7½	YSC090HW*MA0000	12.7	92,500	84,000/120,000	80	41 x 53 x 89	33 x 17.5	32 x 17.5	916	15	20
7½	YSC092HW*MA0000	12.7	94,800	84,000/120,000	80	47 x 53 x 89	33 x 17.5	32 x 17.5	1059	15	20
8½	YSC102HW*MA0000	12.7	107,200	84,000/120,000	80	47 x 53 x 89	33 x 17.5	32 x 17.5	1096	16	20
10	YSC120HW*MA0000	12.7	116,000	112,000/160,000	80	47 x 53 x 89	33 x 17.5	32 x 17.5	1156	22	25
YSC –208-230/3/60 – Three Phase – High Heat											
6	YSC072H3*HA0000	12.7	75,000	84,000/120,000	80	41 x 53 x 89	33 x 17.5	32 x 17.5	936	35	50
7½	YSC090H3*HA0000	12.7	92,500	112,000/160,000	80	41 x 53 x 89	33 x 17.5	32 x 17.5	916	38	60
7½	YSC092H3*HA0000	12.7	94,800	112,000/160,000	80	47 x 53 x 89	33 x 17.5	32 x 17.5	1059	39	50
8½	YSC102H3*HA0000	12.7	107,200	112,000/160,000	80	47 x 53 x 89	33 x 17.5	32 x 17.5	1096	44	50
10	YSC120H3*HA0000	12.7	116,000	140,000/200,000	80	47 x 53 x 89	33 x 17.5	32 x 17.5	1156	49	60
YSC –460/3/60 – Three Phase – High Heat											
6	YSC072H4*HA0000	12.7	75,000	84,000/120,000	80	41 x 53 x 89	33 x 17.5	32 x 17.5	936	17	25
7½	YSC090H4*HA0000	12.7	92,500	112,000/160,000	80	41 x 53 x 89	33 x 17.5	32 x 17.5	916	19	30
7½	YSC092H4*HA0000	12.7	94,800	112,000/160,000	80	47 x 53 x 89	33 x 17.5	32 x 17.5	1059	18	20
8½	YSC102H4*HA0000	12.7	107,200	112,000/160,000	80	47 x 53 x 89	33 x 17.5	32 x 17.5	1096	21	25
10	YSC120H4*HA0000	12.7	116,000	140,000/200,000	80	47 x 53 x 89	33 x 17.5	32 x 17.5	1156	22	25
YSC –575/3/60 – Three Phase – High Heat											
6	YSC072HW*HA0000	12.7	75,000	84,000/120,000	80	41 x 53 x 89	33 x 17.5	32 x 17.5	936	13	20
7½	YSC090HW*HA0000	12.7	92,500	112,000/160,000	80	41 x 53 x 89	33 x 17.5	32 x 17.5	916	15	20
7½	YSC092HW*HA0000	12.7	94,800	112,000/160,000	80	47 x 53 x 89	33 x 17.5	32 x 17.5	1059	15	20
8½	YSC102HW*HA0000	12.7	107,200	112,000/160,000	80	47 x 53 x 89	33 x 17.5	32 x 17.5	1096	16	20
10	YSC120HW*HA0000	12.7	116,000	140,000/200,000	80	47 x 53 x 89	33 x 17.5	32 x 17.5	1156	22	25

Note: YSC090 and YSC102 units do not meet 2018 DOE requirements and will be sold while supplies last.

① Downflow Airflow/Horizontal Airflow

② SEER applies, 3-5 tons; EER applies 6-10 tons.

* Digit 9-E=Electromechanical or R=ReliaTel™.

** Information subject to change. Please confirm with current Product Data/Service Facts for current factory production.

For complete equipment / combination selections, installation instructions and warranty information, please refer to Product Data/Ratings and/or Installers Guides and Limited Warranty Handbooks.

Packaged Gas/Electric Convertible 3-10 Tons (Model Digit Numbers)

Digit	Description	Order Number	Digit	Description	Order Number
1-8	Main Assembly (see previous page)		20	Convenience Outlet	
9	Unit Controls			No Convenience Outlet	0
	Electromechanical	E		Unpowered Convenience Outlet	A
	ReliaTel™ Micro-processor	R		Powered Convenience Outlet (three-phase only) ⑨	B
10	Heating Capacity		21	Communications Options ③	
	Low	L		No Communications Interface	0
	Medium	M		BACnet™ Communications Interface	6
	High	H	22	Refrigeration System Option	
	Low - Stainless Steel Heat Exchanger	X		Standard Refrigeration System ⑩	0
	Medium - Stainless Steel Heat Exchanger	Y		Dehumidification Option ②②③③	B
	High - Stainless Steel Heat Exchanger	Z	23	Refrigeration Controls	
11	Minor Design Sequence			<i>Note: Applicable to Digit 7 = E, F</i>	
	First Sequence	A		No Refrigeration Control ③	0
12-13	Service Sequence			Froststat ⑪⑲	1
	First Sequence (Factory assigned)	*,*	24	Smoke Detector ⑰	
14	Fresh Air Selection			No Smoke Detector	0
	No Fresh Air	0		Return Air Smoke Detector ⑲⑳	A
	Manual Outside Air Damper 0-50% ④	A		Supply Air Smoke Detector	B
	Motorized Outside Air Damper 0-50% ⑳	B		Supply and Return Air Smoke Detectors ⑲⑳	C
	Economizer, Dry Bulb 0-100% without			Plenum Smoke Detector	D
	Barometric Relief ⑦	C	25	System Monitoring Controls	
	Economizer, Dry Bulb 0-100% with Barometric Relief ⑦ ...	D		No Monitoring Control ⑭	0
	Economizer, Reference Enthalpy 0-100% without			Clogged Filter Switch ⑭	1
	Barometric Relief ③⑦	E		Fan Failure Switch ⑭	2
	Economizer, Reference Enthalpy 0-100% with			Discharge Air Sensing Tube ⑭	3
	Barometric Relief ③⑦	F		Clogged Filter Switch and Fan Failure Switch ⑭	4
	Economizer, Comparative Enthalpy 0-100%			Clogged Filter Switch and Discharge Air Sensing Tube ⑭ ...	5
	without Barometric Relief ③⑦	G		Fan Failure Switch and Discharge Air Sensing Tube ⑭	6
	Economizer, Comparative Enthalpy 0-100%			Clogged Filter Switch, Fan Failure Switch and	
	with Barometric Relief ③⑦	H		Discharge Air Sensing Tube ⑭	7
	Low Leak Economizer, Dry Bulb			Condensate Drain Pan Overflow Switch	A
	with Barometric Relief	K		Clogged Filter Switch ⑭ and Condensate Drain	
	Low Leak Economizer, Comparative Enthalpy			Pan Overflow Switch	B
	with Barometric Relief	M		Fan Failure Switch ⑭ and Condensate Drain	
	Low Leak Economizer, Reference Enthalpy			Pan Overflow Switch	C
	with Barometric Relief	P		Discharge Air Sensing ⑭ and Condensate Drain	
15	Supply Fan/Drive Type/Motor			Pan Overflow Switch	D
	Standard Drive ⑤	0		Clogged Filter Switch ⑭, Fan Failure Switch ⑭	
	Oversized Motor	1		and Condensate Drain Pan Overflow Switch	E
	Optional Belt Drive Motor ⑩	2		Clogged Filter Switch ⑭, Discharge Air Sensing Tube ⑭	
	Single Zone VAV ⑳	6		and Condensate Drain Pan Overflow Switch	F
	Multi-Speed Indoor Fan ⑳	7		Fan Failure Switch, Discharge Air Sensing Tube ⑭ and	
	VAV Supply Air Temperature Control Standard Motor ⑳	E		Condensate Drain Pan Overflow Switch	G
16	Hinged Service Access/Filters			Clogged Filter Switch ⑭, Fan Failure Switch ⑭,	
	Standard Panels/Standard Filters	0		Discharge Air Sensing ⑭ and Condensate	
	Hinged Access Panels/Standard Filters	A		Drain Pan Overflow Switch	H
	Standard Panels/2" MERV 8 Filters	B	26	System Monitoring Controls	
	Hinged Access Panels/2" MERV 8 Filters	C		No Monitoring Controls	0
	Standard Panels/2" MERV 13 Filters	D		Demand Control Ventilation (CO ₂) ⑳⑳	A
	Hinged Access Panels/2" MERV 13 Filters	E		Fault Detection and Diagnostics (FDD)	B
17	Condenser Coil Protection			Fault Detection and Diagnostics (FDD)	
	Standard Coil	0		with Demand Control Ventilation	C
	Standard Coil with Hail Guard	1	27	Unit Hardware Enhancements	
	Black Epoxy Pre-Coated Condenser Coil ⑳	2		No Enhancements	0
	Black Epoxy Pre-Coated Condenser Coil with			Stainless Steel Drain Pan	1
	Hail Guard ⑳	3	31	Advanced Unit Controls	
	CompleteCoat™ Condenser Coil	4		Standard Unit Controls	0
	CompleteCoat™ Condenser Coil with Hail Guard	5		Human Interface	1
18	Through the Base Provisions				
	<i>Note: Applicable to Digit 1, T or Y models</i>				
	No Through-the-Base Provisions	0			
	Through-the-Base Electric ③	A			
	<i>Note: Applicable to Digit 1, Y models only</i>				
	Through-the-Base Gas Piping ③	B			
	Through-the-Base Electric and Gas Piping ③	C			
19	Disconnect/Circuit Breaker (three-phase only)				
	No Disconnect/No Circuit Breaker	0			
	Unit Mounted Non-Fused Disconnect ③	1			
	Unit Mounted Circuit Breaker ③	2			

See Footnotes ①-⑳ next page.

For complete equipment / combination selections, installation instructions and warranty information, please refer to Product Data/Ratings and/or Installers Guides and Limited Warranty Handbooks.

BUILT TO A HIGHER STANDARD™

American Standard®

HEATING & AIR CONDITIONING

Packaged Gas/Electric Convertible 3-10 Tons (Model Digit Numbers)

- ① Available on 3-5 Ton models.
 - ② Standard on 4-5 Ton E3,4,W and 6-10 Ton Heat Pumps and all High Efficiency models.
 - ③ Not available with electromechanical controls.
 - ④ Manual outside air damper will ship factory supplied within the unit, but must be field installed.
 - ⑤ High pressure control is standard on all units.
 - ⑥ On 3-5 ton, multispeed direct drive is standard on single phase and 15 SEER. On 6-10 ton, multispeed direct drive is standard on all 10 ton and 7.5-8.5 ton high efficiency. Belt drive is standard on all other units.
 - ⑦ Economizer with Barometric Relief is for downflow configured units only. Order Economizer without Barometric Relief for horizontal configuration. Barometric Relief for horizontal configured units must be ordered as field installed accessory.
 - ⑧ Through the base electric required when ordering disconnect/circuit breaker options.
 - ⑨ Requires use of Disconnect or Circuit Breaker.
- Digit 15 Selection Details**
- Digit 15 = 0**
- Standard Efficiency**
 3 Phase (3 to 5 Ton) = Multispeed Direct Drive Motor
 3 Phase (6 to 8.5 Ton) = Belt Drive
 3 Phase (10 Ton) = Ultra High Efficiency Direct Drive Plenum Fan
- High Efficiency**
 1 Phase = High Efficiency Multispeed Direct Drive Motor
 3 Phase (3 to 5 ton) = High Efficiency Multispeed Direct Drive Motor
 3 Phase (3 to 5 ton w/Dehumidification) = Belt Drive Motor
 3 Phase [6 (074) to 10 ton] = Ultra High Efficiency Direct Drive Plenum Fan
- Digit 15 = 2**
- Standard Efficiency**
 3 Phase = Not Available
- High Efficiency**
 1 Phase = Not Available
- Not Available**
 Standard Efficiency: 10 Ton w/575V
 High Efficiency: 3-5 ton w/Standard Indoor Motor w/460V
- ⑩ Standard metering devices are TXVs.
 - ⑪ Froststat cannot be field installed in electro-mechanical units.
 - ⑫ The return air smoke detector may not fit up or work properly on the Precedent units when used in conjunction with 3rd party accessories such as bolt on heat wheels, economizers and power exhaust. Do not order the return air smoke detectors when using this type of accessory.
 - ⑬ Return Air Smoke Detector cannot be ordered with Novar Controls.
 - ⑭ These options are standard when ordering Novar Controls.
 - ⑮ This option is used when ordering Novar Controls.
 - ⑯ Includes gas piping and shutoff (field assembly required).
 - ⑰ Not available with high temperature duct sensor accessory.
 - ⑱ Digit 15 = 2
 - ⑲ Novar Sensor utilized with Digit 21 = (4) Novar 3051 Controls without Zone Sensor.
 - ⑳ Available for T/Y 10 ton standard efficiency models only.
 - ㉑ Available for T/Y 3, 4, 5, 6, 7½, 8½ ton standard/high efficiency models only.
 - ㉒ Requires selection of 2" Pleated Filters (option B or C) for Digit 16.
 - ㉓ Not available on 6 ton units and all single phase or standard efficiency.
 - ㉔ Standard on T/YSC 6, 7½ (single and dual systems), 8½, 10 ton standard efficiency models and T/YHC 4, 5, 6, 7½ ton high efficiency models (except for dehumidification models).
 - ㉕ Epoxy coil and epoxy with hailguard options are not available for units with microchannel condenser coil.
 - ㉖ Single ZoneVAV is only available on 7.5-10 ton high efficiency and 10 ton standard efficiency products with ReliaTel™ controls.
 - ㉗ Multi-speed indoor fan available only on 7.5 & 8.5 ton high efficiency, and 10 ton products with ReliaTel™ controls.
 - ㉘ Motorized Outside Air Damper is not available on Multi-Speed or SZVAV (Single Zone Variable Air Volume) products.
 - ㉙ Froststat standard on Multi-Speed and SZVAV (Single Zone Variable Air Volume) products.
 - ㉚ Novar is not available with SZVAV products.
 - ㉛ Demand Control Ventilation not available with electromechanical controls.
 - ㉜ Demand Control Ventilation Option includes wiring only. The CO₂ sensor is a field-installed only option.
 - ㉝ When ordering Dehumidification option, digit #7 will revert back to E, not F.

Packaged Gas/Electric Convertible 3-10 Tons Accessories

Table LPG-9-A — Accessories

Model Number	Description	Used With ^⑩
BAYABRD001C ^③	ReliaTel™ Options Module.....	All Y*C036-120*
BAYASCT001C ^{⑦⑧}	Anti-Short-Cycle Timer.....	All Y*C036-120* w/ Electro Mechanical
BAYBARM010A ^⑨	Barometric Relief	YSC036, YHC036, YHC037
BAYBARM011A ^⑨	Barometric Relief	YSC048-120, YHC047-120
BAYBCIR001A.....	BACnet™ Communication Interface	All Y*C036-120* w/ ReliaTel™
BAYCURB042A ^②	Roof Curb.....	YSC036-060, YHC036, YHC037
BAYCURB043A ^②	Roof Curb.....	YSC072-120, YHC047-102
BAYCURB044A.....	Roof Curb.....	YHC120F
BAYDFPS003B ^{④⑤}	Clogged Filter Switch	All Y*C036-120*
BAYDFPS014A.....	Clogged Filter Switch (MERV 13 Filter.....)	All Y*C036-120*
BAYDFPS004 ^{④⑤}	Fan Failure Switch.....	All Y*C036-120*
BAYDMPR053B0.....	0-50% Manual Outside Air Damper	YSC036, YHC036, YHC037
BAYDMPR056B0.....	0-50% Manual Outside Air Damper	YSC048-120, YHC047-120
BAYDMPR051A ^③	0-50% Motorized Outside Air Damper	YSC036, YHC036, YHC037 (ReliaTel™)
BAYDMPR052B ^⑦	0-50% Motorized Outside Air Damper	YSC036, YHC036 (Electro Mechanical)
BAYDMPR054A ^③	0-50% Motorized Outside Air Damper	YSC048-120, YHC047-120 (ReliaTel™)
BAYDMPR055B ^⑦	0-50% Motorized Outside Air Damper	YSC048-120, YHC048-120(Electro Mechanical)
BAYECON085A ^③	0-100% Dry Bulb Economizer.....	YSC036, YHC036, YHC037 (ReliaTel™)
BAYECON086B ^⑦	0-100% Dry Bulb Economizer.....	YSC036, YHC036 (Electro Mechanical)
BAYECON087A ^③	0-100% Dry Bulb Economizer.....	YSC048-120, YHC047-120 (ReliaTel™)
BAYECON088B ^⑦	0-100% Dry Bulb Economizer.....	YSC048-120, YHC048-120 (Electro Mechanical)
BAYECON704A.....	Downflow Low Leak Economizer	YSC048-120, YHC047-120 (ReliaTel™)
BAYECON705B.....	Downflow Low Leak Economizer	YSC036, YHC036, YHC037 (ReliaTel™)
BAYENTH300A.....	Reference Enthalpy Kit (Solid State	BAYECON086A, 088A (Electro-Mechanical)
BAYENTH301A.....	Comparative Enthalpy Kit (Solid State	BAYECON086A, 088A (Electro-Mechanical)
BAYENTH005A ^①	Reference Enthalpy Kit.....	BAYECON085A, 087A (ReliaTel™)
BAYENTH006B ^①	Comparative Enthalpy Kit.....	BAYECON086A, 087A (ReliaTel™)
BAYFRST003A ^{③④}	High Temperature Stat	All Y*C036-120*
BAYGARD237A.....	Condenser Coil Hail Guard	YHC036, YHC037
BAYGARD240A.....	Condenser Coil Hail Guard	YSC072-090, YHC047-067
BAYGARD241A.....	Condenser Coil Hail Guard	YSC092-120
BAYGARD270A.....	Condenser Coil Hail Guard	YHC120
BAYGARD437A.....	Condenser Coil Hail Guard	YSC036-060
BAYGARD241A.....	Condenser Coil Hail Guard	YHC072-102
BAYHAKT011A.....	High Altitude Kit	YSC036-060G
BAYHAKT010E.....	High Altitude Kit	YSC072-120, YHC036-120

- ① Kits contain all necessary parts to achieve desired level of enthalpy control.
- ② Lynn Haven Manufacturing has a No-Return policy for this roof curb.
- ③ For use with ReliaTel™ controlled units only.
- ④ Cannot be used in conjunction with factory installed Smoke Detector option.
- ⑤ Installs in ductwork for horizontal configuration. For downflow configuration, it installs in the unit's horizontal return duct. See Installer's Guide for more information.
- ⑥ BAYABRD001C is required when ordering field installed accessories Clogged Filter Switch (BAYDFPS003A), Fan Fail Switch (BAYDFPS004A), Discharge Air Sensing Kit (BAYTUBE004A or BAYTUBE005A) or Evaporator Defrost Control (Frostat) (BAYLOAM020B) Ventilation Override Kit (BAYVNOR001B) unless the following options are factory installed: Frostat, Smoke Detector, Clogged Filter Switch, Fan Failure Switch, Discharge Air Sensing Kit. **These factory installed options include the ReliaTel™ Options Module.**
- ⑦ Electromechanical controlled units only
- ⑧ Activated on Power on.
- ⑨ Field installed accessory. Requires an economizer.
- ⑩ The manual outside air damper will ship factory supplied within the unit, but must be field installed.
- ⑪ A=R-22, E=410A

BUILT TO A HIGHER STANDARD[®]

American Standard[®]
HEATING & AIR CONDITIONING

Packaged Gas/Electric Convertible 3-10 Tons Accessories

Table LPG-10-A — Accessories

Model Number	Description	Used With [®]
BAYHSMT082A	2 HP Oversized motor kit (208-230/460V	YSC072F3, 4
BAYHSMT083A	2 HP Oversized motor kit (575V	YSC072FW
BAYHSMT402A	2 HP Oversized motor kit	YHC072F3, 4
BAYHSMT086A	3 HP Oversized motor kit (208-230/460V	YSC090-102F3, 4
BAYHSMT087A	3 HP Oversized motor kit (575V	YSC090-102FW
BAYLSDR009A	Low Static Drive Kit	YHC072F
BAYHSDR012A	High Static Drive Kit	YSC072F
BAYLMSW001A ^①	Power Exhaust Limit Switch	All Y*C036-120*
BAYLOAM020B1 ^⑤	Evaporator Defrost Control (Frostat)	YHC036-067E*R,
BAYLOAM120A	Evaporator Defrost Control (Frostat)	YSC036-060G*R (ReliaTel™)
BAYLTCI002B ^④	LonTalk [®] Communications Interface (LCI	All Y*C036-120*, R (ReliaTel™)
BAYLPKT029D ^④	LP Conversion Kit	YSC036-060*L/M/H, YSC072*H, YSC090-102*M/M/H, YSC120*L/M/H, YHC072*H, YHC092-102*M/M/H, YHC120*L/M/H
BAYLPKT050C ^⑤	LP Conversion Kit	YSC072*L/M, YSC090-102*L, YHC036-0060*L/M/H, YHC072*L/M, YHC0992-102*L
BAYPWRX026A	Power Exhaust (208-230/3 VAC	YSC072-120*3, YHC047-120*3
BAYPWRX027A	Power Exhaust (460/3 VAC	YSC072-120*4, YHC047-120*4
BAYPWRX028A	Power Exhaust (575/3 VAC	YSC072-120*W, YHC047-120*W
BAYPWRX070A	Power Exhaust (208-230/3 VAC	YSC036-060*3, YHC036*3, YHC037*3
BAYPWRX071A	Power Exhaust (460/3 VAC	YSC036-060*4, YHC036*4, YHC037*4
BAYPWRX072A	Power Exhaust (575/3 VAC	YSC036-060*W
BAYQACB009A ^{②⑤}	Quick Adapt Roof Curb	YSC036-060, YHC036, YHC037
BAYQACB010A ^{②⑤}	Quick Adapt Roof Curb	YSC036-060, YHC036, YHC037
BAYQACB011A ^{②⑦}	Quick Adapt Roof Curb	YSC072-120, YHC047-102
BAYQACB012A ^{②⑦}	Quick Adapt Roof Curb	YSC072-120, YHC047-102
BAYQACB013A ^{②⑦}	Quick Adapt Roof Curb	YSC072-120, YHC047-102
BAYQACB114A ^{②⑥}	Quick Adapt Roof Curb	YSC072-120H, YHC048-102H
BAYQACB115A ^{②⑦}	Quick Adapt Roof Curb	YSC072-120H, YHC048-102H
BAYRTEM001A ^②	Fully Featured ReliaTel™ Economizer Logic Model	All Y*C036-120*
BAYSENS016A ^④	Temperature Sensor	All Y*C036-120*
BAYSENS250A3 ^③	CO2 Duct Mounted, Sensor Only	All Y*C036-120*, R (ReliaTel™)
BAYSENS251A3 ^③	CO2 Wall Mounted, Sensor Only	All Y*C036-120*, R (ReliaTel™)
BAYSERV001A ^④	Selective Resistance Service Tester	All Y*C036-120*
BAYSTAT0234	Remote Potentiometer	All Y*C036-120*
BAYTUBE004A ^{②④⑤}	Discharge Air Sensing Kit	YHC036-037*R
BAYTUBE006A ^{②④⑤}	Discharge Air Sensing Kit	YSC072-102*R, YHC047-072*R
BAYTUBE104A	Discharge Air Sensing Kit	YSC036-060*R
BAYTUBE400A	Discharge Air Sensing Kit	YSC120*R
BAYTUBE402A	Discharge Air Sensing Kit	YHC120*R
BAYVNOR001B ^{④⑤⑥}	Ventilation Override Kit	All Y*C036-120*

- ① For use with ReliaTel™ microprocessor controlled units only. Must be factory installed for Electromechanical controlled units.
- ② Used for true discharge air sensing in both heating and cooling. Required for supply air tempering.
- ③ Lynn Haven Manufacturing has a No-Return policy for this roof curb.
- ④ For use with ReliaTel™ controlled units only.
- ⑤ BAYABRD001C is required when ordering field installed accessories Clogged Filter Switch (BAYDFPS003A), Fan Fail Switch (BAYDFPS004A), Discharge Air Sensing Kit (BAYTUBE004A or BAYTUBE005A) or Evaporator Defrost Control (Frostat) (BAYLOAM020B) Ventilation Override Kit (BAYVNOR001B) unless the following options are factory installed: Frostat, Smoke Detector, Clogged Filter Switch, Fan Failure Switch, Discharge Air Sensing Kit. **These factory installed options include the ReliaTel™ Options Module.**
- ⑥ BAYQACB009A adapts Voyager BAYCURB021B to accept Precedent 3 -5 ton unit. BAYQACB010A adapts Voyager BAYCURB022B to accept Precedent 3-5 ton unit. BAYQACB012A adapts Voyager BAYCURB025B to accept Precedent 6-10 ton unit. BAYQACB013A adapts Voyager BAYCURB026B to accept Precedent 6-10 ton unit. BAYQACB011A adapts Voyager BAYCURB022B to accept Precedent 6-10 ton unit.
- ⑦ Interface allows 3-10 ton units with ReliaTel™ Controls to communicate with Tracer 100, Tracker, VariTrac II, and is the preferred method of communication to Tracer Summit.
- ⑧ Power Exhaust cannot be used with Barometric Relief. Order Economizer without Barometric Relief.
- ⑨ Field installed accessory. Requires an economizer.
- ⑩ A=R-22, E=410A
- ⑪ When ordering a field installed power exhaust on a unit with electromechanical controls, BAYLMSW001A must be ordered.
- ⑫ If any version of comparative or reference enthalpy is ordered, BAYRTEM001A does not need to be ordered.
- ⑬ Order only when unit has factory installed Demand Control Ventilation option.
- ⑭ BAYLPKT029 is for 2 stage gas units. If 036-060 model has digit 7=G AND digit 11=B, it's a 2 stage gas unit. Use BAYLPKT029.
- ⑮ BAYLPKT050 is for 1 stage gas units. If 036-060 model has digit 7=G AND digit 11=A, it's a 1 stage gas unit. Use BAYLPKT050.
- ⑯ Precedent E cabinet to Precedent D cabinet (BAYCURB044 to BAYCURB043)
- ⑰ Precedent B cabinet to Precedent C cabinet (BAYCURB042 to BAYCURB043)

For complete equipment / combination selections, installation instructions and warranty information, please refer to Product Data/Ratings and/or Installers Guides and Limited Warranty Handbooks.

Packaged Gas/Electric Convertible 3-10 Tons, R-410A Zone Sensors / Thermostats

Table LPG-11-A — Zone Sensors for ReliaTel™ Controlled Units

Model Number	Description	Used With
ASYSTAT106A	Single Setpoint Manual Changeover	Y*C036-120*, R
ASYSTAT107A	Single Setpoint Y*C036-120*, R	
ASYSTAT108A	Dual Setpoint Manual or Auto Changeover	Y*C036-120*, R
ASYSTAT109A	Dual Setpoint Changeover Sensor	Y*C036-120*, R
ASYSTAT111A	Remote Room Sensor Y*C036*120*, R	
ASYSTAT777A	Programmable Night Setback w/System Function Lights (Vertical Style)	Y*C036-120*, R
ASYSTAT708A	Programmable Night Setback w/System Function Lights	Y*C036-120*, R
ASYSTAT710A	Wall Mounted Humidity Sensor	Y*C036-120*
ASYSTAT711A	Duct Mounted Humidity Sensor	Y*C036-120*
BAYMTPL110A	Retrofit Wall Cover Plate Kit 7.25" x 6.0"	ASYSTAT666C
BAYSENS924A	Title 24 Zone Sensor ^①	All

① Must be used with ReliaTel™ Control and BCI Communications Interface.

**For additional Controls Information:
 See ReliaTel™ and Micro Control features on LPC-12 and LPC-13.**

BUILT TO A HIGHER STANDARD[®]

American Standard[®]
HEATING & AIR CONDITIONING

Packaged Gas/Electric with ReliaTel™ Controls 12½-25 Tons, R-410A

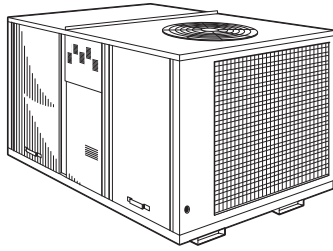

12½ - 25 Ton YHD-G — Downflow
12½ - 25 Ton YHH-G — Horizontal

- Scroll compressors on all units
 - **ReliaTel™** control features are listed on page LPC-12
 - Operating charge of R-410A
 - Built-in anti-short cycle timer, time delay relay and minimum on time controls
 - Low Ambient to 0°F standard
 - High efficiency drum and tube heat exchanger (12½ - 25 tons)
 - Color coded and numbered wiring
 - 2" throwaway filters
 - Simple U-shaped airflow pattern results in very low airside energy requirement
 - Quick-Access doors and single side access
- make servicing much faster for lower maintenance costs
- Quick-adjust idler arm pulley. Adjust belt tension, change belts, adjust airflow quickly
 - High efficiency gas heat with hot surface ignition for low heating energy costs, low maintenance and high reliability
 - Sloped sheet metal drain pans
 - **5-year limited compressor warranty (12 ½ - 25 tons)**
 - **5-year limited heat exchanger warranty (12 ½ - 17 ½ tons)**
 - **1-year limited warranty (20 - 25 tons)**

Table LPG-12-A — High Efficiency ReliaTel™ Units (R-410A)

Tons	Unit Model No	Power Supply Volts/Phase/Hz	Performance IEER ^①	Cooling Capacity (Btuh)	Heating Output Capacity (Btuh)	Dimensions (in.) H x W x L	Shipping Weight (lbs.)	MCA**	Max Fuse Size or Max Circuit Breaker**	Downflow ^①	Roofcurb
YH* - Three Phase Low Heat											
12½	YH*150G3RLB0000	208-230/3/60	13.5	144,000	120,000	54 x 85 ⁵ / ₁₆ x 122 ⁵ / ₁₆	2691	65	90	BAYCURB027B	
15	YH*180G3RLB0000	208-230/3/60	14.0	174,000	200,000	64 ¹ / ₈ x 85 ⁵ / ₁₆ x 122 ⁵ / ₁₆	2660	68	90	BAYCURB027B	
17½	YH*210G3RLB0000	208-230/3/60	13.0	204,000	200,000	64 ¹ / ₈ x 85 ⁵ / ₁₆ x 122 ⁵ / ₁₆	2619	86	110	BAYCURB027B	
20	YH*240G3RLB0000	208-230/3/60	12.4	234,000	200,000	64 ¹ / ₈ x 85 ⁵ / ₁₆ x 122 ⁵ / ₁₆	2690	99	125	BAYCURB027B	
25	YH*300G3RLB0000	208-230/3/60	12.4	274,000	200,000	64 ¹ / ₈ x 85 ⁵ / ₁₆ x 122 ⁵ / ₁₆	2719	121	150	BAYCURB027B	
12½	YH*150G4RLB0000	460/3/60	13.5	144,000	120,000	54 x 85 ⁵ / ₁₆ x 122 ⁵ / ₁₆	2691	30	40	BAYCURB027B	
15	YH*180G4RLB0000	460/3/60	14.0	174,000	200,000	64 ¹ / ₈ x 85 ⁵ / ₁₆ x 122 ⁵ / ₁₆	2660	33	45	BAYCURB027B	
17½	YH*210G4RLB0000	460/3/60	13.0	204,000	200,000	64 ¹ / ₈ x 85 ⁵ / ₁₆ x 122 ⁵ / ₁₆	2619	43	60	BAYCURB027B	
20	YH*240G4RLB0000	460/3/60	12.4	234,000	200,000	64 ¹ / ₈ x 85 ⁵ / ₁₆ x 122 ⁵ / ₁₆	2690	46	60	BAYCURB027B	
25	YH*300G4RLB0000	460/3/60	12.4	274,000	200,000	64 ¹ / ₈ x 85 ⁵ / ₁₆ x 122 ⁵ / ₁₆	2719	57	70	BAYCURB027B	
12½	YH*150GWRLB0000	575/3/60	13.5	144,000	120,000	54 x 85 ⁵ / ₁₆ x 122 ⁵ / ₁₆	2691	24	30	BAYCURB027B	
15	YH*180GWRLB0000	575/3/60	14.0	174,000	200,000	64 ¹ / ₈ x 85 ⁵ / ₁₆ x 122 ⁵ / ₁₆	2660	26	35	BAYCURB027B	
17½	YH*210GWRLB0000	575/3/60	13.0	204,000	200,000	64 ¹ / ₈ x 85 ⁵ / ₁₆ x 122 ⁵ / ₁₆	2619	33	45	BAYCURB027B	
20	YH*240GWRLB0000	575/3/60	12.4	234,000	200,000	64 ¹ / ₈ x 85 ⁵ / ₁₆ x 122 ⁵ / ₁₆	2690	38	50	BAYCURB027B	
25	YH*300GWRLB0000	575/3/60	12.4	274,000	200,000	64 ¹ / ₈ x 85 ⁵ / ₁₆ x 122 ⁵ / ₁₆	2719	44	50	BAYCURB027B	
YH* - Three Phase High Heat											
12½	YH*150G3RHB0000	208-230/3/60	13.5	144,000	200,000	54 x 85 ⁵ / ₁₆ x 122 ⁵ / ₁₆	2691	65	90	BAYCURB027B	
15	YH*180G3RHB0000	208-230/3/60	14.0	174,000	280,000	64 ¹ / ₈ x 85 ⁵ / ₁₆ x 122 ⁵ / ₁₆	2660	68	90	BAYCURB027B	
17½	YH*210G3RHB0000	208-230/3/60	13.0	204,000	280,000	64 ¹ / ₈ x 85 ⁵ / ₁₆ x 122 ⁵ / ₁₆	2619	86	110	BAYCURB027B	
20	YH*240G3RHB0000	208-230/3/60	12.4	234,000	320,000	64 ¹ / ₈ x 85 ⁵ / ₁₆ x 122 ⁵ / ₁₆	2690	99	125	BAYCURB027B	
25	YH*300G3RHB0000	208-230/3/60	12.4	274,000	320,000	64 ¹ / ₈ x 85 ⁵ / ₁₆ x 122 ⁵ / ₁₆	2719	121	150	BAYCURB027B	
12½	YH*150G4RHB0000	460/3/60	13.5	144,000	200,000	54 x 85 ⁵ / ₁₆ x 122 ⁵ / ₁₆	2691	30	40	BAYCURB027B	
15	YH*180G4RHB0000	460/3/60	14.0	174,000	280,000	64 ¹ / ₈ x 85 ⁵ / ₁₆ x 122 ⁵ / ₁₆	2660	33	45	BAYCURB027B	
17½	YH*210G4RHB0000	460/3/60	13.0	204,000	280,000	64 ¹ / ₈ x 85 ⁵ / ₁₆ x 122 ⁵ / ₁₆	2619	43	60	BAYCURB027B	
20	YH*240G4RHB0000	460/3/60	12.4	234,000	320,000	64 ¹ / ₈ x 85 ⁵ / ₁₆ x 122 ⁵ / ₁₆	2690	46	60	BAYCURB027B	
25	YH*300G4RHB0000	460/3/60	12.4	274,000	320,000	64 ¹ / ₈ x 85 ⁵ / ₁₆ x 122 ⁵ / ₁₆	2719	57	70	BAYCURB027B	
12½	YH*150GWRHB0000	575/3/60	13.5	144,000	200,000	54 x 85 ⁵ / ₁₆ x 122 ⁵ / ₁₆	2691	24	30	BAYCURB027B	
15	YH*180GWRHB0000	575/3/60	14.0	174,000	280,000	64 ¹ / ₈ x 85 ⁵ / ₁₆ x 122 ⁵ / ₁₆	2660	26	35	BAYCURB027B	
17½	YH*210GWRHB0000	575/3/60	13.0	204,000	280,000	64 ¹ / ₈ x 85 ⁵ / ₁₆ x 122 ⁵ / ₁₆	2619	33	45	BAYCURB027B	
20	YH*240GWRHB0000	575/3/60	12.4	234,000	320,000	64 ¹ / ₈ x 85 ⁵ / ₁₆ x 122 ⁵ / ₁₆	2690	38	50	BAYCURB027B	
25	YH*300GWRHB0000	575/3/60	12.4	274,000	320,000	64 ¹ / ₈ x 85 ⁵ / ₁₆ x 122 ⁵ / ₁₆	2719	44	50	BAYCURB027B	

① For Downflow units only.

② 278,000 in the Horizontal airflow configuration.

③ Downflow/Horizontal

* Digit 3 D=Downflow or H=Horizontal.

** Information subject to change. Please confirm with current Product Data/Service Facts for current factory production.

For complete equipment / combination selections, installation instructions and warranty information, please refer to Product Data/Ratings and/or Installers Guides and Limited Warranty Handbooks.

Packaged Gas/Electric with ReliaTel™ Controls 12½-25 Tons, R-410A

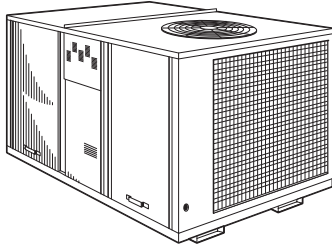

12½ - 25 Ton YSD-F — Downflow
12½ - 25 Ton YSH-F — Horizontal

- Scroll compressors on all units
- **ReliaTel™** control features are listed on page LPC-12
- Operating charge of R-410A
- Built-in anti-short cycle timer, time delay relay and minimum on time controls
- Low Ambient to 0°F standard
- High efficiency drum and tube heat exchanger (12½ - 25 tons)
- Color coded and numbered wiring
- 2" throwaway filters
- Simple U-shaped airflow pattern results in very low airside energy requirement
- Quick-Access doors and single side access

make servicing much faster for lower maintenance costs

- Quick-adjust idler arm pulley. Adjust belt tension, change belts, adjust airflow quickly
- High efficiency gas heat with hot surface ignition for low heating energy costs, low maintenance and high reliability
- Sloped sheet metal drain pans
- **5-year limited compressor warranty (12 ½ - 25 tons)**
- **5-year limited heat exchanger warranty (12 ½ - 17 ½ tons)**
- **1-year limited warranty (20 - 25 tons)**

Table LPG-13-A — Standard Efficiency ReliaTel™ Units (R-410A)

Tons	Unit Model No.	Power Supply Volts/Phase/Hz	Performance IEER	Capacity (Btuh)	Cooling Capacity (Btuh)	Heating Output Dimensions (in.) H x W x L	Shipping Weight (lbs.)	MCA**	Max Fuse Size or Max Circuit Breaker**	Downflow ^① Roofcurb
YS* - Three Phase Low Heat										
12½	YS*150G3RLA0000	208-230/3/60	12.2	140,000	122,000	50⅞ x 71⅝ x 107⅝ ₁₆	1781	61	80	BAYCURB026B
15	YS*180G3RLA0000	208-230/3/60	12.2	176,000	203,000	54 x 85⅝ ₁₆ x 122⅝ ₁₆	2281	69	90	BAYCURB027B
17½	YS*210G3RLA0000	208-230/3/60	12.2	193,000	203,000	54 x 85⅝ ₁₆ x 122⅝ ₁₆	2292	77	100	BAYCURB027B
20	YS*240G3RLA0000	208-230/3/60	11.4	240,000	203,000	54 x 85⅝ ₁₆ x 122⅝ ₁₆	2353	105	125	BAYCURB027B
25	YS*300G3RLA0000	208-230/3/60	11.4	272,000	203,000	54 x 85⅝ ₁₆ x 122⅝ ₁₆	2337	112	150	BAYCURB027B
12½	YS*150G4RLA0000	460/3/60	12.2	140,000	122,000	50⅞ x 71⅝ x 107⅝ ₁₆	1781	29	40	BAYCURB026B
15	YS*180G4RLA0000	460/3/60	12.2	176,000	203,000	54 x 85⅝ ₁₆ x 122⅝ ₁₆	2281	36	50	BAYCURB027B
17½	YS*210G4RLA0000	460/3/60	12.2	193,000	203,000	54 x 85⅝ ₁₆ x 122⅝ ₁₆	2292	39	50	BAYCURB027B
20	YS*240G4RLA0000	460/3/60	11.4	240,000	203,000	54 x 85⅝ ₁₆ x 122⅝ ₁₆	2353	51	70	BAYCURB027B
25	YS*300G4RLA0000	460/3/60	11.4	272,000	203,000	54 x 85⅝ ₁₆ x 122⅝ ₁₆	2337	55	70	BAYCURB027B
12½	YS*150GWRLA0000	575/3/60	12.2	140,000	122,000	50⅞ x 71⅝ x 107⅝ ₁₆	1781	22	30	BAYCURB026B
15	YS*180GWRLA0000	575/3/60	12.2	176,000	203,000	54 x 85⅝ ₁₆ x 122⅝ ₁₆	2281	30	40	BAYCURB027B
17½	YS*210GWRLA0000	575/3/60	12.2	193,000	203,000	54 x 85⅝ ₁₆ x 122⅝ ₁₆	2292	34	45	BAYCURB027B
20	YS*240GWRLA0000	575/3/60	11.4	240,000	203,000	54 x 85⅝ ₁₆ x 122⅝ ₁₆	2353	43	60	BAYCURB027B
25	YS*300GWRLA0000	575/3/60	11.4	272,000	203,000	54 x 85⅝ ₁₆ x 122⅝ ₁₆	2337	45	60	BAYCURB027B
YS* - Three Phase High Heat										
12½	YS*150G3RHA0000	208-230/3/60	12.2	140,000	203,000	50⅞ x 71⅝ x 107⅝ ₁₆	1781	61	80	BAYCURB026B
15	YS*180G3RHA0000	208-230/3/60	12.2	176,000	284,000	54 x 85⅝ ₁₆ x 122⅝ ₁₆	2281	69	90	BAYCURB027B
17½	YS*210G3RHA0000	208-230/3/60	12.2	193,000	284,000	54 x 85⅝ ₁₆ x 122⅝ ₁₆	2292	77	100	BAYCURB027B
20	YS*240G3RHA0000	208-230/3/60	11.4	240,000	324,000	54 x 85⅝ ₁₆ x 122⅝ ₁₆	2353	105	125	BAYCURB027B
25	YS*300G3RHA0000	208-230/3/60	11.4	272,000	324,000	54 x 85⅝ ₁₆ x 122⅝ ₁₆	2337	112	150	BAYCURB027B
12½	YS*150G4RHA0000	460/3/60	12.2	140,000	203,000	50⅞ x 71⅝ x 107⅝ ₁₆	1781	29	40	BAYCURB026B
15	YS*180G4RHA0000	460/3/60	12.2	176,000	284,000	54 x 85⅝ ₁₆ x 122⅝ ₁₆	2281	36	50	BAYCURB027B
17½	YS*210G4RHA0000	460/3/60	12.2	193,000	284,000	54 x 85⅝ ₁₆ x 122⅝ ₁₆	2292	39	50	BAYCURB027B
20	YS*240G4RHA0000	460/3/60	11.4	240,000	324,000	54 x 85⅝ ₁₆ x 122⅝ ₁₆	2353	51	70	BAYCURB027B
25	YS*300G4RHA0000	460/3/60	11.4	272,000	324,000	54 x 85⅝ ₁₆ x 122⅝ ₁₆	2337	55	70	BAYCURB027B
12½	YS*150GWRHA0000	575/3/60	12.2	140,000	203,000	50⅞ x 71⅝ x 107⅝ ₁₆	1781	22	30	BAYCURB026B
15	YS*180GWRHA0000	575/3/60	12.2	176,000	284,000	54 x 85⅝ ₁₆ x 122⅝ ₁₆	2281	30	40	BAYCURB027B
17½	YS*210GWRHA0000	575/3/60	12.2	193,000	284,000	54 x 85⅝ ₁₆ x 122⅝ ₁₆	2292	34	45	BAYCURB027B
20	YS*240GWRHA0000	575/3/60	11.4	240,000	324,000	54 x 85⅝ ₁₆ x 122⅝ ₁₆	2353	43	60	BAYCURB027B
25	YS*300GWRHA0000	575/3/60	11.4	272,000	324,000	54 x 85⅝ ₁₆ x 122⅝ ₁₆	2337	45	60	BAYCURB027B

① For Downflow units only.

* Digit 3 D=Downflow or H=Horizontal.

** Information subject to change. Please confirm with current Product Data/Service Facts for current factory production.

BUILT TO A HIGHER STANDARD™

American Standard
HEATING & AIR CONDITIONING

Packaged Cooling with ReliaTel™ Controls 12½-25 Tons (Model Digit Numbers)

Digit	Description	Order Number	Digit	Description	Order Number
1	Unit Type		19	Disconnect Switch/Circuit Breaker	
	Packaged Cooling, Electric Heat.....	T		No Disconnect/circuit break.....	0
2	Efficiency	Packaged Gas/Electric.....	Y	Unit Mounted Non-Fused Disconnect Switch.....	1
		Standard Efficiency.....	S	Unit Mounted Circuit Breaker.....	2
3	Airflow Configuration	High Efficiency.....	H	Convenience Outlet Option	
		Downflow.....	D	Without Convenience Outlet.....	0
4-6	Nominal Gross Cooling Capacity (MBh)	Horizontal.....	H	Unpowered Convenience Outlet.....	A
		12½ Tons.....	150	Powered Convenience Outlet.....	B
		15 Tons.....	180	Communications Options	
		17½ Tons.....	210	Without Communications Options.....	0
		20 Tons.....	240	Novar 2024 Controls Interface④.....	3
7	Major Design Sequence	25 Tons.....	300	Novar 3051 Controls Interface④.....	4
		Microchannel Type Condenser Coils.....	F	Novar 3051 Communications Interface with Demand Control Ventilation④.....	5
8	Voltage Selection	208-230/60/3.....	3	Building Automation Control Network Communications Interface.....	6
		460/60/3.....	4	Refrigeration System Option	
		575/60/3.....	W	Standard refrigeration system.....	0
		380/60/3.....	K	Thermal Expansion Valve (TXV).....	A
		380/60/3.....	K	Dehumidification (Hot Gas Reheat).....	B
9	Unit Controls	ReliaTel™.....	R	Refrigeration Controls	
		Heating Capacity		Without Refrigeration Controls.....	0
10	Heating Capacity	No Heat②.....	0	Frostat.....	1
		18 kW Electric Heat②.....	G	Smoke Detector	
		27 kW Electric Heat②.....	K	Without Smoke Detector.....	0
		36 kW Electric Heat②.....	N	Return Air Smoke Detector.....	A
		54 kW Electric Heat②.....	P	Supply Air Smoke Detector.....	B
		72 kW Electric Heat②.....	R	Return/Supply Air Smoke Detector.....	C
		Gas Heat - High①.....	H	Plenum Smoke Detector.....	D
		Gas Heat - Low①.....	L	System Monitoring Controls	
		Gas Heat - SS Ht Ex - Modulating①.....	V	No Monitoring Controls.....	0
		Gas Heat - SS Ht Ex - Low①.....	X	Clogged Filter Switch.....	1
		Gas Heat - SS Ht Ex - High①.....	Z	Fan Failure Switch.....	2
11	Minor Design Sequence		3	Discharge Air Sensing.....	3
12-13	Service Sequence		4	Clogged Filter Switch and Fan Failure switch.....	4
14	Fresh Air Selection	No Fresh Air.....	0	Clogged Filter Switch and Discharge Air Sensing.....	5
		Econ Dry Bulb w/ Barometric Relief.....	D	Fan Failure Switch and Discharge Air Sensing.....	6
		Econ Reference Enthalpy w/Barometric Relief.....	F	Clogged Filter Switch, Fan Failure Switch and Discharge Air Sensing.....	7
		Econ Comparative Enthalpy w/Barometric Relief.....	H	Discharge Air Sensing.....	7
		Low Leak Economizer, Dry Bulb with Barometric Relief.....	K	NOVAR Return Air Sensor (Novar 2024)④.....	8
		Low Leak Economizer, Comparative Enthalpy with Barometric Relief.....	M	NOVAR Zone Temp Sensor(Novar 3051)④.....	9
		Low Leak Economizer, Reference Enthalpy with Barometric Relief.....	P	Condensate Drain Pan Overflow Switch.....	A
		Supply Fan/Drive Type/Motor		Clogged Filter Switch and Condensate Drain Pan Overflow Switch.....	B
		Standard Motor.....	0	Fan Failure Switch and Condensate Drain Pan Overflow Switch.....	C
		Oversized Motor.....	1	Discharge Air Sensing and Condensate Drain Pan Overflow Switch.....	D
High Efficiency Motor.....	3	Clogged Filter Switch, Fan Failure Switch and Condensate Drain Pan Overflow Switch.....	E		
Single Zone Variable Air Volume Standard Motor.....	6	Clogged Filter Switch, Discharge Air Sensing Tube and Condensate Drain Pan Overflow Switch.....	F		
Multi-Speed Standard Motor.....	7	Fan Failure Switch, Discharge Air Sensing Tube and Condensate Drain Pan Overflow Switch.....	G		
Single Zone Variable Air Volume Oversized Motor.....	8	Clogged Filter Switch, Fan Failure Switch, Discharge Air Sensing and Condensate Drain Pan Overflow Switch.....	H		
Multi-Speed Oversized Motor.....	9	System Monitoring Controls			
Single Zone Variable Air Volume Standard Motor w/Shaft Ground Ring.....	A	No Monitoring Controls.....	0		
Multi-Speed Standard Motor w/Shaft Ground Ring.....	B	Demand Control Ventilation (CO₂)⑤.....	A		
Single Zone Variable Air Volume Oversized Motor w/Shaft Ground Ring.....	C	Fault Detection and Diagnostics (FDD).....	B		
Multi-Speed Oversized Motor w/Shaft Ground Ring.....	D	Fault Detection and Diagnostics (FDD) with Demand Control Ventilation.....	C		
16	Hinged Service Access / Filters	Standard Panels/Standard Filters.....	0	Unit Hardware Enhancements	
		Hinged Access/Standard Filters.....	A	No Enhancements.....	0
		Standard Panels/MERV 8 Filters.....	B	Stainless Steel Drain Pan.....	1
		Hinged Access/MERV 8 Filters.....	C	Short Circuit Current Rating (SCCR)	
		Standard Panels/MERV 13 Filters.....	D	Standard SCCR.....	0
Hinged Access/MERV 13 Filters.....	E	65 kA SCCR.....	A		
17	Condenser Coil Protection	Standard Coil.....	0	Advanced Unit Controls	
		Standard Coil With Hail Guard.....	1	Standard Unit Controls.....	0
		CompleteCoat™ Condenser Coil.....	4	Human Interface.....	1
		CompleteCoat™ Condenser Coil with Hail Guard.....	5	Through The Base Provisions	
		No Through The Base Provisions③.....	0	Through The Base Electric③.....	A
18	Through The Base Provisions	Through The Base Electric③.....	A	Through The Base Gas①.....	B
		Through The Base Gas①.....	B	Through The Base Electric/Gas①.....	C
		Through The Base Electric/Gas①.....	C	Through The Base Access①.....	D
		Through The Base Access①.....	D		

① Applicable to Digit 1 Y models only.
 ② Applicable to Digit 1 T models only.
 ③ Applicable to Digit 1, T or Y models.

④ Novar is not available with SZ VAV products.
 ⑤ Demand Control Ventilation Option includes wiring only. The CO₂ sensor is a field-installed only option.

Note: Most Factory Installed Options available for Downflow Air Discharge units only. Please verify with ordering system for availability.

For complete equipment / combination selections, installation instructions and warranty information, please refer to Product Data/Ratings and/or Installers Guides and Limited Warranty Handbooks.

Packaged Gas/Electric with ReliaTel™ Controls 12½-25 Tons Accessories

Table LPG-15-A — Field Installed Accessories

Model Number	Description	Used With
BAYABRD002B ^⑥	ReliaTel™ Options Module	All Voyagers
BAYBCIR001A	Bacnet™ Communication Interface	ReliaTel™ Controller (BCI-R)
BAYCO2K002B	CO ₂ Sensor Wall Mounted	All Voyagers
BAYCO2K004B	CO ₂ Sensor Duct Mounted	All Voyagers
BAYCURB026B ^{⑥⑥}	Downflow Only Roof Curb	YSD150F
BAYCURB027B ^{⑥⑥}	Downflow Only Roof Curb	YHD150-YHD300F, YSD180-YSD300F
BAYDFPS005A ^{⑦⑧}	Clogged Filter Switch (MERV 7)	All Voyagers
BAYDFPS006A ^{⑦⑧}	Fan Failure Switch	All Voyagers
BAYDFPS031A	Clogged Filter Switch (MERV 13)	All Voyagers
BAYDMPR029C	0-25% Manual Outside Air Damper	All Voyagers
BAYDMPR057A	0-50% Motorized Outside Air Damper	YSD150F
BAYDMPR058A	0-50% Motorized Outside Air Damper	YHD150-300F, YSD150-300F
BAYECON089A ^⑨	Downflow Economizer with Barometric Relief	YSD150F
BAYECON090A ^⑨	Downflow Economizer with Barometric Relief	YHD150-300F, YSD150-300F
BAYECON091A	Horizontal Economizer	YSH150F
BAYECON092A	Horizontal Economizer	YHH150-300F, YSH180-300F
BAYECON700A	Downflow Low Leak Economizer	YSD150F
BAYECON701A	Downflow Low Leak Economizer	YSD180F-300F, YHD150F, YHD180-300F
BAYENTH007A ^{①②}	Reference Enthalpy Kit	All BAYECON089A-092A
BAYENTH008A ^{①③}	Comparative Enthalpy Kit	All BAYECON089A-092A
BAYFRST003A	High Temperature Stat	All Voyagers
BAYGARD144A ^④	Tool-less Hail Guard	YS*150F
BAYGARD145A ^④	Tool-less Hail Guard	YH*150F, YS*180F-300F
BAYGARD150A ^④	Tool-less Hail Guard	YH*210F-300F, YH*180F
BAYHSDR005B ^⑤	High Static Drive	YS*150, 180F, YH*150F, 180F
BAYHSDR010A	High Static Drive	YH*210F, 240F, YS*300F
BAYHSDR011A	High Static Drive	YS*210F, 240F, YH*300F

- ① Kit contains all necessary parts to achieve desired level of Enthalpy Control.
 ② Reference Enthalpy senses outside temperature/humidity.
 ③ Comparative Enthalpy senses outside temperature/humidity and inside return/mixed air temperature/humidity.
 ④ High static drive and oversized motors are mutually exclusive, Do Not Combine.
 ⑤ See Accessory IOM for operational characteristics.
 ⑥ Clarksville Manufacturing has a no-return policy for this roof curb.
 ⑦ BAYABRD002 is required when ordering BAYDFPS005A or 006A, BAYTUBE008A or 009A and BAYLOAM023A or BAYVNOR002B.
 ⑧ Field or factory installed option.
 * Either horizontal or downflow models

**For additional Controls Information:
 See ReliaTel™ and Micro Control features on LPC-12 and LPC-13.**

BUILT TO A HIGHER STANDARD*



Packaged Gas/Electric with ReliaTel™ Controls 12½-25 Tons Accessories

Table LPG-16-A — Field Installed Accessories

Model Number	Description	Used With
BAYHSMT039B ^{①④}	5HP Oversized Motor Kit (208-230/460V)	YS*150F
BAYHSMT040B ^④	5HP Oversized Motor Kit (575V)	YS*150F
BAYHSMT055B ^{①④}	5HP Oversized Motor Kit (208-230/460V)	YS*180F
BAYHSMT042A ^{②④}	7-1/2HP Oversized Motor Kit (575V)	YS*210F, 240F, YH*210F, 240F
BAYHSMT072A ^{②④}	7-1/2HP Oversized Motor Kit (575V)	YS*180F, YH*180F
BAYHSMT098A ^{②④}	7-1/2HP Oversized Motor Kit (230V)	YH*210F, YH*240F
BAYHSMT099A ^{②④}	7-1/2HP Oversized Motor Kit (460V)	YH*210F, YH*240F
BAYLOAM023A ^③	Evaporator Defrost Control	YS*150F, YH*150F, YS*180F, YS*210F, 240F, 300F
BAYLOAM031A	Evaporator Defrost Control	YH*210F, 240F, 300F, 180F
BAYLPKT018A	LP Conversion Kit	YC*150F-YC*301F
BAYLSDR004A ^②	Low Static Drive	YS*150F, 180F, 210F, YH*210F, YS*240F, YH*241F
BAYLSDR002A ^②	Low Static Drive	YH*150F, 180F, YS*300F
BAYPWRX029A	Power Exhaust for all Voyagers 12½-25 Ton 230V units	Downflow Only
BAYPWRX030A	Power Exhaust for all Voyagers 12½-25 Ton 460V units	Downflow Only
BAYPWRX031A	Power Exhaust for all Voyagers 12½-25 Ton 575V units	Downflow Only
BAYSERV001A	Selective Resistance Service Tester	YC*150F-YC*301F
BAYSTAT023	Remote Potentiometer	YC*150F-YC*301F
BAYTUBE008A ^{③④}	Discharge Air Sensing Kit	YCD150F-YCD301F
BAYTUBE009A ^{③④}	Discharge Air Sensing Kit	YCH150F-YCH301F
BAYQACB044A	Adapter Curb	BAYCURB026A/B to BAYCURB027A/B
BAYVNOR002B ^③	Ventilation Override Kit	YC*150F-YC*301F

- ① High static drive and oversized motors are mutually exclusive, Do Not Combine.
 - ② Low static drive and oversized motors are mutually exclusive, Do Not Combine.
 - ③ BAYABRD002 is required when ordering BAYDFPS005A or 006A, BAYTUBE008A or 009A and BAYLOAM023A, BAYLOAM031A or BAYVNOR002B.
 - ④ Field or factory installed option.
- * Either horizontal or downflow models

Packaged Gas/Electric with ReliaTel™ Controls 12½-25 Tons, R-22, R-410A Zone Sensors / Thermostats

Table LPG-16-B — Zone Sensors — ReliaTel™

Model Number	Description	Used With
ASYSTAT106A	Single Setpoint Manual Changeover	YC*150-301
ASYSTAT108A	Dual Setpoint Manual or Automatic Changeover	YC*150-301
ASYSTAT111A	Remote Room Sensor	ASYSTAT777A
ASYSTAT777A	Programmable Night Setback	YC*150-301
ASYSTAT710A	Wall Mounted Humidity Sensor	YHD150, 180, 240F (with Reheat)
ASYSTAT711A	Duct Mounted Humidity Sensor	YHD150, 180, 240F (with Reheat)
BAYMTPL110A	Retrofit Wall Cover Plate Kit 7.25" x 6.0"	ASYSTAT777A
BAYSENS924A	Title 24 Zone Sensor ^①	All

① Must be used with ReliaTel™ Control and BCI Communications Interface.

**For additional Controls Information:
See ReliaTel™ and Micro Control features on LPC-12 and LPC-13.**

For complete equipment / combination selections, installation instructions and warranty information, please refer to Product Data/Ratings and/or Installers Guides and Limited Warranty Handbooks.

Packaged Unit Accessories 12½-25 Tons

12 1/2 – 25 Ton Packaged Gas/Electric,
 Electric/Electric and Heat Pump

Dedicated Airflow Design

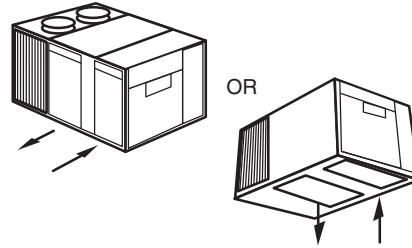

Typical Downflow Application

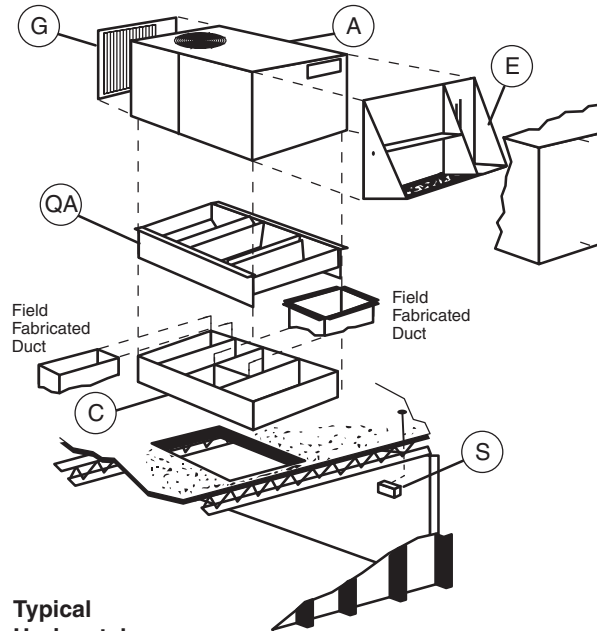

Typical Horizontal Application

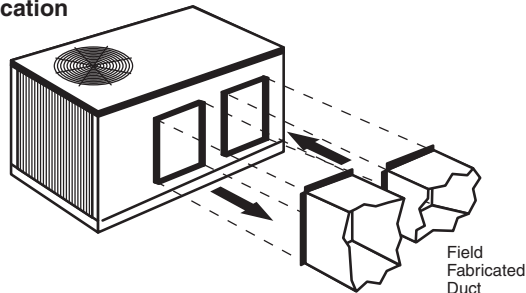

Typical Economizer Application

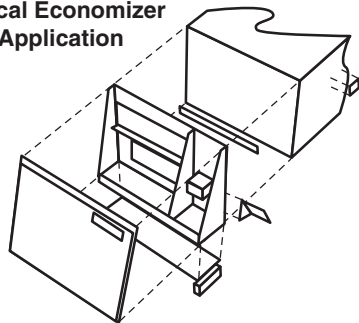

Factory Supplied Accessories

- (A) Unit
 Y*D/H, T*D/H, WSD/H
- (G) Coil Guard (BAYGARD)
- (E) Economizer (Downflow and Horizontal) (BAYECON)
- (D) Fresh Air Damper (BAYDMPR)
 Manual (0-25%) Motorized (0-50%)
- (S) Sensor/Thermostat
- (C) Curb (BAYCURB)
- (QA) Quick Adapt Curb...Field Supplied (BAYCURB)
- (PE) Power Exhaust (BAYPWRX)

Power Exhaust Accessory

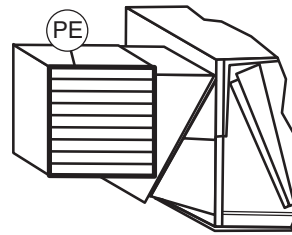

BUILT TO A HIGHER STANDARD™

American Standard
HEATING & AIR CONDITIONING

Foundation™ Packaged Gas/Electric 3-5 Tons, R-410A

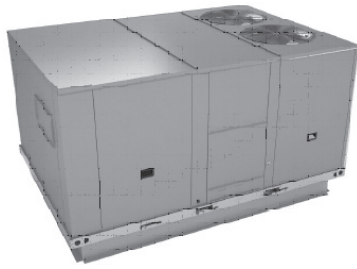

- Scroll compressors on all units
- Operating Charge of R-410A
- Low ambient operation of 40 F as standard
- Color coded and numbered wiring
- Single side service access
- Provisions for through the base connections
- Phase monitor on all units
- Convertible airflow on all units
- Non-corrosive drain pan
- Separate high and low voltage areas in control box
- **5-year limited compressor and heat exchanger warranty**

Table LPG-18-A — Foundation™ - R-410A - Electromechanical Controls

Tons	Unit Model No	Power Supply Volts/Phase/Hz	Performance SEER	Cooling Capacity (Btuh)	Heating Output Capacity (Btuh)	Dimensions (in.) H x W x L	Shipping Weight (lbs.)	MCA**	Max Fuse Size or Max Circuit Breaker**	Downflow Roofcurb ^①
GBC - Three Phase Low Heat										
3	GBC036A3ELB0000	208-230/3/60	14.0	36,000	57,600	42 ⁵ / ₈ x 48 x 76 ⁷ / ₈	574	19.5	25	BAYCURB320A
4	GBC048A3ELB0000	208-230/3/60	14.0	48,000	57,600	42 ⁵ / ₈ x 48 x 76 ⁷ / ₈	616	23.6	35	BAYCURB320A
5	GBC060A3ELB0000	208-230/3/60	14.0	57,500	57,600	42 ⁵ / ₈ x 48 x 76 ⁷ / ₈	636	26.4	40	BAYCURB320A
<hr/>										
3	GBC036A4ELB0000	460/3/60	14.0	36,000	57,600	42 ⁵ / ₈ x 48 x 76 ⁷ / ₈	574	10.5	15	BAYCURB320A
4	GBC048A4ELB0000	460/3/60	14.0	48,000	57,600	42 ⁵ / ₈ x 48 x 76 ⁷ / ₈	616	11	15	BAYCURB320A
5	GBC060A4ELB0000	460/3/60	14.0	57,500	57,600	42 ⁵ / ₈ x 48 x 76 ⁷ / ₈	636	12.9	20	BAYCURB320A
<hr/>										
3	GBC036AWELB0000	575/3/60	14.0	36,000	57,600	42 ⁵ / ₈ x 48 x 76 ⁷ / ₈	574	6.8	15	BAYCURB320A
4	GBC048AWELB0000	575/3/60	14.0	48,000	57,600	42 ⁵ / ₈ x 48 x 76 ⁷ / ₈	616	8.1	15	BAYCURB320A
5	GBC060AWELB0000	575/3/60	14.0	57,500	57,600	42 ⁵ / ₈ x 48 x 76 ⁷ / ₈	636	9.2	15	BAYCURB320A
<hr/>										
GBC - Three Phase Medium Heat										
3	GBC036A3EMB0000	208-230/3/60	14.0	36,000	80,000	42 ⁵ / ₈ x 48 x 76 ⁷ / ₈	574	19.5	25	BAYCURB320A
4	GBC048A3EMB0000	208-230/3/60	14.0	48,000	92,000	42 ⁵ / ₈ x 48 x 76 ⁷ / ₈	616	23.6	35	BAYCURB320A
5	GBC060A3EMB0000	208-230/3/60	14.0	57,500	92,000	42 ⁵ / ₈ x 48 x 76 ⁷ / ₈	636	26.4	40	BAYCURB320A
<hr/>										
3	GBC036A4EMB0000	460/3/60	14.0	36,000	80,000	42 ⁵ / ₈ x 48 x 76 ⁷ / ₈	574	10.5	15	BAYCURB320A
4	GBC048A4EMB0000	460/3/60	14.0	48,000	92,000	42 ⁵ / ₈ x 48 x 76 ⁷ / ₈	616	11	15	BAYCURB320A
5	GBC060A4EMB0000	460/3/60	14.0	57,500	92,000	42 ⁵ / ₈ x 48 x 76 ⁷ / ₈	636	12.9	20	BAYCURB320A
<hr/>										
3	GBC036AWEMB0000	575/3/60	14.0	36,000	80,000	42 ⁵ / ₈ x 48 x 76 ⁷ / ₈	574	6.8	15	BAYCURB320A
4	GBC048AWEMB0000	575/3/60	14.0	48,000	92,000	42 ⁵ / ₈ x 48 x 76 ⁷ / ₈	616	8.1	15	BAYCURB320A
5	GBC060AWEMB0000	575/3/60	14.0	57,500	92,000	42 ⁵ / ₈ x 48 x 76 ⁷ / ₈	636	9.2	15	BAYCURB320A

① For Downflow units only.

** Information subject to change. Please confirm with current Product Data/Service Facts for current factory production.

Foundation™ Packaged Gas/Electric 3-5 Ton Accessories

Table LPG-19-A — Foundation™ - Field Installed Accessories

Model Number	Description	Used With
BAYCURB320A	Roof curb	All
BAYGARD320A	Tool-less Hail Guard	All
BAYHAKT320A	High Altitude Kit	All
BAYLPKT320A	LP Kit	GBC Only
BAYTBGF320A	Through the base - Gas	GBC Only
BAYTBUE320A	Through the base - Elec.	All
BAYDSCF320A	Unit Mounted Disconnect- cooling only, 100 Amp	GBC, EBC No Elec Heat
BAYCO2K300A	Wall Mounted CO2 Sensor	All
BAYCO2K301A	Duct Mounted CO2 Sensor	All
BAYCOSW320A	Condensate Overflow	All
BAYCCHT010B	CCH – 208-230V (40 W) 6.5"	E/GBC(048 & 060)A3
BAYCCHT011B	CCH - 460V/572V (40W) 6.5"	E/GBC(048 & 060A)(4 & W)
BAYCCHT103A	CCH – 208-230V (40 W) 5.5"	E/GBC036A3
BAYCCHT405A	CCH - 460V/572V (40W) 5.5"	E/GBC036A(4 & W)
BAYLOAM330A	Frostat	All
BAYLOAM340A	Low Ambient Kit	All
BAYASCT001	Compressor Short Cycle Timer	All
BAYHSMT320A	2 HP Oversize motor Kit (208-230/460V)	All
BAYHSMT321A	2 HP Oversize motor Kit (380V)	All
BAYHSMT322A	2 HP Oversize motor Kit (575V)	All
BAYDMPR321A	Damper, Manual 3-5T	All
BAYDMPR320A	Damper, Motorized 3-5T	All
BAYBARO320A	Barometric Relief Damper, 3-5T	All
BAYECON320A	Economizer, Dry Bulb, Downflow 3-5T	All
BAYENTH320A	Reference Enthalpy Economizer, 3-5T	All
BAYENTH321A	Comparative Enthalpy Economizer, 3-5T	All
BAYECON353A ^①	Low Leak Economizer, Dry Bulb, Downflow W/FDD, 3-5T	All
BAYECON354A ^①	Low Leak Economizer, Dry Bulb, Horizontal W/FDD, 3-5T	All
BAYENTH323A ^①	Comparative Enthalpy, LLE W/FDD, 3-5T	All
BAYENTH322A ^①	Reference Enthalpy, LLE W/FDD, 3-5T	All
BAYBARO321A ^①	Barometric Relief Damper, LLE W/FDD, 3-5T	All
BAYPWRX320A ^②	Power Exhasust, 3-5T DF, 230V	All
BAYPWRX321A ^②	Power Exhaust, 3-5T DF, 460V	All
BAYPWRX322A ^②	Power Exhasut, 3-5T DF, 575V	All

^① FDD = Fault Detection & Diagnosis

^② Please check availability

BUILT TO A HIGHER STANDARD™

American Standard
HEATING & AIR CONDITIONING

Foundation™ Packaged Gas/Electric 15-25 Tons, R-410A

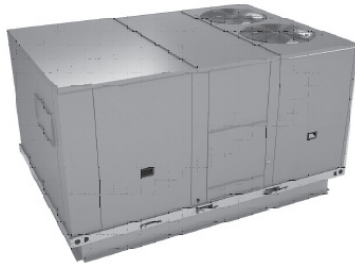

- Scroll compressors on all units
- Operating charge of R-410A
- Low ambient operation to 40°F as standard
- Color coded and numbered wiring
- Single side service access
- Molded handles on service access doors
- Liquid Line Refrigerant Drier
- Provisions for through the base connections
- Phase monitor on all units
- Convertible airflow with field installed kit on most models
- Two inch throwaway filters as standard
- Non-corrosive & removable drain pan
- Separated high and low voltage compartments
- **5-year limited compressor and heat exchanger warranty (15-25 tons)**

Table LPG-20-A — Foundation™ — R-410A — Electromechanical Controls

Unit Tons	Model No.	Power Supply Volts/Phase/Hz	Performance IEER	Cooling Capacity (Btuh)	Heating Output Capacity (Btuh)	Dimensions (in.) H x W x L	Shipping Weight (lbs.)	MCA	Max Fuse Size or Max Circuit Breaker ^①	Downflow Roofcurb
GBC - Three Phase Low Heat										
15	GBC180A3ELA0000	208-230/3/60	12.4	184000	192000	58 ⁵ / ₈ x 86 ⁵ / ₁₆ x 123 ¹ / ₈	2310	75	100	BAYCURB027B
17 ¹ / ₂	GBC210A3ELA0000	208-230/3/60	12.4	216000	192000	58 ⁵ / ₈ x 86 ⁵ / ₁₆ x 123 ¹ / ₈	2319	86	110	BAYCURB027B
20	GBC240A3ELA0000	208-230/3/60	11.6	256000	192000	58 ⁵ / ₈ x 86 ⁵ / ₁₆ x 123 ¹ / ₈	2344	97	125	BAYCURB027B
25	GBC300A3ELA0000	208-230/3/60	11.4	284000	192000	58 ⁵ / ₈ x 86 ⁵ / ₁₆ x 123 ¹ / ₈	2370	126	175	BAYCURB027B
GBC - Three Phase Medium Heat										
15	GBC180A4ELA0000	460/3/60	12.4	184000	192000	58 ⁵ / ₈ x 86 ⁵ / ₁₆ x 123 ¹ / ₈	2310	35	45	BAYCURB027B
17 ¹ / ₂	GBC210A4ELA0000	460/3/60	12.4	216000	192000	58 ⁵ / ₈ x 86 ⁵ / ₁₆ x 123 ¹ / ₈	2319	42	50	BAYCURB027B
20	GBC240A4ELA0000	460/3/60	11.6	256000	192000	58 ⁵ / ₈ x 86 ⁵ / ₁₆ x 123 ¹ / ₈	2344	46	60	BAYCURB027B
25	GBC300A4ELA0000	460/3/60	11.4	284000	192000	58 ⁵ / ₈ x 86 ⁵ / ₁₆ x 123 ¹ / ₈	2370	53	70	BAYCURB027B
GBC - Three Phase High Heat										
15	GBC180AWELA0000	575/3/60	12.4	184000	192000	58 ⁵ / ₈ x 86 ⁵ / ₁₆ x 123 ¹ / ₈	2310	28	35	BAYCURB027B
17 ¹ / ₂	GBC210AWELA0000	575/3/60	12.4	216000	192000	58 ⁵ / ₈ x 86 ⁵ / ₁₆ x 123 ¹ / ₈	2319	34	45	BAYCURB027B
20	GBC240AWELA0000	575/3/60	11.6	256000	192000	58 ⁵ / ₈ x 86 ⁵ / ₁₆ x 123 ¹ / ₈	2344	38	50	BAYCURB027B
25	GBC300AWELA0000	575/3/60	11.4	284000	192000	58 ⁵ / ₈ x 86 ⁵ / ₁₆ x 123 ¹ / ₈	2370	44	50	BAYCURB027B
GBC - Three Phase Medium Heat										
15	GBC180A3EMA0000	208-230/3/60	12.4	184000	256000	58 ⁵ / ₈ x 86 ⁵ / ₁₆ x 123 ¹ / ₈	2310	75	100	BAYCURB027B
17 ¹ / ₂	GBC210A3EMA0000	208-230/3/60	12.4	216000	256000	58 ⁵ / ₈ x 86 ⁵ / ₁₆ x 123 ¹ / ₈	2319	86	110	BAYCURB027B
20	GBC240A3EMA0000	208-230/3/60	11.6	256000	256000	58 ⁵ / ₈ x 86 ⁵ / ₁₆ x 123 ¹ / ₈	2344	97	125	BAYCURB027B
25	GBC300A3EMA0000	208-230/3/60	11.4	284000	256000	58 ⁵ / ₈ x 86 ⁵ / ₁₆ x 123 ¹ / ₈	2370	126	175	BAYCURB027B
GBC - Three Phase High Heat										
15	GBC180A4EMA0000	460/3/60	12.4	184000	256000	58 ⁵ / ₈ x 86 ⁵ / ₁₆ x 123 ¹ / ₈	2310	35	45	BAYCURB027B
17 ¹ / ₂	GBC210A4EMA0000	460/3/60	12.4	216000	256000	58 ⁵ / ₈ x 86 ⁵ / ₁₆ x 123 ¹ / ₈	2319	42	50	BAYCURB027B
20	GBC240A4EMA0000	460/3/60	11.6	256000	256000	58 ⁵ / ₈ x 86 ⁵ / ₁₆ x 123 ¹ / ₈	2344	46	60	BAYCURB027B
25	GBC300A4EMA0000	460/3/60	11.4	284000	256000	58 ⁵ / ₈ x 86 ⁵ / ₁₆ x 123 ¹ / ₈	2370	53	70	BAYCURB027B
GBC - Three Phase High Heat										
15	GBC180AWEMA0000	575/3/60	12.4	184000	256000	58 ⁵ / ₈ x 86 ⁵ / ₁₆ x 123 ¹ / ₈	2310	28	35	BAYCURB027B
17 ¹ / ₂	GBC210AWEMA0000	575/3/60	12.4	216000	256000	58 ⁵ / ₈ x 86 ⁵ / ₁₆ x 123 ¹ / ₈	2319	34	45	BAYCURB027B
20	GBC240AWEMA0000	575/3/60	11.6	256000	256000	58 ⁵ / ₈ x 86 ⁵ / ₁₆ x 123 ¹ / ₈	2344	38	50	BAYCURB027B
25	GBC300AWEMA0000	575/3/60	11.4	284000	256000	58 ⁵ / ₈ x 86 ⁵ / ₁₆ x 123 ¹ / ₈	2370	44	50	BAYCURB027B
GBC - Three Phase High Heat										
15	GBC180A3EHA0000	208-230/3/60	12.4	184000	280000	58 ⁵ / ₈ x 86 ⁵ / ₁₆ x 123 ¹ / ₈	2310	75	100	BAYCURB027B
17 ¹ / ₂	GBC210A3EHA0000	208-230/3/60	12.4	216000	320000	58 ⁵ / ₈ x 86 ⁵ / ₁₆ x 123 ¹ / ₈	2319	86	110	BAYCURB027B
20	GBC240A3EHA0000	208-230/3/60	11.6	256000	320000	58 ⁵ / ₈ x 86 ⁵ / ₁₆ x 123 ¹ / ₈	2344	97	125	BAYCURB027B
25	GBC300A3EHA0000	208-230/3/60	11.4	284000	320000	58 ⁵ / ₈ x 86 ⁵ / ₁₆ x 123 ¹ / ₈	2370	126	175	BAYCURB027B
GBC - Three Phase High Heat										
15	GBC180A4EHA0000	460/3/60	12.4	184000	280000	58 ⁵ / ₈ x 86 ⁵ / ₁₆ x 123 ¹ / ₈	2310	35	45	BAYCURB027B
17 ¹ / ₂	GBC210A4EHA0000	460/3/60	12.4	216000	320000	58 ⁵ / ₈ x 86 ⁵ / ₁₆ x 123 ¹ / ₈	2319	42	50	BAYCURB027B
20	GBC240A4EHA0000	460/3/60	11.6	256000	320000	58 ⁵ / ₈ x 86 ⁵ / ₁₆ x 123 ¹ / ₈	2344	46	60	BAYCURB027B
25	GBC300A4EHA0000	460/3/60	11.4	284000	320000	58 ⁵ / ₈ x 86 ⁵ / ₁₆ x 123 ¹ / ₈	2370	53	70	BAYCURB027B
GBC - Three Phase High Heat										
15	GBC180AWEHA0000	575/3/60	12.4	184000	280000	58 ⁵ / ₈ x 86 ⁵ / ₁₆ x 123 ¹ / ₈	2310	28	35	BAYCURB027B
17 ¹ / ₂	GBC210AWEHA0000	575/3/60	12.4	216000	320000	58 ⁵ / ₈ x 86 ⁵ / ₁₆ x 123 ¹ / ₈	2319	34	45	BAYCURB027B
20	GBC240AWEHA0000	575/3/60	11.6	256000	320000	58 ⁵ / ₈ x 86 ⁵ / ₁₆ x 123 ¹ / ₈	2344	38	50	BAYCURB027B
25	GBC300AWEHA0000	575/3/60	11.4	284000	320000	58 ⁵ / ₈ x 86 ⁵ / ₁₆ x 123 ¹ / ₈	2370	44	50	BAYCURB027B

① HACR Circuit Breaker Type Per NEC.

Information subject to change. Please confirm with current Product Data for current factory production.

For complete equipment / combination selections, installation instructions and warranty information, please refer to Product Data/Ratings and/or Installers Guides and Limited Warranty Handbooks.

Foundation™ Packaged Gas/Electric 15-25 Tons, R-410A, 2-Speed Indoor Fans

Table LPG-21-A — Foundation™ - R-410A - Electromechanical Controls - 2-Speed Indoor Fans

Tons	Unit Model No	Power Supply Volts/Phase/Hz	Performance IEER	Cooling Capacity (Btuh)	Heating Output Capacity (Btuh)	Dimensions (in.) H x W x L	Shipping Weight (lbs.)	MCA**	Max Fuse Size or Max Circuit Breaker**	Downflow Roofcurb ^①
GBC - Three Phase Low Heat										
15	GBC180A3ELA1DQY	208-230/3/60	13.2	184000	192000	58 ⁵ / ₈ x 86 ⁵ / ₁₆ x 123 ³ / ₈	2310	75	100	BAYCURB027B
17½	GBC210A3ELA1DQY	208-230/3/60	13.2	216000	192000	58 ⁵ / ₈ x 86 ⁵ / ₁₆ x 123 ³ / ₈	2319	86	110	BAYCURB027B
20	GBC240A3ELA1DQY	208-230/3/60	12.4	256000	192000	58 ⁵ / ₈ x 86 ⁵ / ₁₆ x 123 ³ / ₈	2344	97	125	BAYCURB027B
25	GBC300A3ELA1DQY	208-230/3/60	12.4	284000	192000	58 ⁵ / ₈ x 86 ⁵ / ₁₆ x 123 ³ / ₈	2370	126	175	BAYCURB027B
15	GBC180A4ELA1DQY	460/3/60	13.2	184000	192000	58 ⁵ / ₈ x 86 ⁵ / ₁₆ x 123 ³ / ₈	2310	35	45	BAYCURB027B
17½	GBC210A4ELA1DQY	460/3/60	13.2	216000	192000	58 ⁵ / ₈ x 86 ⁵ / ₁₆ x 123 ³ / ₈	2319	42	50	BAYCURB027B
20	GBC240A4ELA1DQY	460/3/60	12.4	256000	192000	58 ⁵ / ₈ x 86 ⁵ / ₁₆ x 123 ³ / ₈	2344	46	60	BAYCURB027B
25	GBC300A4ELA1DQY	460/3/60	12.4	284000	192000	58 ⁵ / ₈ x 86 ⁵ / ₁₆ x 123 ³ / ₈	2370	53	70	BAYCURB027B
15	GBC180AWELA1DQY	575/3/60	13.2	184000	192000	58 ⁵ / ₈ x 86 ⁵ / ₁₆ x 123 ³ / ₈	2310	28	35	BAYCURB027B
17½	GBC210AWELA1DQY	575/3/60	13.2	216000	192000	58 ⁵ / ₈ x 86 ⁵ / ₁₆ x 123 ³ / ₈	2319	34	45	BAYCURB027B
20	GBC240AWELA1DQY	575/3/60	12.4	256000	192000	58 ⁵ / ₈ x 86 ⁵ / ₁₆ x 123 ³ / ₈	2344	38	50	BAYCURB027B
25	GBC300AWELA1DQY	575/3/60	12.4	284000	192000	58 ⁵ / ₈ x 86 ⁵ / ₁₆ x 123 ³ / ₈	2370	44	50	BAYCURB027B
GBC - Three Phase Medium Heat										
15	GBC180A3EMA1DQY	208-230/3/60	13.2	184000	256000	58 ⁵ / ₈ x 86 ⁵ / ₁₆ x 123 ³ / ₈	2310	75	100	BAYCURB027B
17½	GBC210A3EMA1DQY	208-230/3/60	13.2	216000	256000	58 ⁵ / ₈ x 86 ⁵ / ₁₆ x 123 ³ / ₈	2319	86	110	BAYCURB027B
20	GBC240A3EMA1DQY	208-230/3/60	12.4	256000	256000	58 ⁵ / ₈ x 86 ⁵ / ₁₆ x 123 ³ / ₈	2344	97	125	BAYCURB027B
25	GBC300A3EMA1DQY	208-230/3/60	12.4	284000	256000	58 ⁵ / ₈ x 86 ⁵ / ₁₆ x 123 ³ / ₈	2370	126	175	BAYCURB027B
15	GBC180A4EMA1DQY	460/3/60	13.2	184000	256000	58 ⁵ / ₈ x 86 ⁵ / ₁₆ x 123 ³ / ₈	2310	35	45	BAYCURB027B
17½	GBC210A4EMA1DQY	460/3/60	13.2	216000	256000	58 ⁵ / ₈ x 86 ⁵ / ₁₆ x 123 ³ / ₈	2319	42	50	BAYCURB027B
20	GBC240A4EMA1DQY	460/3/60	12.4	256000	256000	58 ⁵ / ₈ x 86 ⁵ / ₁₆ x 123 ³ / ₈	2344	46	60	BAYCURB027B
25	GBC300A4EMA1DQY	460/3/60	12.4	284000	256000	58 ⁵ / ₈ x 86 ⁵ / ₁₆ x 123 ³ / ₈	2370	53	70	BAYCURB027B
15	GBC180AWEMA1DQY	575/3/60	13.2	184000	256000	58 ⁵ / ₈ x 86 ⁵ / ₁₆ x 123 ³ / ₈	2310	28	35	BAYCURB027B
17½	GBC210AWEMA1DQY	575/3/60	13.2	216000	256000	58 ⁵ / ₈ x 86 ⁵ / ₁₆ x 123 ³ / ₈	2319	34	45	BAYCURB027B
20	GBC240AWEMA1DQY	575/3/60	12.4	256000	256000	58 ⁵ / ₈ x 86 ⁵ / ₁₆ x 123 ³ / ₈	2344	38	50	BAYCURB027B
25	GBC300AWEMA1DQY	575/3/60	12.4	284000	256000	58 ⁵ / ₈ x 86 ⁵ / ₁₆ x 123 ³ / ₈	2370	44	50	BAYCURB027B
GBC - Three Phase High Heat^①										
15	GBC180A3EHA1DQY	208-230/3/60	13.2	184000	280000	58 ⁵ / ₈ x 86 ⁵ / ₁₆ x 123 ³ / ₈	2310	75	100	BAYCURB027B
17½	GBC210A3EHA1DQY	208-230/3/60	13.2	216000	320000	58 ⁵ / ₈ x 86 ⁵ / ₁₆ x 123 ³ / ₈	2319	86	110	BAYCURB027B
20	GBC240A3EHA1DQY	208-230/3/60	12.4	256000	320000	58 ⁵ / ₈ x 86 ⁵ / ₁₆ x 123 ³ / ₈	2344	97	125	BAYCURB027B
25	GBC300A3EHA1DQY	208-230/3/60	12.4	284000	320000	58 ⁵ / ₈ x 86 ⁵ / ₁₆ x 123 ³ / ₈	2370	126	175	BAYCURB027B
15	GBC180A4EHA1DQY	460/3/60	13.2	184000	280000	58 ⁵ / ₈ x 86 ⁵ / ₁₆ x 123 ³ / ₈	2310	35	45	BAYCURB027B
17½	GBC210A4EHA1DQY	460/3/60	13.2	216000	320000	58 ⁵ / ₈ x 86 ⁵ / ₁₆ x 123 ³ / ₈	2319	42	50	BAYCURB027B
20	GBC240A4EHA1DQY	460/3/60	12.4	256000	320000	58 ⁵ / ₈ x 86 ⁵ / ₁₆ x 123 ³ / ₈	2344	46	60	BAYCURB027B
25	GBC300A4EHA1DQY	460/3/60	12.4	284000	320000	58 ⁵ / ₈ x 86 ⁵ / ₁₆ x 123 ³ / ₈	2370	53	70	BAYCURB027B
15	GBC180AWEHA1DQY	575/3/60	13.2	184000	280000	58 ⁵ / ₈ x 86 ⁵ / ₁₆ x 123 ³ / ₈	2310	28	35	BAYCURB027B
17½	GBC210AWEHA1DQY	575/3/60	13.2	216000	320000	58 ⁵ / ₈ x 86 ⁵ / ₁₆ x 123 ³ / ₈	2319	34	45	BAYCURB027B
20	GBC240AWEHA1DQY	575/3/60	12.4	256000	320000	58 ⁵ / ₈ x 86 ⁵ / ₁₆ x 123 ³ / ₈	2344	38	50	BAYCURB027B
25	GBC300AWEHA1DQY	575/3/60	12.4	284000	320000	58 ⁵ / ₈ x 86 ⁵ / ₁₆ x 123 ³ / ₈	2370	44	50	BAYCURB027B

① HACR Circuit Breaker Type Per NEC.

** Information subject to change. Please confirm with current Product Data/Service Facts for current factory production.

BUILT TO A HIGHER STANDARD[®]

American Standard[®]
HEATING & AIR CONDITIONING

Foundation[™] Packaged Gas/Electric 15-25 Tons Accessories

Table LPG-22-A — Foundation[™] — R-410A — Field Installed Accessories

Model Number	Description	Used With
BAYTBUE300A.....	Through the Base Electrical Connections.....	All Foundation 15-25 Ton Units
BAYDSCF300A.....	Unit Mounted Disconnect, 100 Amp.....	GA*180A4* - GA*300A4*, GA*180AW* - GA*300AW*
BAYDSCF301A.....	Unit Mounted Disconnect, 150 Amp.....	GA*180A3* - GA*300A3*
BAYTBGF300A.....	Through the Base Gas Connection, 400 MBH.....	GA*180A* - GA*300A*
BAYLPKT300A.....	Propane Conversion Kit.....	GA*180A* - GA*300A*
BAYHAKT300A.....	High Altitude Conversion Kit.....	GA*180A* - GA*300A*
BAYDMPR301A.....	Damper, Manual.....	GA*180A* - GA*300A*
BAYDMPR300A.....	Damper, Motorized.....	GA*180A* - GA*300A*
BAYECON300A.....	Economizer, Dry Bulb, Downflow.....	GA*180A* - GA*300A*
BAYECON301A.....	Economizer, Dry Bulb, Horizontal.....	GA*180A* - GA*300A*
BAYECON350A ^③	Low Leak Economizer w/FDD, Dry Bulb, Downflow.....	GA*180A* - GA*300A*
BAYECON351A.....	Low Leak Economizer w/FDD, Dry Bulb, Horizontal.....	GA*180A* - GA*300A*
BAYHZCN300A.....	Horizontal Economizer Conversion Kit.....	GA*180A* - GA*300A*
BAYBARO300A.....	Barometric Relief Damper, 15-25T.....	GA*180A* - GA*300A*
BAYENTH300A.....	Reference Enthalpy Economizer Kit.....	GA*180A* - GA*300A*
BAYENTH301A.....	Comparative Enthalpy Economizer Kit.....	GA*180A* - GA*300A*
BAYENTH302A ^③	Reference Enthalpy Economizer Kit.....	GA*180A* - GA*300A* w/Low Leak Economizer & FDD
BAYENTH303A ^③	Comparative Enthalpy Economizer Kit.....	GA*180A* - GA*300A* w/Low Leak Economizer & FDD
BAYCURB027B.....	Roof Curb.....	GA*180A* - GA*300A*
BAYHZRT001A.....	Horizontal Duct Conversion Kit.....	GA*180A* - GA*300A*
BAYCARR001A.....	Carrier Replacement Conversion Kit.....	GA*180A* - GA*300A*
BAYGARD300A.....	Condenser Hail Guard.....	GA*180A* - GA*300A*
BAYCCHT300A.....	Crankcase Heater, 70W, 230V.....	GA*180A3 - GA*300A3
BAYCCHT301A.....	Crankcase Heater, 70W, 460V.....	GA*180A4 - GA*300A4
BAYCCHT302A.....	Crankcase Heater, 70W, 575V.....	GA*180AW - GA*300AW
BAYASCT001.....	Compressor Short Cycle Timer.....	GA*180A* - GA*300A*
BAYLOAM300A.....	Low Ambient Control.....	GA*180A* - GA*300A*
BAYLOAM310A.....	Evaporator Defrost Control.....	GA*180A* - GA*300A*
BAYPWRX300A ^①	Power Exhaust, 15-25T, DF, 230V.....	GA*180A3 - GA*300A3
BAYPWRX301A ^①	Power Exhaust, 15-25T, DF, 460V.....	GA*180A4 - GA*300A4
BAYPWRX302A ^①	Power Exhaust, 15-25T, DF, 575V.....	GA*180AW - GA*300AW
BAYHSMT300A.....	High Static Motor & Drv, 5HP 230/460V.....	GA*180A3, GA*180A4
BAYHSMT301A.....	High Static Motor & Drv, 5HP 575V.....	GA*180AW
BAYHSMT302A.....	High Static Motor & Drv, 7.5HP 230/460V.....	GA*210A3, GA*240A3
BAYHSMT303A.....	High Static Motor & Drv, 7.5HP 460V.....	GA*210A4, GA*240A4
BAYHSMT304A.....	High Static Motor & Drv, 7.5HP 575V.....	GA*210AW, GA*240AW
BAYSHGR003A ^②	Shaft Grounding Ring, 0.875" Shaft.....	5HP VFD Motors
BAYSHGR002A ^②	Shaft Grounding Ring, 1.125" Shaft.....	7.5HP VFD Motors
BAYLSDR300A.....	Low Static Drive Option.....	GA*180A* - GA*300A*
BAYHSDR300A.....	High Static Drive Option.....	GA*180A* - GA*300A*
BAYCO2K300A.....	Wall Mounted CO2 Sensor.....	GA*180A* - GA*300A* with economizer
BAYCO2K301A.....	Duct Mounted CO2 Sensor.....	GA*180A* - GA*300A* with economizer
BAYCOSW300A.....	Drain Pan Overflow Switch.....	GA*180A* - GA*300A*
BAYSTAT300A.....	BACNet Enabled Thermostat.....	GA*180A* - GA*300A*
BAYPALT001A.....	Reuseable Pallet for Condenser End Unit Lifting.....	All Foundation 15-25 Ton Units

① Please check availability.

② See HVAC Knowledge Center for a list of compatible Carrier units.

③ FDD = Fault Detection & Diagnostics.

Information subject to change. Please confirm with current Product Data for current factory production.

3-25 Ton Packaged Units Roof Curb Compatibility Information

Table LAC/IN-1-A — 3-10 Ton Convertible Packaged Units Roof Curb Compatibility

BAYCURB042			BAYCURB043			BAYCURB044		
T/YSC	T/YHC	WSC	T/YSC	T/YHC	WSC	T/YSC	T/YHC	WSC
036A	033A	036A	072A	072A	072A		092E	120E
048A	036A	048A	090A	092A	090A		102E	
060A	043A	060A	092A	102A	120A		120E	
036E	048A	036E	102A	120A	060E			
048E	060A	048E	120A	048E	072E			
060E	063A		072E	060E	090E			
	036E		090E	072E				
			092E	092E*				
			102E	102E*				
			120E	120E*				

* = This curb is used for retrofit or replacement applications only for these units.

Table LAC/IN-1-B — 12½-25 Ton Packaged Units Roof Curb Compatibility Reference for Packaged Units Manufactured Prior to 2002

BAYCURB021A/B			BAYCURB022A/B			BAYCURB025A/B			BAYCURB026A/B			BAYCURB027A/B		
YCD	TCD	WCD	YCD	TCD	WCD	YCD	TCD	WCD	YCD	TCD	WCD	YCD	TCD	WCD
036A	036C	036C	061C	061C	075A	102A	102A	120A	121C	121C	150A	181B	181B	240A
036C	037C	048C	074C	074C	075C	102B	102B	120B	150A	150A	150B	181C	181C	240B
037C	048C	060C	075A	075A	090A	103B	103B		150B	150B	180A	210A	210A	150E
048A	049C		075B	075B	090C	103C	103C		150D	150D	180B	210B	210B	180E
048C	060C		075C	075C		120A	120A		151B	151B		211B	211B	240E
049C			086C	086C		120B	120B		151C	151C		211C	211C	
060A			090A	090A		121B	121B		180A	180A		240A	240A	
060C			090B	090B		150C	150C		180B	180B		240B	240B	
			090C	090C					210C	210C		241B	241B	
			090D	090D					150E	150E		241C	241C	
			091D	091C								300B	300B	
			102C	091D								301C	301C	
			120C	102C								180E	180E	
				120C								210E	210E	
												211E	211E	
												240E	240E	
												241E	241E	
												300E	300E	
												151E	151E	
												181E	181E	
												301E	301E	

General Notes:

- ① If ordering Thru-The-Base options, the curb must be an April 1994 to present model curb to allow Thru-The-Base connections. The older curb models do not allow for these connections. The units will still fit the curb, but the Thru-The-Base connections will not be available.
- ② **TCD036A, TCD048A, TCD060A, WCD036A, WCD048A, WCD060A** are not 12½-25 Ton units. These units were manufactured in Ft. Smith, AR and will not fit any 12½-25 Ton curbs.
- ③ All horizontal 3-7½ ton, all horizontal 102C, and all horizontal 120C units will fit the downflow curbs, but BAYINSL101A kit must be installed across the bottom of the evaporator section of the unit to prevent condensate leakage into the space.
- ④ If another manufacturer's curb was used initially, the adapter curb may not fit.

Table LAC/IN-1-C — Convertible 3-10 Ton Curb Adapters

Model Number	Description
BAYQACB009A	Quick Adapt Roof Curb Converts BAYCURB021 to Convertible 3 - 5 Ton
BAYQACB010A	Quick Adapt Roof Curb Converts BAYCURB022 to Convertible 3 - 5 Ton
BAYQACB011A	Quick Adapt Roof Curb Converts BAYCURB022 to Convertible 6 - 10 Ton
BAYQACB012A	Quick Adapt Roof Curb Converts BAYCURB025 to Convertible 6 - 10 Ton
BAYQACB013A	Quick Adapt Roof Curb Converts BAYCURB026 to Convertible 6 - 10 Ton
BAYQACB044A	Quick Adapt Roof Curb Converts BAYCURB026 to BAYCURB027
BAYQACB500A	Quick Adapt Roof Curb Converts CRRFCURB001A01 to BAYCURB042A
BAYQACB501A	Quick Adapt Roof Curb Converts CRRFCURB001A01 to BAYCURB043A
BAYQACB502A	Quick Adapt Roof Curb Converts CRRFCURB001A03 to BAYCURB043A

Note: If another manufacturer's curb was used initially, the adapter curb may not fit

6-20 Tons Split System

Table LAC/IN-2-A — Allowable Elevation Difference: Cooling-only TTA above indoor unit

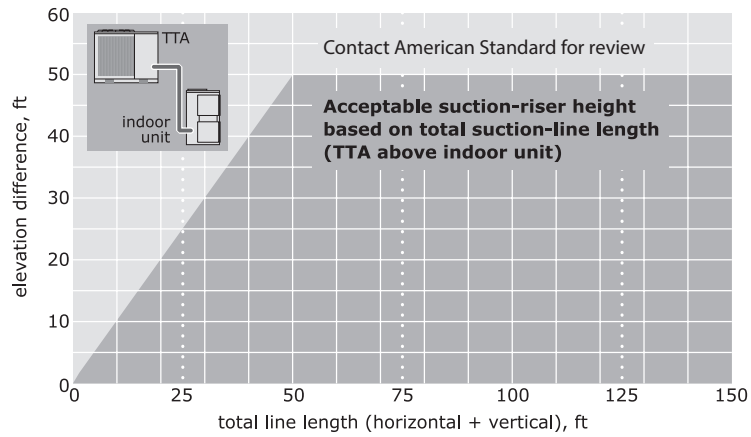

Table LAC/IN-2-B — Allowable Elevation Difference: TWA heat pump above indoor unit

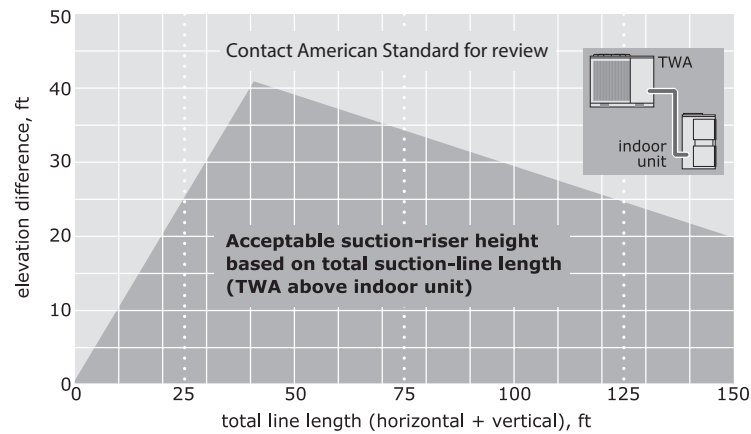
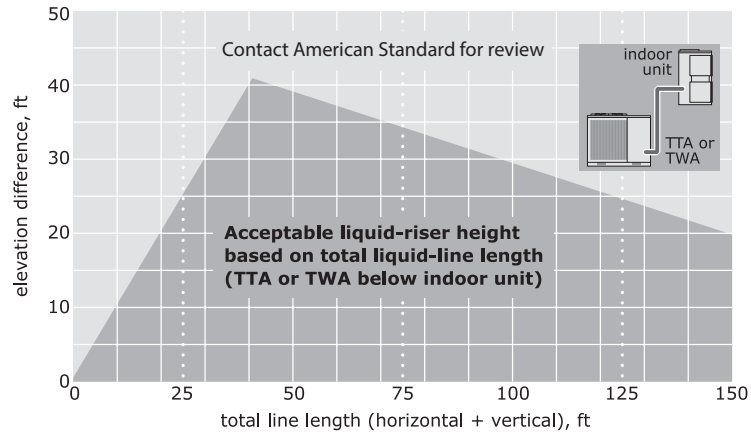

Table LAC/IN-2-C — Allowable Elevation Difference: TTA or TWA above indoor unit



Light Commercial Accessories/Information