

COOLING CAPACITY: 24,000 - 57,500 BTU/H

HEATING CAPACITY: 22,800 - 54,500 BTU/H

**HIGH-EFFICIENCY
 PACKAGED HEAT PUMPS
 2 TO 5 TONS
 UP TO 16 SEER**

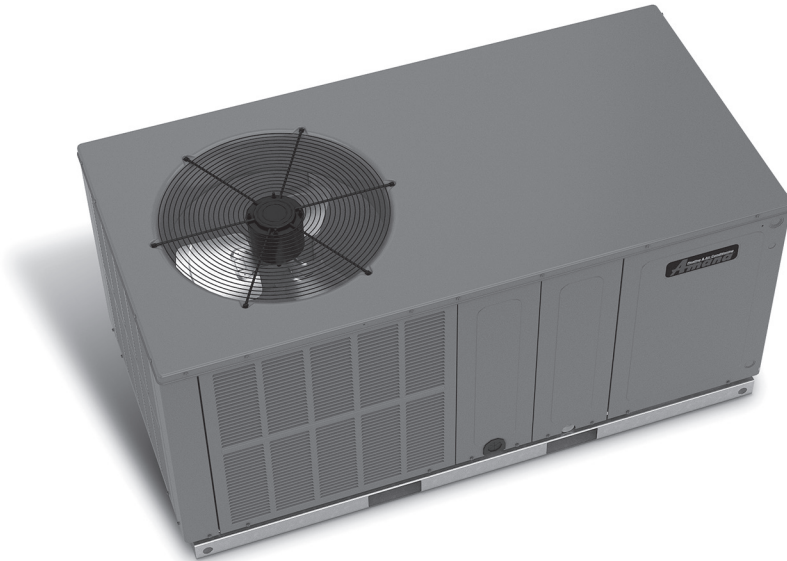

Contents

Nomenclature..... 2
 Product Specifications..... 3
 Expanded Cooling Data 4
 Expanded Heating Data..... 20
 Airflow Data 23
 Heat Kit Electrical Data..... 25
 Dimensions 26
 Wiring Diagrams 27
 Accessories 29

Standard Features

- High-efficiency scroll compressor
- Variable-speed ECM indoor blower motor
- Quiet horizontal discharge
- All-aluminum evaporator coil
- Copper tube / aluminum fin condenser coils
- Compressor sound blanket
- Totally enclosed, permanently lubricated condenser fan motor
- Fully charged system
- Electric heat kit available as a field-installed option
- AHRI Certified; ETL Listed

Cabinet Features

- Heavy-gauge galvanized-steel cabinet
- Attractive Architectural Gray powder-paint finish
- Aluminum foil-facing internal insulation reinforced with fiberglass scrim
- Cabinet air leakage less than 2.0% at 1.0 inch H₂O when tested in accordance with ASHRAE standard 193
- Cabinet air leakage less than 1.4% at 0.5 inch H₂O when tested in accordance with ASHRAE standard 193
- Fully insulated blower compartment with convenient access panels
- Louvered condenser coil protection
- One footprint for all tonnages



COMPANY WITH
 QUALITY SYSTEM
 CERTIFIED BY DNV GL
 ■ ISO 9001 ■

COMPANY WITH
 ENVIRONMENTAL SYSTEM
 CERTIFIED BY DNV GL
 ■ ISO 14001 ■

* Complete warranty details available from your local dealer or at www.amana-hac.com. To receive the Lifetime Compressor Limited Warranty (good for as long as you own your home), 2-Year Unit Replacement Limited Warranty and 10-Year Parts Limited Warranty, online registration must be completed within 60 days of installation. Online registration is not required in California or Quebec.

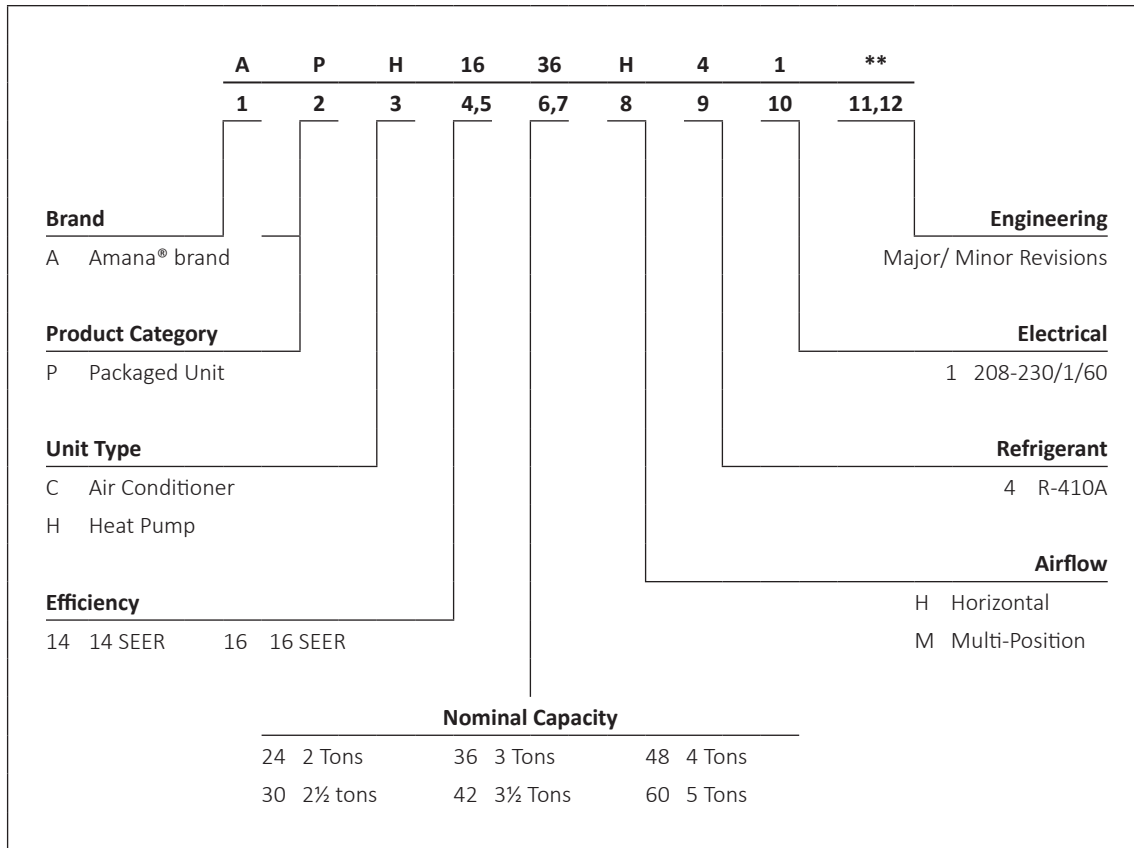

	APH16 24H41A*	APH16 30H41A*	APH16 36H41A*	APH16 36H41BA	APH16 36H41BB	APH16 42H41A*	APH16 42H41B*	APH16 48H41A*	APH16 60H41A*
COOLING CAPACITY									
Cooling Capacity (BTU/h)	24,000	28,400	36,000	35,600	35,600	42,000	42,000	46,000	57,500
Sensible BTU/h	18,200	21,400	27,000	27,000	27,400	30,000	30,000	34,600	40,500
SEER / EER	16.0 / 13.0	16.0 / 12.5	16.0 / 13.0	16.0 / 13.0	16.0 / 13.0	16.0 / 12.0	16.0 / 12.0	16.0 / 12.0	15.5/12
Decibels	76	76	78	78	78	78	79	80	80
AHRI Numbers	7953730	7953731	7953732	202327490	202327490	7953733	10259475	7953734	9008585
HEATING CAPACITY									
BTU/h (47°F)	22,800	27,600	32,200	32,200	32,200	40,000	40,000	44,000	54,500
C.O.P. (47°F)	3.8	3.8	3.8	3.8	3.8	3.8	3.8	3.8	3.6
BTU/h (17°F)	13,000	15,400	20,400	19,700	19,700	21,600	21,600	26,000	33,800
C.O.P. (17°F)	2.4	2.5	2.4	2.4	2.4	2.4	2.4	2.4	2.4
HSPF	8.0	8.0	8.0	8.0	8.0	8.0	8.2	8.0	8.2
EVAPORATOR MOTOR									
Type	ECM	ECM	ECM	ECM	ECM	ECM	ECM	ECM	ECM
Wheel (D x W)	10 x 8	10 x 8	10 x 8	10 x 8	10 x 8	10 x 8	10 x 8	10 x 8	11X8
Cooling CFM	875	1,050	1,200	1,200	1,200	1,300	1,300	1,600	1,700
Fan-Only CFM	800	950	1,100	1,100	1,100	1,200	1,200	1,400	1,600
RLA	4.3	4.3	4.3	4.3	4.3	4.3	4.3	6.8	6.8
No. of Speeds	Variable	Variable	Variable	Variable	Variable	Variable	Variable	Variable	Variable
Horsepower- RPM	½- 1,050	½- 1,050	½- 1,050	½- 1,050	½- 1,050	¾- 1,050	½- 1,050	¾- 1,050	¾- 1,050
EVAPORATOR COIL									
Face Area (ft2)	5.2	5.2	6.2	6.2	6.2	6.2	6.2	6.2	7
Rows Deep/ Fins per Inch	3/ 14	3/ 14	4/ 14	4/ 14	4/ 14	4/ 14	4/ 14	4/ 14	4/ 14
Indoor Metering Device Size	TXV	TXV	TXV	TXV	TXV	TXV	TXV	TXV	TXV
Filter Size (ft2)	20 x 20 x 1	20 x 25 x 1	25 x 25 x 1	25 x 25 x 1	25 x 25 x 1	(2) 20 x 20 x 1	(2) 20x20x1	(2) 20 x 20 x 1	(2) 20x25x1
Drain Size (NPT)	¾"	¾"	¾"	¾"	¾"	¾"	¾"	¾"	¾"
Refrigerant Charge (oz.)	116	116	170	170	170	170	170	170	175
CONDENSER FAN / COIL									
Horsepower- RPM	1/6- 815	1/6- 815	¼- 1075	¼- 1075	¼- 1075	¼- 1075	¼- 1075	¼- 1075	¼- 1075
RLA/LRA	1.1 / 1.7	1.1 / 1.7	1.5 / 3.0	1.3 / 3.0	1.6 / 3.5	1.4 / 2.9	1.4 / 2.9	1.4 / 2.9	1.4 / 2.9
Fan Diameter / # Fan Blades	22 / 3	22 / 3	22 / 4	22 / 4	22 / 4	22 / 4	22 / 4	22 / 4	22 / 4
Face Area (ft2)	14.3	14.3	17	17	17	17	17	17	19
Outdoor Metering Device Size	0.047	0.047	0.057	0.057	0.057	0.059	TXV	TXV	TXV
Rows Deep/ Fins per Inch	2 / 16	2 / 16	2 / 16	2 / 16	2 / 16	2 / 16	2 / 16	2 / 16	2 / 20
COMPRESSOR									
Quantity / Type	1 / Scroll	1 / Scroll	1 / Scroll	1 / Scroll	1 / Scroll	1 / Scroll	1 / Scroll	1 / Scroll	1 / Scroll
Stage	Single	Single	Single	Single	Single	Single	Two	Two	Two
Compressor RLA/LRA	12.8 / 58.3	14.1 / 73	16.7 / 79	15.7 / 72.2	15.7 / 72.2	17.9 / 112	17.9 / 96	21.2 / 104	27.1 / 152.9
ELECTRICAL DATA									
Voltage/Phase (60 Hz)	208-230/ 1	208-230/ 1	208-230/ 1	208-230/ 1	208-230/ 1	208-230/ 1	208-230/ 1	208-230/ 1	208-230/ 1
Indoor Blower FLA	4.3	4.3	4.3	4.3	4.3	4.3	4.3	6.8	6.8
Outdoor Fan RLA	1.1	1.1	1.4	1.3	1.6	1.4	1.4	1.4	1.4
Total Unit Amps	18.2	19.5	22.4	21.3	21.6	23.6	23.6	29.4	35.3
Min. Circuit Ampacity ¹	21	23	27	25.2	25.5	28	28	35	42.1
Min. Overcurrent Protection (amps) ²	30	35	40	40	40	45	45	50	60
OPERATING WEIGHTS (LBS)									
	315	315	375	375	375	375	375	400	405
SHIPPING WEIGHTS (LBS)									
	324	324	387	385	387	387	387	412	417

¹ Wire size should be determined in accordance with National Electrical Codes. Extensive wire runs will require larger wire sizes.

² Must use time-delay fuses or HACR-type circuit breakers of the same size as noted.

NOTE: Always check the S&R plate for electrical data on the unit being installed.

IDB	AIRFLOW	OUTDOOR AMBIENT TEMPERATURE																								
		65				75				85				95				105				115				
		59	63	67	71	59	63	67	71	59	63	67	71	59	63	67	71	59	63	67	71	59	63	67	71	
70	950	MBh	23.1	23.9	26.2	-	22.5	23.3	25.6	-	22.0	22.8	25.0	-	21.5	22.2	24.4	-	20.4	21.1	23.1	-	18.9	19.6	21.4	-
		S/T	0.74	0.62	0.43	-	0.76	0.64	0.44	-	0.78	0.66	0.45	-	0.81	0.68	0.47	-	0.84	0.70	0.49	-	0.85	0.71	0.49	-
		ΔT	16	14	11	-	17	14	11	-	17	14	11	-	17	15	11	-	17	14	11	-	15	13	10	-
		KW	1.42	1.45	1.50	-	1.54	1.57	1.62	-	1.64	1.67	1.73	-	1.72	1.76	1.82	-	1.80	1.84	1.90	-	1.86	1.91	1.97	-
		Amps	6.1	6.2	6.4	-	6.5	6.6	6.8	-	7.0	7.2	7.4	-	7.4	7.6	7.8	-	7.9	8.0	8.3	-	8.3	8.5	8.7	-
		Hi PR	218	234	247	-	244	263	278	-	278	299	316	-	316	340	360	-	356	383	404	-	393	423	447	-
Lo PR	110	117	127	-	116	123	135	-	120	128	140	-	127	135	147	-	133	141	154	-	137	146	159	-		
70	875	MBh	22.8	23.7	25.9	-	22.3	23.1	25.3	-	21.8	22.6	24.7	-	21.2	22.0	24.1	-	20.2	20.9	22.9	-	18.7	19.4	21.2	-
		S/T	0.72	0.60	0.42	-	0.75	0.63	0.43	-	0.77	0.64	0.45	-	0.79	0.66	0.46	-	0.82	0.69	0.48	-	0.83	0.69	0.48	-
		ΔT	17	15	11	-	18	15	12	-	18	15	12	-	18	15	12	-	17	15	11	-	16	14	11	-
		KW	1.42	1.45	1.50	-	1.53	1.57	1.62	-	1.63	1.67	1.72	-	1.72	1.76	1.82	-	1.79	1.83	1.90	-	1.86	1.90	1.97	-
		Amps	6.1	6.2	6.4	-	6.5	6.6	6.8	-	7.0	7.1	7.4	-	7.4	7.6	7.8	-	7.8	8.0	8.3	-	8.3	8.5	8.7	-
		Hi PR	217	234	247	-	244	262	277	-	277	298	315	-	315	339	358	-	355	382	403	-	392	422	446	-
Lo PR	109	116	127	-	116	123	134	-	120	128	139	-	126	134	147	-	132	141	154	-	137	145	159	-		
750	750	MBh	21.1	21.8	23.9	-	20.6	21.3	23.4	-	20.1	20.8	22.8	-	19.6	20.3	22.3	-	18.6	19.3	21.1	-	17.3	17.9	19.6	-
		S/T	0.70	0.58	0.40	-	0.72	0.60	0.42	-	0.74	0.62	0.43	-	0.77	0.64	0.44	-	0.79	0.66	0.46	-	0.80	0.67	0.46	-
		ΔT	18	16	12	-	18	16	12	-	18	16	12	-	18	16	12	-	18	16	12	-	17	15	11	-
		KW	1.38	1.41	1.46	-	1.49	1.53	1.58	-	1.59	1.63	1.68	-	1.67	1.71	1.77	-	1.75	1.79	1.85	-	1.81	1.85	1.91	-
		Amps	5.9	6.0	6.2	-	6.3	6.5	6.7	-	6.8	7.0	7.2	-	7.2	7.4	7.6	-	7.7	7.8	8.1	-	8.1	8.2	8.5	-
		Hi PR	211	227	239	-	236	254	268	-	269	289	305	-	306	329	348	-	344	370	391	-	380	409	432	-
Lo PR	106	113	123	-	112	119	130	-	116	124	135	-	122	130	142	-	128	136	149	-	133	141	154	-		

75	950	MBh	23.5	24.1	26.1	28.1	22.9	23.6	25.5	27.4	22.4	23.0	24.9	26.7	21.8	22.5	24.3	26.1	20.7	21.3	23.1	24.8	19.2	19.8	21.4	23.0
		S/T	0.84	0.75	0.57	0.37	0.87	0.78	0.59	0.38	0.89	0.80	0.60	0.39	0.92	0.82	0.62	0.40	0.96	0.85	0.65	0.42	0.96	0.86	0.65	0.42
		ΔT	19	18	14	10	19	18	15	10	19	18	15	10	19	18	15	10	19	18	14	10	18	16	14	9
		KW	1.43	1.47	1.51	1.56	1.55	1.58	1.64	1.69	1.65	1.69	1.74	1.80	1.74	1.78	1.84	1.90	1.81	1.86	1.92	1.98	1.88	1.92	1.99	2.06
		Amps	6.1	6.2	6.4	6.6	6.6	6.7	6.9	7.1	7.1	7.2	7.4	7.7	7.5	7.7	7.9	8.2	7.9	8.1	8.4	8.7	8.4	8.6	8.8	9.1
		Hi PR	220	237	250	261	247	266	280	292	281	302	319	333	320	344	363	379	360	387	409	426	397	428	451	471
Lo PR	111	118	129	137	117	125	136	145	122	129	141	151	128	136	148	158	134	143	156	166	139	147	161	171		
75	875	MBh	23.2	23.9	25.9	27.8	22.7	23.4	25.3	27.1	22.1	22.8	24.7	26.5	21.6	22.2	24.1	25.8	20.5	21.1	22.9	24.5	19.0	19.6	21.2	22.7
		S/T	0.82	0.74	0.56	0.36	0.85	0.76	0.58	0.37	0.87	0.78	0.59	0.38	0.90	0.81	0.61	0.39	0.94	0.84	0.63	0.41	0.94	0.84	0.64	0.41
		ΔT	20	18	15	10	20	19	15	11	20	19	15	11	20	19	15	11	20	19	15	11	19	17	14	10
		KW	1.43	1.46	1.51	1.56	1.54	1.58	1.63	1.69	1.65	1.68	1.74	1.80	1.73	1.77	1.83	1.90	1.81	1.85	1.91	1.98	1.87	1.92	1.98	2.05
		Amps	6.1	6.2	6.4	6.6	6.5	6.7	6.9	7.1	7.0	7.2	7.4	7.7	7.5	7.6	7.9	8.1	7.9	8.1	8.3	8.6	8.3	8.5	8.8	9.1
		Hi PR	219	236	249	260	246	265	280	292	280	301	318	332	319	343	362	378	358	386	407	425	396	426	450	469
Lo PR	110	118	128	137	117	124	136	144	121	129	141	150	127	136	148	158	134	142	155	165	138	147	160	171		
750	750	MBh	21.4	22.1	23.9	25.6	20.9	21.6	23.3	25.0	20.4	21.0	22.8	24.4	19.9	20.5	22.2	23.8	18.9	19.5	21.1	22.7	17.5	18.1	19.6	21.0
		S/T	0.79	0.71	0.54	0.35	0.82	0.74	0.56	0.36	0.84	0.75	0.57	0.37	0.87	0.78	0.59	0.38	0.90	0.81	0.61	0.39	0.91	0.81	0.62	0.40
		ΔT	21	19	16	11	21	19	16	11	21	19	16	11	21	20	16	11	21	19	16	11	20	18	15	10
		KW	1.40	1.43	1.47	1.52	1.51	1.54	1.59	1.64	1.60	1.64	1.69	1.75	1.69	1.73	1.79	1.85	1.76	1.80	1.86	1.93	1.83	1.87	1.93	2.00
		Amps	6.0	6.1	6.3	6.5	6.4	6.5	6.7	6.9	6.9	7.0	7.2	7.5	7.3	7.5	7.7	7.9	7.7	7.9	8.1	8.4	8.1	8.3	8.6	8.9
		Hi PR	213	229	242	252	239	257	271	283	271	292	308	322	309	333	351	366	348	374	395	412	384	413	437	455
Lo PR	107	114	124	133	113	120	132	140	118	125	137	146	124	132	144	153	130	138	150	160	134	143	156	166		

IDB = Entering Indoor Dry Bulb Temperature
 High and low pressures are measured at the liquid and suction access fittings.
 Design Subcooling, 5-7 °F @ the liquid access fitting connection AHR1 95 test conditions. Design Superheat 15-18°F @ the compressor suction access fitting connection.
 Shaded area reflects AHR1 (TV) conditions.
 KW = Total system power
 Amps: Unit amps (comp.+ evaporator + condenser fan motors)

IDB	AIRFLOW	OUTDOOR AMBIENT TEMPERATURE												105												115																																							
		65						75						85						95						105						115																																	
		59	63	67	71	75	79	59	63	67	71	75	79	59	63	67	71	75	79	59	63	67	71	75	79	59	63	67	71	75	79	59	63	67	71	75	79																												
ENTERING INDOOR WET BULB TEMPERATURE																																																																	
80	MBh	23.9	24.4	26.1	27.9	23.3	23.8	25.5	27.2	22.8	23.3	24.8	26.6	22.2	22.7	24.2	25.9	21.1	21.6	23.0	24.6	19.5	20.0	21.3	22.8	22.2	22.7	24.2	25.9	21.1	21.6	23.0	24.6	19.5	20.0	21.3	22.8	22.2	22.7	24.2	25.9	21.1	21.6	23.0	24.6	19.5	20.0	21.3	22.8	22.2	22.7	24.2	25.9	21.1	21.6	23.0	24.6	19.5	20.0	21.3	22.8				
	S/T	0.92	0.86	0.70	0.53	0.95	0.89	0.73	0.54	0.98	0.92	0.75	0.56	1.00	0.95	0.77	0.58	1.00	0.98	0.80	0.60	1.00	1.00	0.81	0.60	1.00	0.95	0.77	0.58	1.00	0.98	0.80	0.60	1.00	1.00	0.81	0.60	1.00	0.95	0.77	0.58	1.00	0.98	0.80	0.60	1.00	1.00	0.81	0.60	1.00	0.95	0.77	0.58	1.00	0.98	0.80	0.60	1.00	1.00	0.81	0.60				
	ΔT	21	20	18	14	22	21	18	14	22	21	18	14	21	21	18	14	20	20	20	18	14	19	19	17	13	21	21	18	14	20	20	20	18	14	19	19	17	13	21	21	18	14	20	20	20	18	14	19	19	17	13	21	21	18	14	20	20	20	18	14	19	19	17	13
	KW	1.45	1.48	1.53	1.58	1.56	1.60	1.65	1.70	1.66	1.70	1.76	1.82	1.75	1.79	1.85	1.92	1.83	1.87	1.94	2.00	1.90	1.94	2.01	2.08	1.75	1.79	1.85	1.92	1.83	1.87	1.94	2.00	1.90	1.94	2.01	2.08	1.75	1.79	1.85	1.92	1.83	1.87	1.94	2.00	1.90	1.94	2.01	2.08	1.75	1.79	1.85	1.92	1.83	1.87	1.94	2.00	1.90	1.94	2.01	2.08				
	Amps	6.2	6.3	6.5	6.7	6.6	6.8	7.0	7.2	7.1	7.3	7.5	7.8	7.6	7.7	8.0	8.2	8.0	8.2	8.4	8.7	8.4	8.6	8.9	9.2	7.6	7.7	8.0	8.2	8.0	8.2	8.4	8.7	8.4	8.6	8.9	9.2	7.6	7.7	8.0	8.2	8.0	8.2	8.4	8.7	8.4	8.6	8.9	9.2	7.6	7.7	8.0	8.2	8.0	8.2	8.4	8.7	8.4	8.6	8.9	9.2				
	Hi PR	221	239	252	263	249	268	283	295	283	305	322	336	323	347	367	383	363	391	413	430	401	432	456	476	323	347	367	383	363	391	413	430	401	432	456	476	323	347	367	383	363	391	413	430	401	432	456	476	323	347	367	383	363	391	413	430	401	432	456	476				
	Lo PR	112	119	130	138	118	126	137	146	123	131	143	152	129	137	150	160	135	144	157	167	140	149	163	173	129	137	150	160	135	144	157	167	140	149	163	173	129	137	150	160	135	144	157	167	140	149	163	173	129	137	150	160	135	144	157	167	140	149	163	173				
	MBh	23.6	24.1	25.8	27.6	23.1	23.6	25.2	26.9	22.5	23.0	24.6	26.3	22.0	22.5	24.0	25.7	20.9	21.3	22.8	24.4	19.3	19.8	21.1	22.6	22.0	22.5	24.0	25.7	20.9	21.3	22.8	24.4	19.3	19.8	21.1	22.6	22.0	22.5	24.0	25.7	20.9	21.3	22.8	24.4	19.3	19.8	21.1	22.6	22.0	22.5	24.0	25.7	20.9	21.3	22.8	24.4	19.3	19.8	21.1	22.6				
	S/T	0.90	0.85	0.69	0.51	0.94	0.88	0.71	0.53	0.96	0.90	0.73	0.55	0.99	0.93	0.76	0.56	1.00	0.96	0.78	0.59	1.00	0.97	0.79	0.59	0.99	0.93	0.76	0.56	1.00	0.96	0.78	0.59	1.00	0.97	0.79	0.59	0.99	0.93	0.76	0.56	1.00	0.96	0.78	0.59	1.00	0.97	0.79	0.59	0.99	0.93	0.76	0.56	1.00	0.96	0.78	0.59	1.00	0.97	0.79	0.59				
	ΔT	22	21	19	15	23	22	19	15	23	22	19	15	23	22	19	15	22	22	22	19	15	20	20	18	14	23	22	19	15	22	22	22	19	15	20	20	18	14	23	22	19	15	22	22	22	19	15	20	20	18	14	23	22	19	15	22	22	22	19	15	20	20	18	14
	KW	1.44	1.47	1.52	1.57	1.56	1.59	1.65	1.70	1.66	1.70	1.75	1.81	1.75	1.79	1.85	1.91	1.82	1.87	1.93	2.00	1.89	1.93	2.00	2.07	1.75	1.79	1.85	1.91	1.82	1.87	1.93	2.00	1.89	1.93	2.00	2.07	1.75	1.79	1.85	1.91	1.82	1.87	1.93	2.00	1.89	1.93	2.00	2.07	1.75	1.79	1.85	1.91	1.82	1.87	1.93	2.00	1.89	1.93	2.00	2.07				
	Amps	6.2	6.3	6.5	6.7	6.6	6.7	6.9	7.2	7.1	7.3	7.5	7.7	7.5	7.7	8.0	8.2	8.0	8.2	8.4	8.7	8.4	8.6	8.9	9.2	7.5	7.7	8.0	8.2	8.0	8.2	8.4	8.7	8.4	8.6	8.9	9.2	7.5	7.7	8.0	8.2	8.0	8.2	8.4	8.7	8.4	8.6	8.9	9.2	7.5	7.7	8.0	8.2	8.0	8.2	8.4	8.7	8.4	8.6	8.9	9.2				
Hi PR	221	238	252	262	248	267	282	295	283	304	321	335	322	346	366	381	362	390	411	429	400	431	455	474	322	346	366	381	362	390	411	429	400	431	455	474	322	346	366	381	362	390	411	429	400	431	455	474	322	346	366	381	362	390	411	429	400	431	455	474					
Lo PR	112	119	130	138	118	125	137	146	123	130	142	152	129	137	150	159	135	144	157	167	140	148	162	173	129	137	150	159	135	144	157	167	140	148	162	173	129	137	150	159	135	144	157	167	140	148	162	173	129	137	150	159	135	144	157	167	140	148	162	173					
MBh	21.8	22.3	23.8	25.5	21.3	21.8	23.3	24.9	20.8	21.3	22.7	24.3	20.3	20.7	22.2	23.7	19.3	19.7	21.0	22.5	17.9	18.2	19.5	20.8	20.3	20.7	22.2	23.7	19.3	19.7	21.0	22.5	17.9	18.2	19.5	20.8	20.3	20.7	22.2	23.7	19.3	19.7	21.0	22.5	17.9	18.2	19.5	20.8	20.3	20.7	22.2	23.7	19.3	19.7	21.0	22.5	17.9	18.2	19.5	20.8					
S/T	0.87	0.82	0.66	0.50	0.90	0.85	0.69	0.51	0.92	0.87	0.71	0.53	0.95	0.90	0.73	0.54	0.99	0.93	0.76	0.57	1.00	0.94	0.76	0.57	0.95	0.90	0.73	0.54	0.99	0.93	0.76	0.57	1.00	0.94	0.76	0.57	0.95	0.90	0.73	0.54	0.99	0.93	0.76	0.57	1.00	0.94	0.76	0.57	0.95	0.90	0.73	0.54	0.99	0.93	0.76	0.57	1.00	0.94	0.76	0.57					
ΔT	23	22	19	15	24	23	20	16	24	23	20	16	24	23	20	16	23	22	20	16	22	21	18	15	24	23	20	16	23	22	20	16	22	21	18	15	24	23	20	16	23	22	20	16	22	21	18	15	24	23	20	16	23	22	20	16	22	21	18	15					
KW	1.41	1.44	1.48	1.53	1.52	1.55	1.60	1.66	1.62	1.65	1.71	1.77	1.70	1.74	1.80	1.86	1.78	1.82	1.88	1.94	1.84	1.88	1.95	2.02	1.70	1.74	1.80	1.86	1.78	1.82	1.88	1.94	1.84	1.88	1.95	2.02	1.70	1.74	1.80	1.86	1.78	1.82	1.88	1.94	1.84	1.88	1.95	2.02	1.70	1.74	1.80	1.86	1.78	1.82	1.88	1.94	1.84	1.88	1.95	2.02					
Amps	6.0	6.1	6.3	6.5	6.4	6.6	6.8	7.0	6.9	7.1	7.3	7.5	7.4	7.5	7.7	8.0	7.8	8.0	8.2	8.5	8.2	8.4	8.6	9.0	7.4	7.5	7.7	8.0	7.8	8.0	8.2	8.5	8.2	8.4	8.6	9.0	7.4	7.5	7.7	8.0	7.8	8.0	8.2	8.5	8.2	8.4	8.6	9.0	7.4	7.5	7.7	8.0	7.8	8.0	8.2	8.5	8.2	8.4	8.6	9.0					
Hi PR	215	231	244	255	241	259	274	286	274	295	311	325	312	336	355	370	351	378	399	416	388	418	441	460	312	336	355	370	351	378	399	416	388	418	441	460	312	336	355	370	351	378	399	416	388	418	441	460	312	336	355	370	351	378	399	416	388	418	441	460					
Lo PR	108	115	126	134	114	122	133	141	119	126	138	147	125	133	145	154	131	139	152	162	135	144	157	167	125	133	145	154	131	139	152	162	135	144	157	167	125	133	145	154	131	139	152	162	135	144	157	167	125	133	145	154	131	139	152	162	135	144	157	167					
85	MBh	24.3	24.8	25.9	27.7	23.7	24.2	25.3	27.0	23.2	23.6	24.7	26.4	22.6	23.0	24.1	25.7	21.5	21.9	22.9	24.4	19.9	20.3	21.2	22.6	22.6	23.0	24.1	25.7	21.5	21.9	22.9	24.4	19.9	20.3	21.2	22.6	22.6	23.0	24.1	25.7	21.5	21.9	22.9	24.4	19.9	20.3	21.2	22.6	22.6	23.0	24.1	25.7	21.5	21.9	22.9	24.4	19.9	20.3	21.2	22.6				
	S/T	0.96	0.93	0.84	0.68	1.00	0.96	0.87	0.71	1.00	0.99	0.89	0.72	1.00	1.00	0.92	0.75	1.00	1.00	0.96	0.78	1.00	1.00	0.96	0.78	1.00	1.00	0.92	0.75	1.00	1.00	0.96	0.78	1.00	1.00	0.96	0.78	1.00	1.00</																										

IDB	AIRFLOW	OUTDOOR AMBIENT TEMPERATURE																												
		65				75				85				95				105				115								
		59	63	67	71	59	63	67	71	59	63	67	71	59	63	67	71	59	63	67	71	59	63	67	71					
70	1180	MBh	27.8	28.8	31.6	-	27.2	28.2	30.9	-	26.5	27.5	30.1	-	25.9	26.8	29.4	-	24.6	25.5	27.9	-	24.6	25.5	27.9	-	22.8	23.6	25.9	-
		S/T	0.75	0.63	0.44	-	0.78	0.65	0.45	-	0.80	0.67	0.46	-	0.83	0.69	0.48	-	0.86	0.72	0.50	-	0.86	0.72	0.50	-	0.87	0.72	0.50	-
		ΔT	16	14	11	-	17	14	11	-	17	14	11	-	17	14	11	-	16	14	11	-	16	14	11	-	15	13	10	-
		KW	1.74	1.78	1.84	-	1.88	1.92	1.99	-	2.01	2.05	2.12	-	2.11	2.16	2.24	-	2.21	2.26	2.33	-	2.21	2.26	2.33	-	2.29	2.34	2.42	-
		Amps	7.3	7.5	7.7	-	7.9	8.0	8.3	-	8.5	8.7	8.9	-	9.0	9.2	9.5	-	9.5	9.8	10.1	-	9.5	9.8	10.1	-	10.1	10.3	10.6	-
	1050	Hi PR	228	246	260	-	256	276	291	-	292	314	331	-	332	357	377	-	374	402	425	-	374	402	425	-	413	444	469	-
		Lo PR	109	116	127	-	115	123	134	-	120	128	139	-	126	134	146	-	132	140	153	-	132	140	153	-	137	145	159	-
		MBh	27.0	28.0	30.7	-	26.4	27.4	30.0	-	25.8	26.7	29.3	-	25.1	26.1	28.5	-	23.9	24.7	27.1	-	23.9	24.7	27.1	-	22.1	22.9	25.1	-
		S/T	0.72	0.60	0.42	-	0.75	0.62	0.43	-	0.76	0.64	0.44	-	0.79	0.66	0.46	-	0.82	0.68	0.47	-	0.82	0.68	0.47	-	0.83	0.69	0.48	-
		ΔT	17	15	11	-	17	15	11	-	17	15	11	-	17	15	11	-	17	15	11	-	17	15	11	-	16	14	11	-
925	KW	1.73	1.77	1.82	-	1.87	1.91	1.97	-	1.99	2.03	2.10	-	2.10	2.14	2.22	-	2.19	2.24	2.31	-	2.19	2.24	2.31	-	2.27	2.32	2.40	-	
	Amps	7.3	7.4	7.6	-	7.8	8.0	8.2	-	8.4	8.6	8.8	-	8.9	9.1	9.4	-	9.5	9.7	10.0	-	9.5	9.7	10.0	-	10.0	10.2	10.5	-	
	Hi PR	226	243	257	-	254	273	288	-	289	311	328	-	329	354	374	-	370	398	420	-	370	398	420	-	409	440	464	-	
	Lo PR	108	115	126	-	114	122	133	-	119	126	138	-	125	133	145	-	131	139	152	-	131	139	152	-	135	144	157	-	
	MBh	25.7	26.6	29.1	-	25.1	26.0	28.5	-	24.5	25.4	27.8	-	23.9	24.7	27.1	-	22.7	23.5	25.8	-	22.7	23.5	25.8	-	21.0	21.8	23.9	-	

75	1180	MBh	28.3	29.1	31.5	33.9	27.6	28.5	30.8	33.1	27.0	27.8	30.1	32.3	26.3	27.1	29.3	31.5	25.0	25.8	27.9	29.9	23.2	23.9	25.8	27.7
		S/T	0.86	0.77	0.58	0.37	0.89	0.79	0.60	0.39	0.91	0.82	0.62	0.40	0.94	0.84	0.64	0.41	0.98	0.87	0.66	0.43	0.98	0.88	0.67	0.43
		ΔT	19	17	14	10	19	18	14	10	19	18	14	10	19	18	15	10	20	18	14	10	18	16	13	9
		KW	1.76	1.80	1.85	1.92	1.90	1.94	2.01	2.07	2.02	2.07	2.14	2.21	2.13	2.18	2.26	2.33	2.23	2.28	2.36	2.44	2.31	2.36	2.44	2.53
		Amps	7.4	7.5	7.8	8.0	7.9	8.1	8.3	8.6	8.5	8.7	9.0	9.3	9.1	9.3	9.6	9.9	9.6	9.8	10.1	10.5	10.1	10.4	10.7	11.1
	1050	Hi PR	231	248	262	274	259	279	294	307	295	317	335	349	336	361	381	398	377	406	429	447	417	449	474	494
		Lo PR	110	117	128	137	117	124	135	144	121	129	141	150	127	135	148	157	133	142	155	165	138	147	160	171
		MBh	27.5	28.3	30.6	32.9	26.8	27.6	29.9	32.1	26.2	27.0	29.2	31.3	25.6	26.3	28.5	30.6	24.3	25.0	27.1	29.0	22.5	23.2	25.1	26.9
		S/T	0.82	0.73	0.55	0.36	0.85	0.76	0.57	0.37	0.87	0.78	0.59	0.38	0.90	0.80	0.61	0.39	0.93	0.83	0.63	0.41	0.94	0.84	0.64	0.41
		ΔT	20	18	15	10	20	18	15	10	20	18	15	10	20	18	15	10	20	18	15	10	18	17	14	10
925	KW	1.74	1.78	1.84	1.90	1.88	1.92	1.99	2.06	2.01	2.05	2.12	2.19	2.11	2.16	2.24	2.31	2.21	2.26	2.34	2.42	2.29	2.34	2.42	2.51	
	Amps	7.3	7.5	7.7	8.0	7.9	8.0	8.3	8.5	8.5	8.7	8.9	9.2	9.0	9.2	9.5	9.8	9.5	9.8	10.1	10.4	10.1	10.3	10.6	11.0	
	Hi PR	229	246	260	271	256	276	291	304	292	314	331	346	332	357	377	394	374	402	425	443	413	444	469	489	
	Lo PR	109	116	127	135	115	123	134	143	120	128	139	148	126	134	146	156	132	141	153	163	137	145	159	169	
	MBh	26.1	26.9	29.1	31.2	25.5	26.3	28.4	30.5	24.9	25.6	27.7	29.8	24.3	25.0	27.1	29.0	23.1	23.8	25.7	27.6	21.4	22.0	23.8	25.6	

IDB = Entering Indoor Dry Bulb Temperature
 High and low pressures are measured at the liquid and suction access fittings.
 Design Subcooling, 5-7 °F @ the liquid access fitting connection AHR1 95 test conditions. Design Superheat 15-18°F @ the compressor suction access fitting connection.
 Shaded area reflects AHR1 (TV) conditions.
 kW = Total system power
 Amps: Unit amps (comp.+ evaporator + condenser fan motors)

IDB	Airflow	Outdoor Ambient Temperature												105°F												115°F																																																																																																																																																																																																																																																																																																																																																																																																																																																																																																																																																																																																																																																																																																																																																																																																																																																																																																																																																																																																																																																																																																																																																											
		65°F						75°F						85°F						95°F						105°F						115°F																																																																																																																																																																																																																																																																																																																																																																																																																																																																																																																																																																																																																																																																																																																																																																																																																																																																																																																																																																																																																																																																																																																																																					
		59	63	67	71	75	79	59	63	67	71	75	79	59	63	67	71	75	79	59	63	67	71	75	79	59	63	67	71	75	79	59	63	67	71	75	79																																																																																																																																																																																																																																																																																																																																																																																																																																																																																																																																																																																																																																																																																																																																																																																																																																																																																																																																																																																																																																																																																																																																																
80	1180	MBh	28.8	29.4	31.4	33.6	36.0	38.4	40.8	43.2	45.6	48.0	27.5	28.1	30.0	32.1	34.2	36.3	38.4	40.5	42.6	44.7	46.8	48.9	26.8	27.4	29.3	31.3	33.3	35.4	37.5	39.6	41.7	43.8	45.9	48.0	25.5	26.0	27.8	29.7	31.6	33.5	35.4	37.3	39.2	41.1	43.0	44.9	46.8	48.7	50.6	52.5	54.4	56.3	58.2	60.1	23.6	24.1	25.7	27.5	29.3	31.1	32.9	34.7	36.5	38.3	40.1	41.9	43.7	45.5	47.3	49.1	50.9	52.7	54.5	56.3	58.1	59.9	61.7	63.5	65.3	67.1	68.9	70.7	72.5	74.3	76.1	77.9	79.7	81.5	83.3	85.1	86.9	88.7	90.5	92.3	94.1	95.9	97.7	99.5	101.3	103.1	104.9	106.7	108.5	110.3	112.1	113.9	115.7	117.5	119.3	121.1	122.9	124.7	126.5	128.3	130.1	131.9	133.7	135.5	137.3	139.1	140.9	142.7	144.5	146.3	148.1	149.9	151.7	153.5	155.3	157.1	158.9	160.7	162.5	164.3	166.1	167.9	169.7	171.5	173.3	175.1	176.9	178.7	180.5	182.3	184.1	185.9	187.7	189.5	191.3	193.1	194.9	196.7	198.5	200.3	202.1	203.9	205.7	207.5	209.3	211.1	212.9	214.7	216.5	218.3	220.1	221.9	223.7	225.5	227.3	229.1	230.9	232.7	234.5	236.3	238.1	239.9	241.7	243.5	245.3	247.1	248.9	250.7	252.5	254.3	256.1	257.9	259.7	261.5	263.3	265.1	266.9	268.7	270.5	272.3	274.1	275.9	277.7	279.5	281.3	283.1	284.9	286.7	288.5	290.3	292.1	293.9	295.7	297.5	299.3	301.1	302.9	304.7	306.5	308.3	310.1	311.9	313.7	315.5	317.3	319.1	320.9	322.7	324.5	326.3	328.1	329.9	331.7	333.5	335.3	337.1	338.9	340.7	342.5	344.3	346.1	347.9	349.7	351.5	353.3	355.1	356.9	358.7	360.5	362.3	364.1	365.9	367.7	369.5	371.3	373.1	374.9	376.7	378.5	380.3	382.1	383.9	385.7	387.5	389.3	391.1	392.9	394.7	396.5	398.3	400.1	401.9	403.7	405.5	407.3	409.1	410.9	412.7	414.5	416.3	418.1	419.9	421.7	423.5	425.3	427.1	428.9	430.7	432.5	434.3	436.1	437.9	439.7	441.5	443.3	445.1	446.9	448.7	450.5	452.3	454.1	455.9	457.7	459.5	461.3	463.1	464.9	466.7	468.5	470.3	472.1	473.9	475.7	477.5	479.3	481.1	482.9	484.7	486.5	488.3	490.1	491.9	493.7	495.5	497.3	499.1	500.9	502.7	504.5	506.3	508.1	509.9	511.7	513.5	515.3	517.1	518.9	520.7	522.5	524.3	526.1	527.9	529.7	531.5	533.3	535.1	536.9	538.7	540.5	542.3	544.1	545.9	547.7	549.5	551.3	553.1	554.9	556.7	558.5	560.3	562.1	563.9	565.7	567.5	569.3	571.1	572.9	574.7	576.5	578.3	580.1	581.9	583.7	585.5	587.3	589.1	590.9	592.7	594.5	596.3	598.1	599.9	601.7	603.5	605.3	607.1	608.9	610.7	612.5	614.3	616.1	617.9	619.7	621.5	623.3	625.1	626.9	628.7	630.5	632.3	634.1	635.9	637.7	639.5	641.3	643.1	644.9	646.7	648.5	650.3	652.1	653.9	655.7	657.5	659.3	661.1	662.9	664.7	666.5	668.3	670.1	671.9	673.7	675.5	677.3	679.1	680.9	682.7	684.5	686.3	688.1	689.9	691.7	693.5	695.3	697.1	698.9	700.7	702.5	704.3	706.1	707.9	709.7	711.5	713.3	715.1	716.9	718.7	720.5	722.3	724.1	725.9	727.7	729.5	731.3	733.1	734.9	736.7	738.5	740.3	742.1	743.9	745.7	747.5	749.3	751.1	752.9	754.7	756.5	758.3	760.1	761.9	763.7	765.5	767.3	769.1	770.9	772.7	774.5	776.3	778.1	779.9	781.7	783.5	785.3	787.1	788.9	790.7	792.5	794.3	796.1	797.9	799.7	801.5	803.3	805.1	806.9	808.7	810.5	812.3	814.1	815.9	817.7	819.5	821.3	823.1	824.9	826.7	828.5	830.3	832.1	833.9	835.7	837.5	839.3	841.1	842.9	844.7	846.5	848.3	850.1	851.9	853.7	855.5	857.3	859.1	860.9	862.7	864.5	866.3	868.1	869.9	871.7	873.5	875.3	877.1	878.9	880.7	882.5	884.3	886.1	887.9	889.7	891.5	893.3	895.1	896.9	898.7	900.5	902.3	904.1	905.9	907.7	909.5	911.3	913.1	914.9	916.7	918.5	920.3	922.1	923.9	925.7	927.5	929.3	931.1	932.9	934.7	936.5	938.3	940.1	941.9	943.7	945.5	947.3	949.1	950.9	952.7	954.5	956.3	958.1	959.9	961.7	963.5	965.3	967.1	968.9	970.7	972.5	974.3	976.1	977.9	979.7	981.5	983.3	985.1	986.9	988.7	990.5	992.3	994.1	995.9	997.7	999.5	1001.3	1003.1	1004.9	1006.7	1008.5	1010.3	1012.1	1013.9	1015.7	1017.5	1019.3	1021.1	1022.9	1024.7	1026.5	1028.3	1030.1	1031.9	1033.7	1035.5	1037.3	1039.1	1040.9	1042.7	1044.5	1046.3	1048.1	1049.9	1051.7	1053.5	1055.3	1057.1	1058.9	1060.7	1062.5	1064.3	1066.1	1067.9	1069.7	1071.5	1073.3	1075.1	1076.9	1078.7	1080.5	1082.3	1084.1	1085.9	1087.7	1089.5	1091.3	1093.1	1094.9	1096.7	1098.5	1100.3	1102.1	1103.9	1105.7	1107.5	1109.3	1111.1	1112.9	1114.7	1116.5	1118.3	1120.1	1121.9	1123.7	1125.5	1127.3	1129.1	1130.9	1132.7	1134.5	1136.3	1138.1	1139.9	1141.7	1143.5	1145.3	1147.1	1148.9	1150.7	1152.5	1154.3	1156.1	1157.9	1159.7	1161.5	1163.3	1165.1	1166.9	1168.7	1170.5	1172.3	1174.1	1175.9	1177.7	1179.5	1181.3	1183.1	1184.9	1186.7	1188.5	1190.3	1192.1	1193.9	1195.7	1197.5	1199.3	1201.1	1202.9	1204.7	1206.5	1208.3	1210.1	1211.9	1213.7	1215.5	1217.3	1219.1	1220.9	1222.7	1224.5	1226.3	1228.1	1229.9	1231.7	1233.5	1235.3	1237.1	1238.9	1240.7	1242.5	1244.3	1246.1	1247.9	1249.7	1251.5	1253.3	1255.1	1256.9	1258.7	1260.5	1262.3	1264.1	1265.9	1267.7	1269.5	1271.3	1273.1	1274.9	1276.7	1278.5	1280.3	1282.1	1283.9	1285.7	1287.5	1289.3	1291.1	1292.9	1294.7	1296.5	1298.3	1299.9	1301.7	1303.5	1305.3	1307.1	1308.9	1310.7	1312.5	1314.3	1316.1	1317.9	1319.7	1321.5	1323.3	1325.1	1326.9	1328.7	1330.5	1332.3	1334.1	1335.9	1337.7	1339.5	1341.3	1343.1	1344.9	1346.7	1348.5	1350.3	1352.1	1353.9	1355.7	1357.5	1359.3	1361.1	1362.9	1364.7	1366.5	1368.3	1370.1	1371.9	1373.7	1375.5	1377.3	1379.1	1380.9	1382.7	1384.5	1386.3	1388.1	1389.9	1391.7	1393.5	1395.3	1397.1	1398.9	1400.7	1402.5	1404.3	1406.1	1407.9	1409.7	1411.5	1413.3	1415.1	1416.9	1418.7	1420.5	1422.3	1424.1	1425.9	1427.7	1429.5	1431.3	1433.1	1434.9	1436.7	1438.5	1440.3	1442.1	1443.9	1445.7	1447.5	1449.3	1451.1	1452.9	1454.7	1456.5	1458.3	1460.1	1461.9	1463.7	1465.5	1467.3	1469.1	1470.9	1472.7	1474.5	1476.3	1478.1	1479.9	1481.7	1483.5	1485.3	1487.1	1488.9	1490.7	1492.5	1494.3	1496.1	1497.9	1499.7	1501.5	1503.3	1505.1	1506.9	1508.7	1510.5	1512.3	1514.1	1515.9	1517.7	1519.5	1521.3	1523.1	1524.9	1526.7	1528.5	1530.3	1532.1	1533.9	1535.7	1537.5	1539.3	1541.1	1542.9	1544.7	1546.5	1548.3	1550.1	1551.9	1553.7	1555.5	1557.3	1559.1	1560.9	1562.7	1564.5	1566.3	1568.1	1569.9	1571.7	1573.5	1575.3	1577.1	1578.9	1580.7	1582.5	1584.3	1586.1	1587.9	1589.7	1591.5	1593.3	1595.1	1596.9	1598.7	1600.5	1602.3	1604.1	1605.9	1607.7	1609.5	1611.3	1613.1	1614.9	1616.7	1618.5	1620.3	1622.1	1623.9	1625.7	1627.5	1629.3	1631.1	1632.9	1634.7	1636.5	1638.3	1640.1	1641.9	1643.7	1645.5	1647.3	1649.1	1650.9	1652.7	1654.5	1656.3	1658.1	1659.9	1661.7	1663.5	1665.3	1667.1	1668.9	1670.7	1672.5	1674.3	1676.1	1677.9	1679.7	1681.5	1683.3	1685.1	1686.9	1688.7	1690.5	1692.3	1694.1	1695.9	1697.7	1699.5	1701.3	1703.1	1704.9	1706.7	1708.5	1710.3	1712.1	1713.9	1715.7	1717.5	1719.3	1721.1	1722.9	1724.7	1726.5	1728.3	1730.1	1731.9	1733.7	1735.5	1737.3	1739.1	1740.9	1742.7	1744.5	1746.3	1748.1	1749.9	1751.7	1753.5	1755.3	1757.1	1758.9	1760.7	1762.5	1764.3	1766.1	1767.9	1769.7	1771.5	1773.3	1775.1	1776.9	1778.7	1780.5	1782.3	1784.1	1785.9	1787.7	1789.5	1791.3	1793.1	1794.9	1796.7	1798.5	1800.3	1802.1	1803.9	1805.7	1807.5	1809.3	1811.1	1812.9	1814.7	1816.5	1818.3	1820.1	1821.9	1823.7	1825.5	1827.3	1829.1	1830.9	1832.7	1834.5	1836.3	1838.1	1839.9	1841.7	1843.5	1845.3	1847.1	1848.9	1850.7	1852.5	1854.3	1856.1	1857.9	1859.7	1861.5	1863.3	1865.1	1866.9	1868.7	1870.5	1872.3	1874.1	1875.9	1877.7	1879.5	1881.3	1883.1	1884.9	1886.7	1888.5	1890.3	1892.1	1893.9	1895.7	1897.5	1899.3	1901.1	1902.9	1904.7	1906.5	1908.3	1910.1	1911.9	1913.7	1915.5	1917.3	1919.1	1920.9	1922.7	1924.5	1926.3	1928.1	1929.9	1931.7	1933.5	1935.3	1937.1	1938.9	1940.7	1942.5	1944.3	1946.1	1947.9	1949.7	1951.5	1953.3	1955.1	1956.9	1958.7	1960.5	1962.3	1964.1	1965.9	1967.7	1969.5	1971.3	

IDB	AIRFLOW	OUTDOOR AMBIENT TEMPERATURE																								
		65				75				85				95				105				115				
		59	63	67	71	59	63	67	71	59	63	67	71	59	63	67	71	59	63	67	71	59	63	67	71	
70	1350	MBh	35.3	36.6	40.1	-	34.5	35.7	39.1	-	33.6	34.9	38.2	-	32.8	34.0	37.3	-	31.2	32.3	35.4	-	28.9	29.9	32.8	-
		S/T	0.75	0.63	0.43	-	0.78	0.65	0.45	-	0.80	0.67	0.46	-	0.82	0.69	0.48	-	0.85	0.71	0.49	-	0.86	0.72	0.50	-
		ΔT	18	16	12	-	18	16	12	-	18	16	12	-	18	16	12	-	18	16	12	-	17	15	11	-
		KW	2.25	2.29	2.37	-	2.42	2.47	2.55	-	2.57	2.62	2.71	-	2.70	2.76	2.85	-	2.82	2.88	2.97	-	2.91	2.98	3.08	-
		Amps	9.4	9.6	9.8	-	10.0	10.2	10.5	-	10.8	11.0	11.3	-	11.4	11.7	12.0	-	12.1	12.4	12.7	-	12.7	13.0	13.4	-
	1200	Hi PR	230	247	261	-	258	277	293	-	293	315	333	-	334	359	379	-	375	404	427	-	415	446	471	-
		Lo PR	112	119	130	-	118	125	137	-	123	130	142	-	129	137	150	-	135	144	157	-	140	148	162	-
		MBh	34.2	35.5	38.9	-	33.5	34.7	38.0	-	32.7	33.8	37.1	-	31.9	33.0	36.2	-	30.3	31.4	34.4	-	28.0	29.1	31.8	-
		S/T	0.72	0.60	0.41	-	0.74	0.62	0.43	-	0.76	0.63	0.44	-	0.78	0.66	0.45	-	0.81	0.68	0.47	-	0.82	0.69	0.48	-
		ΔT	19	16	12	-	19	16	12	-	19	16	12	-	19	17	13	-	19	16	12	-	18	15	12	-
1060	KW	2.23	2.28	2.35	-	2.40	2.45	2.53	-	2.55	2.60	2.69	-	2.68	2.74	2.83	-	2.79	2.85	2.95	-	2.89	2.95	3.05	-	
	Amps	9.3	9.5	9.7	-	9.9	10.1	10.4	-	10.7	10.9	11.2	-	11.3	11.6	11.9	-	12.0	12.3	12.6	-	12.6	12.9	13.3	-	
	Hi PR	227	245	258	-	255	275	290	-	290	312	330	-	330	356	376	-	372	400	422	-	411	442	467	-	
	Lo PR	111	118	128	-	117	124	136	-	121	129	141	-	127	136	148	-	134	142	155	-	138	147	160	-	
	MBh	32.5	33.7	36.9	-	31.8	32.9	36.1	-	31.0	32.2	35.2	-	30.3	31.4	34.4	-	28.8	29.8	32.7	-	26.6	27.6	30.2	-	

IDB	AIRFLOW	OUTDOOR AMBIENT TEMPERATURE																								
		65				75				85				95				105				115				
		59	63	67	71	59	63	67	71	59	63	67	71	59	63	67	71	59	63	67	71	59	63	67	71	
75	1350	MBh	35.9	36.9	40.0	42.9	35.0	36.1	39.1	41.9	34.2	35.2	38.1	40.9	33.4	34.4	37.2	39.9	31.7	32.6	35.3	37.9	29.4	30.2	32.7	35.1
		S/T	0.85	0.76	0.58	0.37	0.88	0.79	0.60	0.38	0.91	0.81	0.61	0.39	0.94	0.84	0.63	0.41	0.97	0.87	0.66	0.42	0.98	0.88	0.66	0.43
		ΔT	21	19	16	11	21	19	16	11	21	19	16	11	21	20	16	11	21	19	16	11	20	18	15	10
		KW	2.26	2.31	2.38	2.46	2.44	2.49	2.57	2.65	2.59	2.65	2.73	2.82	2.72	2.78	2.88	2.97	2.84	2.90	3.00	3.10	2.94	3.00	3.10	3.21
		Amps	9.4	9.6	9.9	10.2	10.1	10.3	10.6	11.0	10.9	11.1	11.4	11.8	11.5	11.8	12.1	12.5	12.2	12.5	12.8	13.3	12.8	13.1	13.5	14.0
	1200	Hi PR	232	250	264	275	260	280	296	309	296	319	336	351	337	363	383	400	379	408	431	450	419	451	476	497
		Lo PR	113	120	131	139	119	127	138	147	124	132	144	153	130	138	151	161	136	145	158	169	141	150	164	174
		MBh	34.8	35.9	38.8	41.7	34.0	35.0	37.9	40.7	33.2	34.2	37.0	39.7	32.4	33.4	36.1	38.8	30.8	31.7	34.3	36.8	28.5	29.4	31.8	34.1
		S/T	0.81	0.73	0.55	0.35	0.84	0.75	0.57	0.37	0.86	0.77	0.58	0.38	0.89	0.80	0.60	0.39	0.93	0.83	0.63	0.40	0.93	0.83	0.63	0.41
		ΔT	22	20	16	11	22	20	17	11	22	20	17	11	22	20	17	11	22	20	16	11	20	19	15	11
1060	KW	2.25	2.29	2.37	2.44	2.42	2.47	2.55	2.63	2.57	2.62	2.71	2.80	2.70	2.76	2.85	2.95	2.82	2.88	2.97	3.07	2.91	2.98	3.08	3.18	
	Amps	9.4	9.6	9.8	10.1	10.0	10.2	10.5	10.9	10.8	11.0	11.3	11.7	11.4	11.7	12.0	12.4	12.1	12.4	12.7	13.2	12.7	13.0	13.4	13.9	
	Hi PR	230	247	261	272	258	277	293	305	293	315	333	347	334	359	379	396	376	404	427	445	415	447	472	492	
	Lo PR	112	119	130	138	118	125	137	146	123	130	142	152	129	137	150	159	135	144	157	167	140	148	162	173	
	MBh	33.1	34.1	36.9	39.6	32.3	33.3	36.0	38.7	31.5	32.5	35.2	37.7	30.8	31.7	34.3	36.8	29.2	30.1	32.6	35.0	27.1	27.9	30.2	32.4	

IDB = Entering Indoor Dry Bulb Temperature
 High and low pressures are measured at the liquid and suction access fittings.
 Design Subcooling, 9-12 °F @ the liquid access fitting connection AHR1 95 test conditions. Design Superheat 7-11 °F @ the compressor suction access fitting connection.
 Shaded area reflects AHR1 (TVA) conditions.
 Amps: Unit amps (comp.+ evaporator + condenser fan motors)
 kW = Total system power

IDB		OUTDOOR AMBIENT TEMPERATURE												105												115															
		65						75						85						95						105						115									
		AIRFLOW		59	63	67	71	75	ENTERING INDOOR WET BULB TEMPERATURE		59	63	67	71	75	59	63	67	71	75	59	63	67	71	75	59	63	67	71	75	59	63	67	71	75						
80	MBh	36.5	37.3	39.9	42.6	35.7	36.4	38.9	41.6	34.8	35.6	38.0	40.6	34.0	34.7	37.1	39.6	32.3	33.0	35.2	37.7	29.9	30.5	32.6	34.9	32.3	33.0	35.2	37.7	29.9	30.5	32.6	34.9	32.3	33.0	35.2	37.7	29.9	30.5	32.6	34.9
	S/T	0.93	0.88	0.71	0.53	0.97	0.91	0.74	0.55	1.00	0.93	0.76	0.57	1.00	0.96	0.78	0.59	1.00	1.00	0.81	0.61	1.00	1.00	0.82	0.61	1.00	1.00	0.81	0.61	1.00	1.00	0.82	0.61	1.00	1.00	0.81	0.61	1.00	1.00	0.82	0.61
	ΔT	23	22	19	15	24	23	20	16	24	23	20	16	23	23	20	16	22	22	19	16	20	21	18	15	22	22	19	16	20	21	18	15	22	22	19	16	20	21	18	15
	KW	2.28	2.33	2.40	2.48	2.46	2.51	2.59	2.67	2.61	2.67	2.75	2.85	2.75	2.81	2.90	3.00	2.86	2.93	3.02	3.13	2.96	3.03	3.13	3.24	2.86	2.93	3.02	3.13	2.96	3.03	3.13	3.24	2.86	2.93	3.02	3.13	2.96	3.03	3.13	3.24
	Amps	9.5	9.7	10.0	10.3	10.2	10.4	10.7	11.1	11.0	11.2	11.5	11.9	11.6	11.9	12.2	12.7	12.3	12.6	13.0	13.4	13.0	13.2	13.7	14.1	12.3	12.6	13.0	13.4	13.0	13.2	13.7	14.1	12.3	12.6	13.0	13.4	13.0	13.2	13.7	14.1
	Hi PR	234	252	266	278	263	283	299	312	299	322	340	354	341	367	387	404	383	412	435	454	423	456	481	502	404	435	454	481	423	456	481	502	404	435	454	481	423	456	481	502
	Lo PR	114	121	132	141	120	128	140	149	125	133	145	155	131	140	153	162	138	146	160	170	142	151	165	176	155	162	170	176	142	151	165	176	155	162	170	176	142	151	165	176
	MBh	35.4	36.2	38.7	41.4	34.6	35.4	37.8	40.4	33.8	34.5	36.9	39.4	33.0	33.7	36.0	38.5	31.3	32.0	34.2	36.6	29.0	29.7	31.7	33.9	31.3	32.0	34.2	36.6	29.0	29.7	31.7	33.9	31.3	32.0	34.2	36.6	29.0	29.7	31.7	33.9
	S/T	0.89	0.84	0.68	0.51	0.92	0.87	0.71	0.53	0.95	0.89	0.72	0.54	0.98	0.92	0.75	0.56	1.00	0.95	0.77	0.58	1.00	0.96	0.78	0.58	0.98	0.92	0.75	0.56	1.00	0.95	0.77	0.58	0.98	0.92	0.75	0.56	1.00	0.95	0.77	0.58
	ΔT	24	23	20	16	25	23	20	16	25	24	20	16	25	24	21	16	24	24	23	20	22	22	19	15	24	23	20	16	22	22	19	15	24	23	20	16	22	22	19	15
KW	2.26	2.31	2.38	2.46	2.44	2.49	2.57	2.65	2.59	2.65	2.73	2.82	2.73	2.78	2.88	2.97	2.84	2.90	3.00	3.10	2.94	3.00	3.10	3.21	2.82	2.90	3.00	3.10	2.94	3.00	3.10	3.21	2.82	2.90	3.00	3.10	2.94	3.00	3.10	3.21	
Amps	9.4	9.6	9.9	10.2	10.1	10.3	10.6	11.0	10.9	11.1	11.4	11.8	11.5	11.8	12.1	12.5	12.2	12.5	12.8	13.3	12.8	13.1	13.5	14.0	12.2	12.5	12.8	13.3	12.8	13.1	13.5	14.0	12.2	12.5	12.8	13.3	12.8	13.1	13.5	14.0	
Hi PR	232	250	264	275	260	280	296	309	296	319	336	351	337	363	383	400	379	408	431	450	419	451	476	497	400	431	450	476	419	451	476	497	400	431	450	476	419	451	476	497	
Lo PR	113	120	131	139	119	127	138	147	124	132	144	153	130	138	151	161	136	145	158	169	141	150	164	174	153	161	169	174	141	150	164	174	136	145	158	169	141	150	164	174	
MBh	33.7	34.4	36.8	39.3	32.9	33.6	35.9	38.4	32.1	32.8	35.1	37.5	31.3	32.0	34.2	36.6	29.8	30.4	32.5	34.7	27.6	28.2	30.1	32.2	32.0	32.7	34.9	37.2	27.6	28.2	30.1	32.2	32.0	32.7	34.9	37.2	27.6	28.2	30.1	32.2	
S/T	0.85	0.80	0.65	0.49	0.89	0.83	0.68	0.51	0.91	0.85	0.69	0.52	0.94	0.88	0.72	0.53	0.97	0.91	0.74	0.55	0.98	0.92	0.75	0.56	0.94	0.88	0.72	0.53	0.97	0.91	0.74	0.55	0.94	0.88	0.72	0.53	0.97	0.91	0.74	0.55	
ΔT	25	24	21	17	25	24	21	17	25	24	21	17	25	24	21	17	25	24	21	17	23	22	20	16	24	23	20	16	23	22	20	16	24	23	20	16	23	22	20	16	
KW	2.23	2.28	2.35	2.42	2.40	2.45	2.53	2.61	2.55	2.60	2.69	2.78	2.68	2.74	2.83	2.92	2.79	2.85	2.95	3.05	2.89	2.95	3.05	3.15	2.83	2.92	3.02	3.12	2.89	2.95	3.05	3.15	2.83	2.92	3.02	3.12	2.89	2.95	3.05	3.15	
Amps	9.3	9.5	9.7	10.1	9.5	10.1	10.4	10.8	10.7	10.9	11.2	11.6	11.3	11.6	11.9	12.3	12.0	12.3	12.6	13.1	12.6	12.9	13.3	13.8	12.3	12.6	13.1	13.8	12.6	12.9	13.3	13.8	12.3	12.6	13.1	13.8	12.6	12.9	13.3	13.8	
Hi PR	227	245	258	269	255	275	290	302	290	312	330	344	330	356	376	392	372	400	422	441	411	442	467	487	344	376	392	441	411	442	467	487	372	400	422	441	411	442	467	487	
Lo PR	111	118	128	137	117	124	136	144	121	129	141	150	127	136	148	158	134	142	155	165	138	147	160	171	150	158	165	171	138	147	160	171	134	142	155	165	138	147	160	171	

IDB		OUTDOOR AMBIENT TEMPERATURE												105												115															
		65						75						85						95						105						115									
		AIRFLOW		59	63	67	71	75	ENTERING INDOOR WET BULB TEMPERATURE		59	63	67	71	75	59	63	67	71	75	59	63	67	71	75	59	63	67	71	75	59	63	67	71	75						
85	MBh	37.2	37.9	39.7	42.3	36.3	37.0	38.7	41.3	35.4	36.1	37.8	40.3	34.6	35.2	36.9	39.4	32.8	33.5	35.0	37.4	30.4	31.0	32.5	34.6	34.6	35.2	36.9	39.4	32.8	33.5	35.0	37.4	34.6	35.2	36.9	39.4	32.8	33.5	35.0	37.4
	S/T	0.98	0.95	0.85	0.69	1.00	0.98	0.88	0.72	1.00	0.96	0.87	0.70	1.00	1.00	0.94	0.76	1.00	1.00	0.97	0.79	1.00	1.00	0.98	0.80	1.00	1.00	0.94	0.76	1.00	1.00	0.97	0.79	1.00	1.00	0.97	0.79	1.00	1.00	0.98	0.80
	ΔT	25	24	23	20	25	25	23	20	24	25	23	20	24	24	24	20	24	23	23	20	21	21	22	19	24	24	24	20	22	23	23	20	24	25	24	21	23	23	23	20
	KW	2.30	2.35	2.42	2.50	2.48	2.53	2.61	2.70	2.63	2.69	2.78	2.87	2.77	2.83	2.92	3.02	2.89	2.95	3.05	3.15	2.99	3.05	3.16	3.26	2.87	2.92	3.02	3.12	2.89	2.95	3.05	3.15	2.87	2.92	3.02	3.12	2.89	2.95	3.05	3.16
	Amps	9.6	9.8	10.1	10.4	10.3	10.5	10.8	11.1	11.0	11.3	11.6	12.0	11.7	12.0	12.3	12.8	12.4	12.7	13.1	13.5	13.1	13.4	13.8	14.3	12.3	12.6	13.0	13.4	13.1	13.4	13.8	14.3	12.3	12.6	13.0	13.4	13.1	13.4	13.8	14.3
	Hi PR	237	255	269	281	266	286	302	315	302	325	343	358	344	370	391	408	387	416	440	459	428	460	486	507	408	439	459	486	428	460	486	507	408	439	459	486	428	460	486	507
	Lo PR	115	122	134	142	122	129	141	150	126	134	147	156	133	141	154	164	139	148	161	172	144	153	167	178	156	164	172	178	144	153	167	178	139	148	161	172	144	153	167	178
	MBh	36.1	36.8	38.5	41.1	35.2	35.9	37.6	40.1	34.4	35.1	36.7	39.2	33.6	34.2	35.8	38.2	31.9	32.5	34.0	36.3	29.5	30.1	31.5	33.6	33.6	34.2	35.8	38.2	31.9	32.5	34.0	36.3	33.6	34.2	35.8	38.2	31.9	32.5	34.0	36.3
	S/T	0.93	0.90	0.81	0.66	0.97	0.93	0.84	0.68	0.99	0.96	0.87	0.70	1.00	0.99	0.89	0.72	1.00	1.00	0.93	0.75	1.00	1.00	0.93	0.76	0.99	0.96	0.87	0.70	1.00	1.00	0.93	0.75	0.99	0.96	0.87	0.70	1.00	1.00	0.93	0.76
	ΔT	26	25	24	21	26	26	24	21	26	26	24	21	26	26	25	21	24	25	24	21	23	23	23	20	26	26	25	21	24	25	24	21	26	26	25	21	24	25	24	21
KW	2.28	2.33	2.40	2.48	2.46	2.51	2.59	2.67	2.61	2.67	2.75	2.85	2.75	2.81	2.90	3.00	2.86	2.93	3.02	3.13	2.96	3.03	3.13	3.24	2.85	2.90	3.00	3.10	2.86	2.93	3.02	3.13	2.85	2.90	3.00	3.10	2.86	2.93	3.02	3.13	
Amps	9.5	9.7	10.0	10.3	10.2																																				

IDB	AIRFLOW	OUTDOOR AMBIENT TEMPERATURE																								
		65				75				85				95				105				115				
		59	63	67	71	59	63	67	71	59	63	67	71	59	63	67	71	59	63	67	71	59	63	67	71	
70	1350	MBh	34.9	36.2	39.6	-	34.1	35.3	38.7	-	33.3	34.5	37.8	-	32.5	33.6	36.9	-	30.8	32.0	35.0	-	28.6	29.6	32.4	-
		S/T	0.77	0.65	0.45	-	0.80	0.67	0.46	-	0.82	0.69	0.48	-	0.85	0.71	0.49	-	0.88	0.74	0.51	-	0.89	0.74	0.51	-
		ΔT	18	16	12	-	19	16	12	-	19	16	12	-	19	16	12	-	18	16	12	-	17	15	11	-
		KW	2.07	2.12	2.18	-	2.23	2.28	2.35	-	2.37	2.42	2.50	-	2.49	2.55	2.63	-	2.60	2.65	2.74	-	2.69	2.75	2.84	-
		Amps	9.2	9.3	9.6	-	9.8	10.0	10.3	-	10.6	10.8	11.1	-	11.2	11.5	11.8	-	11.9	12.2	12.5	-	12.5	12.8	13.2	-
	1200	Hi PR	224	241	254	-	251	270	285	-	285	307	324	-	325	350	369	-	366	393	415	-	404	435	459	-
		Lo PR	114	121	132	-	120	128	140	-	125	133	145	-	131	140	152	-	138	146	160	-	142	151	165	-
		MBh	33.9	35.1	38.5	-	33.1	34.3	37.6	-	32.3	33.5	36.7	-	31.5	32.7	35.8	-	29.9	31.0	34.0	-	27.7	28.7	31.5	-
		S/T	0.74	0.62	0.43	-	0.76	0.64	0.44	-	0.78	0.65	0.45	-	0.81	0.68	0.47	-	0.84	0.70	0.49	-	0.85	0.71	0.49	-
		ΔT	19	17	13	-	19	17	13	-	19	17	13	-	20	17	13	-	19	17	13	-	18	16	12	-
1060	KW	2.06	2.10	2.16	-	2.21	2.26	2.33	-	2.35	2.40	2.48	-	2.47	2.53	2.61	-	2.57	2.63	2.72	-	2.66	2.72	2.81	-	
	Amps	9.1	9.3	9.5	-	9.7	9.9	10.2	-	10.5	10.7	11.0	-	11.1	11.4	11.7	-	11.8	12.1	12.4	-	12.4	12.7	13.1	-	
	Hi PR	221	238	251	-	248	267	282	-	282	304	321	-	322	346	366	-	362	389	411	-	400	430	454	-	
	Lo PR	113	120	131	-	119	127	138	-	124	132	144	-	130	138	151	-	136	145	158	-	141	150	164	-	
	MBh	32.2	33.3	36.5	-	31.4	32.6	35.7	-	30.7	31.8	34.8	-	29.9	31.0	34.0	-	28.4	29.5	32.3	-	26.3	27.3	29.9	-	

IDB	AIRFLOW	OUTDOOR AMBIENT TEMPERATURE																								
		65				75				85				95				105				115				
		59	63	67	71	59	63	67	71	59	63	67	71	59	63	67	71	59	63	67	71	59	63	67	71	
75	1350	MBh	35.5	36.5	39.5	42.4	34.7	35.7	38.6	41.4	33.8	34.8	37.7	40.5	33.0	34.0	36.8	39.5	31.4	32.3	34.9	37.5	29.0	29.9	32.4	34.7
		S/T	0.88	0.79	0.60	0.38	0.91	0.81	0.62	0.40	0.93	0.84	0.63	0.41	0.96	0.86	0.65	0.42	1.00	0.90	0.68	0.44	1.00	0.90	0.68	0.44
		ΔT	21	20	16	11	21	20	16	11	22	20	16	11	22	20	16	11	21	20	16	11	20	18	15	10
		KW	2.09	2.13	2.20	2.27	2.25	2.30	2.37	2.45	2.39	2.44	2.52	2.60	2.51	2.57	2.65	2.74	2.62	2.68	2.76	2.86	2.71	2.77	2.86	2.96
		Amps	9.2	9.4	9.7	10.0	9.9	10.1	10.4	10.8	10.7	10.9	11.2	11.6	11.3	11.6	11.9	12.3	12.0	12.3	12.6	13.1	12.6	12.9	13.3	13.8
	1200	Hi PR	226	243	257	268	253	273	288	300	288	310	327	342	328	353	373	389	369	397	420	438	408	439	464	484
		Lo PR	115	122	134	142	121	129	141	150	126	134	147	156	133	141	154	164	139	148	161	172	144	153	167	178
		MBh	34.4	35.5	38.4	41.2	33.6	34.6	37.5	40.2	32.8	33.8	36.6	39.3	32.0	33.0	35.7	38.3	30.4	31.3	33.9	36.4	28.2	29.0	31.4	33.7
		S/T	0.84	0.75	0.57	0.37	0.87	0.78	0.59	0.38	0.89	0.80	0.60	0.39	0.92	0.82	0.62	0.40	0.95	0.85	0.65	0.42	0.96	0.86	0.65	0.42
		ΔT	22	20	17	12	22	21	17	12	22	21	17	12	23	21	17	12	22	21	17	12	21	19	16	11
1060	KW	2.07	2.12	2.18	2.25	2.23	2.28	2.35	2.43	2.37	2.42	2.50	2.58	2.49	2.55	2.63	2.72	2.60	2.65	2.74	2.83	2.69	2.75	2.84	2.93	
	Amps	9.2	9.3	9.6	9.9	9.8	10.0	10.3	10.7	10.6	10.8	11.1	11.5	11.2	11.5	11.8	12.2	11.9	12.2	12.5	13.0	12.5	12.8	13.2	13.7	
	Hi PR	224	241	254	265	251	270	285	297	285	307	324	338	325	350	369	385	366	393	415	433	404	435	459	479	
	Lo PR	114	121	132	141	120	128	140	149	125	133	145	155	131	140	152	162	138	146	160	170	142	151	165	176	
	MBh	32.7	33.7	36.5	39.1	32.0	32.9	35.6	38.2	31.2	32.1	34.8	37.3	30.4	31.3	33.9	36.4	28.9	29.8	32.2	34.6	26.8	27.6	29.9	32.0	

IDB = Entering Indoor Dry Bulb Temperature
 High and low pressures are measured at the liquid and suction access fittings.
 Design Subcooling, 9-12 °F @ the liquid access fitting connection AHR1 95 test conditions. Design Superheat 7-11 °F @ the compressor suction access fitting connection.
 Shaded area reflects AHR1 (TVA) conditions.
 Amps: Unit amps (comp.+ evaporator + condenser fan motors)
 KW = Total system power

IDB		OUTDOOR AMBIENT TEMPERATURE												ENTERING INDOOR WET BULB TEMPERATURE											
		65				75				85				95				105				115			
		59	63	67	71	59	63	67	71	59	63	67	71	59	63	67	71	59	63	67	71	59	63	67	71
1350	Mb/h	36.1	36.9	39.4	42.1	35.3	36.0	38.5	41.2	34.4	35.2	37.6	40.2	33.6	34.3	36.7	39.2	31.9	32.6	34.8	37.2	29.6	30.2	32.3	34.5
	S/T	0.96	0.90	0.74	0.55	1.00	0.94	0.76	0.57	1.00	0.96	0.78	0.58	1.00	1.00	0.81	0.60	1.00	1.00	0.84	0.63	1.00	1.00	0.84	0.63
	ΔT	24	23	20	16	24	23	20	16	23	23	20	16	23	23	20	16	22	22	20	16	20	21	19	15
	kW	2.10	2.15	2.22	2.29	2.27	2.31	2.39	2.47	2.41	2.46	2.54	2.62	2.53	2.59	2.67	2.76	2.64	2.70	2.79	2.88	2.73	2.79	2.89	2.98
	Amps	9.3	9.5	9.8	10.1	10.0	10.2	10.5	10.8	10.7	11.0	11.3	11.7	11.4	11.7	12.0	12.4	12.1	12.4	12.7	13.2	12.8	13.0	13.4	13.9
	Hi PR	228	245	259	270	256	275	291	303	291	313	331	345	332	357	377	393	373	401	424	442	412	443	468	488
	Lo PR	116	124	135	144	123	131	142	152	127	136	148	158	134	142	156	166	140	149	163	174	145	154	169	180
	Mb/h	35.1	35.8	38.3	40.9	34.2	35.0	37.4	40.0	33.4	34.2	36.5	39.0	32.6	33.3	35.6	38.1	31.0	31.7	33.8	36.2	28.7	29.3	31.3	33.5
	S/T	0.92	0.86	0.70	0.52	0.95	0.89	0.73	0.54	0.98	0.92	0.75	0.56	1.00	0.95	0.77	0.58	1.00	0.98	0.80	0.60	1.00	0.99	0.81	0.60
	ΔT	25	24	21	16	25	24	21	17	25	24	21	17	25	24	21	17	24	24	21	17	22	22	19	15
kW	2.09	2.13	2.20	2.27	2.25	2.30	2.37	2.45	2.39	2.44	2.52	2.60	2.51	2.57	2.65	2.74	2.62	2.68	2.76	2.86	2.71	2.77	2.86	2.96	
Amps	9.2	9.4	9.7	10.0	9.9	10.1	10.4	10.8	10.7	10.9	11.2	11.6	11.3	11.6	11.9	12.3	12.0	12.3	12.6	13.1	12.6	12.9	13.3	13.8	
Hi PR	226	243	257	268	253	273	288	300	288	310	327	342	328	353	373	389	369	397	420	438	408	439	464	484	
Lo PR	115	122	134	142	121	129	141	150	126	134	147	156	133	141	154	164	139	148	161	172	144	153	167	178	
Mb/h	33.3	34.0	36.4	38.9	32.5	33.2	35.5	38.0	31.8	32.4	34.7	37.1	31.0	31.7	33.8	36.2	29.4	30.1	32.1	34.3	27.3	27.9	29.8	31.8	
S/T	0.88	0.83	0.67	0.50	0.91	0.86	0.70	0.52	0.94	0.88	0.71	0.53	0.97	0.91	0.74	0.55	1.00	0.94	0.77	0.57	1.01	0.95	0.77	0.58	
ΔT	25	24	21	17	26	25	21	17	26	25	21	17	26	25	22	17	26	25	21	17	24	23	20	16	
kW	2.06	2.10	2.16	2.23	2.21	2.26	2.33	2.41	2.35	2.40	2.48	2.56	2.47	2.53	2.61	2.69	2.57	2.63	2.72	2.81	2.66	2.72	2.81	2.91	
Amps	9.1	9.3	9.5	9.9	9.7	9.9	10.2	10.6	10.5	10.7	11.0	11.4	11.1	11.4	11.7	12.1	11.8	12.1	12.4	12.9	12.4	12.7	13.1	13.6	
Hi PR	221	238	251	262	248	267	282	294	282	304	321	335	322	346	366	381	362	389	411	429	400	430	454	474	
Lo PR	113	120	131	139	119	127	138	147	124	132	144	153	130	138	151	161	136	145	158	168	141	150	164	174	
Mb/h	36.7	37.4	39.2	41.8	35.9	36.6	38.3	40.9	35.0	35.7	37.4	39.9	34.2	34.8	36.5	38.9	32.5	33.1	34.7	37.0	30.1	30.7	32.1	34.3	
S/T	1.00	0.98	0.88	0.71	1.00	1.00	0.91	0.74	1.00	1.00	0.94	0.76	1.00	1.00	0.97	0.78	1.00	1.00	0.96	0.81	1.00	1.00	0.96	0.82	
ΔT	25	25	24	20	24	25	24	21	24	24	24	21	23	24	24	21	22	23	24	20	20	21	22	19	
kW	2.12	2.17	2.23	2.31	2.28	2.33	2.41	2.49	2.43	2.48	2.56	2.65	2.55	2.61	2.70	2.79	2.66	2.72	2.81	2.91	2.76	2.82	2.91	3.01	
Amps	9.4	9.6	9.9	10.2	10.1	10.3	10.6	10.9	10.8	11.1	11.4	11.8	11.5	11.8	12.1	12.6	12.2	12.5	12.9	13.3	12.9	13.2	13.6	14.0	
Hi PR	230	248	262	273	258	278	294	306	294	316	334	348	335	360	380	397	377	405	428	446	416	448	473	493	
Lo PR	117	125	136	145	124	132	144	153	129	137	150	159	135	144	157	167	142	151	165	175	147	156	170	181	
Mb/h	35.7	36.4	38.1	40.6	34.8	35.5	37.2	39.7	34.0	34.7	36.3	38.7	33.2	33.8	35.4	37.8	31.5	32.1	33.7	35.9	29.2	29.8	31.2	33.3	
S/T	0.96	0.93	0.84	0.68	1.00	0.96	0.87	0.71	1.00	0.99	0.89	0.72	1.00	1.00	0.92	0.75	1.00	1.00	0.96	0.78	1.00	1.00	0.96	0.78	
ΔT	26	26	24	21	27	26	25	21	26	26	25	21	25	26	25	22	24	25	25	21	22	23	23	20	
kW	2.10	2.15	2.22	2.29	2.27	2.31	2.39	2.47	2.41	2.46	2.54	2.62	2.53	2.59	2.67	2.76	2.64	2.70	2.79	2.88	2.73	2.79	2.89	2.98	
Amps	9.3	9.5	9.8	10.1	10.0	10.2	10.5	10.8	10.7	11.0	11.3	11.7	11.4	11.7	12.0	12.4	12.1	12.4	12.7	13.2	12.8	13.0	13.4	13.9	
Hi PR	228	245	259	270	256	275	291	303	291	313	331	345	332	357	377	393	373	401	424	442	412	443	468	488	
Lo PR	116	124	135	144	123	131	142	152	127	136	148	158	134	142	156	166	140	149	163	174	145	154	169	180	
Mb/h	33.9	34.5	36.2	38.6	33.1	33.7	35.3	37.7	32.3	32.9	34.5	36.8	31.5	32.1	33.7	35.9	29.9	30.5	32.0	34.1	27.7	28.3	29.6	31.6	
S/T	0.92	0.89	0.80	0.65	0.96	0.92	0.83	0.68	0.98	0.95	0.85	0.69	1.00	0.98	0.88	0.72	1.00	1.00	0.92	0.74	1.00	1.00	0.92	0.75	
ΔT	27	27	25	22	27	27	26	22	27	27	26	22	27	27	26	22	26	26	25	22	24	25	24	21	
kW	2.07	2.12	2.18	2.25	2.23	2.28	2.35	2.43	2.37	2.42	2.50	2.58	2.49	2.55	2.63	2.72	2.60	2.65	2.74	2.83	2.69	2.75	2.84	2.93	
Amps	9.2	9.3	9.6	9.9	9.8	10.0	10.3	10.7	10.6	10.8	11.1	11.5	11.2	11.5	11.8	12.2	11.9	12.2	12.5	13.0	12.5	12.8	13.2	13.7	
Hi PR	224	241	254	265	251	270	285	297	285	307	324	338	325	350	369	385	366	393	415	433	404	435	459	479	
Lo PR	114	121	132	141	120	128	140	149	125	133	145	155	131	140	152	162	138	146	160	170	142	151	165	176	

IDB = Entering Indoor Dry Bulb Temperature

High and low pressures are measured at the liquid and suction access fittings.

Design Subcooling, 9-12 °F @ the liquid access fitting connection AHRJ 95 test conditions. Design Superheat 7-11°F @ the compressor suction access fitting connection.

Shaded area reflects AHRJ conditions.

Amps: Unit amps (comp.+ evaporator + condenser fan motors)

kW = Total system power

IDB	AIRFLOW	OUTDOOR AMBIENT TEMPERATURE																							
		65				75				85				95				105				115			
		59	63	67	71	59	63	67	71	59	63	67	71	59	63	67	71	59	63	67	71	59	63	67	71
70	MBh	39.7	41.1	45.1	-	38.8	40.2	44.0	-	37.8	39.2	43.0	-	36.9	38.3	41.9	-	35.1	36.4	39.8	-	32.5	33.7	36.9	-
	S/T	0.74	0.62	0.43	-	0.77	0.64	0.44	-	0.79	0.66	0.46	-	0.81	0.68	0.47	-	0.84	0.70	0.49	-	0.85	0.71	0.49	-
	ΔT	19	16	12	-	19	16	12	-	19	16	12	-	19	16	12	-	19	16	12	-	17	15	11	-
	KW	2.58	2.63	2.72	-	2.78	2.84	2.93	-	2.95	3.02	3.11	-	3.11	3.17	3.28	-	3.24	3.31	3.42	-	3.35	3.43	3.54	-
	Amps	11.0	11.2	11.6	-	11.8	12.1	12.4	-	12.7	13.0	13.4	-	13.5	13.8	14.2	-	14.3	14.6	15.1	-	15.1	15.4	15.9	-
	Hi PR	236	254	268	-	265	285	301	-	301	324	342	-	343	369	390	-	386	415	438	-	426	459	484	-
	Lo PR	111	118	128	-	118	125	136	-	122	130	142	-	128	136	149	-	134	143	156	-	139	148	162	-
	MBh	38.5	39.9	43.8	-	37.6	39.0	42.7	-	36.7	38.1	41.7	-	35.8	37.1	40.7	-	34.1	35.3	38.7	-	31.5	32.7	35.8	-
	S/T	0.71	0.59	0.41	-	0.73	0.61	0.42	-	0.75	0.63	0.43	-	0.77	0.65	0.45	-	0.80	0.67	0.47	-	0.81	0.68	0.47	-
	ΔT	19	17	13	-	19	17	13	-	20	17	13	-	20	17	13	-	19	17	13	-	18	16	12	-
KW	2.56	2.61	2.69	-	2.75	2.81	2.90	-	2.93	2.99	3.09	-	3.08	3.15	3.25	-	3.21	3.28	3.39	-	3.32	3.40	3.51	-	
Amps	10.9	11.2	11.5	-	11.7	12.0	12.3	-	12.6	12.9	13.3	-	13.4	13.7	14.1	-	14.2	14.5	14.9	-	14.9	15.3	15.8	-	
Hi PR	234	251	265	-	262	282	298	-	298	321	339	-	339	365	386	-	382	411	434	-	422	454	479	-	
Lo PR	110	117	128	-	116	124	135	-	121	129	140	-	127	135	148	-	133	142	155	-	138	146	160	-	
MBh	36.6	37.9	41.6	-	35.8	37.1	40.6	-	34.9	36.2	39.6	-	34.1	35.3	38.7	-	32.3	33.5	36.7	-	30.0	31.1	34.0	-	
S/T	0.68	0.57	0.39	-	0.70	0.59	0.41	-	0.72	0.60	0.42	-	0.74	0.62	0.43	-	0.77	0.64	0.45	-	0.78	0.65	0.45	-	
ΔT	20	17	13	-	20	17	13	-	20	17	13	-	20	17	13	-	20	17	13	-	19	16	12	-	
KW	2.52	2.57	2.65	-	2.71	2.77	2.86	-	2.88	2.94	3.04	-	3.03	3.10	3.20	-	3.16	3.23	3.33	-	3.27	3.34	3.45	-	
Amps	10.8	11.0	11.3	-	11.5	11.8	12.1	-	12.4	12.7	13.1	-	13.2	13.5	13.9	-	13.9	14.2	14.7	-	14.7	15.0	15.5	-	
Hi PR	229	246	260	-	257	276	292	-	292	314	332	-	333	358	378	-	374	403	425	-	413	445	470	-	
Lo PR	108	115	125	-	114	121	132	-	119	126	138	-	124	132	145	-	130	139	152	-	135	144	157	-	

75	MBh	40.4	41.6	45.0	48.3	39.4	40.6	43.9	47.2	38.5	39.6	42.9	46.0	37.5	38.7	41.8	44.9	35.7	36.7	39.7	42.7	33.0	34.0	36.8	39.5
	S/T	0.84	0.75	0.57	0.37	0.87	0.78	0.59	0.38	0.89	0.80	0.61	0.39	0.92	0.83	0.83	0.63	0.96	0.86	0.65	0.42	0.97	0.86	0.65	0.42
	ΔT	21	20	16	11	22	20	16	11	22	20	16	11	22	20	16	11	22	20	16	11	20	19	15	10
	KW	2.60	2.65	2.74	2.83	2.80	2.86	2.95	3.05	2.98	3.04	3.14	3.24	3.13	3.20	3.31	3.42	3.26	3.34	3.45	3.56	3.38	3.45	3.57	3.69
	Amps	11.1	11.3	11.7	12.1	11.9	12.2	12.5	12.9	12.8	13.1	13.5	14.0	13.6	13.9	14.3	14.8	14.4	14.7	15.2	15.7	15.2	15.5	16.0	16.6
	Hi PR	238	256	271	282	267	288	304	317	304	327	346	360	346	373	394	410	390	419	443	462	430	463	489	510
	Lo PR	112	120	131	139	119	126	138	147	123	131	143	153	130	138	151	160	136	145	158	168	140	149	163	174
	MBh	39.2	40.3	43.7	46.9	38.3	39.4	42.7	45.8	37.4	38.5	41.6	44.7	36.5	37.5	40.6	43.6	34.6	35.7	38.6	41.4	32.1	33.0	35.7	38.4
	S/T	0.80	0.72	0.54	0.35	0.83	0.74	0.56	0.36	0.85	0.76	0.58	0.37	0.88	0.79	0.60	0.38	0.91	0.82	0.62	0.40	0.92	0.82	0.62	0.40
	ΔT	22	20	17	12	23	21	17	12	23	21	17	12	23	21	17	12	22	21	17	12	21	19	16	11
KW	2.58	2.63	2.72	2.80	2.78	2.84	2.93	3.02	2.95	3.02	3.11	3.22	3.11	3.18	3.28	3.39	3.24	3.31	3.42	3.53	3.35	3.43	3.54	3.66	
Amps	11.0	11.2	11.6	12.0	11.8	12.1	12.4	12.8	12.7	13.0	13.4	13.8	13.5	13.8	14.2	14.7	14.3	14.6	15.1	15.6	15.1	15.4	15.9	16.5	
Hi PR	236	254	268	280	265	285	301	314	301	324	342	357	343	369	390	406	386	415	438	457	426	459	484	505	
Lo PR	111	118	129	138	118	125	137	145	122	130	142	151	128	137	149	159	134	143	156	166	139	148	162	172	
MBh	37.2	38.3	41.5	44.5	36.4	37.4	40.5	43.5	35.5	36.5	39.6	42.5	34.6	35.7	38.6	41.4	32.9	33.9	36.7	39.3	30.5	31.4	34.0	36.4	
S/T	0.77	0.69	0.52	0.33	0.80	0.71	0.54	0.35	0.82	0.73	0.55	0.36	0.84	0.75	0.57	0.37	0.88	0.78	0.59	0.38	0.88	0.79	0.60	0.38	
ΔT	23	21	17	12	23	21	17	12	23	21	17	12	23	22	18	12	23	21	17	12	22	20	16	11	
KW	2.54	2.59	2.67	2.76	2.73	2.79	2.88	2.97	2.90	2.97	3.06	3.16	3.06	3.12	3.22	3.33	3.18	3.25	3.36	3.47	3.29	3.37	3.48	3.60	
Amps	10.8	11.1	11.4	11.8	11.6	11.9	12.2	12.6	12.5	12.8	13.2	13.6	13.3	13.6	14.0	14.5	14.1	14.4	14.8	15.3	14.8	15.1	15.6	16.2	
Hi PR	231	249	263	274	259	279	295	307	295	317	335	350	336	362	382	398	378	407	430	448	418	449	475	495	
Lo PR	109	116	127	135	115	123	134	142	120	127	139	148	126	134	146	156	132	140	153	163	136	145	158	169	

IDB = Entering Indoor Dry Bulb Temperature
 High and low pressures are measured at the liquid and suction access fittings.
 Design Subcooling, 8-12 °F @ the liquid access fitting connection AHR195 test conditions. Design Superheat 8-12°F @ the compressor suction access fitting connection.
 Shaded area reflects AHR1 (TV) conditions.
 Amps: Unit amps (comp.+ evaporator + condenser fan motors)
 KW = Total system power

IDB		OUTDOOR AMBIENT TEMPERATURE												ENTERING INDOOR WET BULB TEMPERATURE											
		65				75				85				95				105				115			
		59	63	67	71	59	63	67	71	59	63	67	71	59	63	67	71	59	63	67	71	59	63	67	71
80	AIRFLOW	59	63	67	71	59	63	67	71	59	63	67	71	59	63	67	71	59	63	67	71	59	63	67	71
	Mbh	41.1	42.0	44.8	47.9	40.1	41.0	43.8	46.8	39.2	40.0	42.8	45.7	38.2	39.0	41.7	44.6	36.3	37.1	39.6	42.4	33.6	34.4	36.7	39.2
	S/T	0.92	0.87	0.70	0.53	0.96	0.90	0.73	0.55	1.00	0.92	0.75	0.56	1.00	0.95	0.77	0.58	1.00	1.00	0.80	0.60	1.00	1.00	0.81	0.60
	ΔT	24	23	20	16	24	23	20	16	25	23	20	16	24	23	20	16	23	23	20	16	21	22	19	15
	KW	2.62	2.68	2.76	2.85	2.82	2.88	2.98	3.07	3.00	3.07	3.17	3.27	3.16	3.23	3.33	3.45	3.29	3.37	3.48	3.60	3.41	3.48	3.60	3.72
	Amps	11.2	11.4	11.8	12.2	12.0	12.3	12.6	13.0	12.9	13.2	13.6	14.1	13.7	14.0	14.5	15.0	14.5	14.9	15.3	15.9	15.3	15.7	16.2	16.7
	Hi PR	241	259	273	285	270	291	307	320	307	330	349	364	350	376	397	415	394	423	447	466	435	468	494	515
	Lo PR	114	121	132	140	120	128	139	148	125	133	145	154	131	139	152	162	137	146	159	170	142	151	165	176
	Mbh	39.9	40.8	43.5	46.5	39.0	39.8	42.5	45.5	38.0	38.9	41.5	44.4	37.1	37.9	40.5	43.3	35.2	36.0	38.5	41.1	32.6	33.4	35.6	38.1
	S/T	0.88	0.83	0.67	0.50	0.91	0.86	0.70	0.52	0.94	0.88	0.71	0.53	0.97	0.91	0.74	0.55	1.00	0.94	0.77	0.57	1.00	0.95	0.77	0.58
ΔT	25	24	21	17	25	24	21	17	25	24	21	17	25	24	21	17	25	24	21	17	23	22	19	16	
KW	2.60	2.66	2.74	2.83	2.80	2.86	2.95	3.05	2.98	3.04	3.14	3.24	3.13	3.20	3.31	3.42	3.26	3.34	3.45	3.56	3.38	3.45	3.57	3.69	
Amps	11.1	11.3	11.7	12.1	11.9	12.2	12.5	12.9	12.8	13.1	13.5	14.0	13.6	13.9	14.3	14.8	14.4	14.7	15.2	15.7	15.2	15.5	16.0	16.6	
Hi PR	238	256	271	282	267	288	304	317	304	327	346	360	346	373	394	410	430	419	443	462	490	463	489	510	
Lo PR	112	120	131	139	119	126	138	147	123	131	143	153	130	138	151	160	136	145	158	168	141	149	163	174	
Mbh	37.9	38.7	41.4	44.2	37.0	37.8	40.4	43.2	36.1	36.9	39.4	42.2	35.2	36.0	38.5	41.1	33.5	34.2	36.6	39.1	31.0	31.7	33.9	36.2	
S/T	0.84	0.79	0.64	0.48	0.87	0.82	0.67	0.50	0.90	0.84	0.68	0.51	0.93	0.87	0.71	0.53	0.96	0.90	0.73	0.55	0.97	0.91	0.74	0.55	
ΔT	26	24	21	17	26	25	22	17	26	25	22	17	26	25	22	17	26	25	21	17	24	23	20	16	
KW	2.56	2.61	2.69	2.78	2.75	2.81	2.90	3.00	2.93	2.99	3.09	3.19	3.08	3.15	3.25	3.36	3.21	3.28	3.39	3.50	3.32	3.40	3.51	3.63	
Amps	10.9	11.2	11.5	11.9	11.7	12.0	12.3	12.7	12.6	12.9	13.3	13.7	13.4	13.7	14.1	14.6	14.2	14.5	14.9	15.5	14.9	15.3	15.8	16.3	
Hi PR	234	251	265	277	262	282	298	311	298	321	339	353	339	365	386	402	382	411	434	453	422	454	479	500	
Lo PR	110	117	128	136	116	124	135	144	121	129	140	150	127	135	148	157	133	142	155	165	138	146	160	170	
Mbh	41.8	42.6	44.6	47.6	40.8	41.6	43.6	46.5	39.9	40.6	42.5	45.4	38.9	39.6	41.5	44.3	36.9	37.6	39.4	42.1	34.2	34.9	36.5	39.0	
S/T	0.97	0.93	0.84	0.68	1.00	0.97	0.87	0.71	1.00	0.99	0.90	0.73	1.00	1.00	0.92	0.75	1.00	1.00	0.96	0.78	1.00	1.00	0.97	0.79	
ΔT	25	25	24	21	26	25	24	21	25	25	24	21	24	25	24	21	23	24	24	21	22	22	22	19	
KW	2.64	2.70	2.78	2.87	2.85	2.91	3.00	3.10	3.03	3.09	3.19	3.30	3.18	3.26	3.36	3.48	3.32	3.39	3.51	3.63	3.44	3.51	3.63	3.76	
Amps	11.3	11.5	11.9	12.3	12.1	12.4	12.7	13.2	13.0	13.3	13.7	14.2	13.8	14.2	14.6	15.1	14.7	15.0	15.5	16.0	15.5	15.8	16.3	16.9	
Hi PR	243	262	276	288	273	294	310	323	310	334	352	368	353	380	401	419	397	428	452	471	439	473	499	520	
Lo PR	115	122	133	142	121	129	141	150	126	134	146	156	132	141	154	164	139	147	161	171	143	152	166	177	
Mbh	40.6	41.4	43.3	46.2	39.6	40.4	42.3	45.1	38.7	39.4	41.3	44.1	37.7	38.5	40.3	43.0	35.9	36.6	38.3	40.8	33.2	33.9	35.5	37.8	
S/T	0.92	0.89	0.80	0.65	0.96	0.92	0.83	0.68	0.98	0.95	0.85	0.69	1.00	0.98	0.88	0.72	1.00	1.00	0.92	0.74	1.00	1.00	0.92	0.75	
ΔT	26	26	25	21	27	26	25	22	27	26	25	22	27	27	25	22	25	26	25	21	23	24	23	20	
KW	2.62	2.68	2.76	2.85	2.82	2.88	2.98	3.07	3.00	3.07	3.17	3.27	3.16	3.23	3.33	3.45	3.29	3.37	3.48	3.60	3.41	3.48	3.60	3.72	
Amps	11.2	11.4	11.8	12.2	12.0	12.3	12.6	13.0	12.9	13.2	13.6	14.1	13.7	14.0	14.5	15.0	14.5	14.9	15.3	15.9	15.3	15.7	16.2	16.7	
Hi PR	241	259	273	285	270	291	307	320	307	330	349	364	350	376	397	415	394	423	447	466	435	468	494	515	
Lo PR	114	121	132	140	120	128	139	148	125	133	145	154	131	139	152	162	137	146	159	170	142	151	165	176	
Mbh	38.5	39.3	41.2	43.9	37.7	38.4	40.2	42.9	36.8	37.5	39.2	41.9	35.9	36.6	38.3	40.8	34.1	34.7	36.4	38.8	31.6	32.2	33.7	35.9	
S/T	0.88	0.85	0.77	0.62	0.92	0.88	0.80	0.65	0.94	0.91	0.82	0.66	0.97	0.94	0.84	0.69	1.00	0.97	0.88	0.71	1.00	0.98	0.88	0.72	
ΔT	27	27	25	22	28	27	26	22	28	27	26	22	28	27	26	22	27	27	25	21	25	25	24	21	
KW	2.58	2.63	2.72	2.80	2.78	2.84	2.93	3.02	2.95	3.02	3.11	3.22	3.11	3.17	3.28	3.39	3.24	3.31	3.42	3.53	3.35	3.43	3.54	3.66	
Amps	11.0	11.2	11.6	12.0	11.8	12.1	12.4	12.8	12.7	13.0	13.4	13.8	13.5	13.8	14.2	14.7	14.3	14.6	15.1	15.6	15.1	15.4	15.9	16.4	
Hi PR	236	254	268	280	265	285	301	314	301	324	342	357	343	369	390	406	386	415	438	457	426	459	484	505	
Lo PR	111	118	129	138	118	125	136	145	122	130	142	151	128	136	149	159	134	143	156	166	139	148	162	172	

IDB = Entering Indoor Dry Bulb Temperature

High and low pressures are measured at the liquid and suction access fittings.

Design Subcooling, 8-12 °F @ the liquid access fitting connection AHR1 95 test conditions. Design Superheat 8-12 °F @ the compressor suction access fitting connection.

Shaded area reflects AHR1 conditions.

Amps: Unit amps (comp.+ evaporator + condenser fan motors)

KW = Total system power

IDB	AIRFLOW	OUTDOOR AMBIENT TEMPERATURE																								
		65				75				85				95				105				115				
		59	63	67	71	59	63	67	71	59	63	67	71	59	63	67	71	59	63	67	71	59	63	67	71	
70	MBh	43.2	44.7	49.0	-	42.2	43.7	47.9	-	41.2	42.7	46.7	-	40.2	41.6	45.6	-	38.2	39.5	43.3	-	35.3	36.6	40.1	-	
	S/T	0.74	0.62	0.43	-	0.77	0.64	0.44	-	0.79	0.66	0.46	-	0.81	0.68	0.47	-	0.84	0.70	0.49	-	0.85	0.71	0.49	-	
	Delta T	20	17	13	-	20	17	13	-	20	17	13	-	20	17	13	-	20	17	13	-	19	16	12	-	
	1485	1448	2.72	2.78	2.87	-	2.94	3.00	3.10	-	3.12	3.19	3.30	-	3.29	3.36	3.48	-	3.43	3.51	3.63	-	3.55	3.64	3.76	-
	AMPS	11.5	11.8	12.1	-	12.4	12.6	13.0	-	13.3	13.6	14.0	-	14.2	14.5	14.9	-	15.0	15.3	15.8	-	15.8	16.2	16.7	-	
	Hi PR	237	255	269	-	266	286	302	-	302	325	343	-	344	370	391	-	387	417	440	-	428	460	486	-	
	Lo PR	109	116	127	-	115	123	134	-	120	127	139	-	125	134	146	-	132	140	153	-	136	145	158	-	
	MBh	41.9	43.4	47.6	-	40.9	42.4	46.5	-	40.0	41.4	45.4	-	39.0	40.4	44.3	-	37.0	38.4	42.1	-	34.3	35.6	39.0	-	
	S/T	0.71	0.59	0.41	-	0.73	0.61	0.42	-	0.75	0.63	0.43	-	0.78	0.65	0.45	-	0.80	0.67	0.47	-	0.81	0.68	0.47	-	
	Delta T	21	18	14	-	21	18	14	-	21	18	14	-	21	18	14	-	21	18	14	-	19	17	13	-	
1323	1290	2.70	2.76	2.85	-	2.91	2.98	3.07	-	3.10	3.17	3.27	-	3.26	3.34	3.45	-	3.40	3.48	3.60	-	3.52	3.60	3.73	-	
AMPS	11.4	11.7	12.0	-	12.3	12.5	12.9	-	13.2	13.5	13.9	-	14.0	14.4	14.8	-	14.9	15.2	15.7	-	15.7	16.1	16.6	-		
Hi PR	234	252	266	-	263	283	299	-	299	322	340	-	341	367	387	-	383	413	436	-	424	456	481	-		
Lo PR	108	115	125	-	114	121	133	-	119	126	138	-	125	133	145	-	131	139	152	-	135	144	151	-		
MBh	39.8	41.3	45.2	-	38.9	40.3	44.2	-	38.0	39.4	43.1	-	37.0	38.4	42.1	-	35.2	36.5	40.0	-	32.6	33.8	37.0	-		
S/T	0.68	0.57	0.39	-	0.70	0.59	0.41	-	0.72	0.60	0.42	-	0.74	0.62	0.43	-	0.77	0.64	0.45	-	0.78	0.65	0.45	-		
Delta T	21	18	14	-	21	19	14	-	21	19	14	-	22	19	14	-	21	18	14	-	20	17	13	-		
1171	1142	2.66	2.71	2.80	-	2.86	2.93	3.02	-	3.05	3.11	3.22	-	3.21	3.28	3.39	-	3.35	3.42	3.54	-	3.46	3.54	3.66	-	
AMPS	11.2	11.5	11.8	-	12.0	12.3	12.7	-	13.0	13.3	13.7	-	13.8	14.1	14.5	-	14.6	15.0	15.4	-	15.4	15.8	16.3	-		
Hi PR	230	247	261	-	258	277	293	-	293	316	333	-	334	359	380	-	376	404	427	-	415	447	472	-		
Lo PR	106	113	123	-	112	119	130	-	116	124	135	-	122	130	142	-	128	136	149	-	132	141	154	-		

75	MBh	43.9	45.2	48.9	52.5	42.9	44.2	47.8	51.3	41.9	43.1	46.7	50.1	40.8	42.0	45.5	48.8	38.8	39.9	43.2	46.4	35.9	37.0	40.1	43.0	
	S/T	0.84	0.75	0.57	0.37	0.87	0.78	0.59	0.38	0.90	0.80	0.61	0.39	0.92	0.83	0.63	0.40	0.96	0.86	0.65	0.42	0.97	0.86	0.65	0.42	
	ΔT	23	21	17	12	23	21	17	12	23	21	18	12	23	22	18	12	23	21	17	12	22	20	16	11	
	1485	KW	2.74	2.80	2.89	2.99	2.96	3.03	3.12	3.23	3.15	3.22	3.33	3.44	3.32	3.39	3.51	3.63	3.46	3.54	3.66	3.79	3.59	3.67	3.79	3.92
	Amps	11.6	11.9	12.2	12.6	12.5	12.7	13.1	13.6	13.4	13.7	14.2	14.6	14.3	14.6	15.1	15.6	15.1	15.5	16.0	16.5	16.0	16.3	16.9	17.5	
	Hi PR	239	257	272	284	268	289	305	318	305	329	347	362	348	374	395	412	391	421	445	464	432	465	491	512	
	Lo PR	110	117	128	136	116	124	135	144	121	129	141	150	127	135	148	157	133	142	155	165	138	147	160	170	
	MBh	42.6	43.9	47.5	51.0	41.6	42.9	46.4	49.8	40.6	41.8	45.3	48.6	39.7	40.8	44.2	47.4	37.7	38.8	42.0	45.1	34.9	35.9	38.9	41.7	
	S/T	0.80	0.72	0.54	0.35	0.83	0.74	0.56	0.36	0.85	0.76	0.58	0.37	0.88	0.79	0.60	0.38	0.91	0.82	0.62	0.40	0.92	0.82	0.62	0.40	
	ΔT	24	22	18	12	24	22	18	13	24	22	18	13	24	22	18	13	24	22	18	12	22	21	17	12	
1323	KW	2.72	2.78	2.87	2.96	2.94	3.00	3.10	3.20	3.12	3.19	3.30	3.41	3.29	3.37	3.48	3.60	3.43	3.51	3.63	3.75	3.56	3.64	3.76	3.89	
Amps	11.5	11.8	12.1	12.5	12.4	12.6	13.0	13.4	13.3	13.6	14.0	14.5	14.2	14.5	14.9	15.5	15.0	15.3	15.8	16.4	15.8	16.2	16.7	17.3		
Hi PR	237	255	269	281	266	286	302	315	302	325	344	358	344	371	391	408	387	417	440	459	428	461	486	507		
Lo PR	109	116	127	135	115	123	134	143	120	128	139	148	126	134	146	156	132	140	153	163	136	145	159	169		
MBh	40.5	41.7	45.1	48.4	39.6	40.7	44.1	47.3	38.6	39.8	43.0	46.2	37.7	38.8	42.0	45.1	35.8	36.8	39.9	42.8	33.1	34.1	36.9	39.6		
S/T	0.77	0.69	0.52	0.34	0.80	0.71	0.54	0.35	0.82	0.73	0.55	0.36	0.84	0.75	0.57	0.37	0.88	0.78	0.59	0.38	0.88	0.79	0.60	0.38		
ΔT	24	23	18	13	25	23	19	13	25	23	19	13	25	23	19	13	25	23	19	13	23	21	17	12		
1171	KW	2.68	2.74	2.82	2.92	2.89	2.95	3.05	3.15	3.07	3.14	3.24	3.35	3.24	3.31	3.42	3.53	3.37	3.45	3.57	3.69	3.49	3.57	3.69	3.82	
Amps	11.3	11.6	11.9	12.3	12.2	12.4	12.8	13.2	13.1	13.4	13.8	14.3	13.9	14.2	14.7	15.2	14.7	15.1	15.6	16.1	15.6	15.9	16.4	17.0		
Hi PR	232	250	264	275	260	280	296	309	296	319	337	351	337	363	383	400	380	408	431	450	419	451	477	497		
Lo PR	107	114	124	132	113	120	131	140	117	125	136	145	123	131	143	153	129	138	150	160	134	142	155	165		

IDB = Entering Indoor Dry Bulb Temperature
 High and low pressures are measured at the liquid and suction access fittings.
 Design Subcooling: 8-12 °F @ the liquid access fitting connection AHRI 95 test conditions. Design Superheat 8-12°F @ the compressor suction access fitting connection.
 Shaded area reflects AHRI (TVA) conditions.
 Amps: Unit amps (comp.+ evaporator + condenser fan motors)
 KW = Total system power

IDB		OUTDOOR AMBIENT TEMPERATURE												105												115																																																																																																																																																																																																																																																																																																																																																																																																																																																																																																																																																																																																																																																																																																																																																																																																																																																																																																																																																																																																																																																																																																																																																																																																																																																																																																																																																		
		65						75						85						95						105						115																																																																																																																																																																																																																																																																																																																																																																																																																																																																																																																																																																																																																																																																																																																																																																																																																																																																																																																																																																																																																																																																																																																																																																																																																																																																																																																																												
		59	63	67	71	75	79	59	63	67	71	75	79	59	63	67	71	75	79	59	63	67	71	75	79	59	63	67	71	75	79	59	63	67	71	75	79																																																																																																																																																																																																																																																																																																																																																																																																																																																																																																																																																																																																																																																																																																																																																																																																																																																																																																																																																																																																																																																																																																																																																																																																																																																																																																																																							
1485		MBh	44.7	45.7	48.8	52.1	43.6	44.6	47.6	50.9	42.6	43.5	46.5	49.7	41.6	42.5	45.4	48.5	39.5	40.4	43.1	46.1	36.6	37.4	39.9	42.7	MBh	43.4	44.3	47.4	50.6	42.4	43.3	46.3	49.5	41.4	42.3	45.2	48.3	40.4	41.2	44.1	47.1	38.3	39.2	41.9	44.7	35.5	36.3	38.8	41.4	MBh	44.1	45.0	48.1	51.3	43.1	44.0	47.0	50.2	41.9	42.8	45.7	48.8	40.7	41.5	44.4	47.4	38.5	39.4	42.1	45.0	36.3	37.1	39.6	42.4	MBh	43.7	44.6	47.7	50.9	42.5	43.4	46.4	49.6	41.3	42.2	45.1	48.1	40.0	40.8	43.7	46.6	38.7	39.6	42.3	45.2	36.5	37.3	39.8	42.6	MBh	44.0	44.9	48.0	51.2	43.0	43.9	46.9	50.1	41.6	42.5	45.4	48.4	40.3	41.1	44.0	47.0	38.1	39.0	41.7	44.6	35.8	36.6	39.1	41.9	MBh	43.9	44.8	47.9	51.1	42.9	43.8	46.8	50.0	41.5	42.4	45.3	48.3	40.2	41.0	43.9	46.8	38.9	39.8	42.5	45.4	36.6	37.4	39.9	42.7	MBh	44.2	45.1	48.2	51.4	43.2	44.1	47.1	50.3	41.8	42.7	45.6	48.6	40.5	41.3	44.2	47.2	38.3	39.2	41.9	44.8	36.7	37.5	40.0	42.8	MBh	44.5	45.4	48.5	51.7	43.5	44.4	47.4	50.6	42.0	42.9	45.8	48.8	40.8	41.6	44.5	47.5	38.5	39.4	42.1	45.0	36.8	37.6	40.1	42.9	MBh	44.8	45.7	48.8	52.0	43.8	44.7	47.7	50.9	42.3	43.2	46.1	49.1	41.1	41.9	44.8	47.8	38.7	39.6	42.3	45.2	36.9	37.7	40.2	43.0	MBh	45.1	46.0	49.1	52.3	44.1	45.0	48.0	51.2	42.6	43.5	46.4	49.4	41.4	42.2	45.1	48.1	39.1	40.0	42.7	45.6	37.0	37.8	40.3	43.1	MBh	45.4	46.3	49.4	52.6	44.4	45.3	48.3	51.5	42.9	43.8	46.7	49.7	41.7	42.5	45.4	48.4	39.3	40.2	42.9	45.8	37.1	37.9	40.4	43.2	MBh	45.7	46.6	49.7	52.9	44.7	45.6	48.6	51.8	43.2	44.1	47.0	50.2	42.0	42.8	45.7	48.7	39.5	40.4	43.1	46.0	37.2	38.0	40.5	43.3	MBh	46.0	46.9	50.0	53.2	45.0	45.9	48.9	52.1	43.5	44.4	47.3	50.5	42.3	43.1	46.0	49.0	39.7	40.6	43.3	46.2	37.3	38.1	40.6	43.4	MBh	46.3	47.2	50.3	53.5	45.3	46.2	49.2	52.4	43.8	44.7	47.6	50.8	42.6	43.4	46.3	49.3	39.9	40.8	43.5	46.4	37.4	38.2	40.7	43.5	MBh	46.6	47.5	50.6	53.8	45.6	46.5	49.5	52.7	44.1	45.0	47.9	51.1	42.9	43.7	46.6	49.6	40.1	41.0	43.7	46.6	37.5	38.3	40.8	43.6	MBh	46.9	47.8	50.9	54.1	45.9	46.8	49.8	53.0	44.4	45.3	48.2	51.4	43.2	44.0	46.9	49.9	40.3	41.2	43.9	46.8	37.6	38.4	40.9	43.7	MBh	47.2	48.1	51.2	54.4	46.2	47.1	50.1	53.3	44.7	45.6	48.5	51.7	43.5	44.3	47.2	50.2	40.5	41.4	44.1	47.0	37.7	38.5	41.0	43.8	MBh	47.5	48.4	51.5	54.7	46.5	47.4	50.4	53.6	45.0	45.9	48.8	52.0	43.8	44.6	47.5	50.5	40.7	41.6	44.3	47.2	37.8	38.6	41.1	43.9	MBh	47.8	48.7	51.8	55.0	46.8	47.7	50.7	53.9	45.3	46.2	49.1	52.3	44.1	44.9	47.8	50.8	40.9	41.8	44.5	47.4	37.9	38.7	41.2	44.0	MBh	48.1	49.0	52.1	55.3	47.1	48.0	51.0	54.2	45.6	46.5	49.4	52.6	44.4	45.2	48.1	51.1	41.1	42.0	44.7	47.6	38.0	38.8	41.3	44.1	MBh	48.4	49.3	52.4	55.6	47.4	48.3	51.3	54.5	45.9	46.8	49.7	52.9	44.7	45.5	48.4	51.4	41.3	42.2	44.9	47.8	38.1	38.9	41.4	44.2	MBh	48.7	49.6	52.7	55.9	47.7	48.6	51.6	54.8	46.2	47.1	50.0	53.2	45.0	45.8	48.7	51.7	41.5	42.4	45.1	48.0	38.2	39.0	41.5	44.3	MBh	49.0	49.9	53.0	56.2	48.0	48.9	51.9	55.1	46.5	47.4	50.3	53.5	45.3	46.1	49.0	52.0	41.7	42.6	45.3	48.2	38.3	39.1	41.6	44.4	MBh	49.3	50.2	53.3	56.5	48.3	49.2	52.2	55.4	46.8	47.7	50.6	53.8	45.6	46.4	49.3	52.3	41.9	42.8	45.5	48.4	38.4	39.2	41.7	44.5	MBh	49.6	50.5	53.6	56.8	48.6	49.5	52.5	55.7	47.1	48.0	50.9	54.1	45.9	46.7	49.6	52.6	42.1	43.0	45.7	48.6	38.5	39.3	41.8	44.6	MBh	49.9	50.8	53.9	57.1	48.9	49.8	52.8	56.0	47.4	48.3	51.2	54.4	46.2	47.0	49.9	52.9	42.3	43.2	45.9	48.8	38.6	39.4	41.9	44.7	MBh	50.2	51.1	54.2	57.4	49.2	50.1	53.1	56.3	47.7	48.6	51.5	54.7	46.5	47.3	50.2	53.1	42.5	43.4	46.1	49.0	38.7	39.5	42.0	44.8	MBh	50.5	51.4	54.5	57.7	49.5	50.4	53.4	56.6	48.0	49.3	52.2	55.4	46.8	47.6	50.5	53.4	42.7	43.6	46.3	49.2	38.8	39.6	42.1	44.9	MBh	50.8	51.7	54.8	58.0	49.8	50.7	53.7	56.9	48.3	49.6	52.5	55.7	47.1	47.9	50.8	53.6	42.9	43.8	46.5	49.4	38.9	39.7	42.2	45.0	MBh	51.1	52.0	55.1	58.3	50.1	51.0	54.0	57.2	48.6	49.9	52.8	56.0	47.4	48.2	51.1	54.0	43.1	44.0	46.7	49.6	39.0	39.8	42.3	45.1	MBh	51.4	52.3	55.4	58.6	50.4	51.3	54.3	57.5	48.9	50.2	53.1	56.3	47.7	48.5	51.4	54.3	43.3	44.2	46.9	49.8	39.1	39.9	42.4	45.2	MBh	51.7	52.6	55.7	58.9	50.7	51.6	54.6	57.8	49.2	50.5	53.4	56.6	48.0	48.8	51.7	54.6	43.5	44.4	47.1	50.0	39.2	40.0	42.5	45.3	MBh	52.0	52.9	56.0	59.2	51.0	51.9	54.9	58.1	49.5	50.8	53.7	56.9	48.3	49.1	52.0	54.9	43.7	44.6	47.3	50.2	39.3	40.1	42.6	45.4	MBh	52.3	53.2	56.3	59.5	51.3	52.2	55.2	58.4	49.8	51.1	54.0	57.2	48.6	49.4	52.3	55.2	43.9	44.8	47.5	50.4	39.4	40.2	42.7	45.5	MBh	52.6	53.5	56.6	59.8	51.6	52.5	55.5	58.7	50.1	51.4	54.3	57.5	48.9	49.7	52.6	55.5	44.1	45.0	47.7	50.6	39.5	40.3	42.8	45.6	MBh	52.9	53.8	56.9	60.1	51.9	52.8	55.8	59.0	50.4	51.7	54.6	57.8	49.2	50.0	52.9	55.8	44.3	45.2	47.9	50.8	39.6	40.4	42.9	45.7	MBh	53.2	54.1	57.2	60.4	52.2	53.1	56.1	59.3	50.7	52.0	54.9	58.1	49.5	50.3	53.2	56.1	44.5	45.4	48.1	51.0	39.7	40.5	43.0	45.8	MBh	53.5	54.4	57.5	60.7	52.5	53.4	56.4	59.6	51.0	52.3	55.2	58.4	49.8	50.6	53.5	56.4	44.7	45.6	48.3	51.2	39.8	40.6	43.1	45.9	MBh	53.8	54.7	57.8	61.0	52.8	53.7	56.7	59.9	51.3	53.0	55.9	58.7	50.1	50.9	53.8	56.6	44.9	45.8	48.5	51.4	39.9	40.7	43.2	46.0	MBh	54.1	55.0	58.1	61.3	53.1	54.0	57.0	60.2	51.6	52.9	55.8	58.9	50.4	51.2	54.1	57.0	45.1	46.0	48.7	51.6	40.0	40.8	43.3	46.1	MBh	54.4	55.3	58.4	61.6	53.4	54.3	57.3	60.5	51.9	53.2	56.1	59.2	50.7	51.5	54.4	57.3	45.3	46.2	48.9	51.8	40.1	40.9	43.4	46.2	MBh	54.7	55.6	58.7	61.9	53.7	54.6	57.6	60.8	52.2	53.5	56.4	59.5	51.0	51.8	54.7	57.6	45.5	46.4	49.1	52.0	40.2	40.9	43.5	46.3	MBh	55.0	55.9	59.0	62.2	54.0	54.9	57.9	61.1	52.5	54.2	57.1	60.0	51.3	52.1	55.0	57.9	45.7	46.6	49.3	52.2	40.3	41.0	43.6	46.4	MBh	55.3	56.2	59.3	62.5	54.3	55.2	58.2	61.4	52.8	54.5	57.4	60.3	51.6	52.4	55.3	58.2	45.9	46.8	49.5	52.4	40.4	41.1	43.7	46.5	MBh	55.6	56.5	59.6	62.8	54.6	55.5	58.5	61.7	53.1	54.8	57.7	60.6	51.9	52.7	55.6	58.5	46.1	47.0	49.7	52.6	40.5	41.2	43.8	46.6	MBh	55.9	56.8	59.9	63.1	54.9	55.8	58.8	62.0	53.4	55.1	58.0	60.9	52.2	53.0	55.9	58.8	46.3	47.2	49.9	52.8	40.6	41.3	43.9	46.7	MBh	56.2	57.1	60.2	63.4	55.2	56.1	59.1	62.3	53.7	55.4	58.3	61.2	52.5	53.3	56.2	59.1	46.5	47.4	50.1	53.0	40.7	41.4	44.0	46.8	MBh	56.5	57.4	60.5	63.7	55.5	56.4	59.4	62.6	54.0	55.7	58.6	61.5	52.8	53.5	56.4	59.4	46.7	47.6	50.3	53.2	40.8	41.5	44.1	46.9	MBh	56.8	57.7	60.8	64.0	55.8	56.7	59.7	62.9	54.3	56.0	58.9	61.8	53.1	53.9	56.8	59.7	46.9	47.8	50.5	53.4	40.9	41.6	44.2	47.0	MBh	57.1	58.0	61.1	64.3	56.1	57.0	60.0	63.2	54.6	56.3	59.2	62.1	53.4	54.2	57.1	60.0	47.1	48.0	50.7	53.6	41.0	41.7	44.3	47.1	MBh	57.4	58.3	61.4	64.6	56.4	57.3	60.3	63.5	54.9	56.6	59.5	62.4	53.7	54.5	57.4	60.3	47.3	48.2	50.9	53.8	41.1	41.8	44.4	47.2	MBh	57.7	58.6	61.7	64.9	56.7	57.6	60.6	63.8	55.2	56.9	59.8	62.7	54.0	54.8	57.7	60.6	47.5	48.4	51.1	54.0	41.2	41.9	44.5	47.3	MBh	58.0	58.9	62.0	65.2	57.0	57.9	60.9	64.1	55.5	57.2	60.1	63.0	54.3	55.1	58.0	60.9	47.7	48.6	51.3	54.2	41.3	42.0

IDB	AIRFLOW	OUTDOOR AMBIENT TEMPERATURE																								
		65				75				85				95				105				115				
		59	63	67	71	59	63	67	71	59	63	67	71	59	63	67	71	59	63	67	71	59	63	67	71	
70	1800	MBh	45.1	46.7	51.2	-	44.0	45.6	50.0	-	43.0	44.5	48.8	-	41.9	43.5	47.6	-	39.8	41.3	45.2	-	36.9	38.2	41.9	-
		S/T	0.75	0.63	0.43	-	0.78	0.65	0.45	-	0.80	0.66	0.46	-	0.82	0.69	0.48	-	0.85	0.71	0.49	-	0.86	0.72	0.50	-
		ΔT	17	15	11	-	17	15	11	-	17	15	11	-	18	15	12	-	17	15	11	-	16	14	11	-
		KW	3.03	3.09	3.19	-	3.27	3.34	3.45	-	3.48	3.56	3.67	-	3.66	3.75	3.87	-	3.82	3.91	4.04	-	3.96	4.05	4.19	-
		Amps	13.3	13.6	14.0	-	14.3	14.6	15.0	-	15.4	15.7	16.2	-	16.3	16.7	17.2	-	17.3	17.7	18.2	-	18.2	18.6	19.2	-
	1600	Hi PR	241	260	274	-	271	291	308	-	308	331	350	-	351	377	398	-	394	424	448	-	436	469	495	-
		Lo PR	109	116	127	-	116	123	134	-	120	128	140	-	126	134	147	-	132	141	154	-	137	146	159	-
		MBh	43.8	45.4	49.7	-	42.7	44.3	48.5	-	41.7	43.2	47.4	-	40.7	42.2	46.2	-	38.7	40.1	43.9	-	35.8	37.1	40.7	-
		S/T	0.71	0.60	0.41	-	0.74	0.62	0.43	-	0.76	0.63	0.44	-	0.78	0.65	0.45	-	0.81	0.68	0.47	-	0.82	0.69	0.47	-
		ΔT	18	16	12	-	18	16	12	-	18	16	12	-	18	16	12	-	18	16	12	-	17	15	11	-
1400	KW	3.00	3.07	3.17	-	3.24	3.31	3.42	-	3.45	3.53	3.64	-	3.63	3.72	3.84	-	3.79	3.88	4.01	-	3.93	4.02	4.15	-	
	Amps	13.2	13.5	13.9	-	14.2	14.5	14.9	-	15.2	15.6	16.0	-	16.2	16.6	17.1	-	17.1	17.5	18.1	-	18.1	18.5	19.0	-	
	Hi PR	239	257	271	-	268	288	305	-	305	328	346	-	347	374	394	-	391	420	444	-	431	464	490	-	
	Lo PR	108	115	126	-	114	122	133	-	119	127	138	-	125	133	145	-	131	139	152	-	135	144	157	-	
	MBh	40.4	41.9	45.9	-	39.5	40.9	44.8	-	38.5	39.9	43.7	-	37.6	38.9	42.7	-	35.7	37.0	40.5	-	33.1	34.3	37.5	-	

IDB	AIRFLOW	OUTDOOR AMBIENT TEMPERATURE																								
		65				75				85				95				105				115				
		59	63	67	71	59	63	67	71	59	63	67	71	59	63	67	71	59	63	67	71	59	63	67	71	
75	1800	MBh	45.8	47.2	51.1	54.8	44.8	46.1	49.9	53.6	43.7	45.0	48.7	52.3	42.6	43.9	47.5	51.0	40.5	41.7	45.1	48.5	37.5	38.6	41.8	44.9
		S/T	0.85	0.76	0.58	0.37	0.88	0.79	0.60	0.38	0.91	0.81	0.61	0.39	0.93	0.84	0.63	0.41	0.97	0.87	0.66	0.42	0.98	0.87	0.66	0.43
		ΔT	20	18	15	10	20	19	15	11	20	19	15	11	20	19	15	11	20	18	15	10	19	17	14	10
		KW	3.05	3.12	3.22	3.33	3.30	3.37	3.48	3.60	3.51	3.59	3.71	3.83	3.70	3.78	3.91	4.04	3.86	3.94	4.08	4.22	3.99	4.09	4.22	4.37
		Amps	13.4	13.7	14.1	14.6	14.4	14.7	15.1	15.6	15.5	15.8	16.3	16.9	16.5	16.8	17.3	17.9	17.4	17.8	18.4	19.0	18.4	18.8	19.4	20.1
	1600	Hi PR	244	262	277	289	273	294	311	324	311	335	353	369	354	381	402	420	398	429	453	472	440	474	500	522
		Lo PR	111	118	128	137	117	124	136	144	121	129	141	150	127	136	148	158	134	142	155	165	138	147	160	171
		MBh	44.5	45.8	49.6	53.2	43.5	44.8	48.4	52.0	42.4	43.7	47.3	50.8	41.4	42.6	46.1	49.5	39.3	40.5	43.8	47.0	36.4	37.5	40.6	43.6
		S/T	0.81	0.73	0.55	0.35	0.84	0.75	0.57	0.37	0.86	0.77	0.58	0.38	0.89	0.80	0.60	0.39	0.92	0.83	0.63	0.40	0.93	0.83	0.63	0.41
		ΔT	21	19	16	11	21	19	16	11	21	19	16	11	21	20	16	11	21	19	16	11	20	18	15	10
1400	KW	3.03	3.10	3.20	3.30	3.27	3.34	3.45	3.57	3.48	3.56	3.68	3.80	3.67	3.75	3.87	4.01	3.82	3.91	4.04	4.18	3.96	4.05	4.19	4.33	
	Amps	13.3	13.6	14.0	14.5	14.3	14.6	15.0	15.5	15.4	15.7	16.2	16.7	16.3	16.7	17.2	17.8	17.3	17.7	18.2	18.8	18.2	18.6	19.2	19.9	
	Hi PR	241	260	274	286	271	291	308	321	308	331	350	365	351	377	398	416	394	425	448	468	436	469	495	517	
	Lo PR	109	116	127	135	116	123	134	143	120	128	140	149	126	134	147	156	132	141	154	164	137	146	159	169	
	MBh	41.1	42.3	45.8	49.1	40.1	41.3	44.7	48.0	39.2	40.3	43.7	46.8	38.2	39.3	42.6	45.7	36.3	37.4	40.5	43.4	33.6	34.6	37.5	40.2	

IDB = Entering Indoor Dry Bulb Temperature
 High and low pressures are measured at the liquid and suction access fittings.
 Design Subcooling, 10-13 °F @ the liquid access fitting connection AHR1 95 test conditions. Design Superheat 10-14 °F @ the compressor suction access fitting connection.
 Shaded area reflects AHR1 (TVA) conditions.
 Amps: Unit amps (comp.+ evaporator + condenser fan motors)
 KW = Total system power

IDB	AIRFLOW	OUTDOOR AMBIENT TEMPERATURE												ENTERING INDOOR WET BULB TEMPERATURE											
		65				75				85				95				105				115			
		59	63	67	71	59	63	67	71	59	63	67	71	59	63	67	71	59	63	67	71	59	63	67	71
80	Mbh	46.7	47.7	50.9	54.4	45.6	46.6	49.7	53.2	44.5	45.5	48.6	51.9	43.4	44.3	47.4	50.6	41.2	42.1	45.0	48.1	38.2	39.0	41.7	44.6
	S/T	0.93	0.88	0.71	0.53	0.97	0.91	0.74	0.55	1.00	0.93	0.76	0.57	1.00	0.96	0.78	0.58	1.00	1.00	0.81	0.61	1.00	1.00	0.82	0.61
	ΔT	22	21	19	15	23	22	19	15	23	22	19	15	22	22	19	15	21	22	19	15	20	20	17	14
	KW	3.08	3.15	3.25	3.36	3.32	3.40	3.51	3.63	3.54	3.62	3.74	3.86	3.73	3.81	3.94	4.08	3.89	3.98	4.11	4.25	4.03	4.12	4.26	4.41
	Amps	13.5	13.8	14.2	14.7	14.5	14.8	15.3	15.8	15.6	16.0	16.5	17.0	16.6	17.0	17.5	18.1	17.6	18.0	18.5	19.2	18.5	19.0	19.5	20.2
	Hi PR	246	265	280	292	276	297	314	327	314	338	357	372	358	385	407	424	402	433	457	477	445	479	505	527
	Lo PR	112	119	130	138	118	125	137	146	123	130	142	152	129	137	150	159	135	144	157	167	140	148	162	173
	Mbh	45.3	46.3	49.5	52.9	44.2	45.2	48.3	51.6	43.2	44.1	47.2	50.4	42.1	43.1	46.0	49.2	40.0	40.9	43.7	46.7	37.1	37.9	40.5	43.3
	S/T	0.89	0.84	0.68	0.51	0.92	0.87	0.70	0.53	0.95	0.89	0.72	0.54	0.98	0.92	0.75	0.56	1.00	0.95	0.77	0.58	1.00	0.96	0.78	0.58
	ΔT	23	22	19	15	23	22	20	16	23	23	20	16	24	23	20	16	24	23	22	19	21	21	18	15
KW	3.05	3.12	3.22	3.33	3.30	3.37	3.48	3.60	3.51	3.59	3.71	3.83	3.70	3.78	3.91	4.04	3.86	3.94	4.08	4.22	3.99	4.09	4.22	4.37	
Amps	13.4	13.7	14.1	14.6	14.4	14.7	15.1	15.6	15.5	15.8	16.3	16.9	16.5	16.8	17.3	17.9	17.4	17.8	18.4	19.0	18.4	18.8	19.4	20.1	
Hi PR	244	262	277	289	273	294	311	324	311	335	353	369	354	381	403	420	398	429	453	472	440	474	500	522	
Lo PR	111	118	128	137	117	124	136	144	121	129	141	150	127	136	148	158	134	142	155	165	138	147	160	171	
Mbh	41.8	42.7	45.6	48.8	40.8	41.7	44.6	47.7	39.9	40.7	43.5	46.5	38.9	39.7	42.5	45.4	36.9	37.8	40.3	43.1	34.2	35.0	37.4	39.9	
S/T	0.86	0.81	0.66	0.49	0.89	0.83	0.68	0.51	0.91	0.86	0.70	0.52	0.94	0.88	0.72	0.54	0.98	0.92	0.75	0.56	0.99	0.92	0.75	0.56	
ΔT	24	23	20	16	24	23	20	16	24	23	20	16	24	23	20	16	24	23	20	16	22	21	18	15	
KW	2.98	3.04	3.14	3.25	3.21	3.28	3.39	3.50	3.42	3.50	3.61	3.73	3.60	3.68	3.81	3.94	3.76	3.84	3.97	4.11	3.89	3.98	4.11	4.26	
Amps	13.1	13.4	13.8	14.2	14.0	14.3	14.8	15.3	15.1	15.5	15.9	16.5	16.1	16.4	16.9	17.5	17.0	17.4	17.9	18.5	17.9	18.3	18.9	19.5	
Hi PR	236	254	269	280	265	285	301	314	302	325	343	358	344	370	390	407	387	416	439	458	427	460	485	506	
Lo PR	107	114	125	133	113	120	132	140	118	125	137	146	124	132	144	153	130	138	151	160	134	143	156	166	
85	Mbh	47.5	48.4	50.7	54.1	46.4	47.3	49.5	52.8	45.3	46.1	48.3	51.6	44.2	45.0	47.1	50.3	42.0	42.8	44.8	47.8	38.9	39.6	41.5	44.3
	S/T	0.98	0.94	0.85	0.69	1.00	0.98	0.88	0.72	1.00	1.00	0.91	0.74	1.00	1.00	0.94	0.76	1.00	1.00	0.97	0.79	1.00	1.00	0.98	0.79
	ΔT	24	23	22	19	24	24	22	19	23	24	22	19	23	23	20	19	21	22	22	19	20	20	21	18
	KW	3.10	3.17	3.28	3.38	3.35	3.42	3.54	3.66	3.57	3.65	3.77	3.90	3.76	3.84	3.97	4.11	3.92	4.01	4.15	4.29	4.06	4.16	4.30	4.45
	Amps	13.6	13.9	14.3	14.8	14.6	14.9	15.4	15.9	15.8	16.1	16.6	17.2	16.7	17.1	17.6	18.3	17.7	18.1	18.7	19.3	18.7	19.1	19.7	20.4
	Hi PR	249	268	282	295	279	300	317	331	317	341	360	376	361	389	411	428	406	437	462	482	449	483	510	532
	Lo PR	113	120	131	139	119	127	138	147	124	132	144	153	130	138	151	161	136	145	158	169	141	150	164	174
	Mbh	46.1	47.0	49.2	52.5	45.0	45.9	48.1	51.3	43.9	44.8	46.9	50.1	42.9	43.7	45.8	48.8	40.7	41.5	43.5	46.4	37.7	38.5	40.3	43.0
	S/T	0.93	0.90	0.81	0.66	0.97	0.93	0.84	0.68	0.99	0.96	0.86	0.70	1.00	0.99	0.89	0.72	1.00	1.00	0.93	0.75	1.00	1.00	0.93	0.76
	ΔT	25	24	23	20	25	25	23	20	25	25	23	20	25	25	23	20	23	24	23	20	22	22	22	19
KW	3.08	3.15	3.25	3.36	3.32	3.40	3.51	3.63	3.54	3.62	3.74	3.86	3.73	3.81	3.94	4.08	3.89	3.98	4.11	4.25	4.03	4.12	4.26	4.41	
Amps	13.5	13.8	14.2	14.7	14.5	14.8	15.3	15.8	15.6	16.0	16.5	17.0	16.6	17.0	17.5	18.1	17.6	18.0	18.5	19.2	18.5	19.0	19.5	20.2	
Hi PR	246	265	280	292	276	297	314	327	314	338	357	372	358	385	407	424	402	433	457	477	445	479	505	527	
Lo PR	112	119	130	138	118	125	137	146	123	130	142	152	129	137	150	159	135	144	157	167	140	148	162	173	
Mbh	42.5	43.4	45.4	48.5	41.5	42.4	44.4	47.3	40.6	41.3	43.3	46.2	39.6	40.3	42.2	45.1	37.6	38.3	40.1	42.8	34.8	35.5	37.2	39.7	
S/T	0.90	0.87	0.78	0.64	0.93	0.90	0.81	0.66	0.96	0.92	0.83	0.68	0.99	0.95	0.86	0.70	1.00	0.99	0.89	0.72	1.00	1.00	0.90	0.73	
ΔT	25	25	23	20	25	25	24	20	25	25	24	21	26	25	24	21	26	25	24	21	25	25	23	22	
KW	3.00	3.07	3.17	3.27	3.24	3.31	3.42	3.53	3.45	3.53	3.64	3.77	3.63	3.71	3.84	3.97	3.79	3.88	4.01	4.14	3.92	4.01	4.15	4.29	
Amps	13.2	13.5	13.9	14.3	14.2	14.5	14.9	15.4	15.2	15.6	16.0	16.6	16.2	16.5	17.0	17.6	17.1	17.5	18.1	18.7	18.1	18.5	19.0	19.7	
Hi PR	239	257	271	283	268	288	304	318	305	328	346	361	347	373	394	411	390	420	444	463	431	464	490	511	
Lo PR	108	115	126	134	114	122	133	141	119	126	138	147	125	133	145	154	131	139	152	162	135	144	157	167	

IDB = Entering Indoor Dry Bulb Temperature

High and low pressures are measured at the liquid and suction access fittings.

Design Subcooling, -10-13 °F @ the liquid access fitting connection AHRI 95 test conditions. Design Superheat 10-14 °F @ the compressor suction access fitting connection.

Shaded area reflects AHRI conditions.

Amps: Unit amps (comp.+ evaporator + condenser fan motors)

KW = Total system power

IDB	AIRFLOW	OUTDOOR AMBIENT TEMPERATURE												115																	
		65						75						85						95						105					
		59	63	67	71	59	63	67	71	59	63	67	71	59	63	67	71	59	63	67	71	59	63	67	71	59	63	67	71		
70	1908	MBh	58.8	60.9	66.7	-	57.4	59.5	65.2	-	56.0	58.1	63.6	-	54.7	56.6	62.1	-	51.9	53.8	59.0	-	48.1	49.8	54.6	-					
		S/T	0.70	0.59	0.41	-	0.73	0.61	0.42	-	0.75	0.62	0.43	-	0.77	0.64	0.45	-	0.80	0.67	0.46	-	0.81	0.67	0.47	-					
		ΔT	20	17	13	-	20	17	13	-	20	17	13	-	20	18	13	-	20	17	13	-	19	16	12	-					
		KW	3.87	3.95	4.08	-	4.17	4.27	4.41	-	4.44	4.54	4.70	-	4.68	4.79	4.95	-	4.89	5.00	5.17	-	5.06	5.18	5.35	-					
		Amps	16.9	17.3	17.8	-	18.2	18.6	19.2	-	19.7	20.1	20.7	-	20.9	21.4	22.1	-	22.2	22.7	23.4	-	23.4	24.0	24.7	-					
	1700	Hi PR	252	271	286	-	282	304	321	-	321	346	365	-	366	394	416	-	411	443	468	-	455	489	517	-					
		Lo PR	106	112	123	-	111	119	129	-	116	123	135	-	122	129	141	-	128	136	148	-	132	140	153	-					
		MBh	57.0	59.1	64.8	-	55.7	57.7	63.3	-	54.4	56.4	61.8	-	53.1	55.0	60.3	-	50.4	52.2	57.2	-	46.7	48.4	53.0	-					
		S/T	0.67	0.56	0.39	-	0.70	0.58	0.40	-	0.71	0.60	0.41	-	0.74	0.61	0.43	-	0.76	0.64	0.44	-	0.77	0.64	0.45	-					
		ΔT	21	18	14	-	21	18	14	-	21	18	14	-	21	18	14	-	21	18	14	-	19	17	13	-					
1504	KW	3.84	3.92	4.05	-	4.14	4.23	4.37	-	4.41	4.51	4.66	-	4.64	4.75	4.91	-	4.84	4.95	5.12	-	5.02	5.13	5.31	-						
	Amps	16.8	17.2	17.7	-	18.0	18.4	19.0	-	19.5	19.9	20.6	-	20.7	21.2	21.9	-	22.0	22.5	23.2	-	23.2	23.8	24.5	-						
	Hi PR	249	268	283	-	280	301	318	-	318	342	361	-	362	390	412	-	407	438	463	-	450	484	511	-						
	Lo PR	104	111	121	-	110	117	128	-	115	122	133	-	120	128	140	-	126	134	147	-	131	139	152	-						
	MBh	54.2	56.2	61.5	-	52.9	54.9	60.1	-	51.7	53.6	58.7	-	50.4	52.2	57.2	-	47.9	49.6	54.4	-	44.4	46.0	50.4	-						
75	1908	S/T	0.64	0.54	0.37	-	0.67	0.56	0.39	-	0.68	0.57	0.39	-	0.70	0.59	0.41	-	0.73	0.61	0.42	-	0.74	0.62	0.43	-					
		ΔT	21	18	14	-	22	19	14	-	22	19	14	-	22	19	14	-	21	19	14	-	20	17	13	-					
		KW	3.77	3.86	3.98	-	4.07	4.16	4.30	-	4.33	4.43	4.58	-	4.56	4.67	4.82	-	4.76	4.87	5.03	-	4.93	5.04	5.22	-					
		Amps	16.5	16.9	17.4	-	17.7	18.1	18.7	-	19.2	19.6	20.2	-	20.4	20.9	21.5	-	21.6	22.1	22.8	-	22.8	23.3	24.1	-					
		Hi PR	244	263	277	-	274	295	311	-	312	335	354	-	355	382	403	-	399	430	454	-	441	475	501	-					
	1700	Lo PR	102	109	119	-	108	115	126	-	112	120	131	-	118	126	137	-	124	132	144	-	128	136	149	-					
		MBh	59.7	61.5	66.6	71.5	58.4	60.1	65.0	69.8	57.0	58.7	63.5	68.1	55.6	57.2	61.9	66.5	52.8	54.4	58.8	63.2	48.9	50.4	54.5	58.5					
		S/T	0.80	0.71	0.54	0.35	0.83	0.74	0.56	0.36	0.85	0.76	0.58	0.37	0.88	0.78	0.59	0.38	0.91	0.81	0.62	0.40	0.92	0.82	0.62	0.40					
		ΔT	23	21	17	12	23	21	18	12	23	21	18	12	23	22	18	12	23	21	17	12	22	20	16	11					
		KW	3.90	3.98	4.11	4.25	4.21	4.30	4.44	4.59	4.48	4.58	4.74	4.90	4.72	4.83	4.99	5.17	4.93	5.04	5.21	5.39	5.11	5.22	5.40	5.59					
1504	Amps	17.1	17.5	18.0	18.6	18.4	18.8	19.3	20.0	19.8	20.3	20.9	21.7	21.1	21.6	22.3	23.1	22.4	22.9	23.6	24.5	23.6	24.2	25.0	25.9						
	Hi PR	254	274	289	301	285	307	324	338	324	349	369	384	369	398	420	438	416	447	472	493	459	494	522	544						
	Lo PR	107	113	124	132	113	120	131	139	117	125	136	145	123	131	143	152	129	137	150	159	133	142	155	165						
	MBh	58.0	59.7	64.6	69.4	56.7	58.3	63.1	67.8	55.3	56.9	61.6	66.2	54.0	55.6	60.1	64.5	51.3	52.8	57.1	61.3	47.5	48.9	52.9	56.8						
	S/T	0.76	0.68	0.52	0.33	0.79	0.71	0.53	0.34	0.81	0.72	0.55	0.35	0.84	0.75	0.57	0.36	0.87	0.78	0.59	0.38	0.88	0.78	0.59	0.38						
75	1700	ΔT	24	22	18	12	24	22	18	13	24	22	18	13	24	22	18	13	24	22	18	13	22	21	17	12					
		KW	3.87	3.95	4.08	4.22	4.17	4.27	4.41	4.56	4.44	4.54	4.70	4.86	4.68	4.79	4.95	5.12	4.89	5.00	5.17	5.35	5.06	5.18	5.35	5.54					
		Amps	16.9	17.3	17.8	18.4	18.2	18.6	19.2	19.8	19.7	20.1	20.7	21.5	20.9	21.4	22.1	22.9	22.2	22.7	23.4	24.3	23.4	24.0	24.7	25.6					
		Hi PR	252	271	286	298	282	304	321	335	321	346	365	381	366	394	416	434	412	443	468	488	455	489	517	539					
		Lo PR	106	112	123	131	111	119	129	138	116	123	135	143	122	129	141	151	128	136	148	158	132	140	153	163					
	1504	MBh	55.1	56.7	61.4	65.9	53.8	55.4	60.0	64.4	52.5	54.1	58.6	62.8	51.3	52.8	57.1	61.3	48.7	50.1	54.3	58.2	45.1	46.4	50.3	54.0					
		S/T	0.73	0.65	0.49	0.32	0.76	0.68	0.51	0.33	0.78	0.69	0.53	0.34	0.80	0.72	0.54	0.35	0.83	0.74	0.56	0.36	0.84	0.75	0.57	0.37					
		ΔT	25	23	19	13	25	23	19	13	25	23	19	13	25	23	19	13	25	23	19	13	23	21	17	12					
		KW	3.80	3.89	4.01	4.15	4.10	4.20	4.33	4.48	4.37	4.47	4.62	4.77	4.60	4.71	4.87	5.03	4.80	4.91	5.08	5.25	4.97	5.09	5.26	5.44					
		Amps	16.7	17.0	17.5	18.1	17.9	18.3	18.9	19.5	19.3	19.8	20.4	21.1	20.6	21.0	21.7	22.5	21.8	22.3	23.0	23.8	23.0	23.6	24.3	25.2					
1504	Hi PR	247	265	280	292	277	298	315	328	315	339	358	373	359	386	407	425	403	434	458	478	446	480	506	528						
	Lo PR	103	110	120	128	109	116	127	135	114	121	132	140	119	127	139	148	125	133	145	155	129	138	150	160						

IDB = Entering Indoor Dry Bulb Temperature
 High and low pressures are measured at the liquid and suction access fittings.
 Design Subcooling, 5-7 °F @ the liquid access fitting connection ARI 95 test conditions. Design Superheat 15-18°F @ the compressor suction access fitting connection.
 Shaded area reflects AHRl (TVA) conditions.
 Amps: Unit amps (comp.+ evaporator + condenser fan motors)
 KW = Total system power

IDB		OUTDOOR AMBIENT TEMPERATURE												ENTERING INDOOR WET BULB TEMPERATURE											
		65				75				85				95				105				115			
		59	63	67	71	59	63	67	71	59	63	67	71	59	63	67	71	59	63	67	71	59	63	67	71
1908	Mbh	60.8	62.1	66.4	71.0	59.4	60.7	64.8	69.3	58.0	59.2	63.3	67.7	56.6	57.8	61.8	66.0	53.7	54.9	58.7	62.7	49.8	50.9	54.3	58.1
	S/T	0.88	0.82	0.67	0.50	0.91	0.85	0.69	0.52	0.93	0.87	0.71	0.53	0.96	0.90	0.73	0.55	1.00	0.94	0.76	0.57	1.00	0.94	0.77	0.57
	ΔT	26	25	21	17	26	25	22	17	26	25	22	17	26	25	22	17	26	25	22	17	24	23	20	16
	KW	3.93	4.02	4.15	4.29	4.24	4.34	4.48	4.63	4.52	4.62	4.78	4.94	4.76	4.87	5.04	5.21	4.97	5.08	5.26	5.44	5.15	5.27	5.45	5.64
	Amps	17.2	17.6	18.1	18.8	18.5	18.9	19.5	20.2	20.0	20.5	21.1	21.8	21.3	21.8	22.5	23.3	22.6	23.1	23.8	24.7	23.8	24.4	25.2	26.1
	Hi PR	25.7	27.6	29.2	30.4	28.8	31.0	32.7	34.1	32.8	35.3	37.2	38.8	37.3	40.2	42.4	44.2	42.0	45.2	47.7	49.8	46.4	49.9	52.7	55.0
	Lo PR	108	115	125	133	114	121	132	141	118	126	137	146	124	132	144	154	130	138	151	161	135	143	156	167
	Mbh	59.0	60.3	64.5	68.9	57.7	58.9	63.0	67.3	56.3	57.5	61.5	65.7	54.9	56.1	60.0	64.1	52.2	53.3	57.0	60.9	48.3	49.4	52.8	56.4
	S/T	0.84	0.78	0.64	0.48	0.87	0.81	0.66	0.49	0.89	0.83	0.68	0.51	0.92	0.86	0.70	0.52	0.95	0.89	0.73	0.54	0.96	0.90	0.73	0.55
	ΔT	27	26	22	18	27	26	23	18	27	26	23	18	27	26	23	18	27	26	22	18	25	24	21	17
KW	3.90	3.98	4.11	4.25	4.21	4.30	4.44	4.59	4.48	4.58	4.74	4.90	4.72	4.83	4.99	5.17	4.93	5.04	5.21	5.39	5.11	5.22	5.40	5.59	
Amps	17.1	17.5	18.0	18.6	18.4	18.8	19.3	20.0	19.8	20.3	20.9	21.7	21.1	21.6	22.3	23.1	22.4	22.9	23.6	24.5	23.6	24.2	25.0	25.9	
Hi PR	25.4	27.4	28.9	30.1	28.5	30.7	32.4	33.8	32.4	34.9	36.9	38.5	37.0	39.8	42.0	43.8	41.6	44.7	47.2	49.3	45.9	49.4	52.2	54.4	
Lo PR	107	113	124	132	113	120	131	139	117	125	136	145	123	131	143	152	129	137	150	159	133	142	155	165	
Mbh	56.1	57.3	61.2	65.5	54.8	56.0	59.8	63.9	53.5	54.6	58.4	62.4	52.2	53.3	57.0	60.9	49.6	50.6	54.1	57.8	45.9	46.9	50.1	53.6	
S/T	0.80	0.75	0.61	0.46	0.83	0.78	0.63	0.47	0.85	0.80	0.65	0.49	0.88	0.82	0.67	0.50	0.91	0.86	0.70	0.52	0.92	0.86	0.70	0.52	
ΔT	27	26	23	18	28	27	23	19	28	27	23	19	28	27	23	19	28	26	23	18	26	25	21	17	
KW	3.84	3.92	4.05	4.18	4.14	4.23	4.37	4.52	4.41	4.51	4.66	4.81	4.64	4.75	4.91	5.08	4.84	4.95	5.12	5.30	5.02	5.13	5.31	5.49	
Amps	16.8	17.2	17.7	18.3	18.0	18.4	19.0	19.7	19.5	19.9	20.6	21.3	20.7	21.2	21.9	22.7	22.0	22.5	23.2	24.0	23.2	23.8	24.5	25.4	
Hi PR	24.9	26.8	28.3	29.5	28.0	30.1	31.8	33.1	31.8	34.2	36.1	37.7	36.2	39.0	41.2	42.9	40.7	43.8	46.3	48.3	45.0	48.4	51.1	53.3	
Lo PR	104	111	121	129	110	117	128	137	115	122	133	142	120	128	140	149	126	134	147	156	131	139	152	162	

Mbh	61.9	63.1	66.1	70.5	60.4	61.6	64.5	68.8	59.0	60.1	63.0	67.2	57.6	58.7	61.4	65.6	54.7	55.7	58.4	62.3	50.6	51.6	54.1	57.7
S/T	0.92	0.89	0.80	0.65	0.95	0.92	0.83	0.67	0.98	0.94	0.85	0.69	1.00	0.97	0.88	0.71	1.00	1.00	0.91	0.74	1.00	1.00	0.92	0.75
ΔT	27	27	25	22	28	27	26	22	28	27	26	22	28	28	28	23	26	27	26	22	24	25	24	21
KW	3.96	4.05	4.18	4.32	4.28	4.38	4.52	4.67	4.56	4.66	4.82	4.98	4.80	4.91	5.08	5.26	5.01	5.13	5.30	5.49	5.19	5.31	5.50	5.69
Amps	17.4	17.7	18.3	18.9	18.7	19.1	19.7	20.4	20.2	20.6	21.3	22.0	21.5	22.0	22.7	23.5	22.8	23.3	24.0	24.9	24.1	24.6	25.4	26.3
Hi PR	25.9	27.9	29.5	30.7	29.1	31.3	33.1	34.5	33.1	35.6	37.6	39.2	37.7	40.6	42.8	44.7	42.4	45.6	48.2	50.3	46.9	50.4	53.2	55.5
Lo PR	109	116	126	135	115	122	133	142	119	127	139	148	125	133	146	155	131	140	153	163	136	145	158	168
Mbh	60.1	61.2	64.1	68.4	58.7	59.8	62.6	66.8	57.3	58.4	61.1	65.2	55.9	57.0	59.7	63.6	53.1	54.1	56.7	60.5	49.2	50.1	52.5	56.0
S/T	0.88	0.85	0.76	0.62	0.91	0.88	0.79	0.64	0.93	0.90	0.81	0.66	0.96	0.93	0.84	0.68	1.00	0.96	0.87	0.71	1.00	0.97	0.88	0.71
ΔT	28	28	26	23	29	28	27	23	29	28	27	23	29	29	29	23	29	28	27	23	27	26	25	22
KW	3.93	4.02	4.15	4.29	4.24	4.34	4.48	4.63	4.52	4.62	4.78	4.94	4.76	4.87	5.04	5.21	4.97	5.08	5.26	5.44	5.15	5.27	5.45	5.64
Amps	17.2	17.6	18.1	18.8	18.5	18.9	19.5	20.2	20.0	20.5	21.1	21.8	21.3	21.8	22.5	23.3	22.6	23.1	23.8	24.7	23.8	24.4	25.2	26.1
Hi PR	25.7	27.6	29.2	30.4	28.8	31.0	32.7	34.1	32.8	35.3	37.2	38.8	37.3	40.2	42.4	44.2	42.0	45.2	47.7	49.8	46.4	49.9	52.7	55.0
Lo PR	108	115	125	133	114	121	132	141	118	126	137	146	124	132	144	154	130	138	151	161	135	143	156	167
Mbh	57.1	58.2	60.9	65.0	55.7	56.8	59.5	63.5	54.4	55.5	58.1	62.0	53.1	54.1	56.7	60.5	50.4	51.4	53.8	57.4	46.7	47.6	49.9	53.2
S/T	0.84	0.81	0.73	0.59	0.87	0.84	0.76	0.61	0.89	0.86	0.78	0.63	0.92	0.89	0.80	0.65	0.96	0.92	0.83	0.68	0.96	0.93	0.84	0.68
ΔT	29	29	27	24	30	29	28	24	30	29	28	24	30	29	28	24	29	29	27	24	28	27	26	22
KW	3.87	3.95	4.08	4.21	4.17	4.27	4.41	4.55	4.44	4.54	4.70	4.86	4.68	4.79	4.95	5.12	4.89	5.00	5.17	5.35	5.06	5.18	5.35	5.54
Amps	16.9	17.3	17.8	18.4	18.2	18.6	19.2	19.8	19.7	20.1	20.7	21.5	20.9	21.4	22.1	22.9	22.2	22.7	23.4	24.3	23.4	24.0	24.7	25.6
Hi PR	25.2	27.1	28.6	29.8	28.2	30.4	32.1	33.5	32.1	34.6	36.5	38.1	36.6	39.4	41.6	43.3	41.1	44.3	46.8	48.8	45.5	48.9	51.7	53.9
Lo PR	106	112	123	131	111	119	129	138	116	123	135	143	122	129	141	151	128	136	148	158	132	140	153	163

IDB = Entering Indoor Dry Bulb Temperature

High and low pressures are measured at the liquid and suction access fittings.

Design Subcooling, 5-7 °F @ the liquid access fitting connection ARI 95 test conditions. Design Superheat 15-18°F @ the compressor suction access fitting connection.

Shaded area reflects AHRI conditions.

Amps: Unit amps (comp.+ evaporator + condenser fan motors)

KW = Total system power

APH1624H41

	OUTDOOR AMBIENT TEMPERATURE																	
	65	60	55	50	47	45	40	35	30	25	20	17	15	10	5	0	-5	-10
MBh	28.7	27.1	25.5	23.9	22.8	22.1	20.5	18.9	16.2	15.0	13.8	13.0	12.5	11.2	10.0	8.7	7.4	6.1
T/R	30.3	28.7	27.0	25.3	24.1	23.4	21.7	20.0	17.1	15.8	14.6	13.8	13.2	11.9	10.5	9.2	7.8	6.4
kW	1.96	1.92	1.88	1.84	1.81	1.80	1.76	1.72	1.70	1.66	1.62	1.60	1.58	1.54	1.50	1.46	1.42	1.38
Amps	9.8	9.1	8.5	8.1	7.8	7.7	7.3	6.9	6.6	6.4	6.1	6.0	5.9	5.6	5.3	5.0	4.7	4.3
COP	4.28	4.14	3.98	3.80	3.68	3.60	3.42	3.23	2.78	2.63	2.48	2.38	2.32	2.13	1.94	1.74	1.53	1.29
HI PR	397	381	366	350	342	335	322	309	296	283	272	265	260	251	241	231	223	215
LO PR	140	129	121	111	105	101	93	83	75	67	59	55	53	44	38	32	28	22

APH1630H41

	OUTDOOR AMBIENT TEMPERATURE																	
	65	60	55	50	47	45	40	35	30	25	20	17	15	10	5	0	-5	-10
MBh	34.7	32.8	30.9	28.9	27.6	26.7	24.8	22.9	19.2	17.7	16.3	15.4	14.8	13.3	11.8	10.3	8.8	7.2
T/R	30.6	29.0	27.3	25.5	24.3	23.6	21.9	20.2	16.9	15.6	14.4	13.6	13.1	11.7	10.4	9.1	7.7	6.3
kW	2.37	2.32	2.27	2.22	2.19	2.17	2.13	2.08	2.03	1.98	1.94	1.91	1.89	1.84	1.79	1.74	1.69	1.64
Amps	11.7	10.9	10.2	9.7	9.3	9.2	8.7	8.3	7.9	7.6	7.3	7.1	7.0	6.7	6.3	6.0	5.6	5.1
COP	4.28	4.14	3.98	3.81	3.68	3.60	3.42	3.23	2.76	2.61	2.47	2.36	2.30	2.12	1.93	1.73	1.52	1.28
HI PR	408	391	376	359	351	344	331	318	304	291	279	272	268	257	247	237	229	221
LO PR	132	123	115	105	100	96	88	78	71	63	56	52	50	42	36	31	27	21

APH1636H41**

	OUTDOOR AMBIENT TEMPERATURE																	
	65	60	55	50	47	45	40	35	30	25	20	17	15	10	5	0	-5	-10
MBh	40.5	38.3	36.1	33.7	32.2	31.2	29.0	26.7	25.4	23.5	21.6	20.4	19.6	17.6	15.6	13.6	11.6	9.5
T/R	31.2	29.6	27.8	26.0	24.8	24.1	22.4	20.6	19.6	18.1	16.7	15.7	15.2	13.6	12.1	10.5	9.0	7.4
kW	2.84	2.78	2.73	2.67	2.64	2.61	2.56	2.50	2.52	2.46	2.40	2.37	2.35	2.29	2.23	2.18	2.12	2.06
Amps	14.1	13.1	12.3	11.7	11.3	11.1	10.5	10.1	9.7	9.3	8.9	8.7	8.6	8.2	7.8	7.4	6.9	6.3
COP	4.17	4.03	3.87	3.69	3.57	3.49	3.31	3.12	2.95	2.79	2.63	2.52	2.45	2.25	2.05	1.83	1.61	1.35
HI PR	391	375	360	344	336	330	317	304	291	278	267	261	256	246	237	227	219	211
LO PR	133	123	115	106	100	96	88	79	71	63	56	52	50	42	36	31	27	21

APH1636H41B*

	OUTDOOR AMBIENT TEMPERATURE																	
	65	60	55	50	47	45	40	35	30	25	20	17	15	10	5	0	-5	-10
MBh	40.5	38.3	36.1	33.7	32.2	31.2	29.0	26.7	24.5	22.7	20.9	19.7	19.0	17.0	15.1	13.2	11.2	9.2
T/R	31.2	29.6	27.8	26.0	24.8	24.1	22.4	20.6	18.9	17.5	16.1	15.2	14.6	13.1	11.6	10.2	8.7	7.1
kW	2.81	2.76	2.70	2.64	2.61	2.59	2.53	2.48	2.52	2.46	2.40	2.37	2.35	2.29	2.23	2.17	2.11	2.05
Amps	14.7	13.7	12.9	12.1	11.7	11.5	10.9	10.4	10.0	9.6	9.2	9.0	8.9	8.5	8.0	7.5	7.0	6.4
COP	4.21	4.07	3.91	3.73	3.61	3.53	3.35	3.16	2.85	2.69	2.54	2.43	2.37	2.18	1.98	1.77	1.56	1.31
EER	14.4	13.9	13.4	12.8	12.3	12.1	11.4	10.8	9.7	9.2	8.7	8.3	8.1	7.4	6.8	6.1	5.3	4.5
HI PR	385	369	355	339	331	325	312	300	287	274	263	257	252	243	233	224	216	208
LO PR	143	133	125	114	108	104	96	85	77	69	60	56	54	46	39	33	29	23

Above information is for nominal CFM and 70° indoor dry bulb. Instantaneous capacity listed.

AMPS: Unit amps (comp.+ evaporator motor + condenser fan motor)

High pressure is measured at the liquid line access fitting; low pressure is measured at the compressor suction access fitting.

kW = Total system power

APH1642H41A*

	OUTDOOR AMBIENT TEMPERATURE																	
	65	60	55	50	47	45	40	35	30	25	20	17	15	10	5	0	-5	-10
MBh	47.3	44.7	42.1	39.4	37.6	36.4	33.8	31.2	26.9	24.8	22.9	21.6	20.8	18.7	16.5	14.4	12.3	10.1
T/R	33.7	31.9	30.0	28.0	26.8	26.0	24.1	22.2	19.2	17.7	16.3	15.4	14.8	13.3	11.8	10.3	8.8	7.2
kW	3.25	3.18	3.12	3.05	3.02	2.99	2.93	2.86	2.85	2.79	2.72	2.69	2.66	2.59	2.53	2.46	2.40	2.33
Amps	16.5	15.4	14.5	13.7	13.2	13.0	12.3	11.7	11.3	10.8	10.4	10.2	10.0	9.6	9.0	8.6	8.0	7.3
COP	4.26	4.11	3.95	3.77	3.65	3.57	3.38	3.19	2.76	2.61	2.46	2.35	2.29	2.11	1.92	1.71	1.50	1.27
HI PR	395	379	364	348	340	333	320	308	295	281	270	264	259	249	240	230	222	214
LO PR	131	122	114	105	99	95	88	78	70	63	55	51	49	42	36	30	27	21

APH1642H41B*

	OUTDOOR AMBIENT TEMPERATURE																	
	65	60	55	50	47	45	40	35	30	25	20	17	15	10	5	0	-5	-10
MBh	52.1	49.4	46.4	43.4	41.5	40.2	37.3	34.4	30.3	27.9	25.7	24.3	23.4	21.0	18.6	16.2	13.9	11.3
T/R	36.5	34.5	32.5	30.4	29.0	28.1	26.1	24.1	21.2	19.6	18.0	17.0	16.4	14.7	13.0	11.4	9.7	7.9
kW	3.55	3.48	3.41	3.34	3.30	3.26	3.19	3.12	3.01	2.94	2.87	2.83	2.80	2.73	2.66	2.59	2.52	2.45
Amps	17.7	16.5	15.5	14.6	14.1	13.9	13.1	12.5	12.0	11.5	11.0	10.8	10.7	10.2	9.6	9.1	8.5	7.7
COP	4.29	4.15	3.99	3.81	3.68	3.60	3.42	3.23	2.94	2.78	2.63	2.52	2.45	2.25	2.05	1.83	1.61	1.36
EER	15	14	14	13	13	12	12	11	10	10	9	9	8	8	7	6	6	5
HI PR	403	386	371	355	347	340	327	314	301	287	276	269	264	254	244	234	226	218
LO PR	140	130	122	111	105	101	93	83	75	67	59	55	53	45	38	32	28	22

APH1648H41**

	OUTDOOR AMBIENT TEMPERATURE																	
	65	60	55	50	47	45	40	35	30	25	20	17	15	10	5	0	-5	-10
MBh	55.3	52.4	49.3	46.1	44.0	42.6	39.6	36.5	32.4	29.9	27.5	26.0	25.0	22.5	19.9	17.4	14.8	12.1
T/R	32.0	30.3	28.5	26.7	25.5	24.7	22.9	21.1	18.7	17.3	15.9	15.0	14.5	13.0	11.5	10.1	8.6	7.0
kW	3.74	3.66	3.59	3.51	3.47	3.44	3.36	3.29	3.33	3.25	3.17	3.13	3.10	3.02	2.94	2.86	2.78	2.71
Amps	18.8	17.5	16.5	15.6	15.1	14.8	14.1	13.4	12.9	12.4	11.9	11.6	11.5	11.0	10.4	9.8	9.2	8.5
COP	4.33	4.18	4.02	3.84	3.71	3.63	3.45	3.25	2.85	2.69	2.54	2.43	2.37	2.18	1.98	1.77	1.56	1.31
HI PR	382	366	352	337	329	323	310	298	285	272	261	255	251	241	232	222	214	207
LO PR	132	122	114	105	99	95	88	78	70	63	55	51	50	42	36	31	27	21

APH1660H41

	OUTDOOR AMBIENT TEMPERATURE																	
	65	60	55	50	47	45	40	35	30	25	20	17	15	10	5	0	-5	-10
MBh	71.5	67.6	63.7	59.5	56.8	55.1	51.2	47.2	42.1	38.8	35.8	33.8	32.5	29.2	25.9	22.6	19.3	15.8
T/R	38.9	36.8	34.7	32.4	31.0	30.0	27.9	25.7	22.9	21.2	19.5	18.4	17.7	15.9	14.1	12.3	10.5	8.6
kW	4.85	4.76	4.66	4.56	4.50	4.46	4.36	4.27	4.20	4.10	4.00	3.94	3.91	3.80	3.71	3.61	3.51	3.41
Amps	24.2	22.5	21.1	20.0	19.3	18.9	17.9	17.1	16.4	15.7	15.0	14.7	14.5	13.9	13.0	12.3	11.5	10.5
COP	4.31	4.16	4.00	3.82	3.70	3.61	3.43	3.24	2.93	2.77	2.62	2.51	2.44	2.24	2.04	1.83	1.61	1.35
HI PR	406	389	374	358	349	343	329	316	303	289	278	271	266	256	246	236	228	220
LO PR	128	118	111	102	96	92	85	76	68	61	54	50	48	41	35	30	26	20

Above information is for nominal CFM and 70° indoor dry bulb. Instantaneous capacity listed.

AMPS: Unit amps (comp.+ evaporator motor + condenser fan motor)

High pressure is measured at the liquid line access fitting; low pressure is measured at the compressor suction access fitting.

kW = Total system power

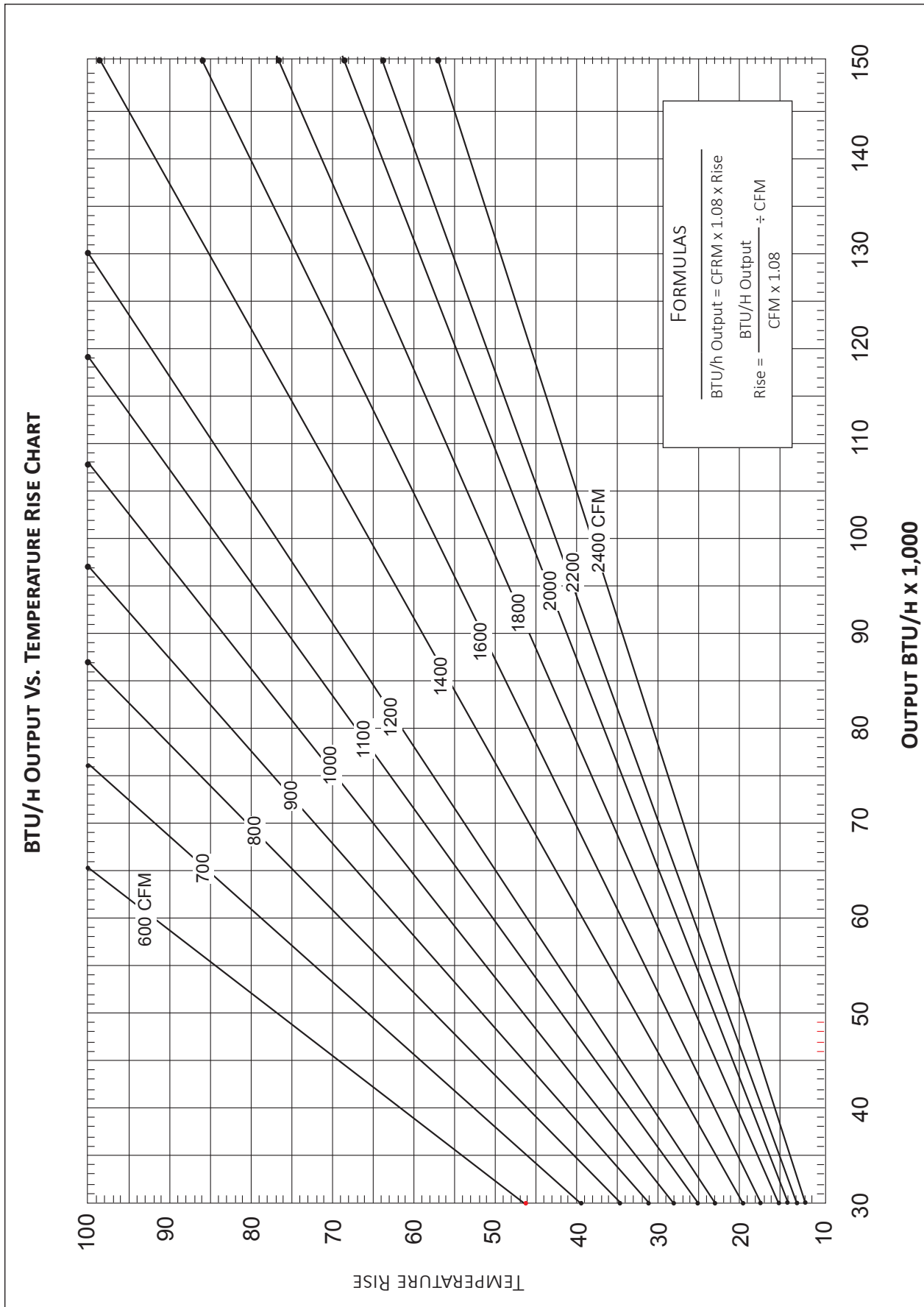

APH1624H41					
COOLING/ HP SPEED	ADJUST TAP	CFM*	ELECTRIC HEAT	ADJUST TAP	CFM*
D	Minus	858	D	Minus	858
	Normal	953		Normal	953
	Plus	1,048		Plus	1,048
C	Minus	800	C	Minus	800
	Normal	905		Normal	905
	Plus	986		Plus	986
B	Minus	743	B	Minus	743
	Normal**	847		Normal**	847
	Plus	939		Plus	939
A	Minus	714	A	Minus	714
	Normal	815		Normal	815
	Plus	903		Plus	903

* @ 0.1- 0.9 ESP **Factory Default is "B" Normal

APH1642H41A*					
COOLING/ HP SPEED	ADJUST TAP	CFM*	ELECTRIC HEAT	ADJUST TAP	CFM*
D	Minus	1,289	D	Minus	1,289
	Normal	1,392		Normal	1,392
	Plus	1,440		Plus	1,440
C	Minus	1,219	C	Minus	1,219
	Normal	1,323		Normal	1,323
	Plus	1,419		Plus	1,419
B	Minus	1,182	B	Minus	1,182
	Normal**	1,294		Normal**	1,294
	Plus	1,384		Plus	1,384
A	Minus	1,105	A	Minus	1,105
	Normal	1,219		Normal	1,219
	Plus	1,304		Plus	1,304

* @ 0.1- 0.9 ESP **Factory Default is "B" Normal

APH1630H41					
COOLING/ HP SPEED	ADJUST TAP	CFM*	ELECTRIC HEAT	ADJUST TAP	CFM*
D	Minus	969	D	Minus	969
	Normal	1,073		Normal	1,073
	Plus	1,180		Plus	1,180
C	Minus	930	C	Minus	930
	Normal**	1,032		Normal**	1,032
	Plus	1,135		Plus	1,135
B	Minus	834	B	Minus	834
	Normal	984		Normal	984
	Plus	1,101		Plus	1,101
A	Minus	833	A	Minus	833
	Normal	937		Normal	937
	Plus	1,036		Plus	1,036

* @ 0.1- 0.9 ESP **Factory Default is "B" Normal

APH1642H41B*					
COOLING/ HP SPEED	ADJUST TAP	CFM*	ELECTRIC HEAT	ADJUST TAP	CFM*
D	Minus	1,289	D	Minus	1,289
	Normal	1,392		Normal	1,392
	Plus	1,440		Plus	1,440
C	Minus	1,219	C	Minus	1,219
	Normal**	1,323		Normal**	1,323
	Plus	1,419		Plus	1,419
B	Minus	1,182	B	Minus	1,182
	Normal	1,294		Normal	1,294
	Plus	1,384		Plus	1,384
A	Minus	1,105	A	Minus	1,105
	Normal	1,219		Normal	1,219
	Plus	1,304		Plus	1,304

* @ 0.1- 0.9 ESP **Factory Default is "C" Normal

APH1636H41					
COOLING/ HP SPEED	ADJUST TAP	CFM*	ELECTRIC HEAT	ADJUST TAP	CFM*
D	Minus	1,135	D	Minus	1,135
	Normal	1,270		Normal	1,270
	Plus	1,371		Plus	1,371
C	Minus	1,042	C	Minus	1,042
	Normal	1,178		Normal	1,178
	Plus	1,307		Plus	1,307
B	Minus	932	B	Minus	932
	Normal**	1,065		Normal**	1,065
	Plus	1,181		Plus	1,181
A	Minus	823	A	Minus	823
	Normal	952		Normal	952
	Plus	1,080		Plus	1,080

* @ 0.1- 0.9 ESP **Factory Default is "B" Normal

APH1648H41					
COOLING/ HP SPEED	ADJUST TAP	CFM*	ELECTRIC HEAT	ADJUST TAP	CFM*
D	Minus	1,506	D	Minus	1,506
	Normal	1,699		Normal	1,699
	Plus	1,872		Plus	1,872
C	Minus	1,420	C	Minus	1,420
	Normal**	1,596		Normal**	1,596
	Plus	1,764		Plus	1,764
B	Minus	1,323	B	Minus	1,323
	Normal	1,491		Normal	1,491
	Plus	1,642		Plus	1,642
A	Minus	1,217	A	Minus	1,217
	Normal	1,385		Normal	1,385
	Plus	1,537		Plus	1,537

* @ 0.1- 0.9 ESP **Factory Default is "B" Normal

APH1660H41					
COOLING/ HP SPEED	ADJUST TAP	CFM*	ELECTRIC HEAT	ADJUST TAP	CFM*
D	Minus	1,506	D	Minus	1,506
	Normal**	1,699		Normal**	1,699
	Plus	1,872		Plus	1,872
C	Minus	1,420	C	Minus	1,420
	Normal	1,596		Normal	1,596
	Plus	1,764		Plus	1,764
B	Minus	1,323	B	Minus	1,323
	Normal	1,491		Normal	1,491
	Plus	1,642		Plus	1,642
A	Minus	1,217	A	Minus	1,217
	Normal	1,385		Normal	1,385
	Plus	1,537		Plus	1,537

* @ 0.1- 0.9 ESP **Factory Default is "D" Normal

HEAT KIT ELECTRICAL DATA (BLOWER ONLY, HEAT MODE)

MODEL AND HEAT KIT USAGE	CIRCUIT #1		CIRCUIT #2		SINGLE-POINT KIT		ACTUAL kW / BTU@ 240V
	MCA ¹	MOP ²	MCA ¹	MOP ²	MCA ¹	MOP ²	
APH1624H41**	4.3	---	---	---	--	--	---
HKP-05C*	21 / 25	25 / 25	---	---	46	50	4.75 / 16,200
HKR-08C*	32 / 36	35 / 40	---	---	58	60	7 / 23,800
HKP-10C*	43 / 49	45 / 50	---	---	71	80	9.5 / 32,400
APH1630H41**	4.3	---	---	---	--	--	---
HKP-05C*	21 / 25	25 / 25	---	---	48	50	4.75 / 16,200
HKR-08C*	32 / 36	35 / 40	---	---	60	60	7 / 23,800
HKP-10C*	43 / 49	45 / 50	---	---	73	80	9.5 / 32,400
HKP-15C*	43 / 49	45 / 50	21 / 25	25 / 25	97	100	14.25 / 48,600
APH1636H41**	4.3	---	---	---	--	--	---
HKP-05C*	21 / 25	25 / 25	---	---	51	60	4.75 / 16,200
HKR-08C*	32 / 36	35 / 40	---	---	63	70	7 / 23,800
HKP-10C*	43 / 49	45 / 50	---	---	76	80	9.5 / 32,400
HKP-15C*	43 / 49	45 / 50	21 / 25	25 / 25	101	110	14.25 / 48,600
APH1636H41BA	4.3	---	---	---	--	--	---
HKP-05C*	21 / 25	25 / 25	---	---	50	60	4.75 / 16,200
HKR-08C*	32 / 36	35 / 40	---	---	61.7	70	7 / 23,800
HKP-10C*	43 / 49	45 / 50	---	---	74.7	80	9.5 / 32,400
HKP-15C*	43 / 49	45 / 50	21 / 25	25 / 25	99.4	100	14.25 / 48,600
APH1636H41BB	4.3	---	---	---	--	--	---
HKP-05C*	21 / 25	25 / 25	---	---	50.3	60	4.75 / 16,200
HKR-08C*	32 / 36	35 / 40	---	---	62	70	7 / 23,800
HKP-10C*	43 / 49	45 / 50	---	---	75	80	9.5 / 32,400
HKP-15C*	43 / 49	45 / 50	21 / 25	25 / 25	99.7	100	14.25 / 48,600
APH1642H41**	4.3	---	---	---	--	--	---
HKP-05C*	21 / 25	25 / 25	---	---	53	60	4.75 / 16,200
HKR-08C*	32 / 36	35 / 40	---	---	65	70	7 / 23,800
HKP-10C*	43 / 49	45 / 50	---	---	78	80	9.5 / 32,400
HKP-15C*	43 / 49	45 / 50	21 / 25	25 / 25	102	110	14.25 / 48,600
HKP-20C	43 / 49	45 / 50	43 / 49	45 / 50	127	150	19.0 / 64,800
APH1648H41**	6.8	---	---	---	--	--	---
HKP-05C*	21 / 25	25 / 25	---	---	59	70	4.75 / 16,200
HKR-08C*	32 / 36	35 / 40	---	---	71	80	7 / 23,800
HKP-10C*	43 / 49	45 / 50	---	---	84	90	9.5 / 32,400
HKP-15C*	43 / 49	45 / 50	21 / 25	25 / 25	109	110	14.25 / 48,600
HKP-20C	43 / 49	45 / 50	43 / 49	45 / 50	134	150	19.0 / 64,800
APH1660H41**	6.8	---	---	---	--	--	---
HKP-05C*	21 / 25	25 / 25	---	---	59	70	4.75 / 16,200
HKR-08C*	32 / 36	35 / 40	---	---	71	80	7 / 23,800
HKP-10C*	43 / 49	45 / 50	---	---	84	90	9.5 / 32,400
HKP-15C*	43 / 49	45 / 50	21 / 25	25 / 25	109	110	14.25 / 48,600
HKP-20C	43 / 49	45 / 50	43 / 49	45 / 50	134	150	19.0 / 64,800

¹ Minimum Circuit Ampacity @ 208 / 240 V

² Maximum Overcurrent Protection Device @ 208 / 240 V

* Revision level that may or may not be designated

C Circuit breaker option

^ Heat Kit requires three-phase power supply

HKP-15C and HKP-20C replace HKR-15C and HKR-20C respectively to meet new UL1995 requirements.

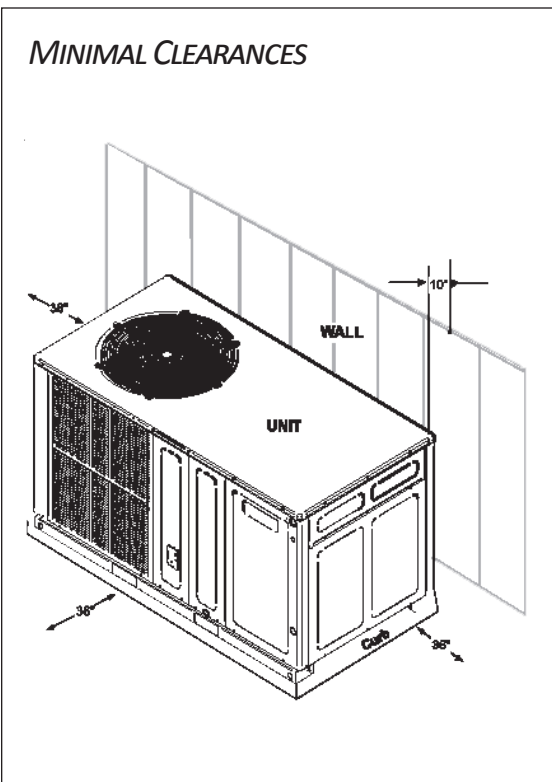
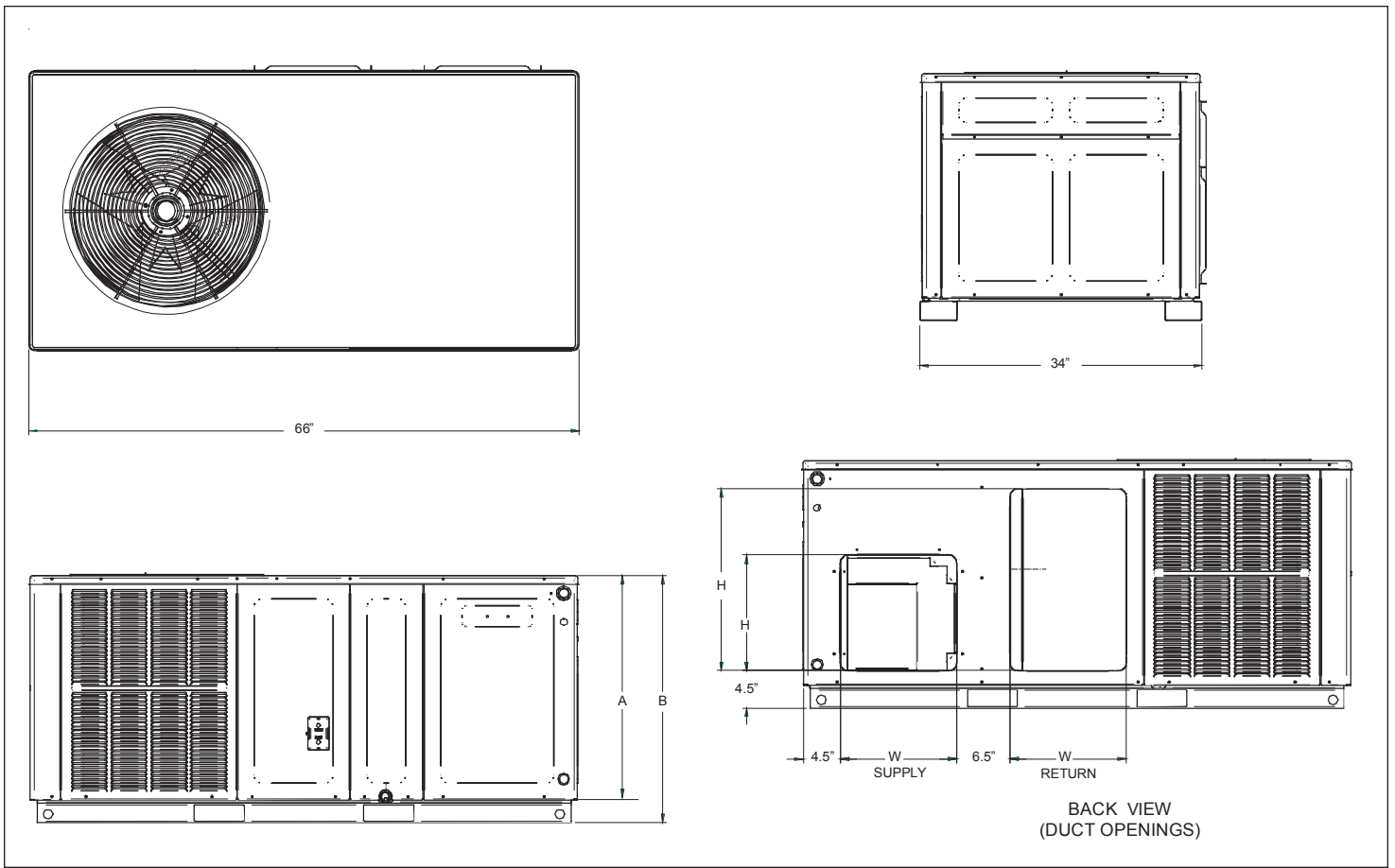

MODEL	UNIT DIMENSIONS				CHASSIS SIZE
			HEIGHT		
	W	D	A	B	
APH1624H41**	66	34	27½	30	Small
APH1630H41**	66	34	27½	30	Small
APH1636H41**	66	34	32½	35	Medium
APH1642H41**	66	34	32½	35	Medium
APH1648H41**	66	34	32½	35	Medium
APH1660H41**	66	34	36	38½	Large

MODEL	DUCT OPENINGS			
	SUPPLY		RETURN	
	W	H	W	H
APH1624H41**	14	14	14	22
APH1630H41**	14	14	14	22
APH1636H41**	14	14	14	24
APH1642H41**	14	14	14	24
APH1648H41**	14	14	14	24
APH1660H41**	14	14	14	24

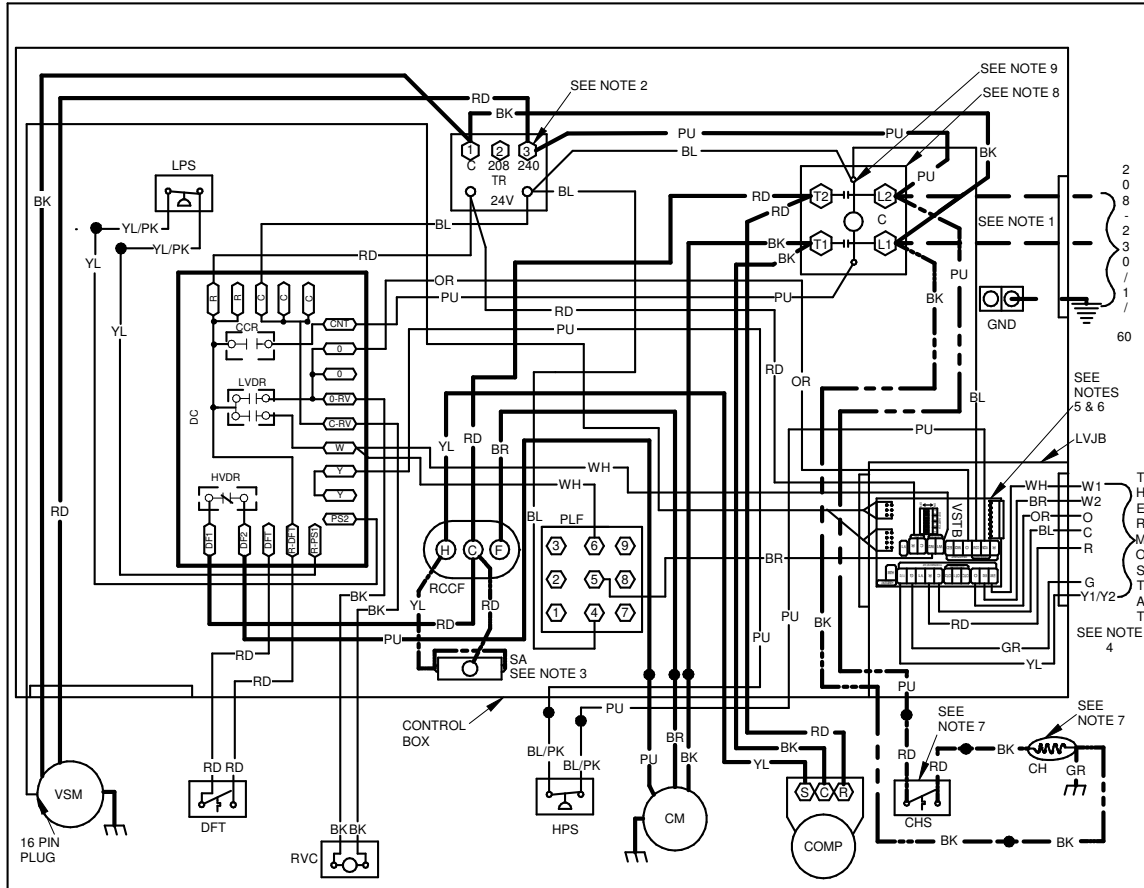

High Voltage: Disconnect all power before servicing or installing this unit. Multiple power sources may be present. Failure to do so may cause property damage, personal injury, or death.

WARNING

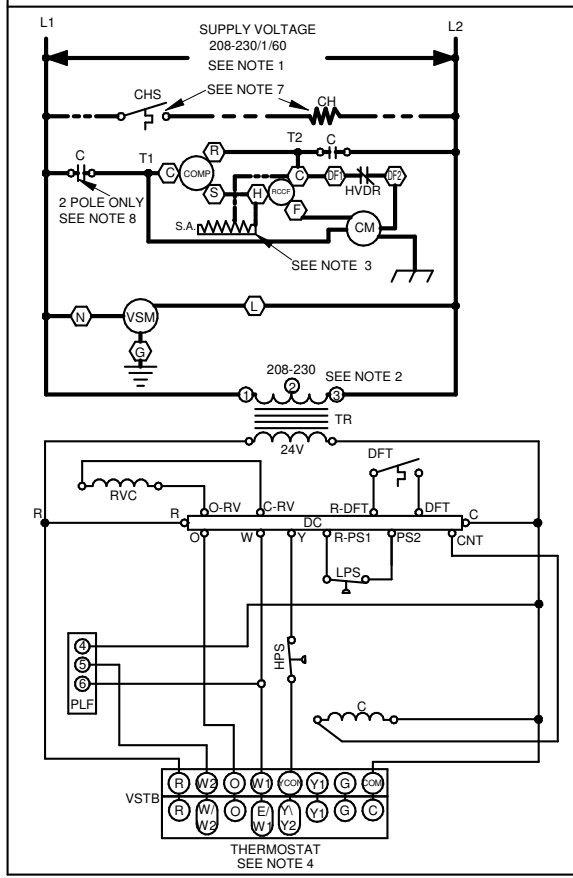

COMPONENT LEGEND		FACTORY WIRING	
C	CONTACTOR	—	LINE VOLTAGE
CCR	COMPRESSOR CONTACTOR RELAY	—	LOW VOLTAGE
CH	CRANKCASE HEATER	—	OPTIONAL HIGH VOLTAGE
CHS	CRANKCASE HEATER SWITCH		
CM	CONDENSER MOTOR		
COMP	COMPRESSOR		
CSR	COMPRESSOR SOLENOID RELAY		
DC	DEFROST CONTROL		
DFT	DEFROST THERMOSTAT		
GND	EQUIPMENT GROUND		
HPS	HIGH PRESSURE SWITCH		
HVDR	HIGH VOLTAGE DEFROST RELAY		
LPS	LOW PRESSURE SWITCH		
LVDR	LOW VOLTAGE DEFROST RELAY		
LVJB	LOW VOLTAGE JUNCTION BOX		
PLF	FEMALE PLUG / CONNECTOR		
RVC	REVERSING VALVE COIL		
RCCF	RUN CAPACITOR FOR COMPRESSOR AND FAN		
SA	START ASSIST		
SOL	HI STAGE SOLENOID		
TR	TRANSFORMER		
VSM	VARIABLE SPEED MOTOR		
VSTB	VARIABLE SPEED TERM BLOCK		

FIELD WIRING		WIRE CODE	
—	HIGH VOLTAGE	BK	BLACK
—	LOW VOLTAGE	BL	BLUE
		BR	BROWN
		GR	GREEN
		OR	ORANGE
		PU	PURPLE
		RD	RED
		WH	WHITE
		YL	YELLOW

EQUIPMENT GROUND		FIELD GROUND	
—	JUNCTION	—	FIELD SPLICE
—	TERMINAL	—	SWITCH (TEMP)
—	INTERNAL TO INTEGRATED CONTROL	—	IGNITER
—	PLUG CONNECTION	—	SWITCH (PRESS.)
		—	OVERCURRENT PROT. DEVICE

NOTES:

- REPLACEMENT WIRE MUST BE SAME SIZE AND TYPE INSULATION AS ORIGINAL (AT LEAST 105°C) USE COPPER CONDUCTOR ONLY.
- FOR 208 VOLT TRANSFORMER OPERATION MOVE PURPLE AND RED WIRES FROM TERMINAL 3 TO TERMINAL 2 ON TRANSFORMER.
- START ASSIST FACTOR EQUIPPED WHEN REQUIRED
- USE COPPER CONDUCTORS ONLY
- USE N.E.C. CLASS 2 WIRE
- SET DIP SWITCH 4 ON VSTB TO OFF POSITION
- REFER TO IO FOR FAN SPEED SETTINGS
- CRANKCASE HEATER AND CRANKCASE HEATER SWITCH FACTORY EQUIPPED WHEN REQUIRED.
- DOUBLE POLE CONTACTOR SHOWN. SINGLE POLE CONTACTOR COULD BE FACTORY EQUIPPED AS AN ALTERNATE CONFIGURATION.
- COMMON SIDE OF CONTACTOR CAN NOT BE GROUNDED OR CONNECTED TO ANY OTHER COMMON (24V).

SEE UNIT RATING PLATE FOR TYPE AND SIZE OF OVER CURRENT PROTECTION

Wiring is subject to change. Always refer to the wiring diagram or the unit for the most up-to-date wiring.

ACCESSORY DESCRIPTION	ITEM NUMBER	
	SMALL CHASSIS	MEDIUM/LARGE CHASSIS
Downflow Economizer (use w/PCCP roof curb)	DDNECNJPCHHA	DDNECNJPCHHA
Downflow Plenum Kit (use w/PCCP roof curb)	PCP101-103	PCP101-103
Downflow Plenum Kit (R-8) (use w/PCCP roof curb)	PCP101-103 R8	PCP101-103 R8
Elbow Flashing w/R-8 Liner	PCEF101-103	PCEF101-103
Economizer Wiring Harness (2- 3.5 Ton)	0259G00215	0259G00215
Economizer Wiring Harness (4- 5 Ton)	N/A	0259L00411
External Horizontal Filter Rack	DPHFRA	DPHFRA
Horizontal Economizer	DHZECNJPGCHM	DHZECNJPGCHM
Inline Fuse Kit	INFKPKG01	INFKPKG01
Isolation Relay Kit (req'd with Economizer)	IRKT-01	IRKT-01
Manual Damper (use with PCP101-103)	PCMD101-103	PCMD101-103
Manual Damper- Horizontal	GPHMD101-103	GPHMD101-103
Motorized Damper (use with PCP101-103)	PCMDM101-103	PCMDM101-103
Outdoor Thermostat & Emergency Heat Relay Kit	OT/EHR18-60	OT/EHR18-60
Outdoor Thermostat Kit w/ Lockout Stat	OT18-60A	OT18-60A
Roof Curb	PCCP101-103	PCCP101-103
Square to Round Downflow (use w/PCCP roof curb)	SQRPC101	SQRPC102-103
Square to Round Horizontal	SQRPCH101	SQRPCH102-103

SINGLE-POINT KIT ACCESSORY KITS

Select the single-point kit accessory based on the unit model.

MODEL	SINGLE-POINT KIT
APH1624H41**	SPK-30
APH1630H41**	SPK-35
APH1636H41**	SPK-40
APH1642H41**	SPK-45
APH1648H41**	SPK-50
APH1660H41**	SPK-60

