

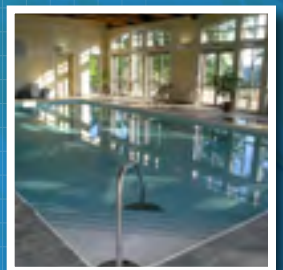

# ALL PRODUCTS BROCHURE

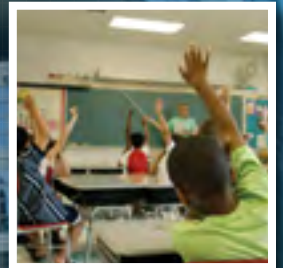

[www.AAON.com](http://www.AAON.com)

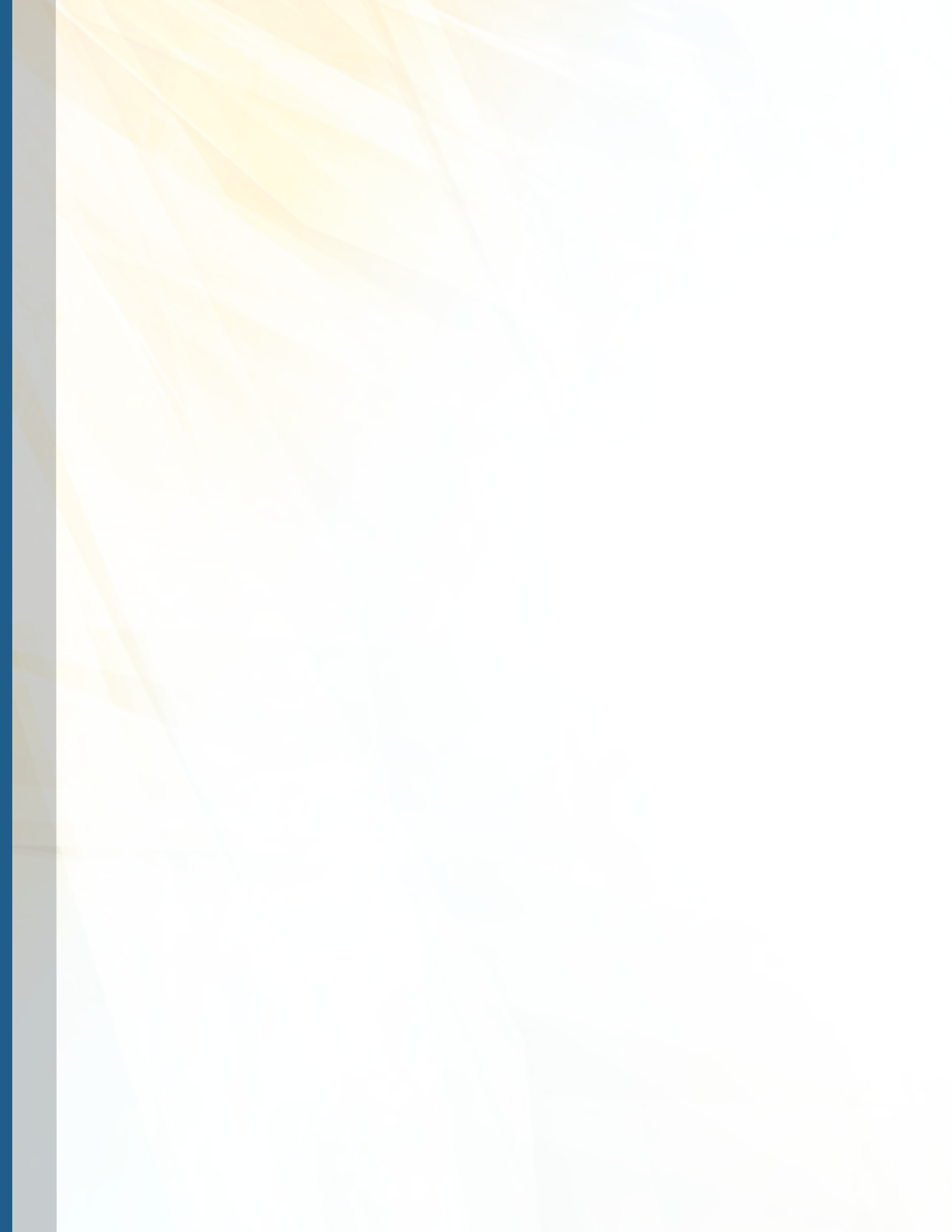

# DEDICATION TO CUSTOMER SERVICE



SINCE THE FOUNDING OF AAON IN 1988, WE HAVE MAINTAINED OUR COMMITMENT TO DESIGN, DEVELOP, MANUFACTURE AND DELIVER HEATING AND COOLING PRODUCTS TO PERFORM BEYOND ALL EXPECTATIONS AND DEMONSTRATE THEIR VALUE TO OUR CUSTOMERS. AAON UTILIZES EXTENSIVE PRODUCT KNOWLEDGE AND STATE OF THE ART MANUFACTURING TO CONTINUOUSLY PROVIDE PRACTICAL HVAC PRODUCTS TO THE DYNAMIC MARKETPLACE.

**FUNCTIONALITY** - AAON equipment is designed and manufactured to meet your particular requirements. AAON Sales Representatives can review with you the options available for each particular product type. Selection from the superior features and premier options, along with your choice of controls, will ensure the equipment is tailored exactly to the job specifications.

**ENERGY EFFICIENCY** - All AAON equipment is designed with the highest energy efficiency in mind. Efficiencies are maximized for all temperature conditions rather than only rated conditions. On applicable products, energy efficient designs are utilized like evaporative-cooled condensers and factory installed energy recovery devices.

**FACTORY TESTING** - All products, without exception, are run tested for all functions. All components are checked to ensure they function properly in the finished product. The refrigerant circuit is checked for high-pressure and low-pressure readings versus the ambient conditions to assure proper performance. The heating section is completely checked, including the rate of gas flow on gas heaters. Safety devices are checked by simulation of condenser fan or supply fan failure. Test results are recorded and copies of the results are shipped with the equipment.

**EASE OF INSTALLATION** - Complete factory installation and testing of all selected features and options eliminates the uncertainties and additional cost associated with field installation of add-on components. Our quality check procedure permits quick on-site installation and startup.

**EASE OF MAINTENANCE** - The increasing cost of qualified service technicians dictates the necessity to reduce the time to service all equipment. AAON equipment is designed from concept to completion with minimum service time as a primary factor. As an example, AAON utilizes doors with full height stainless steel hinges and lockable handles in all usual maintenance areas to minimize access time.

From a mechanical viewpoint, AAON designers understand the importance of accessible components to lower maintenance time and control associated cost. Readily accessible compressors and control components allow timely evaluation of service issues without delay. Color-coded wiring diagrams allow fast connection identification and analysis and thus a reduction in down time and cost. Individual components, wires, and fuses are also labeled for quick circuit evaluation. The result of this AAON standard procedure is low service cost and greater unit run time.



# TABLE OF CONTENTS

Custom & Cataloged Air Handling Units .....	11
M3 Series Modular Air Handling Units .....	12
M2 Series Modular Air Handling Units .....	16
SA Series Indoor Air Handling Units .....	20
H3/V3 Series Indoor Air Handling Units .....	24
F1 Series Indoor Air Handling Units .....	28
RL Series Outdoor Air Handling Units .....	30
RZ Series Outdoor Air Handling Units .....	34
RN Series Outdoor Air Handling Units .....	38
RQ Series Outdoor Air Handling Units .....	42
Condensers & Condensing Units .....	47
CN Series Condensers & Condensing Units .....	48
CF Series Condensers & Condensing Units .....	52
CB Series Condensers & Condensing Units .....	56
Chillers & Outdoor Mechanical Rooms .....	59
LZ Series Outdoor Mechanical Rooms .....	60
BL Series Boilers .....	68
FZ Series Fluid Cooler .....	70
LN Series Chillers .....	72
LF Series Chillers .....	76
Self-Contained Units .....	81
M2 Series Modular Self-Contained Units .....	82
SA Series Modular Self-Contained Units .....	86
SB Series Modular Self-Contained Units .....	90
WH/WV Water-Source Heat Pumps .....	94
Rooftop Units .....	97
RL Series Rooftop Units .....	98
RZ Series Rooftop Units .....	104
RN Series Rooftop Units .....	110
RQ Series Rooftop Units .....	116
Geothermal & Water-Source Heat Pumps .....	120
Air-Source Heat Pumps .....	123
Natatorium & Pool Room Units .....	125
Controls .....	127
AAON Touchscreen Controller .....	128
Wattmaster Orion Control Systems Controller .....	130
Micro Control Systems (MCS) Magnum Controller .....	132
AAON Jenesys Controller .....	134
Heating & Cooling Coils .....	139





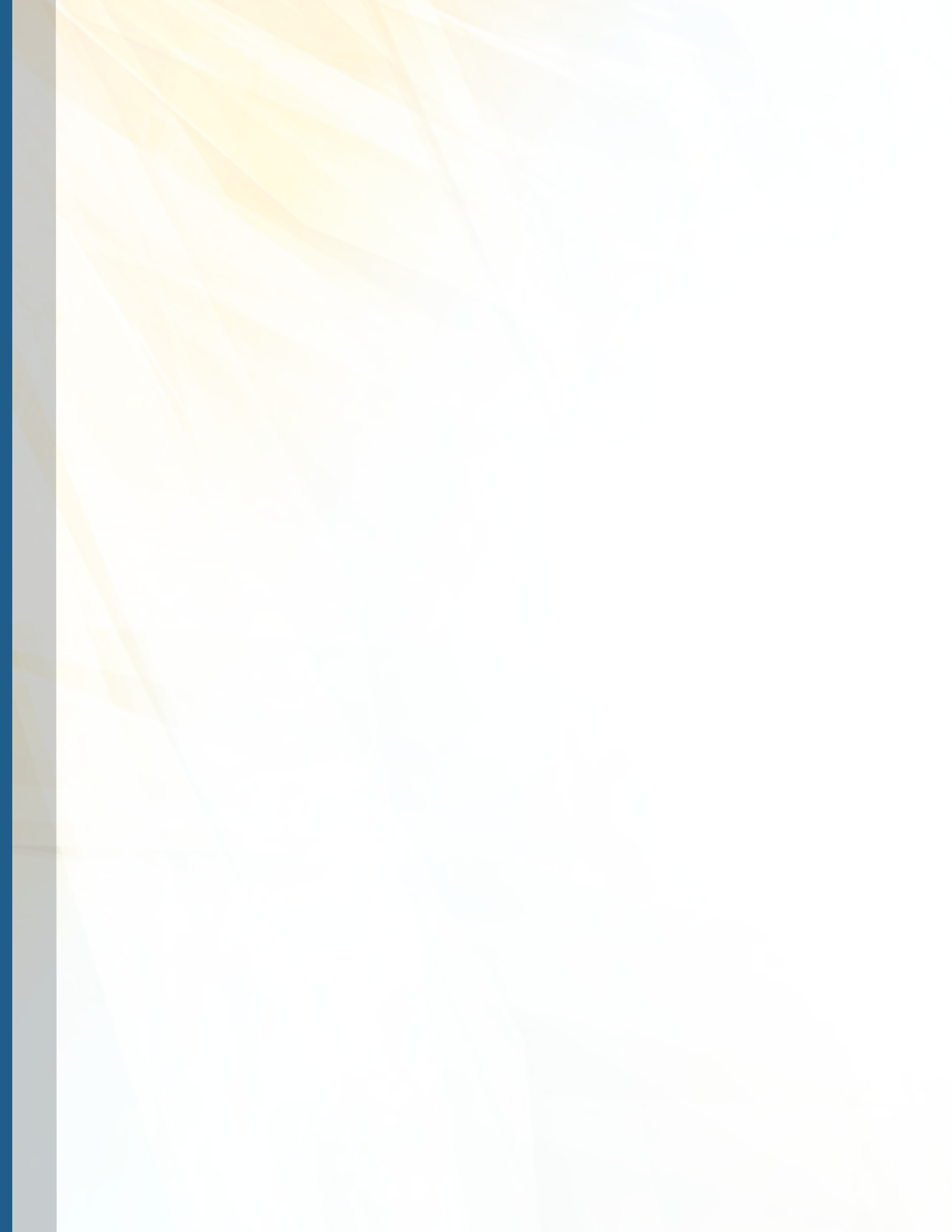

# AAON QUICK SELECTION

## Airflow (cfm)

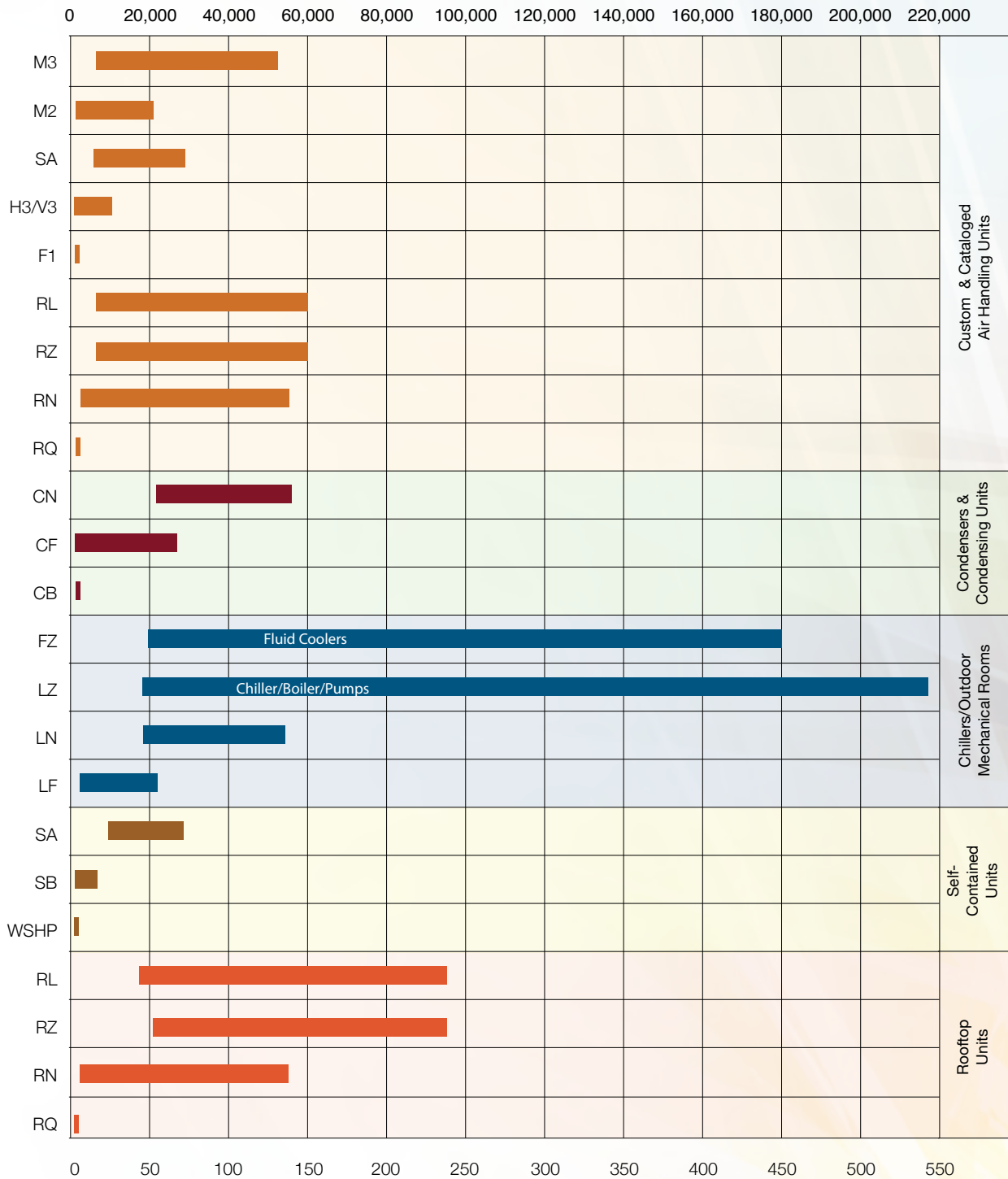

## Nominal Cooling (tons)



**Don't see the specific product you need?** AAON can meet your requirements with Custom Equipment designed specifically for your exact application and job specifications. Visit [www.aaon.com/repsearch](http://www.aaon.com/repsearch) or call 918.583.2266 to locate a representative near you.



# AAON PRODUCT FAMILY

## ROOFTOP UNITS



RZ/RL SERIES



RN SERIES



RQ SERIES

## PACKAGED OUTDOOR MECHANICAL ROOMS



BOILER MECHANICAL ROOM



LF SERIES



LN SERIES



FLUID COOLER



LZ SERIES

## SELF-CONTAINED UNITS



SB SERIES



SA SERIES



M2 SERIES

## INDOOR AIR HANDLING UNITS

F1 SERIES



H3 SERIES



V3 SERIES

SA SERIES



M2 SERIES



M3 SERIES

## OUTDOOR AIR HANDLING UNITS



RZ/RL SERIES



RN SERIES



RQ SERIES

## CONDENSING UNITS



CB SERIES



CF SERIES



CN SERIES

## COILS

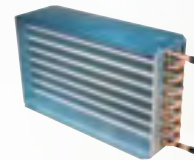

BOOSTER,  
HYDRONIC,  
& DX

## WATER-SOURCE HEAT PUMPS



VERTICAL & HORIZONTAL  
WSHP



RQ SERIES



RN SERIES



RZ/RL SERIES



M2 SERIES



SA SERIES



SB SERIES







**CUSTOM & CATALOGED  
AIR HANDLING UNITS**  
(Indoor & Outdoor)



AAON **M3 SERIES MODULAR INDOOR AND OUTDOOR AIR HANDLING UNITS** ARE ENGINEERED TO HANDLE MANY DIFFICULT APPLICATIONS. TOTAL ENERGY RECOVERY, 100% OUTSIDE AIR, AND SPECIAL DEHUMIDIFICATION NEEDS ARE JUST A FEW OF THE APPLICATIONS AAON M3 SERIES EASILY HANDLES. THROUGH DOUBLE WALL CONSTRUCTION AND ULTRA-LOW LEAKAGE RATES, AAON M3 SERIES AIR HANDLING UNITS PROVIDE ECONOMICAL SOLUTIONS FOR COMFORT COOLING AND HEATING.

### Applications

- Air handling unit with chilled water or direct expansion coils from 6,400 - 52,000 cfm.
- Heating from hot water, steam, indirect fired gas, direct fired gas and electric elements.
- Split system heat pump with air-source, water-source, or geothermal configurations.
- Makeup air capability, up to 100% outside air, to meet ventilation requirements.

### Construction

- The M3 Series modular design provides easy installation at the job site. Unit modules may be factory assembled to prevent unnecessary lifting at the job site or shipped separately for job site maneuverability.
- Double wall cabinets utilize thermal breaks and closed-cell polyurethane foam to increase thermal resistance, improve air seals, inhibit microbial growth, reinforce structural integrity, and attenuate radiated sound.
- Rigid polyurethane foam panels, high quality sealing, and double wall doors save operating costs by reducing the unfiltered and unconditioned air leakage to less than 1% system cfm at 8" static pressure.
- Selectable base rail height allows for condensate trapping and eliminates the need for a costly housekeeping pad.
- Double sloped, stainless steel drain pan eliminates standing water that can support microbial growth. A stainless steel drain pan inhibits corrosion that would normally contaminate the air stream.



▲ M3 Series indoor air handling unit split into modules.

### Fans and Blowers

- Fans and blowers are individually selected to match external static, sound, efficiency, and space design criteria as specified. Blowers are backward curved single thickness airfoil centrifugal plenum style. Blowers with backward curved blades are generally quieter and more efficient than forward curved blowers.
- Premium efficiency motors, direct drive systems, and variable speed fan control provide high efficiencies and significant operating cost savings.
- Supply fans, exhaust fans, and return fans are incorporated into fan arrays for redundancy, low turndown, and low noise capabilities.
- VFD controlled supply fans allow precise airflow control and reduced power consumption.



► Double wall rigid polyurethane foam panel construction increases thermal resistance, reduces air leakage and attenuates radiated noise.

- ◀ Backward curved fans are quiet, energy efficient and have high static pressure capabilities.

## Features and Options

- AAONAIRE® energy recovery is factory installed to reduce the operating expenses associated with supplying outside air to buildings. By reclaiming up to 80% of the exhaust air energy, AAONAIRE energy recovery units maintain comfortable temperatures and humidity during both cooling and heating conditions. AAONAIRE energy recovery wheels are rated to AHRI Standard 1060 and bear the AHRI Certification symbol.
- Pleated, permanent, cartridge, bag, and HEPA filters are available with or without monitoring devices to meet the building's required indoor air quality.
- UV-C lighting is also available inside the cabinet to meet even the most stringent indoor air quality requirements while increasing system performance and longevity by eliminating mold growth on coils.
- Coils are available with polymer e-coatings, copper fins, and stainless steel casings to minimize corrosion and improve air quality.
- Direct injection, gas-to-steam, dispersion tubes, and electric humidification systems can be factory installed to save installation time and complexity at the job site.
- Modulating hot gas reheat, reclaim coils, and return air bypass can provide the precise humidity control necessary to maintain occupant comfort.
- Cabinets can have custom interior and exterior paint to enhance aesthetics while improving corrosion resistance and indoor air quality.
- Electric and hot water preheat systems can be provided to prevent hydronic coil freezing.
- Cabinet walls are available in stainless steel for superior corrosion resistance or aluminum to decrease unit weight.
- Perforated, galvanized steel sound attenuators can be installed in the air stream to eliminate operational noise.



▲ Outdoor M3 Series air handling unit with factory installed inspection windows.

## Controls

- Unit wiring is completely factory provided with color-coded wires. Units are provided with specific, color-coded wiring diagrams. Diagrams are laminated and permanently affixed inside control compartment access door.
- Factory provided or customer provided controller can be selected to meet existing or new building control architecture.
- Factory run test and inspection reports are included in the documentation compartment affixed to the interior of the control compartment access door.



▲ Copper fins, stainless steel casing, and polymer e-coatings protect the coils from corrosion.



M3 Model	Nominal cfm	Width	Height	Length*
032	12,800	96	74	*Length will vary depending on options selected
039	15,600		87	
045	18,000		97	
054	21,600	112	107	
060	24,000		104	
067	26,800	126	138	
074	29,600	115		
083	33,200	127		
094	37,600			

All dimensions are in inches.

Design cfm may be 30-50% greater or less than nominal cfm.





# M3 Series

	032	039	045	054	060	067	074	083	094
<b>Cooling Options</b>									
Air Handling Unit - DX Coil	✓	✓	✓	✓	✓	✓	✓	✓	✓
Air Handling Unit - Chilled Water Coil	✓	✓	✓	✓	✓	✓	✓	✓	✓
Air Handling Unit - No Cooling	✓	✓	✓	✓	✓	✓	✓	✓	✓
<b>Heating Options</b>									
Electric Heat	✓	✓	✓	✓	✓	✓	✓	✓	✓
Natural Gas	✓	✓	✓	✓	✓	✓	✓	✓	✓
Natural Gas Modulating	✓	✓	✓	✓	✓	✓	✓	✓	✓
LP Gas	✓	✓	✓	✓	✓	✓	✓	✓	✓
Steam Distributing Coil	✓	✓	✓	✓	✓	✓	✓	✓	✓
Hot Water Coil	✓	✓	✓	✓	✓	✓	✓	✓	✓
<b>Unit Air Intake Options</b>									
Economizer	✓	✓	✓	✓	✓	✓	✓	✓	✓
Energy Recovery Wheel - Total or Sensible	✓	✓	✓	✓	✓	✓	✓	✓	✓
100% Outside Air Unit	✓	✓	✓	✓	✓	✓	✓	✓	✓
100% Return Air Unit	✓	✓	✓	✓	✓	✓	✓	✓	✓
<b>Serviceability Options</b>									
Convenience Outlet	✓	✓	✓	✓	✓	✓	✓	✓	✓
Remote Start/Stop Terminals	✓	✓	✓	✓	✓	✓	✓	✓	✓
Marine Service Lights	✓	✓	✓	✓	✓	✓	✓	✓	✓
Door Windows	✓	✓	✓	✓	✓	✓	✓	✓	✓
Treadplate Floor	✓	✓	✓	✓	✓	✓	✓	✓	✓
Shipping Splits	✓	✓	✓	✓	✓	✓	✓	✓	✓
<b>Filter Options</b>									
2" Pleated - 30% Efficient	✓	✓	✓	✓	✓	✓	✓	✓	✓
4" Pleated - 30% Efficient	✓	✓	✓	✓	✓	✓	✓	✓	✓
4" Cartridge - 65% Efficient - MERV 11	✓	✓	✓	✓	✓	✓	✓	✓	✓
4" Cartridge - 85% Efficient - MERV 13	✓	✓	✓	✓	✓	✓	✓	✓	✓
4" Cartridge - 95% Efficient - MERV 14	✓	✓	✓	✓	✓	✓	✓	✓	✓
12" Cartridge - 65% Efficient - MERV 11	✓	✓	✓	✓	✓	✓	✓	✓	✓
12" Cartridge - 85% Efficient - MERV 13	✓	✓	✓	✓	✓	✓	✓	✓	✓
12" Cartridge - 95% Efficient - MERV 14	✓	✓	✓	✓	✓	✓	✓	✓	✓
30" Bag - 65% Efficient - MERV 11	✓	✓	✓	✓	✓	✓	✓	✓	✓
30" Bag - 85% Efficient - MERV 13	✓	✓	✓	✓	✓	✓	✓	✓	✓
30" Bag - 95% Efficient - MERV 14	✓	✓	✓	✓	✓	✓	✓	✓	✓

# M3 Series

	032	039	045	054	060	067	074	083	094
<b>Safety Options</b>									
Return Air Firestat	✓	✓	✓	✓	✓	✓	✓	✓	✓
Supply Air Firestat	✓	✓	✓	✓	✓	✓	✓	✓	✓
Return Air Smoke Detector	✓	✓	✓	✓	✓	✓	✓	✓	✓
Supply Air Smoke Detector	✓	✓	✓	✓	✓	✓	✓	✓	✓
Phase and Brownout Protection	✓	✓	✓	✓	✓	✓	✓	✓	✓
<b>Control Options</b>									
Variable Air Volume (VAV)	✓	✓	✓	✓	✓	✓	✓	✓	✓
Constant Air Volume	✓	✓	✓	✓	✓	✓	✓	✓	✓
Single Zone VAV	✓	✓	✓	✓	✓	✓	✓	✓	✓
Makeup Air Unit	✓	✓	✓	✓	✓	✓	✓	✓	✓
Customer Provided Controls - Field Installed	✓	✓	✓	✓	✓	✓	✓	✓	✓
Customer Provided Controls - Factory Installed	✓	✓	✓	✓	✓	✓	✓	✓	✓
<b>Preheat Options</b>									
Steam Distributing Coil	✓	✓	✓	✓	✓	✓	✓	✓	✓
Hot Water Coil	✓	✓	✓	✓	✓	✓	✓	✓	✓
Electric Preheat	✓	✓	✓	✓	✓	✓	✓	✓	✓
<b>Construction Options</b>									
Burglar Bars	✓	✓	✓	✓	✓	✓	✓	✓	✓

## Available Modules

- Discharge Plenum Module**
- Heating Coil Module**
- Cooling/Preheat Coil Module**
- Supply Blower Module**
- Filter Module**
- Control Panel Module**
- Mixing Box/Economizer Module**
- Exhaust Fan Module**
- Energy Recovery Wheel Module**
- Return Fan Module**
- Blank Module**



AAON **M2 SERIES MODULAR INDOOR AIR HANDLING UNITS** UTILIZE QUALITY CONSTRUCTION TO PROVIDE LOW AIR LEAKAGE, MINIMAL RADIATED NOISE, AND SERVICEABILITY. THE MODULAR CABINET DESIGN ADAPTS TO COMPLEX ENGINEERING CHALLENGES, WHILE REMAINING EASY TO INSTALL AND SERVICE.

### Applications

- Air handling unit with chilled water or direct expansion coils from 1,000 - 21,600 cfm.
- Heating from hot water, steam, indirect fired gas, and electric elements.
- Split system heat pump with air-source, water-source, or geothermal configurations.
- Makeup air capability, up to 100% outside air, to meet ventilation requirements.
- Water-source heat pump module for geothermal applications, from 3 - 70 tons.

### Construction

- The M2 Series modular design provides easy installation at the job site. Unit modules may be factory assembled to prevent unnecessary lifting at the job site or shipped separately for job site maneuverability.
- Double wall cabinets utilize thermal breaks and closed-cell polyurethane foam to increase thermal resistance, improve air seals, inhibit microbial growth, reinforce structural integrity, and attenuate radiated sound.
- Rigid polyurethane foam panels, high quality sealing, and double wall doors save operating costs by reducing the unfiltered and unconditioned air leakage.
- Access into fan, filter, and coil sections is quick and easy through double wall rigid polyurethane foam panels. The panels have chrome plated steel hinges and quarter turn, zinc cast, lockable handles for effortless entry and removable hinge pins for access in compact spaces.
- Selectable base rail height allows for condensate trapping and eliminates the need for a costly housekeeping pad.
- Sloped stainless steel drain pans eliminate standing water which can support microbial growth and stainless steel construction prevents corrosion that could lead to water leaks and contaminants in the air stream.



▲ M2 Series indoor air handling unit with factory installed energy recovery wheel.

### Fans and Blowers

- Fans and blowers are individually selected to match external static, sound, efficiency, and space design criteria as specified. Blowers are backward curved single thickness airfoil centrifugal plenum style. Blowers with backward curved blades are generally quieter and more efficient than forward curved blowers.
- Premium efficiency motors, direct drive systems, and variable speed fan control provide the highest available efficiencies and operating cost savings.
- Electronically commutated motor driven or VFD controlled backward curved plenum fans are available to provide precise airflow control and reduced power consumption.
- Supply fans, exhaust fans, and return fans can be incorporated into fan arrays for redundancy, low turndown, and low noise capabilities.



- ▶ Double wall rigid polyurethane foam panel construction increases thermal resistance, reduces air leakage and attenuates radiated noise.



## Features and Options

- AAONAIRE energy recovery is factory installed to reduce the operating expenses associated with supplying outside air to buildings. By reclaiming up to 80% of the exhaust air energy, AAONAIRE energy recovery units maintain comfortable temperatures and humidity during both cooling and heating conditions. AAONAIRE energy recovery wheels are rated to AHRI Standard 1060 and bear the AHRI Certification symbol.
- Pleated and cartridge filters are available with or without monitoring devices to meet the building's required indoor air quality.
- UV-C lighting is available inside the cabinet to meet even the most stringent indoor air quality requirements while increasing system performance and longevity by eliminating mold growth on coils.
- Coils are available with polymer e-coatings, copper fins, and stainless steel casings to minimize corrosion and improve air quality.
- Modulating hot gas reheat can provide the precise humidity control necessary to maintain occupant comfort without the temperature swings common with on/off systems.
- Cabinets can have custom interior and exterior paint to enhance aesthetics while improving corrosion resistance and indoor air quality.
- Electric and hot water preheat systems can be provided to prevent hydronic coil freezing.



▲ Factory installed indirect fired gas heater provides energy efficient heating.

## Controls

- Unit wiring is completely factory provided with color-coded wires. Units are provided with unit specific, color-coded wiring diagrams. Diagrams are laminated and permanently affixed inside control compartment access door.
- Factory provided or customer provided controller can be selected to meet existing or new building control architecture.
- Factory run test and inspection reports are included in the documentation compartment affixed to the interior of the control compartment access door.



▲ Multiple filtration options are available on the M2 Series.

M2 Model	Nominal cfm	Width (inches)	Height (in) Single Level	Height (in) Dual Level	Length (inches)
005	2,000	50	32	66	Length may vary depending on options selected
008	3,500		44	90	
011	4,500	62	48	98	
014	6,500		54	110	
018	8,000	84	48	98	
022	11,500		54	110	
026	13,500		64	130	
032	16,500	96	70	142	
036	18,500				

All dimensions are in inches.

Design cfm may be up to 35% greater than nominal cfm.



**Don't see the specific product you need?** AAON can meet your requirements with Custom Equipment designed specifically for your exact application and job specifications. Visit [www.aaon.com/repsearch](http://www.aaon.com/repsearch) or call 918.583.2266 to locate a representative near you.



# M2 Series

	005	008	011	014	018	022	026	032	036
<b>Cooling Options</b>									
Air Handling Unit - DX Coil	✓	✓	✓	✓	✓	✓	✓	✓	✓
Air Handling Unit - Chilled Water Coil	✓	✓	✓	✓	✓	✓	✓	✓	✓
Air Handling Unit - No Cooling	✓	✓	✓	✓	✓	✓	✓	✓	✓
<b>Heating Options</b>									
Electric Heat	✓	✓	✓	✓	✓	✓	✓	✓	✓
Steam Distributing Coil	✓	✓	✓	✓	✓	✓	✓	✓	✓
Hot Water Coil	✓	✓	✓	✓	✓	✓	✓	✓	✓
Natural Gas	✓	✓	✓	✓	✓	✓	✓	✓	✓
LP Gas	✓	✓	✓	✓	✓	✓	✓	✓	✓
Air-Source Heat Pump	✓	✓	✓	✓	✓	✓	✓	✓	✓
Water-Source/Geothermal Heat Pump	✓	✓	✓	✓	✓	✓	✓	✓	✓
<b>Refrigeration Options</b>									
Modulating Hot Gas Reheat	✓	✓	✓	✓	✓	✓	✓	✓	✓
<b>Unit Air Intake Options</b>									
Economizer	✓	✓	✓	✓	✓	✓	✓	✓	✓
Energy Recovery Wheel - Total or Sensible	✓	✓	✓	✓	✓	✓	✓	✓	✓
100% Outside Air Unit	✓	✓	✓	✓	✓	✓	✓	✓	✓
100% Return Air Unit	✓	✓	✓	✓	✓	✓	✓	✓	✓
<b>Serviceability Options</b>									
Magnehelic Gauge/ Clogged Filter Switch	✓	✓	✓	✓	✓	✓	✓	✓	✓
Convenience Outlet	✓	✓	✓	✓	✓	✓	✓	✓	✓
Shipping Splits	✓	✓	✓	✓	✓	✓	✓	✓	✓
Non-fused Disconnect	✓	✓	✓	✓	✓	✓	✓	✓	✓
Service Lights	✓	✓	✓	✓	✓	✓	✓	✓	✓

## Available Modules

- Fan Module**
- Filter Module**
- Mixing Box Module**
- Heating Module**
- Cooling Module**
- Blank Module**
- Controls Module**
- Energy Recovery Module**
- Water-Source Heat Pump Module**

# M2 Series

	005	008	011	014	018	022	026	032	036
<b>Filter Options</b>									
2" Pleated - 30% Efficient - MERV 10	✓	✓	✓	✓	✓	✓	✓	✓	✓
4" Pleated - 30% Efficient - MERV 10	✓	✓	✓	✓	✓	✓	✓	✓	✓
4" Pleated - 65% Efficient - MERV 11	✓	✓	✓	✓	✓	✓	✓	✓	✓
4" Pleated - 85% Efficient - MERV 13	✓	✓	✓	✓	✓	✓	✓	✓	✓
4" Pleated - 95% Efficient - MERV 14	✓	✓	✓	✓	✓	✓	✓	✓	✓
12" Cartridge - 65% Efficient - MERV 11	✓	✓	✓	✓	✓	✓	✓	✓	✓
12" Cartridge - 85% Efficient - MERV 13	✓	✓	✓	✓	✓	✓	✓	✓	✓
12" Cartridge - 95% Efficient - MERV 14	✓	✓	✓	✓	✓	✓	✓	✓	✓
<b>Safety Options</b>									
Return Air Firestat	✓	✓	✓	✓	✓	✓	✓	✓	✓
Supply Air Firestat	✓	✓	✓	✓	✓	✓	✓	✓	✓
Return Air Smoke Detector	✓	✓	✓	✓	✓	✓	✓	✓	✓
Phase and Brownout Protection	✓	✓	✓	✓	✓	✓	✓	✓	✓
<b>Control Options</b>									
Variable Air Volume (VAV)	✓	✓	✓	✓	✓	✓	✓	✓	✓
Constant Air Volume	✓	✓	✓	✓	✓	✓	✓	✓	✓
Single Zone VAV	✓	✓	✓	✓	✓	✓	✓	✓	✓
Makeup Air	✓	✓	✓	✓	✓	✓	✓	✓	✓
Remote Start/Stop Terminals	✓	✓	✓	✓	✓	✓	✓	✓	✓
Customer Provided Controls - Field Installed	✓	✓	✓	✓	✓	✓	✓	✓	✓
Customer Provided Controls - Factory Installed	✓	✓	✓	✓	✓	✓	✓	✓	✓
<b>Preheat Options</b>									
Steam Distributing Coil	✓	✓	✓	✓	✓	✓	✓	✓	✓
Hot Water Coil	✓	✓	✓	✓	✓	✓	✓	✓	✓
Electric Preheat	✓	✓	✓	✓	✓	✓	✓	✓	✓
<b>Supply Fan Options</b>									
VFD Controlled Backward Curved Plenum Supply Fan	✓	✓	✓	✓	✓	✓	✓	✓	✓
ECM Driven Backward Curved Plenum Supply Fan	✓	✓	✓	✓					
Dual Fan Configuration								✓	✓
<b>Coil Options</b>									
E-Coated	✓	✓	✓	✓	✓	✓	✓	✓	✓
Copper Fins	✓	✓	✓	✓	✓	✓	✓	✓	✓
Stainless Steel Casing	✓	✓	✓	✓	✓	✓	✓	✓	✓
High Pressure Water Coils (400 psi)	✓	✓	✓	✓	✓	✓	✓	✓	✓
UV Lights	✓	✓	✓	✓	✓	✓	✓	✓	✓



AAON **SA SERIES INDOOR AIR HANDLING UNITS** LEAD THE INDUSTRY IN CONSTRUCTION AND PERFORMANCE. VERTICAL CONFIGURATION, DIRECT DRIVE BACKWARD CURVED PLENUM SUPPLY FANS, AND DOUBLE WALL RIGID POLYURETHANE FOAM INSULATED CABINET CONSTRUCTION PROVIDE THE SA SERIES WITH UNMATCHED PERFORMANCE.

### Applications

- Chilled water or non-compressorized DX air handling unit, from 5,300 - 27,000 cfm.
- Vertical self-contained unit with a water-cooled condenser or match with a remote air-cooled condenser, from 23 - 70 tons.
- Air-source, water-source, or geothermal heat pump configurations.
- Makeup air capability, up to 100% outside air, to meet ventilation requirements.
- High performance hot water or steam heating coils allow unit to tie into a boiler system.



▶ SA Series Single Cabinet Chilled Water Air Handling Unit



◀ SA Series Dual Cabinet Unit

### Construction

- Two-inch double wall rigid polyurethane foam panel cabinet construction has a thermal resistance of R-13 or greater, which exceeds the R-value of a cabinet with four-inch thick fiberglass construction. Panels include a thermal break, with no metal contact from inside to outside, to prevent heat transfer through the panel and prevent condensation on the outside of the cabinet. The inner wall protects the insulation from moisture damage, prevents microbial growth, and is easy to clean. This type of construction also makes the cabinet more rigid and resistant to damage, provides increased sound dampening, and reduces air leakage and infiltration.
- Access doors with full length stainless steel piano hinges and quarter turn, zinc cast, lockable handles provide improved reliability over single point hinges and plastic or sheet metal handles, and make the unit easily serviceable.
- Modular design with compact footprint makes the SA Series ideal for retrofit applications.
- Corrosion resistant exterior polyurethane paint exceeds a 2,500 hour salt spray test.
- Double sloped stainless steel drain pans eliminate standing water which can support microbial growth and stainless steel construction prevents corrosion that could lead to water leaks and contaminants in the air stream.



#### Don't see the specific product you need?

AAON can meet your requirements with Custom Equipment designed specifically for your exact application and job specifications. Visit [www.aaon.com/repsearch](http://www.aaon.com/repsearch) or call 918.583.2266 to locate a representative near you.

### Fans and Blowers

- Spring isolated direct drive backward curved plenum fans are more energy efficient, quieter, and require less maintenance than belt driven fans. These single thickness airfoil plenum blowers are quieter and more energy efficient than forward curved blowers.
- Single or multiple supply air connections can be factory provided from the right, left, back, or top sides of the supply fan plenum.
- VFD controlled supply fans allow precise airflow control and reduced power consumption.



### Controls

- Labeled electrical components and color-coded wiring match the unit specific color-coded wiring diagram which is laminated and permanently affixed inside the control compartment.
- Factory provided or customer provided controller can be selected to meet existing or new building control architecture.
- Unit controls are contained within single compartment isolated from the air stream for ease of service and quiet operation.
- Factory run test report, wiring diagram, and Installation, Operation, and Maintenance manual with startup form are provided in the control compartment of every unit.

### Features and Options

- Split system modulating humidity control is available to provide energy efficient dehumidification, even with low sensible heat loads, without the temperature swings common with on/off reheat systems.
- Multiple high efficiency filtration options, with up to a MERV 14 efficiency rating.
- Polymer e-coated coils are available to extend the life of the coils and protect them in corrosive environments.
- Interior corrosion protection option protects interior components of the unit in corrosive environments.

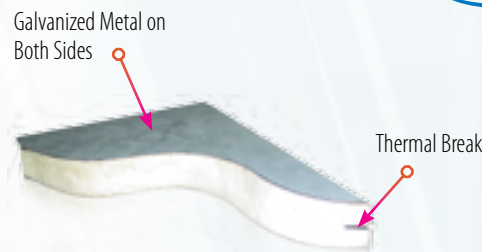

▲ Rigid polyurethane foam panel construction provides increased sound dampening and reduces air leakage and infiltration.

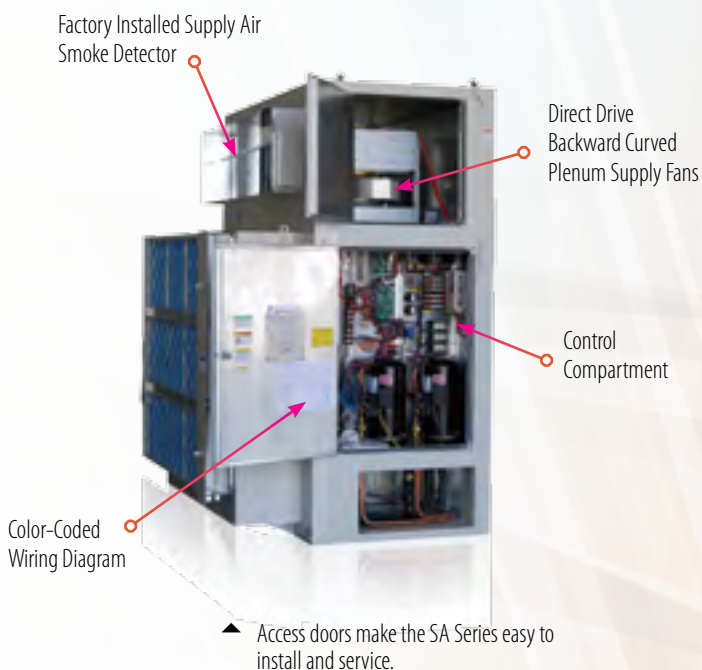

▲ Access doors make the SA Series easy to install and service.

SA Model	Intake	Nominal cfm	Width*	Height*	Length
023	Single	6,900	55	111-135 (in 4 inch increments)	79
028		8,400			
030		9,000			
035		10,500			
045	Double	13,500	110**		
050		15,000			
055		16,500			
058		17,400			
060		18,000			
065		19,500			
070		21,000			



\*Dimensions may vary depending on options selected.  
 \*\*Double intake units can be split in half for ease of installation.  
 All dimensions are in inches.  
 Design cfm may be 30-50% greater or less than nominal cfm.





# SA Series

	023	028	030	035	045	050	055	058	060	065	070
<b>Cooling Options</b>											
Air Handling Unit - DX Coil	✓	✓	✓	✓	✓	✓	✓	✓	✓	✓	✓
Air Handling Unit - Chilled Water Coil	✓	✓	✓	✓	✓	✓	✓	✓	✓	✓	✓
<b>Heating Options</b>											
Air-Source Heat Pump	✓	✓	✓	✓	✓	✓	✓	✓	✓	✓	✓
Steam Distributing Coil	✓	✓	✓	✓	✓	✓	✓	✓	✓	✓	✓
Hot Water Coil	✓	✓	✓	✓	✓	✓	✓	✓	✓	✓	✓
<b>Refrigeration Options</b>											
Modulating Hot Gas Reheat	✓	✓	✓	✓	✓	✓	✓	✓	✓	✓	✓
<b>Unit Air Intake Options</b>											
100% Outside Air Unit	✓	✓	✓	✓	✓	✓	✓	✓	✓	✓	✓
100% Return Air Unit	✓	✓	✓	✓	✓	✓	✓	✓	✓	✓	✓
<b>Serviceability Options</b>											
Convenience Outlet	✓	✓	✓	✓	✓	✓	✓	✓	✓	✓	✓
Lockable, Hinged Doors	✓	✓	✓	✓	✓	✓	✓	✓	✓	✓	✓
Clogged Filter Switch/Magnehelic Gauge	✓	✓	✓	✓	✓	✓	✓	✓	✓	✓	✓
<b>Filter Options</b>											
2" Pleated - 30% Efficient - MERV 8	✓	✓	✓	✓	✓	✓	✓	✓	✓	✓	✓
4" Pleated - 30% Efficient - MERV 8	✓	✓	✓	✓	✓	✓	✓	✓	✓	✓	✓
4" Pleated - 65% Efficient - MERV 11	✓	✓	✓	✓	✓	✓	✓	✓	✓	✓	✓
4" Pleated - 85% Efficient - MERV 13	✓	✓	✓	✓	✓	✓	✓	✓	✓	✓	✓
4" Pleated - 95% Efficient - MERV 14	✓	✓	✓	✓	✓	✓	✓	✓	✓	✓	✓

# SA Series

	023	028	030	035	045	050	055	058	060	065	070
<b>Safety Options</b>											
Condensate Overflow Switch	✓	✓	✓	✓	✓	✓	✓	✓	✓	✓	✓
Return Air Smoke Detector	✓	✓	✓	✓	✓	✓	✓	✓	✓	✓	✓
Supply Air Smoke Detector	✓	✓	✓	✓	✓	✓	✓	✓	✓	✓	✓
Freeze Stat	✓	✓	✓	✓	✓	✓	✓	✓	✓	✓	✓
<b>Control Options</b>											
Variable Air Volume (VAV)	✓	✓	✓	✓	✓	✓	✓	✓	✓	✓	✓
Constant Air Volume	✓	✓	✓	✓	✓	✓	✓	✓	✓	✓	✓
Single Zone VAV	✓	✓	✓	✓	✓	✓	✓	✓	✓	✓	✓
Makeup Air	✓	✓	✓	✓	✓	✓	✓	✓	✓	✓	✓
Remote Start/Stop Terminals	✓	✓	✓	✓	✓	✓	✓	✓	✓	✓	✓
Customer Provided Controls - Field Installed	✓	✓	✓	✓	✓	✓	✓	✓	✓	✓	✓
Customer Provided Controls - Factory Installed	✓	✓	✓	✓	✓	✓	✓	✓	✓	✓	✓
<b>Preheat Options</b>											
Steam Distributing Coil	✓	✓	✓	✓	✓	✓	✓	✓	✓	✓	✓
Hot Water Coil	✓	✓	✓	✓	✓	✓	✓	✓	✓	✓	✓
<b>Construction Options</b>											
Multiple Plenum Fan Heights	✓	✓	✓	✓	✓	✓	✓	✓	✓	✓	✓
Plenum Fan Sound Attenuation	✓	✓	✓	✓	✓	✓	✓	✓	✓	✓	✓
Shipping Splits	✓	✓	✓	✓	✓	✓	✓	✓	✓	✓	✓
Forkliftable Base	✓	✓	✓	✓	✓	✓	✓	✓	✓	✓	✓



AAON **H3/V3 SERIES INDOOR AIR HANDLING UNITS** ARE DESIGNED AND ENGINEERED FOR A WIDE VARIETY OF HEATING, COOLING, DEHUMIDIFYING, FILTERING, AND VENTILATING APPLICATIONS. AAON DOUBLE WALL RIGID POLYURETHANE FOAM PANEL CONSTRUCTION AND BACKWARD CURVED PLENUM SUPPLY FANS PROVIDE A QUIET, ENERGY EFFICIENT, AIR HANDLING UNIT.

### Applications

- Air handling unit with chilled water or direct expansion coils from 450 - 10,000 cfm.
  - High performance hot water, steam, and electric heating.
  - Split system heat pump configurations.
  - Makeup air capability, up to 100% outside air, to meet ventilation requirements.
  - Single Zone VAV applications reduce sound levels and energy consumption and ultimately save money.
- Double sloped stainless steel drain pans eliminate standing water which can support microbial growth and stainless steel construction prevents corrosion that could lead to water leaks and contaminants in the air stream. The drain pan connection is based on the unit's right or left configuration for installation flexibility.
  - Access into fan and coil sections is quick and easy through double wall rigid polyurethane foam panels with quarter turn, lockable handles for effortless entry. The fan section also has removable hinge pins for access in compact spaces.

### Construction

- The H3 Series indoor air handling unit is designed with an extremely low horizontal profile for overhead and low clearance installations, while the V3 Series indoor air handling unit is designed for small closets or mechanical rooms and narrow clearances.
- Double wall rigid polyurethane foam panel cabinet construction has a thermal resistance of R-6.5. Panels include a thermal break, with no metal contact from inside to outside, to prevent heat transfer through the panel and prevent condensation on the outside of the cabinet. The inner wall protects the insulation from moisture damage, prevents microbial growth, and is easy to clean. This type of construction also makes the cabinet more rigid and resistant to damage, provides increased sound dampening, and reduces air leakage and infiltration.
- AMCA Certified low leakage gear driven economizer dampers are standard on H3/V3 Series mixing boxes. AAON low leakage dampers meet the California Title 24 damper air leakage requirement.

### Fans and Blowers

- Direct drive variable speed fans are utilized to create an economical, high efficiency system that reduces operating expenses.
- Fans and blowers are individually selected to match external static, sound, efficiency, and space design criteria as specified. Blowers are backward curved single thickness airfoil centrifugal plenum style. Blowers with backward curved blades are generally quieter and more efficient than forward curved blowers. Their sturdy construction makes them suitable for applications with higher static pressure requirements.
- Electronically commutated motor driven backward curved plenum fans are available to provide precise airflow control and reduced power consumption.



▲ H3 Series Horizontal Air Handling Unit

Easy service access is provided to coils, fan, filters and heater. ▶

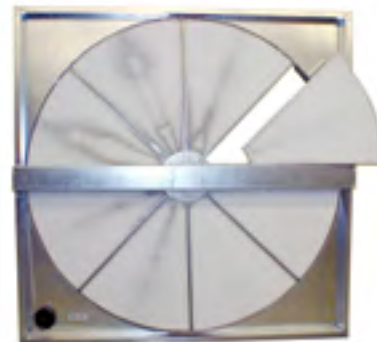

▲ Factory Installed AAON AIRE® energy recovery wheel saves heating and cooling energy.

## Features and Options

- Multiple high efficiency filtration options, with up to a MERV 14 efficiency rating.
- Coils are available with polymer e-coatings, copper fins, and stainless steel casings to minimize corrosion and improve air quality.
- Modulating hot gas reheat can provide the precise humidity control necessary to maintain occupant comfort.
- Cabinets can have custom interior and exterior paint to enhance aesthetics while improving corrosion resistance and indoor air quality.
- Hot water preheat systems can be provided to prevent hydronic coil freezing.
- Electric heat systems can include Silicon Controlled Rectifier (SCR) control for reduced power consumption, longer heater life, and improved occupant comfort.
- Steam distributing coils reduce the opportunity for condensation freezing in the steam heating coil.
- Factory installed mixing boxes with gear driven outside air and return air dampers allow for airside economizer free cooling.
- Factory installed total or sensible AAONAIRE energy recovery wheels save cooling and heating dollars.

## Controls

- Unit wiring is completely factory provided with color-coded wires. Units are provided with unit specific, color-coded wiring diagrams. Diagrams are laminated and permanently affixed inside control compartment access door.
- Factory provided or customer provided controller can be selected to meet existing or new building control architecture.
- Factory run test and inspection reports are included in the documentation compartment affixed to the interior of the control compartment access door.
- VAV and Single Zone VAV configurations to minimize operating costs.

## Ease of Installation

- Air handling units are designed to fit through 36 inch wide by 80 inch tall doors for ease of installation and retrofit applications. E cabinet units may be shipped from the factory in a split configuration.



◀ Direct drive backward curved plenum fans are quiet, energy efficient, and have high static pressure capabilities.

▶ V3 Series Vertical Air Handling Unit



H3/V3 Model	cfm	H3			V3		
		Width	Height	Length*	Width	Height*	Length*
A	450-1,200	30	22	56	30	42	32
B	1,000-2,000	42			52		
C	1,800-4,000	60	27		42	72	
D	3,000-6,000	84	34	59	56	72	34
E	5,200-10,000	100				92	56

\*Dimensions may vary depending on options selected.  
All dimensions are in inches.



# H3/V3 Series

	A Cabinet	B Cabinet	C Cabinet	D Cabinet	E Cabinet
<b>Cooling Options</b>					
Air Handling Unit - DX Coil	✓	✓	✓	✓	✓
Air Handling Unit - Chilled Water Coil	✓	✓	✓	✓	✓
<b>Heating Options</b>					
Electric Heat	✓	✓	✓	✓	✓
Steam Distributing Coil	✓	✓	✓	✓	✓
Hot Water Coil	✓	✓	✓	✓	✓
Air-Source Heat Pump	✓	✓	✓	✓	✓
<b>Refrigeration Options</b>					
Modulating Hot Gas Reheat	✓	✓	✓	✓	✓
<b>Unit Air Intake Options</b>					
Economizer	✓	✓	✓	✓	✓
Up to 100% Outside Air Unit	✓	✓	✓	✓	✓
Up to 100% Return Air Unit	✓	✓	✓	✓	✓
Energy Recovery Wheel - Total or Sensible	V3	V3	V3	V3	V3
<b>Serviceability Options</b>					
Magnehelic Gauge/ Clogged Filter Switch	✓	✓	✓	✓	✓
Non-fused Disconnect	✓	✓	✓	✓	✓
Forkliftable Base	V3	V3	V3	V3	V3
Convenience Outlet	✓	✓	✓	✓	✓
Service Lights	✓	✓	✓	✓	✓
Shipping Splits	✓	✓	✓	✓	✓
<b>Filter Options</b>					
2" Pleated - 30% Efficient	✓	✓	✓	✓	✓
4" Pleated - 30% Efficient	✓	✓	✓	✓	✓
4" Pleated - 65% Efficient - MERV 11	✓	✓	✓	✓	✓
4" Pleated - 85% Efficient - MERV 13	✓	✓	✓	✓	✓
4" Pleated - 95% Efficient - MERV 14	✓	✓	✓	✓	✓
2" Pleated - 30% Eff + 4" Pleated - Up to 95% Efficient - MERV 14	✓	✓	✓	✓	✓
Final Filter	H3	H3	H3	H3	H3



# H3/V3 Series

	A Cabinet	B Cabinet	C Cabinet	D Cabinet	E Cabinet
<b>Safety Options</b>					
Return Air Firestat	✓	✓	✓	✓	✓
Supply Air Firestat	✓	✓	✓	✓	✓
Return Air Smoke Detector	✓	✓	✓	✓	✓
Phase and Brownout Protection	✓	✓	✓	✓	✓
<b>Control Options</b>					
Variable Air Volume	✓	✓	✓	✓	✓
Constant Air Volume	✓	✓	✓	✓	✓
Single Zone VAV	✓	✓	✓	✓	✓
Makeup Air Unit	✓	✓	✓	✓	✓
Remote Start/Stop Terminals	✓	✓	✓	✓	✓
Customer Provided - Field Installed	✓	✓	✓	✓	✓
Customer Provided - Factory Installed	✓	✓	✓	✓	✓
<b>Preheat Options</b>					
Steam Distributing Coil	✓	✓	✓	✓	✓
Hot Water Coil	✓	✓	✓	✓	✓
Electric Preheat	V3	V3	V3		
<b>Supply Fan Options</b>					
ECM Driven Direct Drive Backward Curved Plenum Supply Fan	✓	✓	✓	✓	✓
Dual Fan Configuration			H3	✓	✓
<b>Coil Options</b>					
E-Coated	✓	✓	✓	✓	✓
Copper Fins	✓	✓	✓	✓	✓
Stainless Steel Casing	✓	✓	✓	✓	✓
High Pressure Water Coils (400 psi)	✓	✓	✓	✓	✓
UV Lights	✓	✓	✓	✓	✓
<b>Power Options</b>					
Dual Point Power	✓	✓	✓	✓	✓



AAON **F1 SERIES INDOOR AIR HANDLING UNITS** CAN BE USED FOR RESIDENTIAL OR LIGHT COMMERCIAL APPLICATIONS. DURABLE STEEL CONSTRUCTION, EFFICIENT OPERATION, AND EASY SERVICE ACCESS ARE SOME OF THE MANY REASONS THAT HOMEOWNERS AND LIGHT COMMERCIAL CUSTOMERS WILL ENJOY AAON SPLIT SYSTEMS.

### Applications

- Air handling unit with direct expansion coils from 800 - 2,000 cfm.
- Heating from hot water coils and electric elements.
- Split system heat pump configurations.

### Construction

- The F1 Series indoor air handling unit is designed for multi-position applications. The unit may be positioned with a vertical (upflow) or horizontal orientation as required by the installation.
- Rigid galvanized construction and foil faced insulation provide a sturdy and dependable air handling unit that promotes indoor air quality.
- The sloped corrosion resistant drain pan eliminates standing water that can support microbial growth. The drain pan will not corrode and contaminate the air stream. The drain pan connections are positioned in multiple locations for installation flexibility.

### Fans and Blowers

- Variable speed fans are included to create a high efficiency system that reduces initial and operating expenses.



▲ F1 Series multi-position indoor air handling unit with matching CB or CF Series condensing unit.

### Features and Options

- Units include thermal expansion valves to simplify installation and improve reliability.
- The F1 Series air handling unit can improve occupant comfort by precisely controlling humidity through the modulating hot gas reheat system.
- Units are capable of heat pump operation to provide an energy efficient heating system.
- Indoor air quality is maintained through 1 inch filters. Filters can be easily replaced through the unit's filter access panel.

### Controls

- Unit wiring is completely factory provided with color-coded wires. Units are provided with specific unit color-coded wiring diagrams. Diagrams are laminated and permanently affixed inside control compartment access door.
- Factory run test and inspection reports are included with the unit.



▶ F1 Series multi-position indoor air handling unit with modulating hot gas reheat humidity control option.

F1 Model	Nominal cfm	Width	Height*	Length
024	800	22	51	21
036	1,200			
048	1,600	26	59	22
060	2,000			

\*Dimensions may vary depending on options selected. All dimensions are in inches. Design cfm may be 30-50% greater or less than nominal cfm.

# F1 Series

	024	036	048	060
<b>Cooling Options</b>				
Air Handling Unit - DX Coil - A-coil design	✓	✓	✓	✓
<b>Heating Options</b>				
Electric Heat	✓	✓	✓	✓
Hot Water Coil	✓	✓	✓	✓
Air-Source Heat Pump	✓	✓	✓	✓
<b>Refrigeration Options</b>				
Modulating Hot Gas Reheat	✓	✓	✓	✓
<b>Unit Air Intake Options</b>				
Vertical Position - Upflow	✓	✓	✓	✓
Multi-Position - Upflow or Horizontal	✓	✓	✓	✓
<b>Filter Options</b>				
1" Pleated - 30% Efficient - MERV 8	✓	✓	✓	✓
<b>Control Options</b>				
Standard Terminal Block	✓	✓	✓	✓
<b>Supply Fan Options</b>				
ECM Direct Drive Fan	✓	✓	✓	✓



**Don't see the specific product you need?** AAON can meet your requirements with Custom Equipment designed specifically for your exact application and job specifications. Visit [www.aaon.com/repsearch](http://www.aaon.com/repsearch) or call 918.583.2266 to locate a representative near you.



AAON **RL SERIES OUTDOOR AIR HANDLING UNITS** SET THE STANDARD FOR LARGE COMMERCIAL OUTDOOR AIR HANDLING UNITS IN CUSTOMIZATION, PERFORMANCE, AND SERVICEABILITY. DOUBLE WALL RIGID POLYURETHANE FOAM INSULATED CABINET CONSTRUCTION AND AN ARRAY OF DRAW-THROUGH OR BLOW-THROUGH DIRECT DRIVE BACKWARD CURVED PLENUM FANS ALLOW RL SERIES UNITS TO HAVE QUIET, ENERGY EFFICIENT AIRFLOW WITH HIGH STATIC PRESSURE CAPABILITIES.

### Applications

- Chilled water or non-compressorized DX air handling unit, from 6,000 - 75,000 cfm.
- Packaged rooftop unit with an air-cooled, water-cooled, or evaporative-cooled condenser, from 45 - 240 tons.
- Available as an air-source, water-source, or geothermal heat pump.
- Makeup air capability, up to 100% outside air, to meet ventilation requirements.
- High performance hot water, steam, electric and indirect/direct fired gas heating.

### Construction

- Two-inch double wall rigid polyurethane foam panel cabinet construction has a thermal resistance of R-13 or greater, which exceeds the R-value of a cabinet with four-inch thick fiberglass construction. Panels include a thermal break, with no metal contact from inside to outside, to prevent heat transfer through the panel and prevent condensation on the outside of the cabinet. The inner wall protects the insulation from moisture damage, prevents microbial growth, and is easy to clean. This type of construction also makes the cabinet more rigid and resistant to damage, provides increased sound dampening, and reduces air leakage and infiltration.
- Access doors with full length stainless steel piano hinges and quarter turn, zinc cast, lockable handles provide improved reliability over single point hinges and plastic or sheet metal handles, and make the unit easily serviceable.
- Aluminum tread plate flooring is included in equipment access areas for improved durability and safety.
- Corrosion resistant exterior polyurethane paint exceeds a 2,500 hour salt spray test.
- Double sloped stainless steel drain pans eliminate standing water which can support microbial growth and stainless steel construction prevents corrosion that could lead to water leaks and contaminants in the air stream.



▲ RL Series Air Handling Unit

### Fans and Blowers

- Spring isolated direct drive backward curved plenum fans are more energy efficient, quieter, and require less maintenance than belt driven fans. These single thickness airfoil plenum blowers are quieter and more energy efficient than forward curved blowers.
- Selectable number of draw-through or blow-through direct drive backward curved plenum fans allows design flexibility for quieter applications and applications where unit uptime is critical.
- VFD controlled supply, exhaust, and return fans for precise airflow control, building pressure control, and reduced power consumption.



▲ Direct Drive Axial Flow Exhaust/Return Fans are more energy efficient and require less maintenance than belt driven fans.



### Controls

- Labeled electrical components and color-coded wiring match the unit specific color-coded wiring diagram which is laminated and permanently affixed inside the control compartment.
- Factory provided or customer provided controller can be selected to meet existing or new building control architecture.
- Unit controls are contained within a walk-in service compartment isolated from the air stream for ease of service and quiet operation. Service compartment can be independently heated.
- Run test report, color-coded wiring diagram, and Installation, Operation and Maintenance manual with startup form are included in control access compartment of every unit.



◀ Spring isolated direct drive backward curved plenum fans are more efficient, have higher static pressure capacities and require less maintenance than belt driven, forward curved fans.

### Features and Options

- Split system modulating humidity control is available to provide energy efficient dehumidification, even with low sensible heat loads, without the temperature swings common with on/off reheat systems.
- High efficiency, multiple stage, gas and electric heating are available to meet job requirements.
- Factory installed, sensible or enthalpy, gear driven economizer allows for free cooling.
- Multiple high efficiency filtration options, including pleated, cartridge, or bag type, with up to a MERV 14 efficiency rating.
- Factory installed total and sensible AAONAIRE® energy recovery wheels save cooling and heating dollars. Return fans are available for high return static applications.
- Polymer e-coated coils are available to extend the life of the coils and protect them in corrosive environments.
- Interior corrosion protection option protects interior components of the unit in corrosive environments.



▲ Factory installed AAONAIRE energy recovery wheels save heating and cooling energy.

RL Model	Nominal cfm	Width	Height	Length*
045	15,000	100	102	225
060	18,000			
070	20,000			
075	21,000			233
095	22,000			
100	26,000			
110	26,000	142	102	223
125	28,500			
134	33,000	100	142	223
135	30,000	142		
155	36,000			
170	38,500			227
190	43,000			
210	45,000			
230	47,000			

\*Dimension may vary depending on options selected.  
 All dimensions are in inches.  
 Design cfm may be 30-50% greater or less than nominal cfm.





# RL Series

Air Handling Units (6,000 - 75,000 cfm)	
<b>Cooling Options</b>	
Air Handling Unit - No Cooling	✓
Air Handling Unit - DX Coil	✓
Air Handling Unit - Chilled Water Coil	✓
<b>Heating Options</b>	
Electric Heat	✓
Natural Gas	✓
Steam Distributing Coil	✓
Hot Water Coil	✓
<b>Refrigeration Options</b>	
Modulating Hot Gas Reheat	✓
<b>Unit Air Intake Options</b>	
Economizer	✓
Energy Recovery Wheel - Total or Sensible	✓
100% Outside Air Unit	✓
<b>Serviceability Options</b>	
Factory Wired Convenience Outlet	✓
Service Lights	✓
<b>Filter Options</b>	
2" Pleated - 30% Efficient - MERV 8	✓
4" Pleated - 30% Efficient - MERV 8	✓
2" Permanent Filter Frame	✓
12" Cartridge - 65% Efficient - MERV 11	✓
12" Cartridge - 85% Efficient - MERV 13	✓
12" Cartridge - 95% Efficient - MERV 14	✓
30" Bag - 85% Efficient - MERV 13	✓
30" Bag - 95% Efficient - MERV 14	✓



### Gas Heat Exchanger

Constructed from stainless steel with patented "dimple" design to maximize efficiency at all inlet air conditions. Burners have electronic ignition and safety shutdown.



### Walk-In Service Vestibule

The walk-in service vestibule provides shelter for the maintenance and service personnel while periodic maintenance is performed on the unit. A fluorescent light fixture is furnished in the compartment, controlled by a light switch at the door, and the vestibule can be heated and/or cooled for comfort.



### Spring Isolators

Spring isolators provide sound attenuation for the main blower section.



### Evaporator Coils

Each evaporator coil has a TXV. A double sloped drain pan is provided for positive drainage. Tubing is dressed and structurally supported.

# RL Series

	Air Handling Units (6,000 - 75,000 cfm)
<b>VFD Controlled Fan Options</b>	
Supply Fans	✓
Power Exhaust Fans	✓
Power Return Fans	✓
<b>Safety Options</b>	
Return Air Firestat	✓
Supply Air Firestat	✓
Return Air Smoke Detector	✓
Supply Air Smoke Detector	✓
<b>Control Options</b>	
Variable Air Volume (VAV)	✓
Constant Air Volume	✓
Single Zone VAV	✓
Makeup Air	✓
Remote Start/Stop Terminals	✓
Customer Provided Controller - Field Installed	✓
Customer Provided Controller - Factory Installed	✓
<b>Preheat Options</b>	
Steam Distributing Coil	✓
Hot Water Coil	✓
<b>Construction Options</b>	
Burglar Bars	✓
Access Door Windows	✓
Supply Fan Sound Attenuation	✓
Return Fan Sound Attenuation	✓
Single or Two Piece Unit	✓
<b>Code Options</b>	
Chicago Code	✓



### Blower Section

Single or multiple direct drive backward curved plenum fans with spring isolation on the entire assembly allows optimization of fan diameter, sound level, and efficiency.



### Economizer

A full line of economizer options are available. All are low leakage with extruded airfoil blades and rubber edge and aluminum end seals.



### AAONAIRE®

This energy recovery ventilation option can be provided in all model sizes allowing reduced equipment size and operating cost savings while pre-conditioning the outside air being introduced into the conditioned space.



### Optional Exhaust and Return Fans

The axial flow and plenum power exhaust and return fans are directly driven by the motor.



AAON **RZ SERIES OUTDOOR AIR HANDLING UNITS** SET THE STANDARD FOR LARGE COMMERCIAL OUTDOOR SELF-CONTAINED UNITS IN CUSTOMIZATION, PERFORMANCE, AND SERVICEABILITY. DOUBLE WALL RIGID POLYURETHANE FOAM INSULATED CABINET CONSTRUCTION AND AN ARRAY OF DRAW-THROUGH OR BLOW-THROUGH DIRECT DRIVE BACKWARD CURVED PLENUM FANS ALLOW RZ SERIES UNITS TO HAVE QUIET, ENERGY EFFICIENT AIRFLOW WITH HIGH STATIC PRESSURE CAPABILITIES.

### Applications

- Chilled water or non-compressorized DX air handling unit, from 8,900 - 75,500 cfm.
- Packaged rooftop unit with an air-cooled, water-cooled, or evaporative-cooled condenser, from 55-240 tons.
- Available as an air-source, water-source, or geothermal heat pump.
- Makeup air capability, up to 100% outside air, to meet ventilation requirements.
- High performance hot water, steam, electric and indirect/direct fired gas heating.

### Construction

- Two-inch double wall rigid polyurethane foam panel cabinet construction has a thermal resistance of R-13 or greater, which exceeds the R-value of a cabinet with four-inch thick fiberglass construction. Panels include a thermal break, with no metal contact from inside to outside, to prevent heat transfer through the panel and prevent condensation on the outside of the cabinet. The inner wall protects the insulation from moisture damage, prevents microbial growth, and is easy to clean. This type of construction also makes the cabinet more rigid and resistant to damage, provides increased sound dampening, and reduces air leakage and infiltration.
- Access doors with full length stainless steel piano hinges and quarter turn, zinc cast, lockable handles provide improved reliability over single point hinges and plastic or sheet metal handles, and make the unit easily serviceable.
- Aluminum tread plate flooring is included in equipment access areas for improved durability and safety.
- Corrosion resistant exterior polyurethane paint exceeds a 2,500 hour salt spray test.
- Double sloped stainless steel drain pans eliminate standing water which can support microbial growth and stainless steel construction prevents corrosion that could lead to water leaks and contaminants in the air stream.



▲ RZ Series Air Handling Unit

### Fans and Blowers

- Spring isolated direct drive backward curved plenum fans are more energy efficient, quieter, and require less maintenance than belt driven fans. These single thickness airfoil plenum blowers are quieter and more energy efficient than forward curved blowers.
- Selectable number of draw-through or blow-through direct drive backward curved plenum fans allows design flexibility for quieter applications and applications where unit uptime is critical.
- VFD controlled supply, exhaust, and return fans for precise airflow control, building pressure control, and reduced power consumption.



▲ Direct Drive Axial Flow Exhaust/Return Fans are more energy efficient and require less maintenance than belt driven fans.



### Controls

- Labeled electrical components and color-coded wiring match the unit specific color-coded wiring diagram which is laminated and permanently affixed inside the control compartment.
- Factory provided or customer provided controller can be selected to meet existing or new building control architecture.
- Unit controls are contained within a walk-in service compartment isolated from the air stream for ease of service and quiet operation. Service compartment can be independently heated.
- Run test report, color-coded wiring diagram, and Installation, Operation and Maintenance manual with startup form are included in control access compartment of every unit.



◀ Spring isolated direct drive backward curved plenum fans are more efficient, have higher static pressure capacities and require less maintenance than belt driven, forward curved fans.

### Features and Options

- Split system modulating humidity control is available to provide energy efficient dehumidification, even with low sensible heat loads, without the temperature swings common with on/off reheat systems.
- High efficiency, multiple stage, gas and electric heating are available to meet job requirements.
- Factory installed, sensible or enthalpy, gear driven economizer allows for free cooling.
- Multiple high efficiency filtration options, including pleated, cartridge, or bag type, with up to a MERV 14 efficiency rating.
- Factory installed total and sensible AAONAIRE® energy recovery wheels save cooling and heating dollars. Return fans are available for high return static applications.
- Polymer e-coated coils are available to extend the life of the coils and protect them in corrosive environments.
- Interior corrosion protection option protects interior components of the unit in corrosive environments.



#### AAONAIRE®

This energy recovery ventilation option can be provided in all model sizes allowing reduced equipment size and operating cost savings while pre-conditioning the outside air being introduced into the conditioned space.

RZ Model	Nomial cfm	Width	Height	Length
055	15,000	142	104	Length varies depending on options selected
065	17,000			
075	18,000			
090	22,000			
105	24,000			
120	29,500			
130	32,000			
140	33,000			

\*Dimension may vary depending on options selected.

All dimensions are in inches.

Design cfm may be 30-50% greater or less than nominal cfm.



# RZ Series

Air Handling Units (6,000 - 75,500 cfm)	
<b>Cooling Options</b>	
Air Handling Unit - No Cooling	✓
Air Handling Unit - DX Coil	✓
Air Handling Unit - Chilled Water Coil	✓
<b>Heating Options</b>	
Electric Heat	✓
Natural Gas	✓
Steam Distributing Coil	✓
Hot Water Coil	✓
<b>Refrigeration Options</b>	
Modulating Hot Gas Reheat	✓
<b>Unit Air Intake Options</b>	
Economizer	✓
Energy Recovery Wheel - Total or Sensible	✓
100% Outside Air Unit	✓
<b>Serviceability Options</b>	
Factory Wired Convenience Outlet	✓
Service Lights	✓
<b>Filter Options</b>	
2" Pleated - 30% Efficient - MERV 8	✓
4" Pleated - 30% Efficient - MERV 8	✓
2" Permanent Filter Frame	✓
12" Cartridge - 65% Efficient - MERV 11	✓
12" Cartridge - 85% Efficient - MERV 13	✓
12" Cartridge - 95% Efficient - MERV 14	✓
30" Bag - 85% Efficient - MERV 13	✓
30" Bag - 95% Efficient - MERV 14	✓



### Walk-In Service Vestibule

The walk-in service vestibule provides shelter for the maintenance and service personnel while periodic maintenance is performed on the unit. A fluorescent light fixture is furnished in the compartment, controlled by a light switch at the door, and the vestibule can be heated and/or cooled for comfort.



### Spring Isolators

Spring isolators provide sound attenuation for the main blower section.



### Evaporator Coils

Each evaporator coil has a TXV. A double sloped drain pan is provided for positive drainage. Tubing is dressed and structurally supported.



### Gas Heat Exchanger

Constructed from stainless steel with patented "dimple" design to maximize efficiency at all inlet air conditions. Burners have electronic ignition and safety shutdown.



# RZ Series

	Air Handling Units (6,000 - 75,500 cfm)
<b>VFD Controlled Fan Options</b>	
Supply Fans	✓
Power Exhaust Fans	✓
Power Return Fans	✓
<b>Safety Options</b>	
Return Air Firestat	✓
Supply Air Firestat	✓
Return Air Smoke Detector	✓
Supply Air Smoke Detector	✓
<b>Control Options</b>	
Variable Air Volume (VAV)	✓
Constant Air Volume	✓
Single Zone VAV	✓
Makeup Air	✓
Remote Start/Stop Terminals	✓
Customer Provided Controller - Field Installed	✓
Customer Provided Controller - Factory Installed	✓
<b>Preheat Options</b>	
Steam Distributing Coil	✓
Hot Water Coil	✓
<b>Construction Options</b>	
Burglar Bars	✓
Access Door Windows	✓
Supply Fan Sound Attenuation	✓
Return Fan Sound Attenuation	✓
Single or Two Piece Unit	✓
<b>Code Options</b>	
Chicago Code	✓



### Blower Section

Single or multiple direct drive backward curved plenum fans with spring isolation on the entire assembly allows optimization of fan diameter, sound level, and efficiency.



### Economizer

A full line of economizer options are available. All are low leakage with extruded airfoil blades and rubber edge and aluminum end seals.



### Lockable Handles

Walk-in doors are constructed with stainless steel piano hinges, perimeter gaskets, and zinc cast lockable handles that operate from a single point.



### Optional Exhaust and Return Fans

The axial flow and plenum power exhaust and return fans are directly driven by the motor.



AAON **RN SERIES OUTDOOR AIR HANDLING UNITS** ARE ENGINEERED FOR PERFORMANCE, FLEXIBILITY, AND SERVICEABILITY. DOUBLE WALL RIGID POLYURETHANE FOAM INSULATED CABINET CONSTRUCTION AND DIRECT DRIVE BACKWARD CURVED PLENUM FANS ALLOW RN SERIES UNITS TO HAVE QUIET, ENERGY EFFICIENT AIRFLOW WITH HIGH STATIC PRESSURE CAPABILITIES. RN SERIES AIR HANDLING UNITS CAN BE MATCHED WITH AAON CONDENSING UNITS OR AN AAON CHILLER FOR A COMPLETE SYSTEM.

### Applications

- Chilled water or non-compressorized DX air handling units, 1,000–49,000 cfm.
- Air-cooled condenser or air-source heat pump packaged DX rooftop units, 6–140 tons.
- Water-cooled condenser, water-source heat pump, or geothermal heat pump configurations.
- Makeup air capability, up to 100% outside air, to meet ventilation requirements.
- High performance hot water, steam, electric, and gas heating.

### Construction

- Two-inch double wall rigid polyurethane foam panel cabinet construction has a thermal resistance of R-13 or greater, which exceeds the R-value of a cabinet with four-inch thick fiberglass construction. Panels include a thermal break, with no metal contact from inside to outside, to prevent heat transfer through the panel and prevent condensation on the outside of the cabinet. The inner wall protects the insulation from moisture damage, prevents microbial growth, and is easy to clean. This type of construction also makes the cabinet more rigid and resistant to damage, provides increased sound dampening, and reduces air leakage and infiltration.
- Access doors with full length stainless steel piano hinges and quarter turn lockable handles provide improved reliability over single point hinges and make the unit easily serviceable.
- Corrosion resistant exterior polyurethane paint exceeds a 2,500 hour salt spray test.
- Double sloped stainless steel drain pans eliminate standing water which can support microbial growth and stainless steel construction prevents corrosion that could lead to water leaks and contaminants in the air stream.
- AMCA Certified low leakage gear driven economizer dampers are standard on RN Series units. AAON low leakage dampers meet the California Title 24 damper air leakage requirement. Optional Economizer Fault Detection and Diagnostics is also available with the low leakage dampers to meet the California Title 24 requirements.



▲ RN Series air handling unit with piping service access.

### Fans and Blowers

- Direct drive backward curved plenum fans are more energy efficient, quieter, and require less maintenance than belt driven fans. These single thickness airfoil plenum blowers are quieter and more energy efficient than forward curved blowers.
- VFD controlled supply, exhaust, and return fans for precise airflow control, building pressure control, and reduced power consumption.

### Controls

- Labeled electrical components and color-coded wiring match the unit specific color-coded wiring diagram which is laminated and permanently affixed inside the control compartment.
- Factory provided or customer provided controller can be selected to meet existing or new building control architecture.
- Unit controls are contained within single compartment isolated from the air stream for ease of service and quiet operation.
- Run test report, color-coded wiring diagram, and Installation, Operation, and Maintenance manual with startup form are included in control access compartment of every unit.

### Horizontal Configuration

Horizontal configuration is available for RN Series units (11, 13, 16–30 tons). This configuration provides a solution for applications that require horizontal ductwork; it does not require special horizontal supply return curbs. All of the premier features and options currently available on RN Series units are available with this configuration. **High efficiency final filtration configuration is available on the RN Series units for health care and other applications that require it.**

## Features and Options

- Split system modulating humidity control is available to provide energy efficient dehumidification, even with low sensible heat loads, without the temperature swings common with on/off reheat systems.
- Modulating gas heat and SCR electric heat provide energy efficient, consistent supply air temperature heating and improved occupancy comfort.
- Factory installed, sensible or enthalpy, gear driven economizer allows for free cooling.

- Multiple high efficiency filtration options, with up to a MERV 14 efficiency rating.
- Factory installed total and sensible AAONAIRE® energy recovery wheels save cooling and heating dollars.
- Polymer e-coated coils are available to extend the life of the coils and protect them in corrosive environments.
- Interior corrosion protection option protects interior components of the unit in corrosive environments.
- Seismically certified construction options are available to meet California OSHPD or ASCE 7-05 / ICC-ES AC 156 requirements.

RN Model	Cabinet	Configuration	Nominal cfm	Width*	Height*	Length*
RN-006	A	Vertical	2,000	79	44	82
RN-007			2,500			
RN-008			2,650			
RN-010			3,000			
RN-009	B		3,400	96	50	88
RN-011			3,600			
RN-013			3,800			
RN-015			4,200			
RN-016	C		6,400	101	60	110
RN-018			6,800			
RN-020			7,000			
RN-025			9,000			
RN-030	D	10,500	100	102	155	
RN-026		10,000				
RN-031		12,400				
RN-040		16,000				
RN-050	E	20,000	142	105	241	
RN-060		23,000				
RN-070		25,000				
RN-055		15,000				
RN-065		17,000			303	
RN-075		18,000				
RN-090		22,000				
RN-105		24,000				
RN-120	29,500	C	Horizontal	101	60	138
RN-130	32,000					
RN-140	33,000					
RNA-11	3,600					
RNA-13	3,800					
RNA-16	6,400					
RNA-18	6,800					
RNA-20	7,000					
RNA-25	9,000					
RNA-30	10,500					



▲ Dimpled Gas Heat Exchanger provides corrosion resistant, energy efficient heating without the use of internal turbulators.



▲ Factory Installed AAONAIRE® energy recovery wheel saves heating and cooling energy.



\*Dimensions vary depending on options selected. • All dimensions are in inches. • Design cfm may be 30-50% greater or less than nominal cfm.



# RN Series

	<b>A Cabinet</b> (1,000-5,500 cfm)	<b>B Cabinet</b> (1,500-7,500 cfm)	<b>C Cabinet</b> (2,500-13,500 cfm)	<b>D Cabinet</b> (3,500-31,000 cfm)	<b>E Cabinet</b> (6,000-49,000 cfm)
<b>Configuration Options</b>					
Vertical	✓	✓	✓	✓	✓
Horizontal			✓		
<b>Cooling Options</b>					
Air Handling Unit - No Cooling	✓	✓	✓	✓	✓
Air Handling Unit - DX Coil	✓	✓	✓	✓	✓
Air Handling Unit - Chilled Water Coil	✓	✓	✓	✓	✓
<b>Heating Options</b>					
Electric Heat	✓	✓	✓	✓	✓
Natural Gas	✓	✓	✓	✓	✓
Natural Gas Modulating	✓	✓	✓	✓	✓
LP Gas	✓	✓	✓	✓	✓
Steam Distributing Coil	✓	✓	✓	✓	✓
Hot Water Coil	✓	✓	✓	✓	✓
Air-Source Heat Pump	✓	✓	✓	✓	✓
<b>Unit Air Intake Options</b>					
Economizer	✓	✓	✓	✓	✓
Energy Recovery Wheel - Total or Sensible	✓	✓	✓	✓	✓
100% Outside Air Unit	✓	✓	✓	✓	✓
100% Return Air Unit	✓	✓	✓	✓	✓
<b>Serviceability Options</b>					
Factory Wired Convenience Outlet	✓	✓	✓	✓	✓
Service Lights	✓	✓	✓	✓	✓
<b>Filter Options</b>					
Metal Mesh Pre Filter	✓	✓	✓	✓	✓
Lint Screen Pre Filter	✓	✓	✓	✓	✓
2" Pleated - 30% Efficient - MERV 8	✓	✓	✓	✓	✓
4" Pleated - 30% Efficient - MERV 8	✓	✓	✓	✓	✓
2" Permanent Filter Frame	✓	✓	✓	✓	✓
4" Pleated - 65% Efficient - MERV 11	✓	✓	✓	✓	✓
4" Pleated - 85% Efficient - MERV 13	✓	✓	✓	✓	✓
4" Pleated - 95% Efficient - MERV 14	✓	✓	✓	✓	✓



# RN Series

	<b>A Cabinet</b> (1,000-5,500 cfm)	<b>B Cabinet</b> (1,500-8,500 cfm)	<b>C Cabinet</b> (2,500-13,500 cfm)	<b>D Cabinet</b> (3,500-31,000 cfm)	<b>E Cabinet</b> (6,000-49,000 cfm)
<b>Safety Options</b>					
Return Air Firestat	✓	✓	✓	✓	✓
Supply Air Firestat	✓	✓	✓	✓	✓
Return Air Smoke Detector	✓	✓	✓	✓	✓
Supply Air Smoke Detector	✓	✓	✓	✓	✓
<b>Control Options</b>					
Variable Air Volume (VAV)	✓	✓	✓	✓	✓
Constant Air Volume	✓	✓	✓	✓	✓
Single Zone VAV	✓	✓	✓	✓	✓
Makeup Air	✓	✓	✓	✓	✓
Remote Start/Stop Terminals	✓	✓	✓	✓	✓
Customer Provided Controller - Field Installed	✓	✓	✓	✓	
Customer Provided Controller - Factory Installed	✓	✓	✓	✓	
<b>Preheat Options</b>					
Steam Distributing Coil	✓	✓	✓	✓	
Hot Water Coil	✓	✓	✓	✓	
Electric Preheat	✓	✓	✓		
<b>Construction Options</b>					
Base Insulation	✓	✓	✓	Standard	Standard
Burglar Bars	✓	✓	✓	✓	✓
<b>Code Options</b>					
Chicago Code	✓	✓	✓	✓	✓
California OSHPD - Seismic Certified	✓	✓	✓	✓	
Shake Table Certified	✓	✓	✓	✓	
Seismic Construction	✓	✓	✓	✓	



AAON **RQ SERIES OUTDOOR AIR HANDLING UNITS** ARE ENGINEERED FOR PERFORMANCE, FLEXIBILITY, AND SERVICEABILITY. DOUBLE WALL RIGID POLYURETHANE FOAM INSULATED CABINET CONSTRUCTION AND DIRECT DRIVE BACKWARD CURVED PLENUM FANS ALLOW RQ SERIES UNITS TO HAVE QUIET, ENERGY EFFICIENT AIRFLOW WITH HIGH STATIC PRESSURE CAPABILITIES. RQ SERIES AIR HANDLING UNITS CAN BE MATCHED WITH AAON CONDENSING UNITS OR AN AAON CHILLER FOR A COMPLETE SYSTEM.

### Applications

- Chilled water or non-compressorized DX air handling units, 400-3,300 cfm.
- Air-cooled condenser or air-source heat pump packaged DX rooftop units, 2-6 tons.
- Water-cooled condenser, water-source heat pump, or geothermal heat pump configurations.
- Makeup air capability, up to 100% outside air, to meet ventilation requirements.
- High performance hot water, steam, electric, and gas heating.



▲ RQ Series Air Handling Unit

### Construction

- Two-inch double wall rigid polyurethane foam panel cabinet construction has a thermal resistance of R-13 or greater, which exceeds the R-value of a cabinet with four-inch thick fiberglass construction. Panels include a thermal break, with no metal contact from inside to outside, to prevent heat transfer through the panel and prevent condensation on the outside of the cabinet. The inner wall protects the insulation from moisture damage, prevents microbial growth, and is easy to clean. This type of construction also makes the cabinet more rigid and resistant to damage, provides increased sound dampening, and reduces air leakage and infiltration.
- Access doors with full length stainless steel piano hinges and quarter turn lockable handles provide improved reliability over single point hinges and make the unit easily serviceable.

- Corrosion resistant exterior polyurethane paint exceeds a 2,500 hour salt spray test.
- Double sloped stainless steel drain pans eliminate standing water which can support microbial growth and stainless steel construction prevents corrosion that could lead to water leaks and contaminants in the air stream.
- AMCA Certified low leakage gear driven economizer dampers are standard on RQ Series units. AAON low leakage dampers meet the California Title 24 damper air leakage requirement. Optional Economizer Fault Detection and Diagnostics is also available with the low leakage dampers to meet the California Title 24 requirements.

### Horizontal Configuration

Horizontal configuration is available for RQ Series units (2-6 tons). This configuration provides a solution for applications that require horizontal ductwork; it does not require special horizontal supply/return curbs. All of the premier features and options currently available for the RQ units are available with this configuration.

RQ Model	Configuration	Nominal cfm	Width	Height*	Length*
RQ-002	Vertical or Horizontal	850	44	43	82
RQ-003		1,050			
RQ-004		1,400			
RQ-005		1,750			
RQ-006		1,800			

\*Dimensions vary depending on options selected.  
All dimensions are in inches.  
Design cfm may be 30-50% greater or less than nominal cfm.



## Fans and Blowers

- Direct drive backward curved plenum fans are more energy efficient, quieter, and require less maintenance than belt driven fans. These single thickness airfoil plenum blowers are quieter and more energy efficient than forward curved blowers.
- VFD controlled or ECM driven supply, exhaust, and return fans for precise airflow control, building pressure control, and reduced power consumption.

## Controls

- Labeled electrical components and color-coded wiring match the unit specific color-coded wiring diagram which is laminated and permanently affixed inside the control compartment.
- Factory provided or customer provided controller can be selected to meet existing or new building control architecture.
- Unit controls are contained within single compartment isolated from the air stream for ease of service and quiet operation.
- Run test report, color-coded wiring diagram, and Installation, Operation, and Maintenance manual with startup form are included in control access compartment of every unit.

## Features and Options

- Split system modulating humidity control is available to provide energy efficient dehumidification, even with low sensible heat loads, without the temperature swings common with on/off reheat systems.
- Modulating gas heat and SCR electric heat provide energy efficient, consistent supply air temperature heating and improved occupancy comfort.
- Factory installed, sensible or enthalpy, gear driven economizer allows for free cooling.
- Multiple high efficiency filtration options, with up to a MERV 14 efficiency rating.



- ▶ Dimpled Gas Heat Exchanger provides corrosion resistant, energy efficient heating without the use of internal turbulators.

- Factory installed total and sensible AAONAIRES® energy recovery wheels save cooling and heating dollars.
- Polymer e-coated coils are available to extend the life of the coils and protect them in corrosive environments.
- Interior corrosion protection option protects interior components of the unit in corrosive environments.
- Seismically certified construction options are available to meet California OSHPD or ASCE 7-05 / ICC-ES AC 156 requirements.



- ▲ Gas heater access is provided through hinged access door.



# RQ Series

	2 ton (800 cfm)	3 ton (1,200 cfm)	4 ton (1,600 cfm)	5 ton (2,000 cfm)	6 ton (2,400 cfm)
<b>Configuration Options</b>					
Vertical	✓	✓	✓	✓	✓
Horizontal	✓	✓	✓	✓	✓
<b>Cooling Options</b>					
Air Handling Unit - DX Coil	✓	✓	✓	✓	✓
Air Handling Unit - Chilled Water Coil	✓	✓	✓	✓	✓
<b>Heating Options</b>					
Electric Heat	✓	✓	✓	✓	✓
Natural Gas	✓	✓	✓	✓	✓
Natural Gas Modulating	✓	✓	✓	✓	✓
LP Gas	✓	✓	✓	✓	✓
Steam Distributing Coil	✓	✓	✓	✓	✓
Hot Water Coil	✓	✓	✓	✓	✓
<b>Unit Air Intake Options</b>					
Economizer	✓	✓	✓	✓	✓
Energy Recovery Wheel	✓	✓	✓	✓	✓
Cross-Flow Fixed Plate Energy Recovery - Total or Sensible	✓	✓	✓	✓	✓
100% Outside Air Unit	✓	✓	✓	✓	✓
100% Return Air Unit	✓	✓	✓	✓	✓
<b>Serviceability Options</b>					
Factory Wired Convenience Outlet	✓	✓	✓	✓	✓
Service Lights	✓	✓	✓	✓	✓
<b>Filter Options</b>					
Metal Mesh Pre Filter	✓	✓	✓	✓	✓
Lint Screen Pre Filter	✓	✓	✓	✓	✓
2" Throwaway	✓	✓	✓	✓	✓
2" Pleated - 30% Efficient - MERV 8	✓	✓	✓	✓	✓
4" Pleated - 30% Efficient - MERV 8	✓	✓	✓	✓	✓
2" Permanent Filter Frame	✓	✓	✓	✓	✓
4" Pleated - 65% Efficient - MERV 11	✓	✓	✓	✓	✓
4" Pleated - 85% Efficient - MERV 13	✓	✓	✓	✓	✓



# RQ Series

	2 ton (800 cfm)	3 ton (1,200 cfm)	4 ton (1,600 cfm)	5 ton (2,000 cfm)	6 ton (2,400 cfm)
<b>Safety Options</b>					
Return Air Firestat	✓	✓	✓	✓	✓
Supply Air Firestat	✓	✓	✓	✓	✓
Return Air Smoke Detector	✓	✓	✓	✓	✓
Supply Air Smoke Detector	✓	✓	✓	✓	✓
<b>Control Options</b>					
Variable Air Volume (VAV)	✓	✓	✓	✓	✓
Constant Air Volume	✓	✓	✓	✓	✓
Single Zone VAV	✓	✓	✓	✓	✓
Makeup Air	✓	✓	✓	✓	✓
Remote Start/Stop Terminals	✓	✓	✓	✓	✓
Customer Provided Controller - Field Installed	✓	✓	✓	✓	✓
Customer Provided Controller - Factory Installed	✓	✓	✓	✓	✓
<b>Preheat Options</b>					
Steam Distributing Coil	✓	✓	✓	✓	✓
Hot Water Coil	✓	✓	✓	✓	✓
Electric Preheat	✓	✓	✓	✓	✓
<b>Construction Options</b>					
Base Insulation	✓	✓	✓	✓	✓
Burglar Bars	✓	✓	✓	✓	✓
<b>Code Options</b>					
Chicago Code	✓	✓	✓	✓	✓
California OSHPD - Seismic Certified	✓	✓	✓	✓	✓
Shake Table Certified	✓	✓	✓	✓	✓
Seismic Construction	✓	✓	✓	✓	✓

# AAON QUICK SELECTION

**Airflow (cfm)**

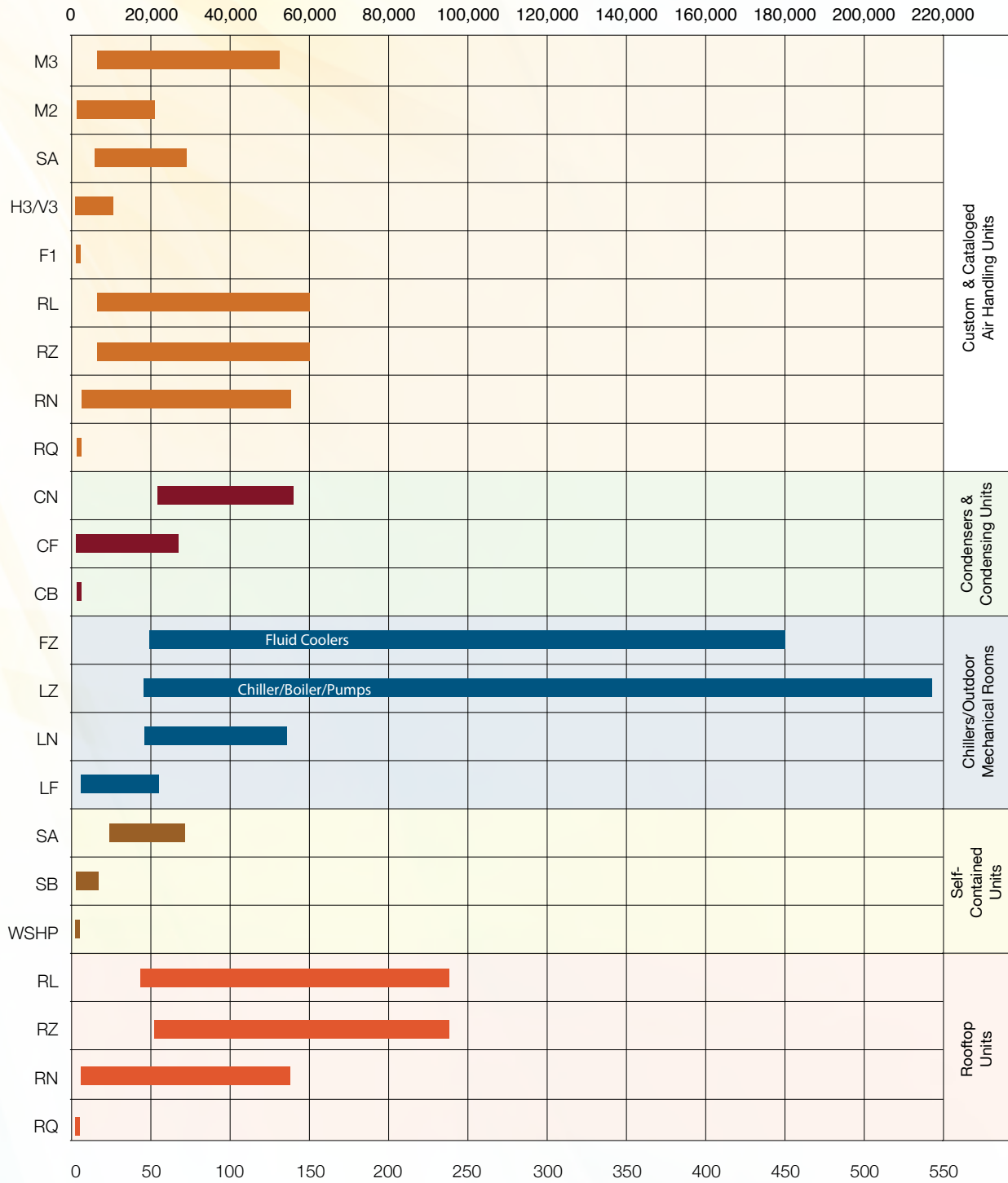

**Nominal Cooling (tons)**



**Don't see the specific product you need?** AAON can meet your requirements with Custom Equipment designed specifically for your exact application and job specifications. Visit [www.aaon.com/repsearch](http://www.aaon.com/repsearch) or call 918.583.2266 to locate a representative near you.

# CONDENSERS & CONDENSING UNITS

(Air-Cooled & Heat Pumps)



AAON **CN SERIES CONDENSING UNITS** OFFER A COST EFFECTIVE, FEATURE LADEN APPROACH TO ENERGY EFFICIENT COOLING. THE SPLIT SYSTEM CONDENSING UNITS REFLECT THE PROVEN RELIABILITY AND ENGINEERING EXCELLENCE FROM THE PREMIER MANUFACTURER OF HEATING AND COOLING PRODUCTS. AAON CN SERIES CONDENSING UNITS BOAST THE SAME WORLD CLASS BENEFITS THAT CUSTOMERS HAVE COME TO EXPECT FROM AAON PACKAGED EQUIPMENT: SERVICEABILITY, QUIET OPERATION, RELIABILITY, PREMIUM EFFICIENCY, RUGGED CONSTRUCTION, AND A NUMBER OF OPTIONS THAT PROVIDE THE FLEXIBILITY TO SUIT ANY APPLICATION.

### Applications

- Air-cooled split system condensing units with capacities from 55 to 140 tons
- VFD controlled variable speed R-410A scroll compressors offer load matching cooling and increased part load efficiency
- Makeup air capability, up to 100% outside air, when paired with a matching AAON air handling unit

### Construction

- Two inch double wall polyurethane foam panel construction makes the cabinet more rigid and resistant to damage, and attenuates radiated compressor sound.
- Standard perforated metal condenser coil guards help protect condenser coils from damage.
- Compressors are factory installed on structural decks and rubber isolation mounts for quiet and efficient operation.
- Access doors with full length stainless steel piano hinges and zinc cast, lockable handles provide ample access and serviceability to the isolated compressor and controls compartment.
- Designed specifically for outdoor operation, CN Series condensing units include UV and corrosion resistant exterior paint that exceeds a 2,500 hour salt-spray test.

- ▶ Microchannel condenser coils are more efficient, lighter, and use less refrigerant than traditional fin and tube condenser coils.



▲ CN Series Condensing Unit

### Controls

- Run test report, color-coded wiring diagram, and Installation, Operation, and Maintenance manual with startup form are included in the controls compartment.
- Labeled electrical components and color-coded wiring match the unit specific color-coded wiring diagram which is laminated and permanently affixed inside the control compartment
- Factory provided or customer provided controller can be selected to meet existing or new building control architecture
- Compressor and unit controls are contained within a single compartment isolated from the air stream for ease of service and quiet operation



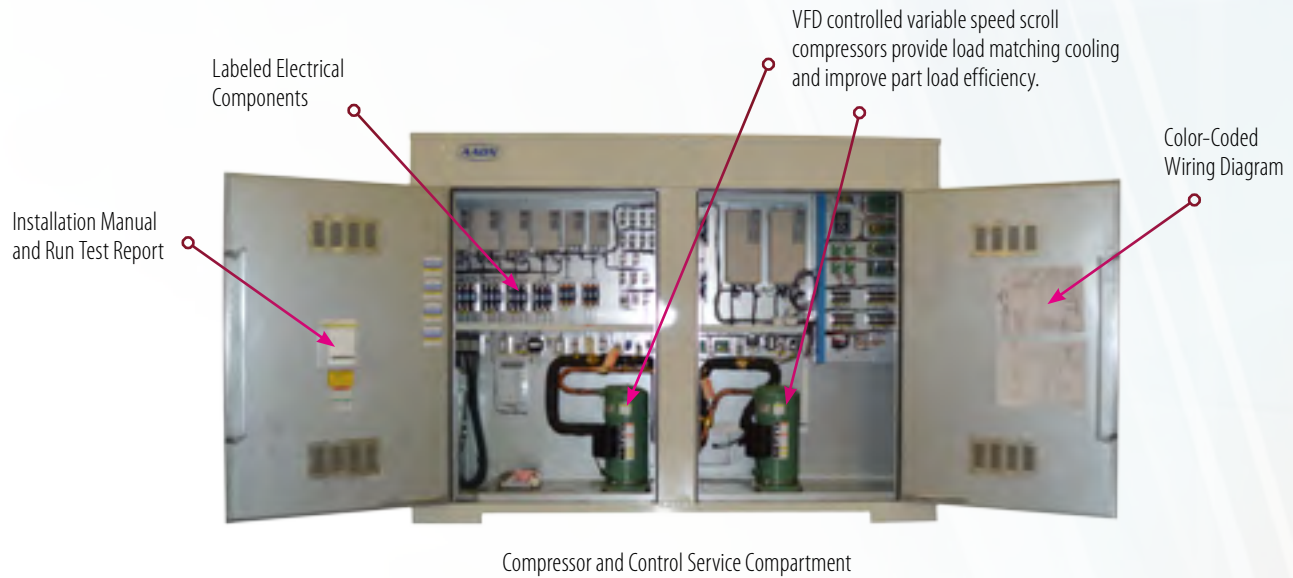

Compressor and Control Service Compartment

### Features and Options

- Split system modulating humidity control is available to provide energy efficient dehumidification, even with low sensible heat loads, without the temperature swings common with on/off reheat systems.
- Polymer e-coated coils are available to extend the life of the coils and protect them in corrosive environments.
- VFD controlled condenser fans for head pressure control, reduced power consumption, and lower sound levels at off-design ambient conditions.
- High efficiency air-cooled microchannel condenser is designed to maximize performance of the condensing unit.
- VFD controlled variable speed condenser fans increase part load efficiency and offer complete capacity modulation when coupled with VFD controlled variable speed compressors.
- Flooded condenser low ambient controls allow mechanical cooling operation during periods of low ambient conditions down to 0°F.
- Optional 5 year non-prorated compressor warranty.

CN Model	Cabinet	Width	Height	Length
055	A	142	104	90
065				
075				
090	B	142	104	152
105				
120	C	142	104	152
130				
140				

*All dimensions are in inches.*



VFD controlled variable speed scroll compressors provide load matching cooling and improve part load efficiency.





### Variable Capacity Scroll Compressors

CN Series condensing units are available with lead VFD controlled variable speed scroll compressors that can modulate compressor capacity. This allows the system, when paired with a matching AAON air handling unit, to maintain consistent supply air temperatures at all operating conditions. During part load operation, reducing compressor capacity increases part load efficiency and ultimately saves valuable system operating costs. CN Series units are also available with VFD controlled compressors on all circuits to maximize energy savings.

### Variable Speed Condenser Fans

CN Series condensing units are available with VFD controlled condenser fans that increase part load efficiency and save operating costs. The factory controlled VFDs vary the fan speed for head pressure control.

### Microchannel Condenser

CN Series condensing units are designed with microchannel condenser coils that are more efficient, lighter, and use less refrigerant than traditional fin and tube condenser coils. The microchannel tube design increases unit efficiency by enhancing heat transfer, and the all aluminum construction of the coil is up to 30 percent lighter than fin and tube coils.

### Dehumidification

CN Series condensing units are available with modulating hot gas reheat humidity control. Factory installed reheat valves use only the minimum amount of reheat to deliver a consistent supply air temperature during dehumidification. Modulating hot gas reheat provides energy efficient dehumidification when paired with AAON air handling units containing high capacity cooling coils.

### Split System Matching

CN Series condensing units can be paired with AAON RN Series, M3 Series, and M2 Series air handling units. The AAON ECat selection software includes refrigeration options, such as Modulating Hot Gas Reheat or Flooded Condenser 0°F Low Ambient, when matching a split system. Pairing a CN Series condensing unit with an AAON air handling unit simplifies installation with split system piping and control wiring.

# CN Series

	<b>A Cabinet</b> (55-75 tons)	<b>B Cabinet</b> (90-105 tons)	<b>C Cabinet</b> (120-140 tons)
<b>Cooling Options</b>			
Number of Compressors/Circuits	4/2 or 2/2	4/2 or 2/2	4/4
Variable Speed Compressors	✓	✓	✓
<b>Refrigeration Options</b>			
Modulating Hot Gas Reheat	✓	✓	✓
0°F Flooded Condenser Low Ambient Controls	✓	✓	✓
Adjustable Fan Cycling	✓	✓	✓
VFD Controlled Condenser Fans with Head Pressure Control	✓	✓	✓
<b>Serviceability Options</b>			
Disconnect Switch	✓	✓	✓
Sight Glass	✓	✓	✓
Compressor Isolation Valves	✓	✓	✓
Service Access Lights	✓	✓	✓
Convenience Outlet	✓	✓	✓
<b>Safety Options</b>			
Phase and Brownout Protection	✓	✓	✓
Adjustable Compressor Lock-out	✓	✓	✓
<b>Control Options</b>			
Variable Air Volume (VAV)	✓	✓	✓
Constant Air Volume	✓	✓	✓
Single Zone VAV	✓	✓	✓
Makeup Air Unit	✓	✓	✓
Remote Start/Stop Terminals	✓	✓	✓
Customer Provided - Field Installed	✓	✓	✓
Customer Provided - Factory Installed	✓	✓	✓
<b>Code Options</b>			
Chicago Code	✓	✓	✓



AAON **CF SERIES SPLIT SYSTEM CONDENSING UNITS** ARE THE IDEAL SOLUTION FOR PREMIUM EFFICIENCY SPLIT SYSTEM APPLICATIONS. FACTORY INSTALLED OPTIONS MINIMIZE FIELD INSTALLATION TIME AND COST. CF SERIES CONDENSING UNITS BOAST THE SAME BENEFITS THAT CUSTOMERS HAVE COME TO EXPECT FROM OTHER AAON PRODUCTS: SERVICEABILITY, QUIET OPERATION, RELIABILITY, PREMIUM EFFICIENCY, WORLD CLASS CONSTRUCTION, AND A NUMBER OF PREMIER OPTIONS THAT PROVIDE THE FLEXIBILITY TO SUIT ANY APPLICATION.

### Applications

- 2-70 ton air-cooled condensing units and remote air-cooled condensers.
- Air-source heat pump configurations for energy efficient heating and cooling.
- Variable capacity (10-100%) scroll compressors for load matching cooling and heat pump heating.
- Makeup air capability, up to 100% outside air, when paired with matching AAON air handling unit.

### Construction

- Compressors and controls are housed in a galvanized steel service compartment. Access doors with full length stainless steel piano hinges and lockable handles provide superior access and serviceability for the isolated compressor and controls compartment.
- Compressors are factory installed with rubber isolation mounts on structural decks in an isolated service compartment for quiet operation. A cabinet units (2-7 tons) are designed without the decks.
- Designed specifically for outdoor operation, CF Series condensing units include corrosion resistant exterior paint that exceeds a 2,500 hour salt spray test.



▲ CF Series Condensing Unit



## Features and Options

- Run test report, color-coded wiring diagram, and Installation, Operation, and Maintenance manual with startup form are included in the controls compartment.
- Labeled components and split system piping stub-outs for quick and easy installation.
- Staged, two-step, or 10-100% variable capacity R-410A scroll compressors are available for load matching cooling and heat pump heating.
- Polymer e-coated condenser coils are available to extend the life of the coils and protect them in corrosive environments.
- Modulating hot gas reheat for dehumidification with precise temperature and humidity control.
- Flooded condenser low ambient control allows cooling at temperatures down to 0°F.
- ECM driven or VFD controlled condenser fans for head pressure control and complete capacity modulation.
- 5 year non-prorated compressor warranty.



*Split system copper stub outs with shut-off valves are easily accessible outside of the cabinet.*

## Variable Capacity Scroll Compressors

CF series units are available with variable capacity scroll compressors that can modulate from 10-100% capacity. This allows the system, with a matching AAON air handling unit, to maintain consistent supply air temperatures at all operating conditions. During part load operation, reducing compressor capacity increases part load efficiency and saves valuable system operating costs.

## Dehumidification

CF Series units are available with modulating hot gas reheat control to provide energy efficient dehumidification, even with low sensible heat loads, without the temperature swings common with on/off reheat systems. Factory installed modulating valves allow only the necessary amount of reheat to create a consistent supply air temperature while maintaining space relative humidity.

## Air-Source Heat Pump

Air-source heat pumps provide energy efficient cooling and heating through the unit's refrigeration circuit. Air-source heat pumps transfer heat to the outside in the summer and to the space in the winter to provide both space heating and cooling. When paired with AAON air handling units, CF Series air-source heat pumps can create a complete dual fuel split system with hot water, steam, electric, or gas heating.

## Variable Speed Condenser Fans

CF Series condensing units are available with ECM driven or VFD controlled condenser fans that increase part load efficiency, provide complete capacity modulation, save operating costs, and reduce radiated sound. The condenser fans vary the airflow for head pressure control.

## Split System Matching

CF Series condensing units can be paired with AAON H3 Series, V3 Series, M2 Series, RQ Series, and RN Series air handling units. The AAON ECat selection software includes refrigeration options, such as Modulating Hot Gas Reheat or Flooded Condenser 0°F Low Ambient Controls, when matching an AAON split system. Pairing a CF Series condensing unit with an AAON air handling unit simplifies installation with factory supplied split system refrigerant line piping and wiring diagrams.



# CF Series

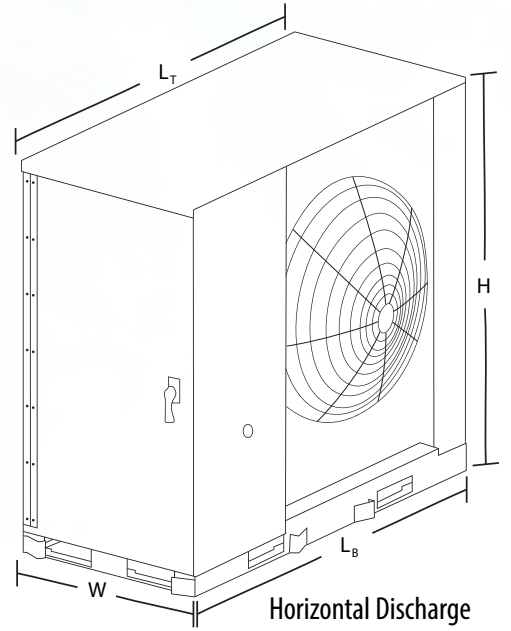
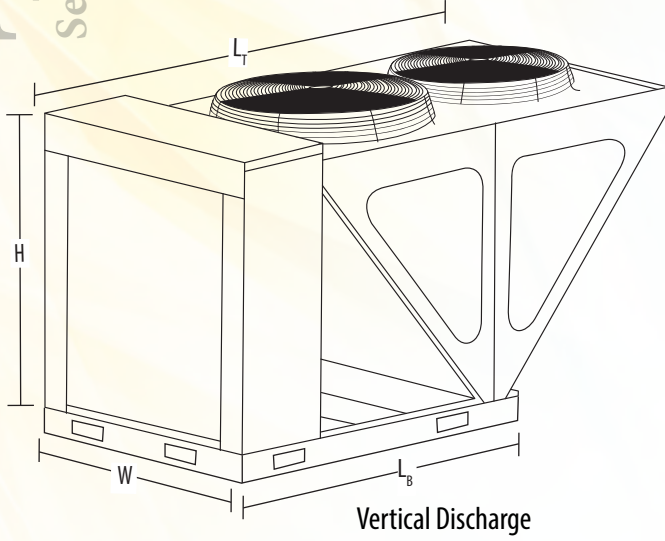

CF Model	Cabinet	Discharge Direction	Width	Height	Length Base	Length Top
002	A	Horiz.	30	57	63	63
003						
004						
005						
006						
007						
009	B	Vert.	46	53	61	95
011						
013						
015						
016						
018	C	Vert.	61	62	58	91
020						
025						
030						
026						
031						
040	D	Vert.	82	69	105	121
050						
060						
070						

All dimensions are in inches.

# CF Series

	A Cabinet (2-7 tons)	B Cabinet (9-16 tons)	C Cabinet (18-25 & 30 tons)	D Cabinet (26 & 31-70 tons)
<b>Cooling Options</b>				
Number of Compressors/Circuits	1/1	2/2	2/2	4/2 or 4/4
10-100% Variable Capacity Compressors	✓	✓	✓	✓
Discharge Air	Horizontal	Vertical	Vertical	Vertical
<b>Refrigeration Options</b>				
Air-Source Heat Pump	✓	✓	✓	✓
Modulating Hot Gas Reheat	✓	✓	✓	✓
0°F Flooded Condenser Low Ambient Controls	✓	✓	✓	✓
ECM Driven Condenser Fans with Head Pressure Control	✓	✓	✓	✓
VFD Controlled Condenser Fans with Heat Pressure Control		✓	✓	✓
<b>Serviceability Options</b>				
Single Point Non-Fused Disconnect	✓	✓	✓	✓
Sight Glass	✓	✓	✓	✓
Compressor Isolation Valves	✓	✓	✓	✓
115VAC Convenience Outlet	✓	✓	✓	✓
Service Access Lights	✓	✓	✓	✓
<b>Safety Options</b>				
Phase and Brownout Protection	✓	✓	✓	✓
Adjustable Compressor Lockout	✓	✓	✓	✓
Suction Pressure Transducer	✓	✓	✓	✓
<b>Cabinet Options</b>				
Compressor Sound Blanket	✓	✓	✓	✓
Condenser Coil Guards	✓	✓	✓	✓
<b>Control Options</b>				
Variable Air Volume (VAV)	✓	✓	✓	✓
Constant Air Volume	✓	✓	✓	✓
Single Zone VAV	✓	✓	✓	✓
Makeup Air Unit	✓	✓	✓	✓
Remote Start/Stop Terminals	✓	✓	✓	✓
Customer Provided - Field Installed	✓	✓	✓	✓
Customer Provided - Factory Installed	✓	✓	✓	✓



AAON **CB SERIES CONDENSERS & CONDENSING UNITS** ARE ENGINEERED TO BE ENERGY EFFICIENT, LONG LASTING, AND EASY TO INSTALL. STANDARD FEATURES INCLUDE VARIABLE SPEED ECM DRIVEN CONDENSER FANS, TWO STEP COMPRESSORS, AND A CONTINUOUS FIN CONDENSER COIL WITH LOUVERED COIL GUARD. CB SERIES CONDENSING UNITS CAN BE USED IN RESIDENTIAL AND COMMERCIAL APPLICATION, MATCHING WITH AAON AIR HANDLING UNITS.

### Applications

- Air-cooled condensing unit or a remote air-cooled condenser, from 2 - 5 tons or 24 - 60 MBH.
- Available as an air-source heat pump.
- Two step scroll compressor, 67% and 100% capacity, includes rubber isolation mounts to minimize vibration.
- Variable capacity scroll compressor (10 - 100%) for load matching cooling and heat pump heating and improved part load efficiency.

### Construction

- Wrap-around, single row condenser coil has no additional rows to trap dirt and debris between and is easier to clean than units with multi-row coils.
- Louvered condenser coil guards protect the coil from damage and debris.
- Corrosion resistant polyurethane paint exceeds a 2,500 hour salt spray test.
- Refrigerant circuit contains automatic low pressure and manual reset high pressure safety cut-outs, suction and liquid line Schrader valves, a full system charge of R-410A, and a factory provided liquid line filter drier.



▶ CB Series condensing unit and matching F1 Series air handling unit.

### Fans and Blowers

- ECM driven condenser fan provides precise airflow control and reduced power consumption while matching each capacity step of the compressor.



◀ CB Series condensing unit control compartment

CB Model	Compressors/Circuits	Discharge Direction	Width	Height	Length
024	1/1	Vertical	37	39	31
036					43
048					
060					

All dimensions are in inches.



# CB Series

## Controls

- Labeled electrical components and color-coded wiring match the unit specific color-coded wiring diagram which is inside the control compartment.
- Unit controls are contained within single compartment isolated from the air stream for ease of service and quiet operation.
- Factory run test report, wiring diagram, and Installation, Operation, and Maintenance manual with startup form are provided in the control compartment of every unit.
- Optional 24 VAC control circuit transformer to prevent exceeding the capacity of the air handler's control circuit transformer.

## Features and Options

- Split system modulating humidity control is available to provide energy efficient dehumidification, even with low sensible heat loads, without the temperature swings common with on/off reheat systems.
- High density foam compressor sound suppression blanket to reduce radiated noise.
- Polymer e-coated coils are available to extend the life of the coils and protect them in corrosive environments.
- Adjustable fan cycling or modulating head pressure control allow operation down to 35°F for applications that require mechanical cooling at lower ambient temperatures

	2-5 ton
<b>Cooling Options</b>	
Number of Compressors/Circuits	1/1
Two-Step Scroll Compressors	✓
10-100% Variable Capacity Compressors	3-5
Discharge Air	Vertical
<b>Refrigeration Options</b>	
Air-Source Heat Pump	✓
Modulating Hot Gas Reheat	✓
0°F Flooded Condenser Low Ambient Controls	✓
Adjustable Fan Cycling	✓
ECM Controlled Condenser Fans	✓
<b>Serviceability Options</b>	
Sight Glass	✓
Compressor Isolation Valves	✓
<b>Control Options</b>	
Control Circuit Transformer	✓



- ▶ Variable capacity scroll compressors provide load matching cooling and improve part load efficiency.

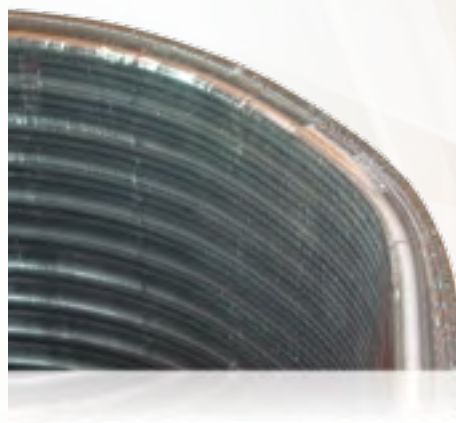

▲ Wrap-around single row condenser coil is easier to clean than multi-row coils.



**Don't see the specific product you need?** AAON can meet your requirements with Custom Equipment designed specifically for your exact application and job specifications. Visit [www.aaon.com/repsearch](http://www.aaon.com/repsearch) or call 918.583.2266 to locate a representative near you.

# AAON QUICK SELECTION

**Airflow (cfm)**

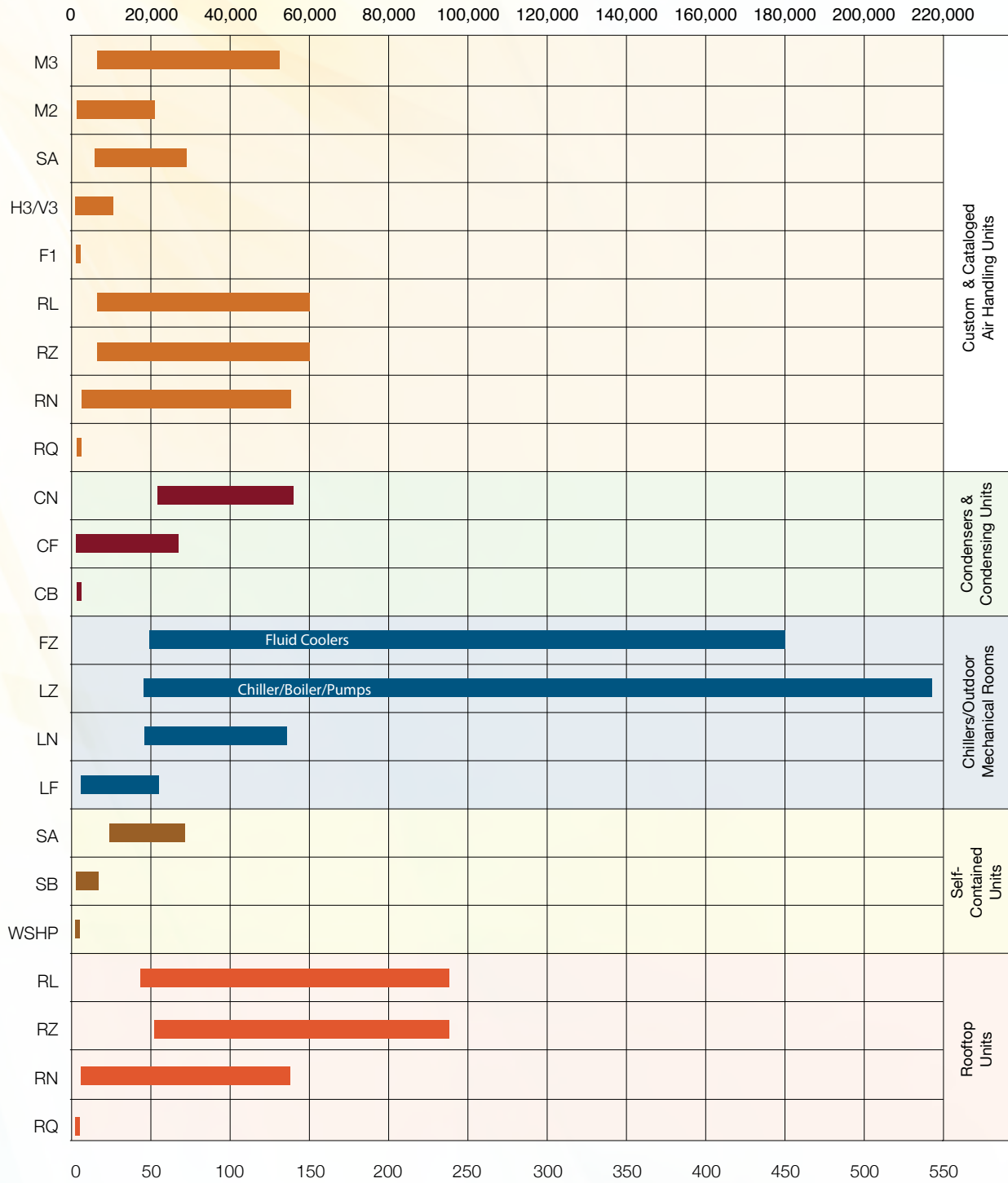

**Nominal Cooling (tons)**



**Don't see the specific product you need?** AAON can meet your requirements with Custom Equipment designed specifically for your exact application and job specifications. Visit [www.aaon.com/repsearch](http://www.aaon.com/repsearch) or call 918.583.2266 to locate a representative near you.



# CHILLERS & OUTDOOR MECHANICAL ROOMS

(Air-Cooled & Evaporative-Cooled)



AAON **OUTDOOR MECHANICAL ROOMS** COMBINE THE ENERGY SAVINGS OF THE AAON LZ SERIES CHILLER, HIGH OUTPUT HEATING CAPACITY OF THE STAND-ALONE BOILER, HIGH OUTPUT CAPACITY OF THE FZ SERIES FLUID COOLER, AND SPACE SAVING FROM INTEGRATED PUMPING PACKAGES. BY COMBINING THE FOUR PRODUCTS INTO THE AAON RIGID POLYURETHANE FOAM CABINET, BUILDINGS RETAIN THE VALUABLE INDOOR SPACE NORMALLY USED FOR THE MECHANICAL ROOM.



► Outdoor Mechanical Room with Evaporative-Cooled Condenser Chiller

- Boiler and pumping package can be included with a chiller system (LZ Series) or within a separate packaged outdoor mechanical room.
- Waterside economizer and pumping package can be included with a new chiller system (LZ Series) or within a stand-alone packaged outdoor mechanical room (FZ Series) for existing systems.
- Units are available with factory installed primary or primary-secondary pumping system with either constant or variable flow configurations.

### Applications

- Air-cooled condenser chillers with capacities from 45-200 tons and evaporative-cooled condenser chillers with capacities from 53-540, for comfort or process cooling requirements.
- Heat pump and water economizer configurations can meet difficult design applications while maintaining high unit efficiencies.
- Factory installed high efficiency (98%) boilers with input capacities from 400 - 6,000 MBH.

### Construction

- The outdoor mechanical room has factory assembled and tested components, piping between pumps and the components, and wiring to accept a single-point electrical connection.
- Designed for outdoor operation, the outdoor mechanical room includes a corrosion resistant paint that exceeds a 2,500 hour salt-spray test.

### Turbocor R-134a Centrifugal Compressors Chillers

LZ Model Chiller Capacity (tons)	Compressors/ Circuits	Condenser Type	Boiler Input Capacity	Waterside Economizer	Width	Height	Length
090	1/1	Air-Cooled	400-6,000 MBH	50-450 tons	142	104	Length varies depending on options selected.
120							
181							
	2/2						
090	1/1	Evaporative-Cooled	400-6,000 MBH	50-450 tons	142	104	Length varies depending on options selected.
120							
150							
180							
181							
240							
300							
	2/2						
360	3/3						
450							
540							

All dimensions are in inches.



**R-410A Scroll Compressor Chillers**

LZ Model Chiller Capacity (tons)	Compressors/ Circuits	Condenser Type	Boiler Input Capacity	Waterside Economizer	Width	Height	Length
045	4/2	Air-Cooled	400-6,000 MBH	50-450 tons	142	104	Length varies depending on options selected.
055							
060							
075							
095							
105							
120							
140							
170	6/3						
200							
053	4/2	Evaporative-Cooled	400-6,000 MBH	50-450 tons	142	104	Length varies depending on options selected.
061							
069							
078							
106							
121							
134							
161							
193	6/3						
239							
274	8/4						
319							
356	10/5					106	
401							
441	12/6						
478							

*All dimensions are in inches.*

- Paint can be specified in a variety of colors to enhance the aesthetics of visible units.
- Double wall cabinets utilize thermal breaks and closed-cell polyurethane in its rigid polyurethane foam panels to increase thermal resistance, reinforce structural integrity, and attenuate radiated sound.
- Compressors are installed on structural decks and rubber isolation mounted for quiet and efficient operation.
- Factory installed, microprocessor controlled three-chemical water treatment system has chemical dispensers for evaporative-cooled designs. This water treatment system saves installation time, field engineering, and improves equipment durability.
- Hinged access doors are provided in areas subject to scheduled maintenance. Walk-in doors are constructed with stainless steel piano hinges, perimeter gaskets and zinc cast lockable handles. Doors operate from a single point and open from the outside or inside of the cabinet.
- Interior of evaporative-cooled condenser is constructed of 304 stainless steel and other non-corrosive materials.

# Chiller + Boiler + Pumps + Controls = Package Savings

## Evaporative-Cooled Condenser

Factory installed evaporative-cooled condenser is available for ambient wet bulb condensing. AAON engineered evaporative-cooled condenser, with air-cooled de-superheater and VFD controlled variable speed condenser fans, uses 22-100% less water than a conventional evaporative-cooled condenser and require 22-100% less chemical usage than a conventional evaporative-cooled condenser. Interior of evaporative-cooled condenser is constructed of 304 stainless steel and other non-corrosive materials. De-superheater coils include polymer e-coating for corrosion protection.

AAON evaporative-cooled condensing saves costs when compared with a water-cooled chiller system because the water treatment system is factory installed and evaporative-cooled condensing does not require field installation of a cooling tower or condenser water pumping.

**The Evaporative-Cooled Condenser LZ Series with Turbocor Compressors is the most energy efficient chiller available.** It eliminates the water-to-water heat exchanger required in conventional chilled water systems, because the refrigerant gas is directly cooled by the condenser water and air. The oil-free compressor design allows the system to provide ultra high efficiency cooling at all conditions.

### 540 ton Outdoor Mechanical Room with Turbocor Compressors

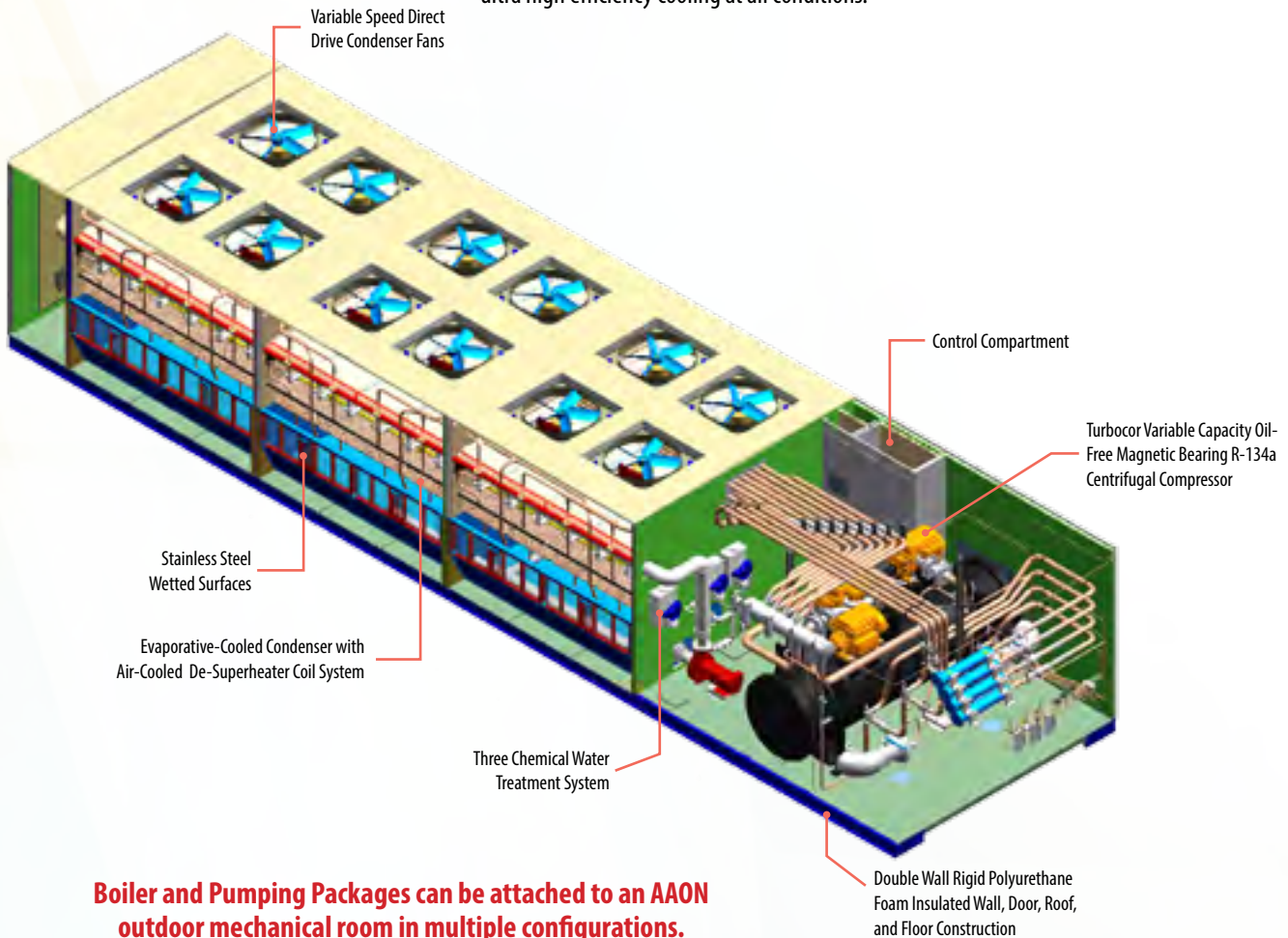

**Boiler and Pumping Packages can be attached to an AAON outdoor mechanical room in multiple configurations.**

# Waterside Economizer = Free Cooling

**200 ton Outdoor Mechanical Room with Air-Cooled Condenser, Scroll Compressors, and Waterside Economizer**

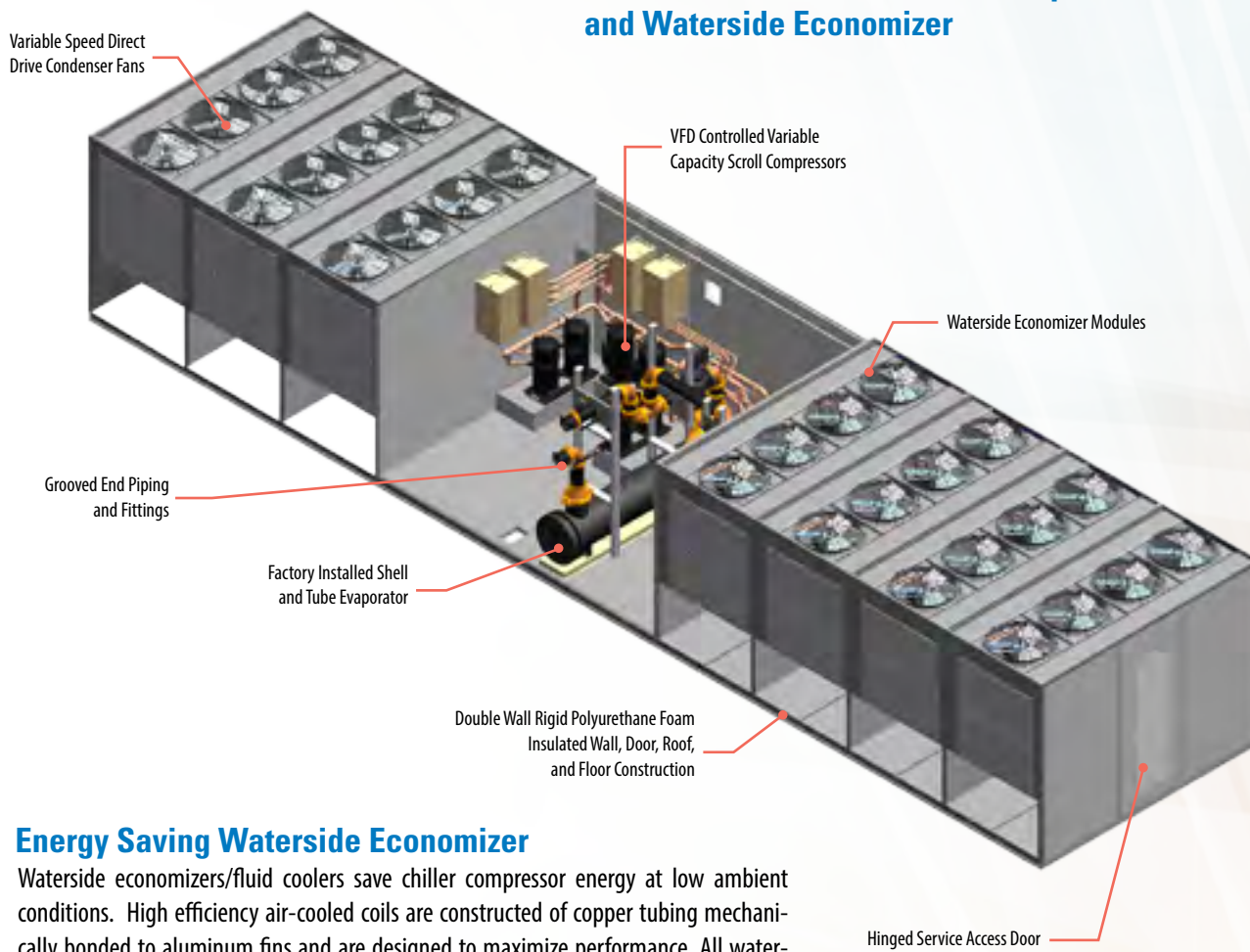

## Energy Saving Waterside Economizer

Waterside economizers/fluid coolers save chiller compressor energy at low ambient conditions. High efficiency air-cooled coils are constructed of copper tubing mechanically bonded to aluminum fins and are designed to maximize performance. All waterside economizers can be selected with VFD controlled fans that save energy costs and reduce sound levels. Isolated modular construction of the waterside economizer allows each module's fans to be controlled independently. Modular construction also allows matching the capacity to the application requirements

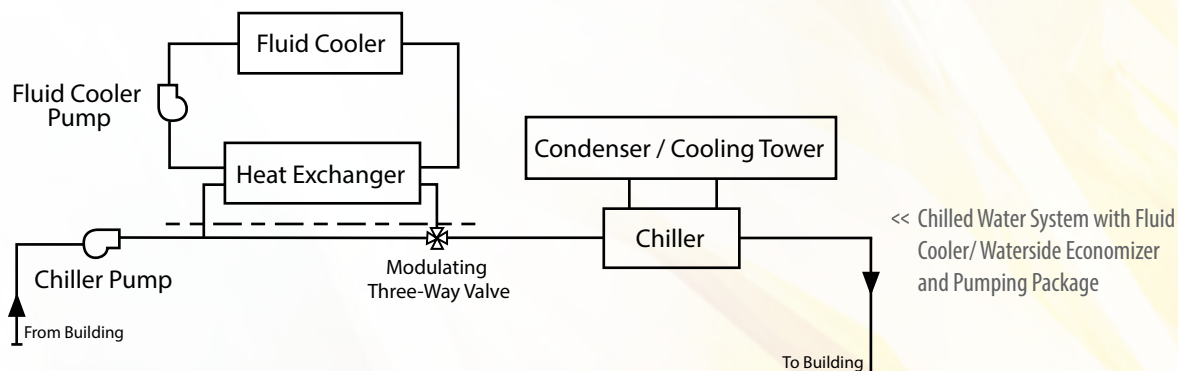



## Pumps

- Constant or variable flow pump systems can be factory installed in the outdoor mechanical room. This saves valuable interior building space by eliminating pumps in the indoor mechanical room.
- All pump packages include a optional factory installed strainer, pump, combination valve (isolation, check, and flow balancing) in the water system, and optional factory installed in-line air separator.
- Outdoor mechanical rooms can include DualArm pumps for system redundancy.

▶ Staged or VFD Controlled Variable Speed Scroll Compressor



## Features and Options

- VFD controlled variable speed R-410A scroll compressors and Turbocor variable capacity oil-free magnetic bearing R-134a centrifugal compressors are available for load matching cooling capabilities and increased part load efficiency.
- Insulated shell and tube or brazed plate evaporators are factory installed in each unit.
- Service and control walk-in vestibule can be independently heated and/or cooled for comfort while periodic maintenance is performed on the unit.
- Factory installed option boxes increase unit space for field installed components or for increased interior working area.
- Variable speed condenser fans are available to increase unit efficiency at part-load and low ambient conditions, increase operating temperature range, and reduce sound levels.
- Glycol chillers for refrigeration applications.
- Polymer e-coated condenser coils can be specified to extend the life of the coils and protect them in corrosive environments.
- Optional factory installed compressor isolation valves and water system thermometers and pressure gauges save installation time at the job site.
- Diaphragm expansion/compression tanks can be pre-engineered and factory installed.

## Variable Capacity Scroll Compressors

LZ Series chillers are available with variable capacity compressors which allow the chiller to be able to provide a consistent leaving water temperature at all operating conditions. VFD controlled variable speed R-410A scroll compressors are available for load matching cooling capabilities and increased part load efficiency. Turbocor variable capacity R-134a centrifugal compressors provide load matching cooling capabilities, with quiet energy efficient operation. During part load operation, reducing compressor capacity saves system operating costs. Low turndown capabilities minimize the water loop volume required to maintain a stable setpoint temperature.

## Microchannel Condenser

Air-cooled condenser LZ Series units are designed with microchannel condenser coils that are more efficient, lighter, and use less refrigerant than traditional fin and tube condenser coils. Microchannel coils are more efficient due to their enhanced heat transfer. They are also up to 30 percent lighter than fin and tube coils.



▶ Turbocor Oil-Free Magnetic Bearing Variable Capacity Centrifugal Compressor



## Controls

- Microprocessor controls are compatible with BACnet IP, BACnet MSTP, Modbus IP, Modbus RTU, and LonTalk protocols.
- Microprocessor controller cycles boilers to maintain the leaving water temperature to within 3°F of setpoint.
- Unit wiring is completely factory provided with color-coded wires. Units are provided with specific, color-coded wiring diagrams. Diagrams are laminated and permanently affixed inside control compartment access door.
- Control components are labeled to simplify service and scheduled maintenance.
- Factory run test and inspection reports are included in the documentation compartment affixed to the interior of the control compartment access door.
- Compressors and controls are accessed through service vestibules that shield components and service personnel from weather and outdoor elements.
- MCS Magnum Controller Touchscreen Computer Interface allows monitoring and adjustment of the complete hydronic system.



- ▶ Factory installed glycol feeder allows glycol to be easily added to the fluid loop to help prevent freezing at low ambient temperatures.



## Factory Installed 98% Efficiency Condensing Boilers

- Factory installed natural gas condensing boilers, with input capacities from 400–6,000 MBH, save interior mechanical room space and provide energy efficient heat.
- One to four boilers, in 400, 500, 600, 700, 750, 800, 1,000, 1,300, and 1,500 MBH input capacities, are available within a single LZ Series outdoor mechanical room for extra capacity or redundancy.
- Both 20°F and 40°F temperature change boilers are available for application flexibility.
- The condensing boilers operate with up to a 98% thermal efficiency, a fully modulating burner and a low NOx rating.
- The boiler heat exchanger is constructed of stainless steel and the burner includes direct-spark ignition.
- Boilers also include factory provided controls with a built-in cascading sequencer to optimizer operation.

## Factory Installed Waterside Economizers

- Factory installed waterside economizers, with inputs from 50–450 tons, provide additional cooling in low ambient conditions.
- Energy saving waterside economizer for new or existing chilled water systems.

- ▶ 98% Efficiency Condensing Boiler

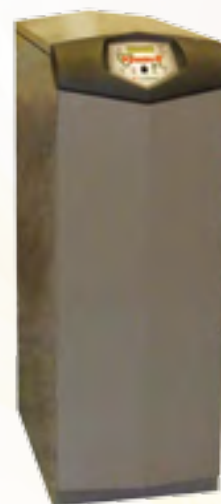



# LZ Series

	R-410A Scroll Compressor Units (45 - 478 tons)	Turbocor R-134a Centrifugal Compressor Units (90 - 540 tons)
<b>Cooling Options</b>		
Staged On/Off Scroll Compressors	✓	
VFD Controlled Variable Capacity Scroll Compressors	✓	
Oil-Free Magnetic Bearing Centrifugal Compressors		✓
Air-Cooled Microchannel Condenser	45-200 = ✓	90-181 = ✓
Evaporative-Cooled Condenser	53-478 = ✓	✓
Polymer E-Coated Microchannel Condenser Coils	✓	✓
Brazed Plate Evaporator	45-140 = ✓	
Shell & Tube Evaporator	✓	✓
Waterside Economizer	✓	✓
Chiller Pumping Package	✓	
<b>Heating Options</b>		
98% Efficiency Condensing Boilers	✓	✓
Boiler Pumping Package	✓	✓
<b>Pumping Package Options</b>		
Constant Flow Primary Pumping	✓	✓
Variable Flow Primary Pumping	✓	✓
Primary/Secondary Pumping	✓	✓
Single Pump with VFD Control	✓	✓
Two Single Pumps with VFD Control	✓	✓
DualArm Pumps with VFD Control	✓	✓
<b>Serviceability Options</b>		
Factory Wired Convenience Outlet	✓	✓
Compressor Isolation Valves	✓	✓
Service Lights	✓	✓
Refrigerant Leak Detector	✓	✓
Service Vestibule Heating	✓	✓
Service Vestibule Cooling	✓	✓
Non-Fused Disconnect Switch	✓	✓

# LZ Series

	R-410A Scroll Compressor Units (45 - 478 tons)	Turbocor R-134a Centrifugal Compressor Units (90 - 540 tons)
<b>Refrigeration Options</b>		
Sight Glass	✓	✓
VFD Controlled Condenser Fans	✓	✓
Head Pressure Control	✓	✓
Low Ambient Operation	✓	✓
<b>Control Options</b>		
BACnet IP or MSTP	✓	✓
Modbus IP or RTU	✓	✓
LonTalk	✓	✓
Touchscreen Computer Interface	✓	✓
Chiller Diagnostics	✓	✓
Modem	✓	✓
<b>Chiller Accessories</b>		
Glycol Chiller	✓	✓
Air Separator	✓	✓
Thermometers & Pressure Gauges	✓	✓
Chemical Pot Feeder	✓	✓
Auto Glycol Feeder	✓	✓
Chiller Compression Tank	✓	✓
Boiler Compression Tank	✓	✓
<b>Construction Options</b>		
Access Door Windows	✓	✓
Special Exterior Paint Color	✓	✓
Single or Two Piece Unit	✓	✓
Condenser Coil Guards	✓	✓
<b>Code Options</b>		
Chicago Code	✓	✓



AAON **BOILER OUTDOOR MECHANICAL ROOMS** INCLUDE ENERGY SAVING 98% THERMAL EFFICIENCY BOILERS AND FACTORY INSTALLED BOILER PUMPING PACKAGES. BY COMBINING THE COMPLETE BOILER SYSTEM INTO A RIGID POLYURETHANE FOAM CABINET, BUILDINGS CAN RETAIN THE VALUABLE INDOOR SPACE NORMALLY USED FOR THE



▶ Outdoor Mechanical Room with Boilers and Pumping Package

### Features

- 400-6,000 MBH capacity is available in a single packaged unit.
- Multiple boilers can be included in one package for extra capacity or redundancy.
- High and low flow models are available depending on the temperature rise needed for the application.
- Factory engineered and installed water pumping packages reduce field installation labor and materials.
- Double wall foam insulated cabinet construction creates exterior mechanical room saving valuable interior space.
- Interior service lights in the walk-in controls and service vestibule provides year round service access.
- Access doors with stainless steel full length piano hinges and lockable handles offers reliability and security.



**Don't see the specific product you need?** AAON can meet your requirements with Custom Equipment designed specifically for your exact application and job specifications. Visit [www.aaon.com/repsearch](http://www.aaon.com/repsearch) or call 918.583.2266 to locate a representative near you.



# BL Series

	Boiler Units (500-6,000 MBH)
<b>Heating Options</b>	
98% Efficiency Condensing Natural Gas Boilers	✓
Boiler Pumping Package	✓
<b>Pumping Package Options</b>	
Single Pump with VFD Control	✓
Two Single Pumps with VFD Control	✓
DualArm Pumps with VFD Control	✓
<b>Serviceability Options</b>	
Factory Wired Convenience Outlet	✓
Service Vestibule Heating	✓
<b>Control Options</b>	
BACnet IP or MSTP	✓
Modbus IP or RTU	✓
LonTalk	✓
Touchscreen Computer Interface	✓
Chiller Diagnostics	✓
Modem	✓
<b>Boiler Accessories</b>	
Glycol Boiler	✓
Thermometers & Pressure Gauges	✓
Boiler Compression Tank	✓
<b>Construction Options</b>	
Access Door Windows	✓
Special Exterior Paint Color	✓



▶ Walk-in Service Access

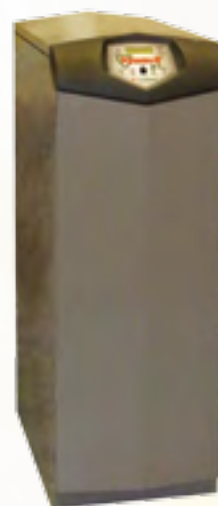

◀ 98% Efficiency Condensing Boiler



AAON **FZ SERIES FLUID COOLERS** COMBINE THE ENERGY SAVINGS OF THE HIGH OUTPUT CAPACITY OF THE STAND-ALONE WATERSIDE ECONOMIZER AND SPACE SAVING FROM INTEGRATED PUMPING PACKAGES. BY COMBINING THESE TWO PRODUCTS INTO THE AAON RIGID POLYURETHANE FOAM CABINET, BUILDINGS RETAIN THE VALUABLE INDOOR SPACE NORMALLY USED FOR THE MECHANICAL ROOM.

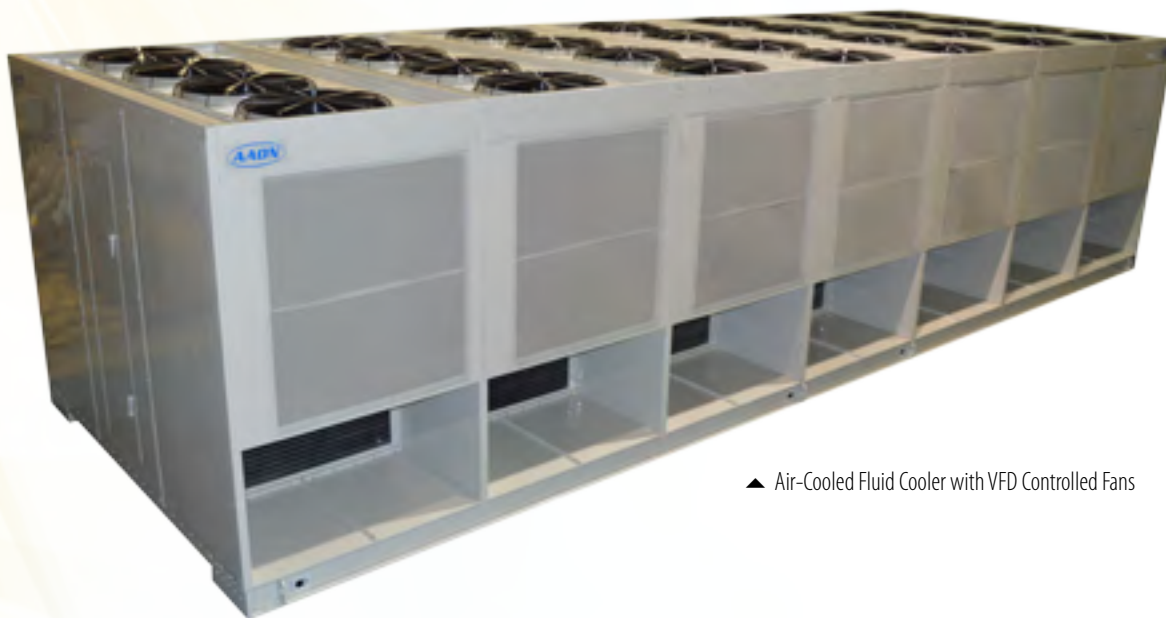

▲ Air-Cooled Fluid Cooler with VFD Controlled Fans

### Features

- 50-450 ton capacity is available in a single packaged unit.
- Energy saving waterside economizer for new or existing chilled water systems.
- Modular construction allows matching capacity to the application requirements.
- Isolated modules allow independent fan control for each module.
- Double wall foam insulated cabinet construction creates exterior mechanical room saving valuable interior space.
- Service access doors with full length stainless steel piano hinges and zinc cast lockable handles offers reliability and security.
- Available with VFD controlled variable speed fans.
- Available with factory engineered and installed pumping packages.
- Available with water-to-glycol heat exchanger isolation.

# FZ Series

## FZ Fluid Cooler (50-450 tons)

Cooling Options	
Water-to-Glycol Heat Exchanger Isolation	✓
Pumping Options	
Fluid Cooler Recirculating Pump	✓
Building Pump	✓
Single Pump with VFD	✓
Two Single Pumps with VFD	✓
DualArm Pumps with VFD	✓
Serviceability Options	
Factory Wired Convenience Outlet	✓
Service Pumping and Controls Vestibule	✓
Isolation Valves on Each Coil	✓
Balancing Valve on Each Coil	✓
Service Lights	✓
Service Vestibule Heating	✓
Control Options	
BACnet IP or MSTP	✓
Modbus IP or RTU	✓
LonTalk	✓
VFD Controlled Fans	✓
Premium VFD on All Motors	✓
Touchscreen Computer Interface	✓
Modem	✓
Coil and Piping Accessories Options	
Thermometers & Pressure Gauges	✓
Auto Glycol Feeder	✓
Air Separator on Building pump	✓
Chemical Pot Feeder	✓
Compression Tank	✓



▲ Walk-in Service Access



▲ 75 ton Fluid Cooler



### Don't see the specific product you need?

AAON can meet your requirements with Custom Equipment designed specifically for your exact application and job specifications. Visit [www.aaon.com/repsearch](http://www.aaon.com/repsearch) or call 918.583.2266 to locate a representative near you.



AAON **LN SERIES CHILLERS AND OUTDOOR MECHANICAL ROOMS** ARE ENGINEERED FOR PERFORMANCE AND SERVICEABILITY. VARIABLE CAPACITY COMPRESSORS AND A HIGH EFFICIENCY AIR-COOLED CONDENSER MAXIMIZE PERFORMANCE. ALL MODELS FEATURE DOUBLE WALL RIGID POLYURETHANE FOAM PANEL CONSTRUCTION WITH SERVICE COMPARTMENTS WHICH ALLOW MAXIMUM ACCESSIBILITY WHILE INSTALLING AND MAINTAINING THE EQUIPMENT. THE CHILLER CAN ALSO BE PROVIDED WITH FACTORY ENGINEERED AND INSTALLED PUMPING PACKAGES, ELIMINATING THE NEED FOR AN INDOOR MECHANICAL ROOM.

### Applications

- Air-cooled condenser chillers and outdoor mechanical rooms with capacities from 45-140 tons.
- Units are available with factory installed primary pumping system with either constant or variable flow configurations.
- Units are available with shell and tube or brazed plate heat exchangers.
- Tandem VFD controlled R-410A scroll compressors provide low load operation and high efficiencies during part and full loads.
- Microchannel air-cooled condenser design is the most efficient chiller design available. Small condenser fans and small motors are designed for ultra quiet operation.

### Construction

- The outdoor mechanical room has factory assembled and tested components, piping between pumps and the components, and wiring to accept a single-point electrical connection.
- Designed for outdoor operation, the outdoor mechanical room includes a corrosion resistant paint that exceeds a 2,500 hour salt-spray test.
- Paint can be specified in a variety of colors to enhance the aesthetics of visible units.



▲ LN Series Chillers

- Double wall cabinets utilize thermal breaks and closed-cell polyurethane in its rigid polyurethane foam panels to increase thermal resistance, reinforce structural integrity, and attenuate radiated sound.
- Standard perforated metal condenser coil guards help protect condenser coils from damage.
- Scroll compressors are installed on structural decks and rubber isolation mounted for quiet and efficient operation.
- Hinged access doors are provided in areas subject to scheduled maintenance. Walk-in doors are constructed with stainless steel piano hinges, perimeter gaskets and zinc cast lockable handles. Doors operate from a single point and open from the outside or inside of the cabinet.

LN Model	Cabinet	Compressors/Circuits	Width	Height	Length
045	A	4/2	142	104	120
055					
060					
075	B				182
095					
105	C				
120					
140					

All dimensions are in inches.



## Pumps

- Constant or variable flow pump systems can be factory installed in the outdoor mechanical room. This saves valuable interior building space by eliminating pumps in the indoor mechanical room.
- All pump packages include a factory installed pump, strainer, butterfly valves, and combination valve (isolation, check, and flow balancing) in the water system.
- Outdoor mechanical rooms can include DualArm pumps for system redundancy.
- Factory engineered and mounted water pumping systems reduce total installation costs compared with field engineered and installed water pumping systems.

## Features and Options

- Variable capacity scroll compressors are available with load matching cooling and greater efficiency than on/off compressors. With tighter capacity control, a precise setpoint temperature is maintained while loop volume and storage tank requirements are drastically reduced or eliminated. A reduced loop volume also saves energy during startups.
- Evaporator options include insulated shell and tube or brazed plate exchangers as standard or oversized.
- Control and compressor compartment is isolated from the water system for easy service and scheduled maintenance.
- Units incorporate VFD driven condenser fans to increase unit efficiency at part-load and low ambient conditions, increase operation temperature range, and reduce sound levels.

Factory installed pumping package eliminates the need for an indoor mechanical room.



▲ Evaporator and Pumping Package Service Compartment

- VFD controlled condenser fan low ambient option allows mechanical cooling down to 0°F.
- Polymer e-coated condenser coils can be specified to extend the life of the coils and protect them in corrosive environments.
- Optional factory installed compressor isolation valves, water system thermometers and pressure gauges reduce maintenance hours.
- Thermostat controlled electric heater in the evaporator and pumping package compartment can be used as an alternative to more expensive systems that use glycol for freeze protection.

## Controls

- Microprocessor controls are compatible with BACnet®, Modbus, and LonTalk® protocols.
- Unit wiring is completely factory installed with specific, color-coded wiring diagrams. Diagrams are laminated and permanently affixed inside control compartment access door.
- Control components are labeled to simplify service and scheduled maintenance.
- Factory run test and inspection reports are included in the documentation compartment affixed to the interior of the control compartment access door.



- ▶ Microchannel condenser coils are durable, more efficient, lighter, and use less refrigerant than traditional fin and tube condenser coils.

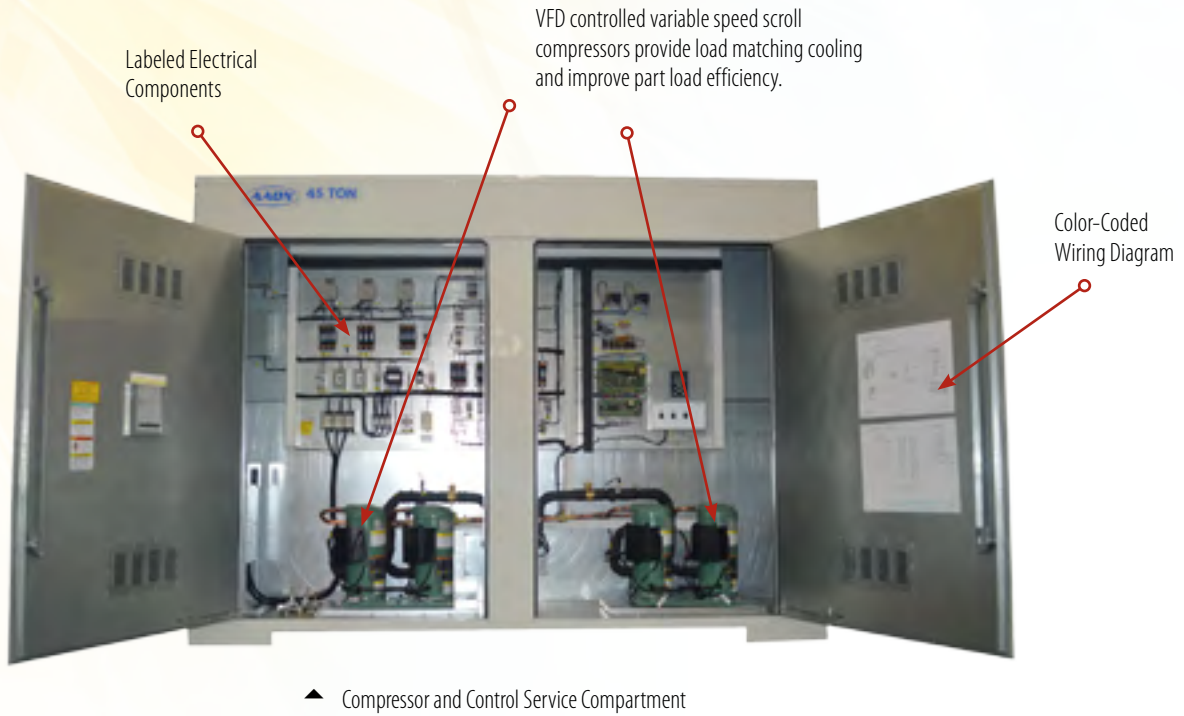

▲ Compressor and Control Service Compartment

### Variable Capacity Scroll Compressors

LN Series units are available with staged or lead VFD controlled variable speed scroll compressors that can modulate compressor capacity. This allows the system to maintain consistent leaving water temperatures at all operating conditions. During part load operation, reducing compressor capacity increases part load efficiency and ultimately saves valuable system operating costs. LN Series units are also available with VFD controlled compressors on all circuits to maximize energy savings.

### Microchannel Condenser

LN Series units are designed with microchannel condenser coils that are more efficient, lighter, and use less refrigerant than traditional fin and tube condenser coils. Microchannel coils are more efficient due to their enhanced heat transfer. They are also up to 30 percent lighter than fin and tube coils.

### Pumping Package

LN Series units can be delivered to the job completely ready for installation, saving time and money. The factory installed pumping package includes primary pumping with either a single pump or DualArm redundant pumps. Evaporator and pumping package are housed in a double wall, rigid polyurethane foam insulated service compartment that can be provided with auxiliary electric heating. Primary pumping package includes pump, strainer located before the pump, combination valve located directly after the pump, and butterfly valves at the unit connections.



**Don't see the specific product you need?** AAON can meet your requirements with Custom Equipment designed specifically for your exact application and job specifications. Visit [www.aaon.com/repsearch](http://www.aaon.com/repsearch) or call 918.583.2266 to locate a representative near you.

# LN Series

	A Cabinet (45-60 tons)	B Cabinet (75 tons)	C Cabinet (95-140 tons)
<b>Cooling Options</b>			
Staged On/Off Scroll Compressors	✓	✓	✓
VFD Controlled Variable Capacity Scroll Compressors	✓	✓	✓
Air-Cooled Microchannel Condenser	✓	✓	✓
Polymer E-Coated Condenser Coils	✓	✓	✓
Brazed Plate Evaporator	✓	✓	✓
Shell & Tube Evaporator	✓	✓	✓
<b>Pumping Options</b>			
Constant Flow Primary Pumping	✓	✓	✓
Variable Flow Primary Pumping	✓	✓	✓
Single Pump with VFD	✓	✓	✓
DualArm Pumps with VFD	✓	✓	✓
<b>Serviceability Options</b>			
Factory Wired Convenience Outlet	✓	✓	✓
Compressor Isolation Valves	✓	✓	✓
Service Lights	✓	✓	✓
Service Vestibule Heating	✓	✓	✓
Non-Fused Disconnect Power Switch	✓	✓	✓
<b>Refrigeration Options</b>			
Low Ambient Operation	✓	✓	✓
Sight Glass	✓	✓	✓
VFD Controlled Condenser Fans	✓	✓	✓
Fan Cycling	✓	✓	✓
<b>Control Options</b>			
BACnet IP or MSTP	✓	✓	✓
Modbus IP or RTU	✓	✓	✓
LonTalk	✓	✓	✓
Touchscreen Computer Interface	✓	✓	✓
Chiller Diagnostics	✓	✓	✓
Modem	✓	✓	✓
<b>Chiller Accessories Options</b>			
Glycol Chiller	✓	✓	✓
Thermometers & Pressure Gauges	✓	✓	✓
<b>Code Options</b>			
Chicago Code	✓	✓	✓



AAON **LF SERIES CHILLERS** ARE DESIGNED FOR PERFORMANCE AND SERVICEABILITY. THE CHILLER CAN BE PROVIDED WITH FACTORY ENGINEERED AND INSTALLED PUMPING PACKAGES, ELIMINATING THE NEED FOR A MECHANICAL ROOM. FOR IMPROVED PART LOAD EFFICIENCY AND CONSISTENT LEAVING WATER TEMPERATURE LF SERIES CHILLERS CAN INCLUDE VARIABLE CAPACITY SCROLL COMPRESSORS. EACH LF SERIES CHILLER IS FACTORY TESTED TO INSURE PROPER OPERATION IN THE FIELD.



◀ LF Series Chiller

### Applications

- Air-cooled condenser chillers with capacities from 4-55 tons
- Variable capacity R-410A scroll compressors for load matching cooling and improved part load efficiency
- High efficiency microchannel condenser coils
- Shell and tube or brazed plate heat exchangers
- High efficiency variable speed VFD controlled or ECM driven condenser fans

### Construction

- Service access doors with full length stainless steel piano hinges and lockable handles
- Labeled controls components with color-coded wiring that matched the unit wiring diagram included in the control compartment
- Factory installed DDC controller compatible with BACnet®, Modbus®, and LonTalk®



## Features and Options

- 10-100% variable capacity R-410A scroll compressors allow for part load matching cooling and better efficiency than on/off compressors.
- Compressors are factory installed on structural decks and rubber isolation mounts for quiet operation.
- Evaporator options include shell and tube or brazed plate exchangers as standard or oversized.
- Condenser coil is high efficiency microchannel.
- VFD controlled or electronically commutated motor (ECM) driven condenser fans create a wider ambient temperature operating range, increase part load efficiency, and minimize radiated sound.
- Crankcase heaters prevent liquid from settling in the compressors during low ambient conditions.
- Run test report, color-coded wiring diagram, and Installation, Operation, and Maintenance manual with start-up form are provided in the control compartment.
- Polymer e-coated condenser coils are available to extend the life of the coils and protect them in corrosive environments.
- Optional factory installed pumping packages can save interior mechanical room building space.
- Flooded condenser low ambient control allows cooling at ambient temperatures down to 0°F.
- Thermostat controlled electric heater in the evaporator and pumping package compartment can be used as an alternative to more expensive systems that use glycol for freeze protection.
- 5 year non-prorated compressor warranty.

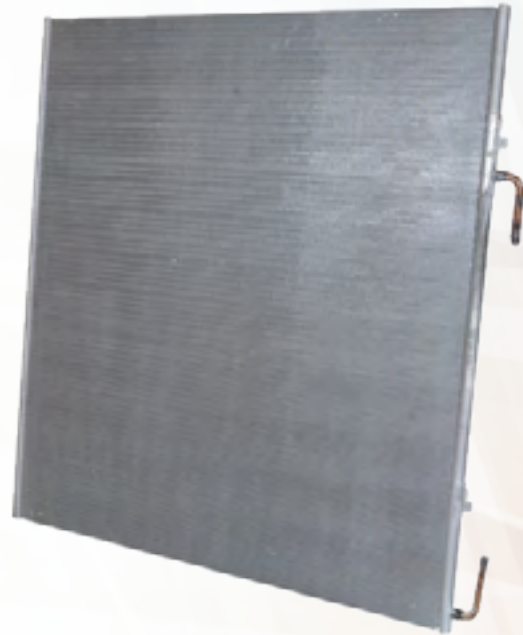

▲ Microchannel condenser coils are more efficient, lighter, and use less refrigerant than traditional fin and tube condenser coils.

◀ Compressor and control service compartment reduces installation and service time.



**Don't see the specific product you need?** AAON can meet your requirements with Custom Equipment designed specifically for your exact application and job specifications. Visit [www.aaon.com/repsearch](http://www.aaon.com/repsearch) or call 918.583.2266 to locate a representative near you.



### Air-Cooled Condenser

LF Series units are designed with microchannel condenser coils that are more efficient, lighter, and use less refrigerant than traditional fin and tube condenser coils. Microchannel coils are more efficient due to their enhanced heat transfer. They are also up to 30 percent lighter than fin and tube coils.

### Heat Exchangers

Factory installed and insulated shell and tube heat exchangers and factory installed and insulated brazed plated heat exchangers are available with LF Series chillers.

### Factory Installed Pumping Packages

Optional pumping package includes a pump, strainer, butterfly valve, isolation valve, check valve, and flow balancing valve. Grooved end and fittings are provided in all LF Series chillers. AAON ECat selection software allows quick and easy selection of proper pumping package components and includes pump performance curves and piping diagram.

### Variable Capacity Scroll Compressors

All LF Series chillers include 10-100% variable capacity scroll compressors that modulate capacity. This allows the system to maintain consistent leaving water temperatures at all operating conditions. During part load operation, reducing compressor capacity increases part load efficiency and saves valuable system operating costs.

### AAON Chillers

AAON LF Series chillers are available from 4-55 tons, AAON LN Series chillers are available from 45-140 tons, and AAON LZ Series chillers are available from 45-540 tons. LF and LN Series chillers are available with R-410A scroll compressors. LZ Series chillers are available from 45-478 tons with R-410A scroll compressors. LZ Series chillers are also available from 90-540 tons with Turbocor R-134a centrifugal compressors.

LF Model	Cabinet	Compressors/ Circuits	Width Base	Width Top	Height	Length
004	A	1/1	32	69	44	85
005						
007						
009						
008	B		45	80	51	90
010						
011						
013						
014	C	2/2	50	87	60	111
015						
017						
022						
024						
021	D	4/2 or 4/4	143	176	68	80
026						
031						
042						
048						
055						

All dimensions are in inches.

	A Cabinet (4-7 & 9 tons)	B Cabinet (8 & 10-13 tons)	C Cabinet (14-17 & 22-24 tons)	D Cabinet (21 & 26-55 tons)
<b>Cooling Options</b>				
10-100% Variable Capacity Compressors	✓	✓	✓	✓
High Efficiency Air-Cooled Microchannel Condenser Coil	✓	✓	✓	✓
Polymer E-Coated Condenser Coils	✓	✓	✓	✓
Brazed Plate Evaporator	✓	✓	✓	✓
Shell & Tube Evaporator	✓	✓	✓	✓
<b>Pumping Options</b>				
Constant Flow Primary Pumping	✓	✓	✓	✓
Variable Flow Primary Pumping	✓	✓	✓	✓
VFD Controlled Single Pump	✓	✓	✓	✓
VFD Controlled DualArm Pump		✓	✓	✓
<b>Serviceability Options</b>				
Single Point Non-Fused Disconnect	✓	✓	✓	✓
Compressor Isolation Valves	✓	✓	✓	✓
115VAC Convenience Outlet	✓	✓	✓	✓
Service Access Lights	✓	✓	✓	✓
<b>Refrigeration Options</b>				
0° F Flooded Condenser Low Ambient Controls	✓	✓	✓	✓
VFD Controlled Condenser Fans	✓	✓	✓	✓
ECM Driven Condenser Fans	✓	✓	✓	✓
Sight Glass	✓	✓	✓	✓
Glycol Chiller	✓	✓	✓	✓
<b>Control Options</b>				
BACnet IP or MSTP	✓	✓	✓	✓
Modbus IP or RTU	✓	✓	✓	✓
LonTalk	✓	✓	✓	✓
Chiller Diagnostics	✓	✓	✓	✓
Modem	✓	✓	✓	✓
<b>Cabinet Options</b>				
Compressor Sound Blanket	✓	✓	✓	✓
Service Vestibule Electric Heating	✓	✓	✓	✓
Condenser Coil Guards	✓	✓	✓	✓
<b>Safety Options</b>				
Phase and Brownout Protection	✓	✓	✓	✓

A,B,C Cabinets

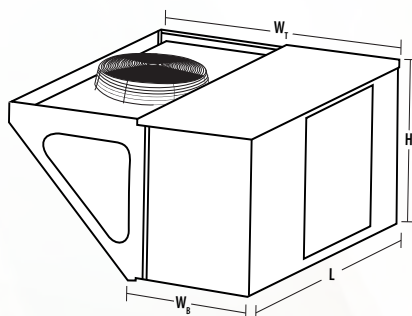

D Cabinet

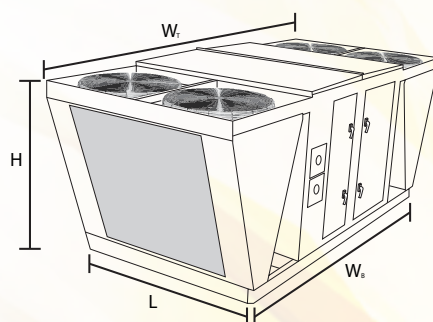

# AAON QUICK SELECTION

**Airflow (cfm)**

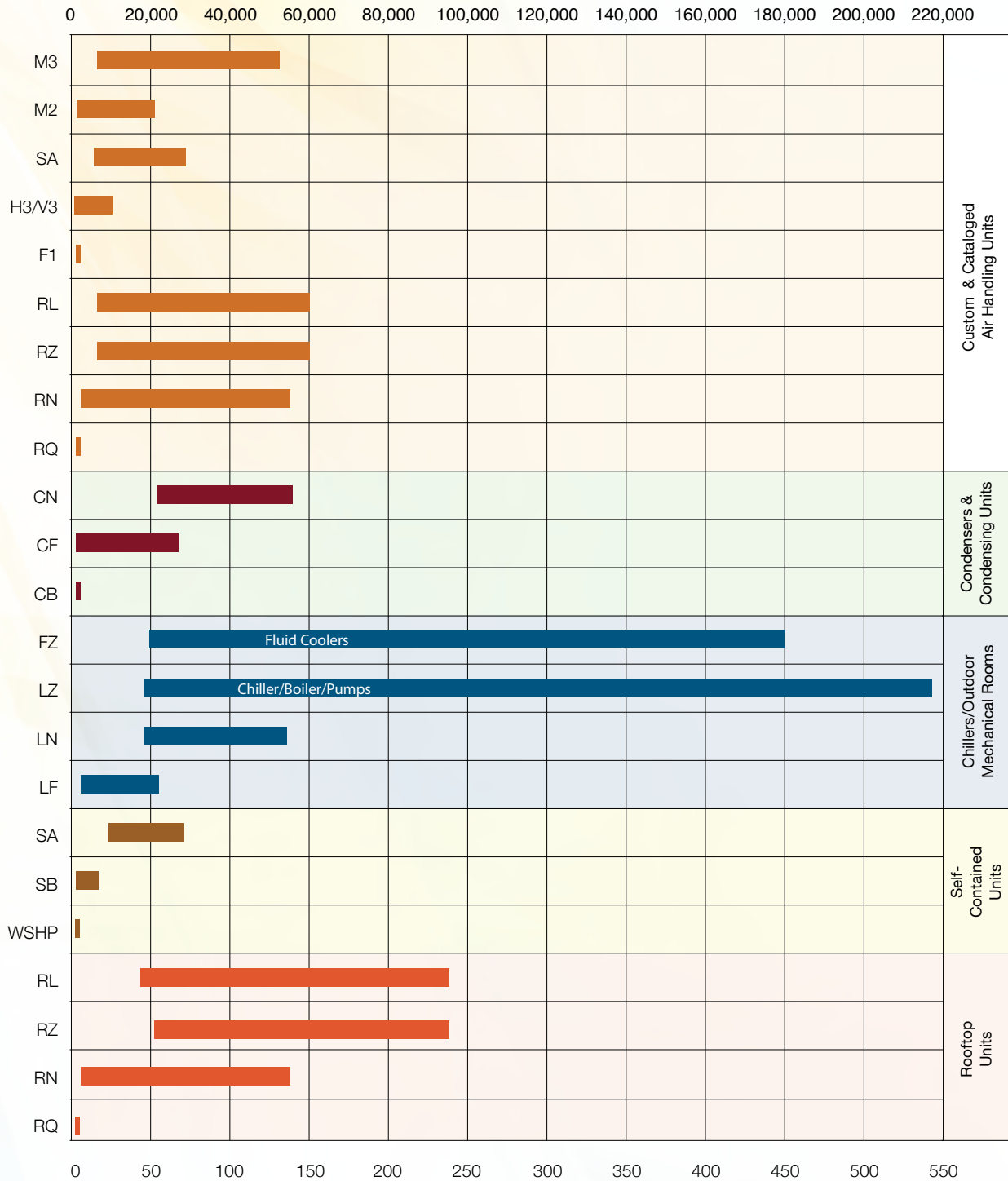

**Nominal Cooling (tons)**



**Don't see the specific product you need?** AAON can meet your requirements with Custom Equipment designed specifically for your exact application and job specifications. Visit [www.aon.com/repsearch](http://www.aon.com/repsearch) or call 918.583.2266 to locate a representative near you.



# SELF-CONTAINED UNITS

(Water-Cooled & Heat Pumps)



AAON **M2 SERIES MODULAR SELF-CONTAINED UNITS** UTILIZE QUALITY CONSTRUCTION TO PROVIDE LOW AIR LEAKAGE, MINIMAL RADIATED NOISE, AND SERVICEABILITY. THE MODULAR CABINET DESIGN ADAPTS TO COMPLEX ENGINEERING CHALLENGES, WHILE REMAINING EASY TO INSTALL AND SERVICE.

### Water-Source and Geothermal

- Water-source and geothermal heat pump self-contained unit from 3-70 tons and 1,000-21,600 cfm.
- Units can be factory assembled or shipped as split modules for retrofit applications.
- 10-100% variable capacity R-410A scroll compressors provide load matching cooling and heat pump heating and improved part load efficiency.
- Makeup air capability, up to 100% outside air, to meet ventilation requirements.
- Factory installed high performance electric, indirect gas-fired, hot water, or steam heating.

### Construction

- The M2 Series modular design provides easy installation at the job site. Unit modules may be factory assembled to prevent unnecessary lifting at the job site or shipped separately for job site maneuverability.
- Double wall cabinets utilize thermal breaks and closed-cell polyurethane foam to increase thermal resistance, improve air seals, inhibit microbial growth, reinforce structural integrity, and attenuate radiated sound.
- Rigid polyurethane foam panels, high quality sealing, and double wall doors save operating costs by reducing the unfiltered and unconditioned air leakage.
- Access into fan, filter, coil, and compressor sections is quick and easy through double wall rigid polyurethane foam panels. The panels have chrome plated steel hinges and quarter turn, zinc cast, lockable handles for effortless entry and removable hinge pins for access in compact spaces.
- Selectable base rail height allows for condensate trapping and eliminates the need for a costly housekeeping pad.
- Sloped stainless steel drain pans eliminate standing water which can support microbial growth and stainless steel construction prevents corrosion that could lead to water leaks and contaminants in the air stream.



▲ M2 Series self-contained unit with factory installed energy recovery wheel.

### Fans and Blowers

- Fans and blowers are individually selected to match external static, sound, efficiency, and space design criteria as specified. Blowers are backward curved single thickness airfoil centrifugal plenum style. Blowers with backward curved blades are generally quieter and more efficient than forward curved blowers.
- Premium efficiency motors, direct drive systems, and variable speed fan control provide the highest available efficiencies and operating cost savings.
- Electronically commutated motor driven or VFD controlled backward curved plenum fans are available to provide precise airflow control and reduced power consumption.
- Supply fans, exhaust fans, and return fans can be incorporated into fan arrays for redundancy, low turndown, and low noise capabilities.

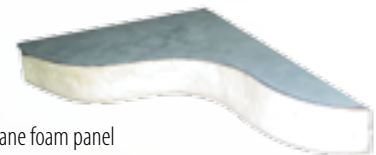

- ▶ Double wall rigid polyurethane foam panel construction increases thermal resistance, reduces air leakage and attenuates radiated noise.

## Features and Options

- AAONAIRE energy recovery is factory installed to reduce the operating expenses associated with supplying outside air to buildings. By reclaiming up to 80% of the exhaust air energy, AAONAIRE energy recovery units maintain comfortable temperatures and humidity during both cooling and heating conditions. AAONAIRE energy recovery wheels are rated to AHRI Standard 1060 and bear the AHRI Certification symbol.
- Pleated and cartridge filters are available with or without monitoring devices to meet the building's required indoor air quality.
- UV-C lighting is available inside the cabinet to meet even the most stringent indoor air quality requirements while increasing system performance and longevity by eliminating mold growth on coils.
- Coils are available with polymer e-coatings, copper fins, and stainless steel casings to minimize corrosion and improve air quality.
- Modulating hot gas reheat can provide the precise humidity control necessary to maintain occupant comfort.
- Cabinets can have custom interior and exterior paint to enhance aesthetics while improving corrosion resistance and indoor air quality.
- Electric and hot water preheat systems can be provided to prevent hydronic coil freezing.



▲ Factory installed indirect fired gas heater provides energy efficient heating.

## Controls

- Unit wiring is completely factory provided with color-coded wires. Units are provided with unit specific, color-coded wiring diagrams. Diagrams are laminated and permanently affixed inside control compartment access door.
- Factory provided or customer provided controller can be selected to meet existing or new building control architecture.
- Factory run test and inspection reports are included in the documentation compartment affixed to the interior of the control compartment access door.

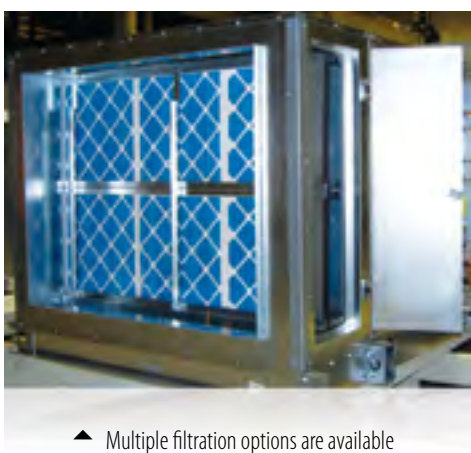

▲ Multiple filtration options are available on the M2 Series.

M2 Model	Nominal cfm	Width (inches)	Height (in) Single Level	Height (in) Dual Level	Length (inches)
005	2,000	50	32	66	Length may vary depending on options selected
008	3,500		44	90	
011	4,500	62	48	98	
014	6,500		54	110	
018	8,000	84	48	98	
022	11,500		54	110	
026	13,500		64	130	
032	16,500		96	70	
036	18,500				

*All dimensions are in inches.*

*Design cfm may be up to 35% greater than nominal cfm.*



**Don't see the specific product you need?** AAON can meet your requirements with Custom Equipment designed specifically for your exact application and job specifications. Visit [www.aaon.com/repsearch](http://www.aaon.com/repsearch) or call 918.583.2266 to locate a representative near you.



# M2 Series

	005	008	011	014	018	022	026	032	036
<b>Cooling Options</b>									
Tonnage	3-5	6-10	11-15	11-15	16-30	16-30	30-50	40-70	50-70
Number of Compressors	1	1	2	2	2	2	2 or 4	4	4
10-100% Variable Capacity Compressor	✓	✓	✓	✓	✓	✓	✓	✓	✓
Coaxial Heat Exchanger	✓								
Brazed Plate Heat Exchanger		✓	✓	✓	✓	✓	✓	✓	✓
High Capacity DX Coil	✓	✓	✓	✓	✓	✓	✓	✓	✓
<b>Heating Options</b>									
Electric Heat	✓	✓	✓	✓	✓	✓	✓	✓	✓
Steam Distributing Coil	✓	✓	✓	✓	✓	✓	✓	✓	✓
Hot Water Coil	✓	✓	✓	✓	✓	✓	✓	✓	✓
Natural Gas	✓	✓	✓	✓	✓	✓	✓	✓	✓
LP Gas	✓	✓	✓	✓	✓	✓	✓	✓	✓
<b>Refrigeration Options</b>									
Modulating Hot Gas Reheat	✓	✓	✓	✓	✓	✓	✓	✓	✓
<b>Unit Air Intake Options</b>									
Economizer	✓	✓	✓	✓	✓	✓	✓	✓	✓
Energy Recovery Wheel - Total or Sensible	✓	✓	✓	✓	✓	✓	✓	✓	✓
100% Outside Air Unit	✓	✓	✓	✓	✓	✓	✓	✓	✓
100% Return Air Unit	✓	✓	✓	✓	✓	✓	✓	✓	✓
<b>Serviceability Options</b>									
Magnehelic Gauge/ Clogged Filter Switch	✓	✓	✓	✓	✓	✓	✓	✓	✓
Convenience Outlet	✓	✓	✓	✓	✓	✓	✓	✓	✓
Shipping Splits	✓	✓	✓	✓	✓	✓	✓	✓	✓
Non-fused Disconnect Switch	✓	✓	✓	✓	✓	✓	✓	✓	✓
Service Lights	✓	✓	✓	✓	✓	✓	✓	✓	✓

## Available Modules

- Fan Module**
- Filter Module**
- Mixing Box Module**
- Heating Module**
- Cooling Module**
- Blank Module**
- Controls Module**
- Energy Recovery Module**
- Water-Source Heat Pump Module**



# M2 Series

	005	008	011	014	018	022	026	032	036
<b>Filter Options</b>									
2" Pleated - 30% Efficient - MERV 10	✓	✓	✓	✓	✓	✓	✓	✓	✓
4" Pleated - 30% Efficient - MERV 10	✓	✓	✓	✓	✓	✓	✓	✓	✓
4" Pleated - 65% Efficient - MERV 11	✓	✓	✓	✓	✓	✓	✓	✓	✓
4" Pleated - 85% Efficient - MERV 13	✓	✓	✓	✓	✓	✓	✓	✓	✓
4" Pleated - 95% Efficient - MERV 14	✓	✓	✓	✓	✓	✓	✓	✓	✓
12" Cartridge - 65% Efficient - MERV 11	✓	✓	✓	✓	✓	✓	✓	✓	✓
12" Cartridge - 85% Efficient - MERV 13	✓	✓	✓	✓	✓	✓	✓	✓	✓
12" Cartridge - 95% Efficient - MERV 14	✓	✓	✓	✓	✓	✓	✓	✓	✓
<b>Safety Options</b>									
Return Air Firestat	✓	✓	✓	✓	✓	✓	✓	✓	✓
Supply Air Firestat	✓	✓	✓	✓	✓	✓	✓	✓	✓
Return Air Smoke Detector	✓	✓	✓	✓	✓	✓	✓	✓	✓
Phase and Brownout Protection	✓	✓	✓	✓	✓	✓	✓	✓	✓
<b>Control Options</b>									
Variable Air Volume (VAV)	✓	✓	✓	✓	✓	✓	✓	✓	✓
Constant Air Volume	✓	✓	✓	✓	✓	✓	✓	✓	✓
Single Zone VAV	✓	✓	✓	✓	✓	✓	✓	✓	✓
Makeup Air	✓	✓	✓	✓	✓	✓	✓	✓	✓
Remote Start/Stop Terminals	✓	✓	✓	✓	✓	✓	✓	✓	✓
Customer Provided Controls - Field Installed	✓	✓	✓	✓	✓	✓	✓	✓	✓
Customer Provided Controls - Factory Installed	✓	✓	✓	✓	✓	✓	✓	✓	✓
<b>Preheat Options</b>									
Steam Distributing Coil	✓	✓	✓	✓	✓	✓	✓	✓	✓
Hot Water Coil	✓	✓	✓	✓	✓	✓	✓	✓	✓
Electric Preheat	✓	✓	✓	✓	✓	✓	✓	✓	✓
<b>Supply Fan Options</b>									
VFD Controlled Backward Curved Plenum Supply Fan	✓	✓	✓	✓	✓	✓	✓	✓	✓
ECM Driven Backward Curved Plenum Supply Fan	✓	✓	✓	✓					
Dual Fan Configuration								✓	✓
<b>Coil Options</b>									
E-Coated	✓	✓	✓	✓	✓	✓	✓	✓	✓
Copper Fins	✓	✓	✓	✓	✓	✓	✓	✓	✓
Stainless Steel Casing	✓	✓	✓	✓	✓	✓	✓	✓	✓
High Pressure Water Coils (400 psi)	✓	✓	✓	✓	✓	✓	✓	✓	✓
UV Lights	✓	✓	✓	✓	✓	✓	✓	✓	✓



AAON **SA SERIES MODULAR SELF-CONTAINED UNITS** LEAD THE INDUSTRY IN SELF-CONTAINED UNIT TECHNOLOGY AND PERFORMANCE. VERTICAL CONFIGURATION, VARIABLE CAPACITY SCROLL COMPRESSORS, DIRECT DRIVE BACKWARD CURVED PLENUM SUPPLY FANS, DOUBLE WALL RIGID POLYURETHANE FOAM INSULATED CABINET CONSTRUCTION, AND OPTIONAL HEAT PUMP CONFIGURATION PROVIDE THE SA SERIES WITH UNMATCHED PERFORMANCE.

## Applications

- Vertical self-contained unit with a water-cooled condenser or to match with a remote air-cooled condenser, from 23 - 70 tons.
- Variable capacity R-410A scroll compressors (10 - 100%) provide load matching cooling and improved part load efficiency.
- Air-source, water-source, or geothermal heat pump configurations.
- Makeup air capability, up to 100% outside air, to meet ventilation requirements.
- High performance hot water or steam heating coils allow unit to tie into a boiler system.

▶ SA Series Single Cabinet Unit



▲ SA Series Dual Cabinet Unit

## Construction

- Two-inch double wall rigid polyurethane foam panel cabinet construction has a thermal resistance of R-13 or greater, which exceeds the R-value of a cabinet with four-inch thick fiberglass construction. Panels include a thermal break, with no metal contact from inside to outside, to prevent heat transfer through the panel and prevent condensation on the outside of the cabinet. The inner wall protects the insulation from moisture damage, prevents microbial growth, and is easy to clean. This type of construction also makes the cabinet more rigid and resistant to damage, provides increased sound dampening, and reduces air leakage and infiltration.
- Modular design with compact footprint makes the SA Series ideal for retrofit applications.
- Access doors with full length stainless steel piano hinges and quarter turn, zinc cast, lockable handles provide improved reliability over single point hinges and plastic or sheet metal handles, and make the unit easily serviceable.
- Corrosion resistant exterior polyurethane paint exceeds a 2,500 hour salt spray test.
- Double sloped stainless steel drain pans eliminate standing water which can support microbial growth and stainless steel construction prevents corrosion that could lead to water leaks and contaminants in the air stream.



### Don't see the specific product you need?

AAON can meet your requirements with Custom Equipment designed specifically for your exact application and job specifications. Visit [www.aaon.com/repsearch](http://www.aaon.com/repsearch) or call 918.583.2266 to locate a representative near you.

## Fans and Blowers

- Spring isolated direct drive backward curved plenum fans are more energy efficient, quieter, and require less maintenance than belt driven fans. These single thickness airfoil plenum blowers are quieter and more energy efficient than forward curved blowers.
- Single or multiple supply air connections can be factory provided from the right, left, back, or top sides of the supply fan plenum.
- VFD controlled supply fans allow precise airflow control and reduced power consumption.

- Multiple high efficiency filtration options, with up to a MERV 14 efficiency rating.
- Polymer e-coated coils are available to extend the life of the coils and protect them in corrosive environments.
- Interior corrosion protection option protects interior components of the unit in corrosive environments.

## Controls

- Labeled electrical components and color-coded wiring match the unit specific color-coded wiring diagram which is laminated and permanently affixed inside the control compartment.
- Factory provided or customer provided controller can be selected to meet existing or new building control architecture.
- Unit controls are contained within single compartment isolated from the air stream for ease of service and quiet operation.
- Factory run test report, wiring diagram, and Installation, Operation, and Maintenance manual with startup form are provided in the control compartment of every unit.

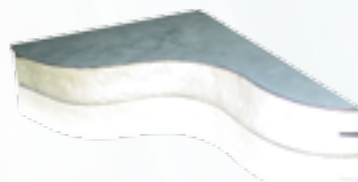

▲ Rigid polyurethane foam panel construction provides increased sound dampening and reduces air leakage and infiltration.



◀ SA Series single cabinet self-contained unit with factory installed waterside economizer coil allows free cooling at low ambient conditions.

## Features and Options

- Factory installed constant or variable flow waterside economizer allows for free cooling at low ambient conditions.
- Multiple methods of humidity control including: high capacity cooling coils and modulating humidity control which provides energy efficient dehumidification, even with low sensible heat loads, without the temperature swings common with on/off reheat systems.

SA Model	Intake	Nominal cfm	Width*	Height*	Length
023	Single	6,900	55	111-135 (in 4 inch increments)	79
028		8,400			
030		9,000			
035		10,500			
045	Double	13,500	110**		
050		15,000			
055		16,500			
058		17,400			
060		18,000			
065		19,500			
070		21,000			

\*Dimensions may vary depending on options selected.

\*\*Double intake units can be split in half for ease of installation.

All dimensions are in inches.

Design cfm may be 30-50% greater or less than nominal cfm.





# SA Series

	023	028	030	035	045	050	055	058	060	065	070
<b>Cooling Options</b>											
Number of Compressors/Circuits	2/2	2/2	2/2	2/2	4/4	4/4	4/4	4/4	4/4	4/4	4/4
10-100% Variable Capacity Compressor	✓	✓	✓	✓	✓	✓	✓	✓	✓	✓	✓
High Capacity DX Coil	✓	✓	✓	✓	✓	✓	✓	✓	✓	✓	✓
Waterside Economizer	✓	✓	✓	✓	✓	✓	✓	✓	✓	✓	✓
Shell and Tube Water-to-Refrigerant Heat Exchanger	✓	✓	✓	✓	✓	✓	✓	✓	✓	✓	✓
Braze Plate Water-to-Refrigerant Heat Exchanger	✓	✓	✓	✓	✓	✓	✓	✓	✓	✓	✓
SMO 254 Corrosion Resistant Brazed Plate	✓	✓	✓	✓	✓	✓	✓	✓	✓	✓	✓
Remote Condenser Configuration	✓	✓	✓	✓	✓	✓	✓	✓	✓	✓	✓
<b>Heating Options</b>											
Water-Source/Geothermal Heat Pump	✓	✓	✓	✓	✓	✓	✓	✓	✓	✓	✓
<b>Refrigeration Options</b>											
Modulating Hot Gas Reheat	✓	✓	✓	✓	✓	✓	✓	✓	✓	✓	✓
Modulating Head Pressure Control	✓	✓	✓	✓	✓	✓	✓	✓	✓	✓	✓
<b>Unit Air Intake Options</b>											
100% Outside Air Unit	✓	✓	✓	✓	✓	✓	✓	✓	✓	✓	✓
100% Return Air Unit	✓	✓	✓	✓	✓	✓	✓	✓	✓	✓	✓
<b>Serviceability Options</b>											
Magnehelic Gauge	✓	✓	✓	✓	✓	✓	✓	✓	✓	✓	✓
Clogged Filter Switch	✓	✓	✓	✓	✓	✓	✓	✓	✓	✓	✓
Sight Glass	✓	✓	✓	✓	✓	✓	✓	✓	✓	✓	✓
Compressor Isolation Valves	✓	✓	✓	✓	✓	✓	✓	✓	✓	✓	✓
Motorized Shut-Off Valve	✓	✓	✓	✓	✓	✓	✓	✓	✓	✓	✓
<b>Filter Options</b>											
2" Pleated - 30% Efficient - MERV 8	✓	✓	✓	✓	✓	✓	✓	✓	✓	✓	✓
4" Pleated - 30% Efficient - MERV 8	✓	✓	✓	✓	✓	✓	✓	✓	✓	✓	✓
4" Pleated - 65% Efficient - MERV 11	✓	✓	✓	✓	✓	✓	✓	✓	✓	✓	✓
4" Pleated - 85% Efficient - MERV 13	✓	✓	✓	✓	✓	✓	✓	✓	✓	✓	✓
4" Pleated - 95% Efficient - MERV 14	✓	✓	✓	✓	✓	✓	✓	✓	✓	✓	✓



# SA Series

	023	028	030	035	045	050	055	058	060	065	070
<b>Safety Options</b>											
Supply Air Smoke Detector	✓	✓	✓	✓	✓	✓	✓	✓	✓	✓	✓
UV Lights	✓	✓	✓	✓	✓	✓	✓	✓	✓	✓	✓
Phase and Brownout Protection	✓	✓	✓	✓	✓	✓	✓	✓	✓	✓	✓
Drain Pan Overflow Switch	✓	✓	✓	✓	✓	✓	✓	✓	✓	✓	✓
Freeze Stat	✓	✓	✓	✓	✓	✓	✓	✓	✓	✓	✓
<b>Control Options</b>											
Variable Air Volume (VAV)	✓	✓	✓	✓	✓	✓	✓	✓	✓	✓	✓
Constant Air Volume	✓	✓	✓	✓	✓	✓	✓	✓	✓	✓	✓
Single Zone VAV	✓	✓	✓	✓	✓	✓	✓	✓	✓	✓	✓
Makeup Air Unit	✓	✓	✓	✓	✓	✓	✓	✓	✓	✓	✓
Customer Provided - Field Installed	✓	✓	✓	✓	✓	✓	✓	✓	✓	✓	✓
Customer Provided - Factory Installed	✓	✓	✓	✓	✓	✓	✓	✓	✓	✓	✓
<b>Preheat Options</b>											
Steam Distributing Coil	✓	✓	✓	✓	✓	✓	✓	✓	✓	✓	✓
Hot Water Coil	✓	✓	✓	✓	✓	✓	✓	✓	✓	✓	✓
<b>Supply Fan Options</b>											
VFD Controlled Supply Fan	✓	✓	✓	✓	✓	✓	✓	✓	✓	✓	✓
Multiple Fan Configuration	✓	✓	✓	✓	✓	✓	✓	✓	✓	✓	✓
Spring Vibration Isolation	✓	✓	✓	✓	✓	✓	✓	✓	✓	✓	✓
<b>Construction Options</b>											
Multiple Plenum Heights with or without Sound Attenuation	✓	✓	✓	✓	✓	✓	✓	✓	✓	✓	✓
Shipping Splits	✓	✓	✓	✓	✓	✓	✓	✓	✓	✓	✓
Forkliftable Base	✓	✓	✓	✓	✓	✓	✓	✓	✓	✓	✓
<b>Code Options</b>											
Chicago Code	✓	✓	✓	✓	✓	✓	✓	✓	✓	✓	✓



AAON **SB SERIES SELF-CONTAINED UNITS** ARE ENGINEERED FOR HIGH PERFORMANCE AND ENERGY EFFICIENT FULL AND PART LOAD OPERATION. VARIABLE CAPACITY SCROLL COMPRESSORS, VARIABLE SPEED DIRECT DRIVE BACKWARD CURVED PLENUM SUPPLY FANS, DOUBLE WALL RIGID POLYURETHANE FOAM INSULATED CABINET CONSTRUCTION, AND HEAT PUMP CONFIGURATION PROVIDE THE SB SERIES WITH UNMATCHED PERFORMANCE.

## Applications

- Water-source and geothermal heat pump vertical self-contained unit, from 3-18 tons.
- Split configuration with refrigerant-to-water heat exchanger and compressor compartment shipped separate from the air tunnel section for retrofit or space limited applications.
- Remote air-cooled condenser and air-source heat pump configurations.
- 10-100% variable capacity R-410A scroll compressors provide load matching cooling and heat pump heating and improved part load efficiency.
- Makeup air capability, up to 100% outside air, to meet ventilation requirements.
- Factory installed high performance electric, hot water, or steam heating.



- ▲ Insulated Coaxial Refrigerant-to-Water Heat Exchanger provides energy efficient heat transfer.

## Construction

- Double wall rigid polyurethane foam injected panel cabinet construction has a higher thermal resistance, or R-value, compared with fiberglass construction. Panels include a thermal break, with no metal contact from inside to outside, to prevent heat transfer through the panel and prevent condensation on the outside of the cabinet. Construction also makes the cabinet more rigid and resistant to damage, provides increased sound dampening, and reduces air leakage and infiltration.
- Access doors with chrome plated steel hinges and quarter turn, lockable handles make the unit easily serviceable.
- Double sloped stainless steel drain pans eliminate standing water which can support microbial growth and stainless steel construction prevents corrosion that could lead to water leaks and contaminants in the air stream.
- Coaxial refrigerant-to-water heat exchanger provides energy efficient heat transfer.

SB Model	Cabinet	cfm	Width	Height*	Length*
003	B	1,000-2,000	30	53	65
004					
005					
006	C**	1,800-4,000	42	72	
007					
009					
010					
014	D**	3,000-6,000	56	73	69
016					
018					

\*Dimension may vary depending on options selected

All dimensions are in inches

\*\*C and D cabinet units can be shipped in a split configuration for ease of installation.

## Fans and Blowers

- Direct drive backward curved plenum fans are more energy efficient, quieter, and require less maintenance than belt driven fans. These single thickness airfoil plenum blowers are quieter and more energy efficient than forward curved blowers.
- Electronically commutated motor (ECM) provides precise airflow control and reduced power consumption.

## Controls

- Labeled electrical components and color-coded wiring match the unit specific color-coded wiring diagram which is laminated and permanently affixed inside the control compartment.
- Factory provided or customer provided controller can be selected to meet existing or new building control architecture.
- Unit controls are contained within a compartment isolated from the air stream for ease of service and quiet operation.
- Factory run test report, wiring diagram, and Installation, Operation, and Maintenance manual with startup form are provided in the control compartment of every unit.
- VAV and Single Zone VAV configurations to minimize operating costs.

## Ease of Installation

- Self-contained units are designed to fit through 36 inch wide by 80 inch tall doors for ease of installation and retrofit applications. C and D cabinet units may be shipped from the factory in a split configuration.
- The SB Series cabinet design provides easy installation at the job site. The air tunnel and compressorized section can be factory assembled to prevent unnecessary work at the job site or they can be shipped separate in two sections.

## AAONAIRE Energy Recovery Wheels

AAONAIRE energy recovery wheels, total or sensible, provide energy savings by recycling energy instead of losing energy through the exhaust air stream. AAONAIRE systems also enhance indoor air quality by allowing larger amounts of outside air to be provided to the space with improved humidity control

Factory installed AAONAIRE® energy recovery wheel saves heating and cooling energy. ▶

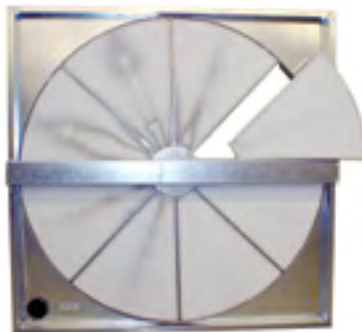

## Features and Options

- Modulating humidity control provides energy efficient dehumidification, even with low sensible heat loads, without the temperature swings common with on/off reheat systems.
- Multiple high efficiency filtration options, with up to a MERV 14 efficiency rating.
- SCR (Silicon Controlled Rectifier) electric heat control for reduced power consumption, longer heater life and improved occupant comfort.
- Polymer e-coated coils, copper finned coils, and stainless steel coil casings are available to extend the life of the coils and protect them in corrosive environments.
- Interior and exterior corrosion protection is available to protect the cabinet in corrosive environments.
- Factory installed mixing boxes with gear driven outside air and return air dampers allow for airside economizer free cooling.
- Factory installed constant or variable flow waterside economizer allows for free cooling at low ambient conditions.



▶ SB Series self-contained units are easily serviceable.





# SB Series

	<b>B Cabinet</b> (3-5 tons)	<b>C Cabinet</b> (6-10 tons)	<b>D Cabinet</b> (14-18 tons)
<b>Cooling Options</b>			
Number of Compressors	1	1	1
10-100% Variable Capacity Compressor	✓	✓	✓
High Capacity DX Coil	✓	✓	✓
Waterside Economizer	✓	✓	✓
CuNi Corrosion Resistant Coaxial Water-to-Refrigerant Heat Exchanger	✓	✓	✓
<b>Heating Options</b>			
Electric Heat	✓	✓	✓
Steam Distributing Coil	✓	✓	✓
Hot Water Coil	✓	✓	✓
Water-Source/Geothermal Heat Pump	✓	✓	✓
<b>Refrigeration Options</b>			
Modulating Hot Gas Reheat	✓	✓	✓
Modulating Head Pressure Control	✓	✓	✓
<b>Unit Air Intake Options</b>			
Economizer	✓	✓	✓
100% Outside Air Unit	✓	✓	✓
100% Return Air Unit	✓	✓	✓
Energy Recovery Wheel - Total or Sensible	✓	✓	✓
<b>Serviceability Options</b>			
Magnehelic Gauge	✓	✓	✓
Clogged Filter Switch	✓	✓	✓
Lockable Door Handles	✓	✓	✓
Removable Pin Hinges	✓	✓	✓
Sight Glass	✓	✓	✓
Compressor Isolation Valves	✓	✓	✓
<b>Filter Options</b>			
2" Pleated - 30% Efficient - MERV 8	✓	✓	✓
4" Pleated - 30% Efficient - MERV 8	✓	✓	✓
4" Pleated - 65% Efficient - MERV 11	✓	✓	✓
4" Pleated - 85% Efficient - MERV 13	✓	✓	✓
4" Pleated - 95% Efficient - MERV 14	✓	✓	✓



# SB Series

	<b>B Cabinet</b> (3-5 tons)	<b>C Cabinet</b> (6-10 tons)	<b>D Cabinet</b> (14-18 tons)
<b>Safety Options</b>			
Return Air Smoke Detector	✓	✓	✓
Freeze Stat	✓	✓	✓
Phase and Brownout Protection	✓	✓	✓
Drain Pan Overflow Switch	✓	✓	✓
<b>Control Options</b>			
Variable Air Volume (VAV)	✓	✓	✓
Constant Air Volume	✓	✓	✓
Single Zone VAV	✓	✓	✓
Makeup Air Unit	✓	✓	✓
Remote Start/Stop Terminals	✓	✓	✓
Customer Provided - Field Installed	✓	✓	✓
Customer Provided - Factory Installed	✓	✓	✓
<b>Preheat Options</b>			
Steam Distributing Coil	✓	✓	✓
Hot Water Coil	✓	✓	✓
Electric Preheat	✓	✓	✓
<b>Construction Options</b>			
Forkliftable Base	✓	✓	✓
Shipping Splits	✓	✓	✓
<b>Supply Fan Options</b>			
ECM Driven Backward Curved Plenum Supply Fan	✓	✓	✓
Dual Fan Configuration			✓



AAON **WH/WV SERIES WATER-SOURCE HEAT PUMP UNITS** ARE OFFERED IN HORIZONTAL AND VERTICAL CONFIGURATIONS WITH A STANDARD LEVEL EFFICIENCY THAT SIGNIFICANTLY EXCEEDS THE ASHRAE STANDARDS. AAON HAS OVER 15 YEARS OF EXPERIENCE MANUFACTURING MASS CUSTOMIZED WATER-SOURCE HEAT PUMPS WITH THE ABILITY TO CONFIGURE THE FEATURES AND OPTIONS OF THE UNIT AT THE FACTORY TO MEET NEARLY ANY APPLICATION'S REQUIREMENTS. AAON HAS RECOGNIZED THE NEED FOR A COMPETITIVELY PRICED, INNOVATIVE, PREMIUM QUALITY WATER-SOURCE HEAT PUMP THAT CAN BE QUICKLY PRODUCED. THE AAON WATER-SOURCE HEAT PUMP TECHNOLOGICALLY ADVANCED PRODUCT LINE IS UNMATCHED IN THE INDUSTRY, UTILIZING A UNIQUE PRODUCTION METHODOLOGY THAT INTEGRATES MASS PRODUCTION WITH MASS CUSTOMIZATION THAT ALLOWS PRODUCTION OF UP TO 180 UNITS PER DAY.

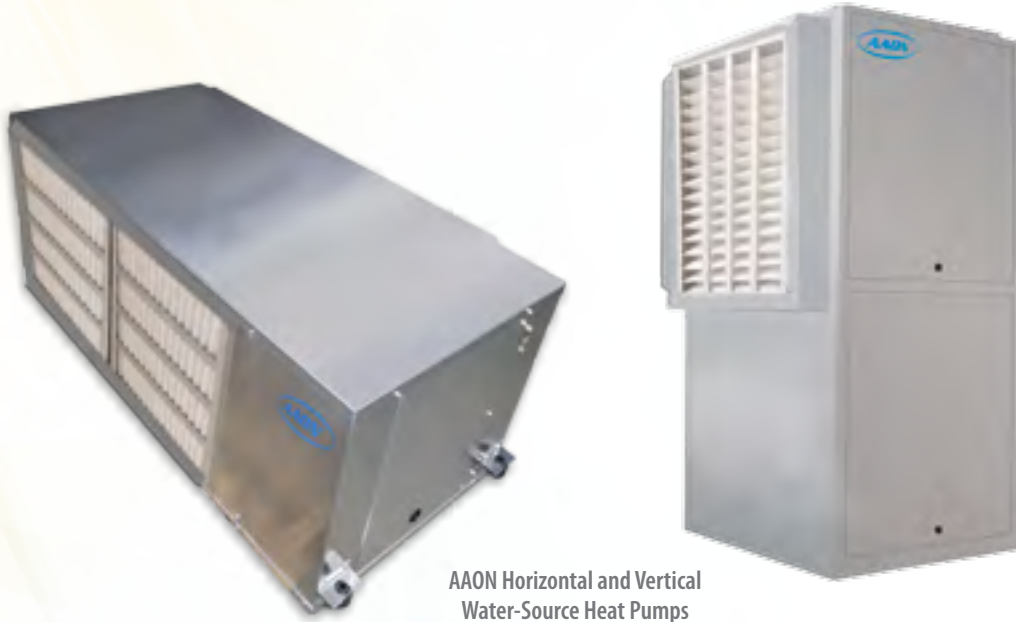

AAON Horizontal and Vertical Water-Source Heat Pumps

### All Aluminum Construction

AAON Water-Source Heat Pumps feature all aluminum cabinet construction with a unit weight that is significantly less than a conventional water-source heat pump galvanized steel unit. Additional construction features include hem bends on all exposed edges, integrated hanging brackets and a filter rack that is integrated into the unit cabinet.

### AAON Metal Pallet

AAON designed a custom sheet metal pallet for the AAON Water-Source Heat Pump. The pallet allows multiple units to be stacked and is used to ship and store the units. It will not be damaged during transit or storage as is common with wood pallets used with conventional water-source heat pump units. Once the equipment is installed at the jobsite the metal pallet can be easily sold or recycled!

### Microchannel Coils

AAON Water-Source Heat Pumps feature an aluminum microchannel indoor DX coil with a larger surface area than conventional water-source heat pumps. Microchannel coils improve the efficiency of the unit, reduce air pressure drop, reduce fan horsepower, and reduce unit weight.

### Replacement Ready

AAON Water-Source Heat Pumps are stocked and ready to ship. Replacement units match the size of conventional water-source heat pump units.

## AAON Water-Source Heat Pump Features:

- ½ to 15 ton Capacities
- Horizontal and Vertical Configurations
- Left or Right Return
- Left, Right, or End Discharge
- High Efficiency PSC or ECM Supply Fan Motor
- Multiple Levels of Efficiency
- Standard Level Efficiency Significantly Exceeds ASHRAE Standards
- High Efficiency Scroll or Rotary Compressors
- Complete and Easy Service Access to the Supply Fan, Compressor, Reversing Valve, Expansion Valve, Controls, and Filters
- Bottom Access to Expansion Valve, Reversing Valve, Filter Drier, Supply Fan, and Filters
- Factory installed options including disconnect, high efficiency filtration, hot gas reheat dehumidification, and waterside economizer.

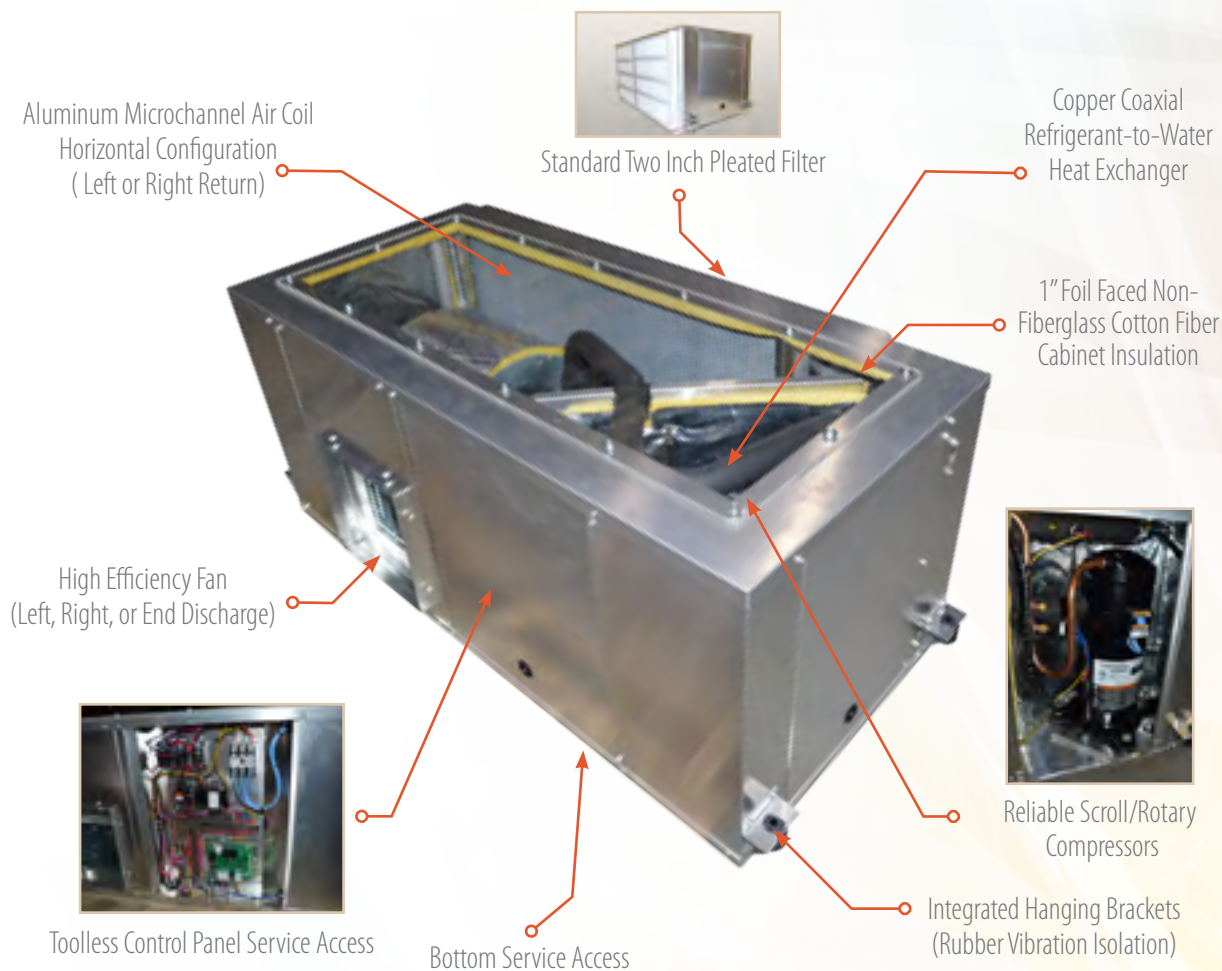

# AAON QUICK SELECTION

**Airflow (cfm)**

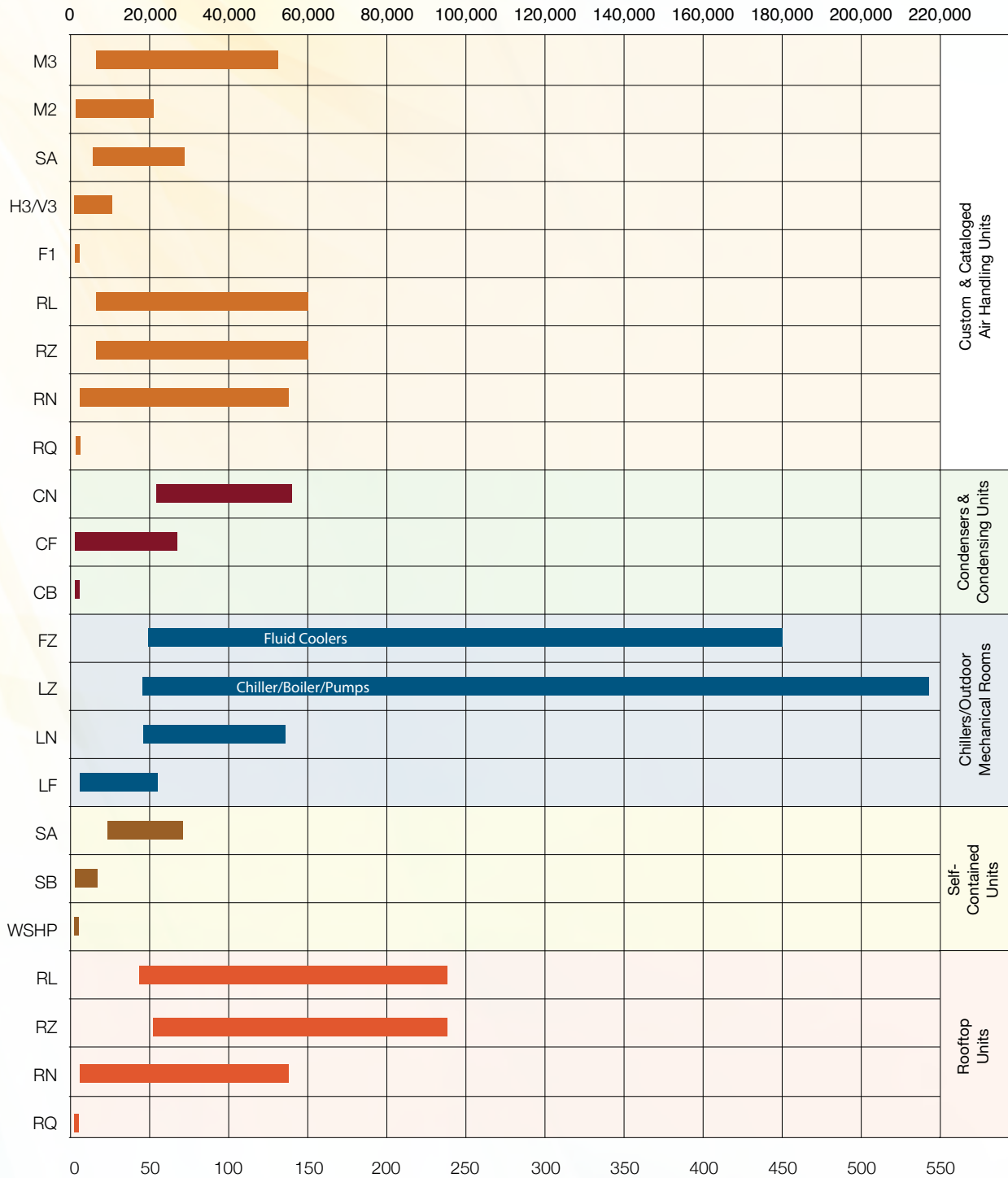

**Nominal Cooling (tons)**



**Don't see the specific product you need?** AAON can meet your requirements with Custom Equipment designed specifically for your exact application and job specifications. Visit [www.aaon.com/repsearch](http://www.aaon.com/repsearch) or call 918.583.2266 to locate a representative near you.



# ROOFTOP UNITS

(Air-Cooled, Water-Cooled, Evaporative-Cooled, & Heat Pumps)



AAON **RL SERIES ROOFTOP UNITS** SET THE STANDARD FOR LARGE COMMERCIAL PACKAGED ROOFTOP UNITS IN CUSTOMIZATION, PERFORMANCE, AND SERVICEABILITY. DOUBLE WALL RIGID POLYURETHANE FOAM INSULATED CABINET CONSTRUCTION AND AN ARRAY OF DRAW-THROUGH OR BLOW-THROUGH DIRECT DRIVE BACKWARD CURVED PLENUM FANS ALLOW RL SERIES UNITS TO HAVE QUIET, ENERGY EFFICIENT AIRFLOW WITH HIGH STATIC PRESSURE CAPABILITIES.

### Applications

- Air-cooled, water-cooled, or evaporative-cooled condenser packaged DX rooftop unit, from 45 - 240 tons.
- Air-source, water-source, or geothermal heat pump configurations.
- Makeup air capability, up to 100% outside air, to meet ventilation requirements.
- High performance hot water, steam, electric and indirect/direct gas fired heating.
- Turbocor magnetic bearing R-134a centrifugal compressor option provides load matching cooling capabilities, with quiet energy efficient operation, and the oil free design is highly reliable.
- Variable speed R-410A scroll compressors for load matching cooling and improved part load efficiency.

### Construction

- Two-inch double wall rigid polyurethane foam panel cabinet construction has a thermal resistance of R-13 or greater, which exceeds the R-value of a cabinet with four-inch thick fiberglass construction. Panels include a thermal break, with no metal contact from inside to outside, to prevent heat transfer through the panel and prevent condensation on the outside of the cabinet. The inner wall protects the insulation from moisture damage, prevents microbial growth, and is easy to clean. This type of construction also makes the cabinet more rigid and resistant to damage, provides increased sound dampening, and reduces air leakage and infiltration.
- Access doors with full length stainless steel piano hinges and quarter turn, zinc cast, lockable handles provide improved reliability over single point hinges and plastic or sheet metal handles, and make the unit easily serviceable.
- Aluminum tread plate flooring is included in equipment access areas for improved durability and safety.
- Corrosion resistant exterior polyurethane paint exceeds a 2,500 hour salt spray test.



▲ RL Series Evaporative-Cooled Condenser Rooftop Unit

- Double sloped stainless steel drain pans eliminate standing water which can support microbial growth and stainless steel construction prevents corrosion that could lead to water leaks and contaminants in the air stream.

### Fans and Blowers

- Spring isolated direct drive backward curved plenum fans are more energy efficient, quieter, and require less maintenance than belt driven fans. These single thickness airfoil plenum blowers are quieter and more energy efficient than forward curved blowers.
- Selectable number of draw-through or blow-through direct drive backward curved plenum fans allows design flexibility for quieter applications and applications where unit uptime is critical.
- VFD controlled supply, exhaust, and return fans for precise airflow control, building pressure control, and reduced power consumption.
- Axial flow and plenum style return blowers are available to meet a variety of state applications.



▲ Fan arrays provide quiet and efficient airflow through multiple fans.

## Controls

- Labeled electrical components and color-coded wiring match the unit specific color-coded wiring diagram which is laminated and permanently affixed inside the control compartment.
- Factory provided or customer provided controller can be selected to meet existing or new building control architecture.
- Unit controls are contained within a walk-in service compartment isolated from the air stream for ease of service and quiet operation. Service compartment can be independently heated.
- Run test report, color-coded wiring diagram, and Installation, Operation and Maintenance manual with startup form is included in control access compartment of every unit.



▲ Corrosion resistant exterior polyurethane paint exceeds a 2,500 hour salt spray test.

## Features and Options

- Turbocor magnetic bearing R-134a centrifugal compressor option provides load matching cooling capabilities, with quiet energy efficient operation, and the oil free design is highly reliable.
- Variable speed R-410A scroll compressors for load matching cooling and improved part load efficiency. Multiple methods of humidity control including: High Capacity Cooling Coils, Return Air Bypass, and Modulating Humidity Control which provides energy efficient dehumidification, even with low sensible heat loads, without the temperature swings common with on/off reheat systems.
- Factory installed AAON evaporative-cooled condenser, with air-cooled de-superheater and variable frequency drive controlled fans, can be 20-40% more energy efficient than a comparable air-cooled condenser, can use 22-100% less water than a conventional evaporative-cooled condenser, and require 22-100% less chemical usage than a conventional evaporative-cooled condenser.
- Interior of evaporative-cooled condenser is constructed of 304 stainless steel and other non-corrosive materials. De-superheater coils include polymer e-coating for corrosion protection.
- Factory installed, microprocessor controlled, three chemical, water treatment system is standard with an evaporative-cooled condenser saving installation and maintenance time and money.
- Factory installed shell and tube water-cooled condensers include removable and cleanable basket filters and can be factory piped to require only a single water connection at the unit.
- High efficiency, multiple stage, gas and electric heating are available to meet job requirements.
- Factory installed, sensible or enthalpy, gear driven economizer allows for free cooling.
- Multiple high efficiency filtration options, including pleated, cartridge, or bag type, with up to a MERV 14 efficiency rating.
- Factory installed total and sensible AAONAIR® energy recovery wheels save cooling and heating dollars. Return fans are available for high return static applications.
- Polymer e-coated coils are available to extend the life of the coils and protect them in corrosive environments.
- Interior corrosion protection option protects interior components of the unit in corrosive environments.

▼ RL Series Air-Cooled Condenser Rooftop Unit





Patented de-superheater design reduces water consumption and chemical treatment

### 75 ton Evaporative-Cooled Condenser Rooftop Unit

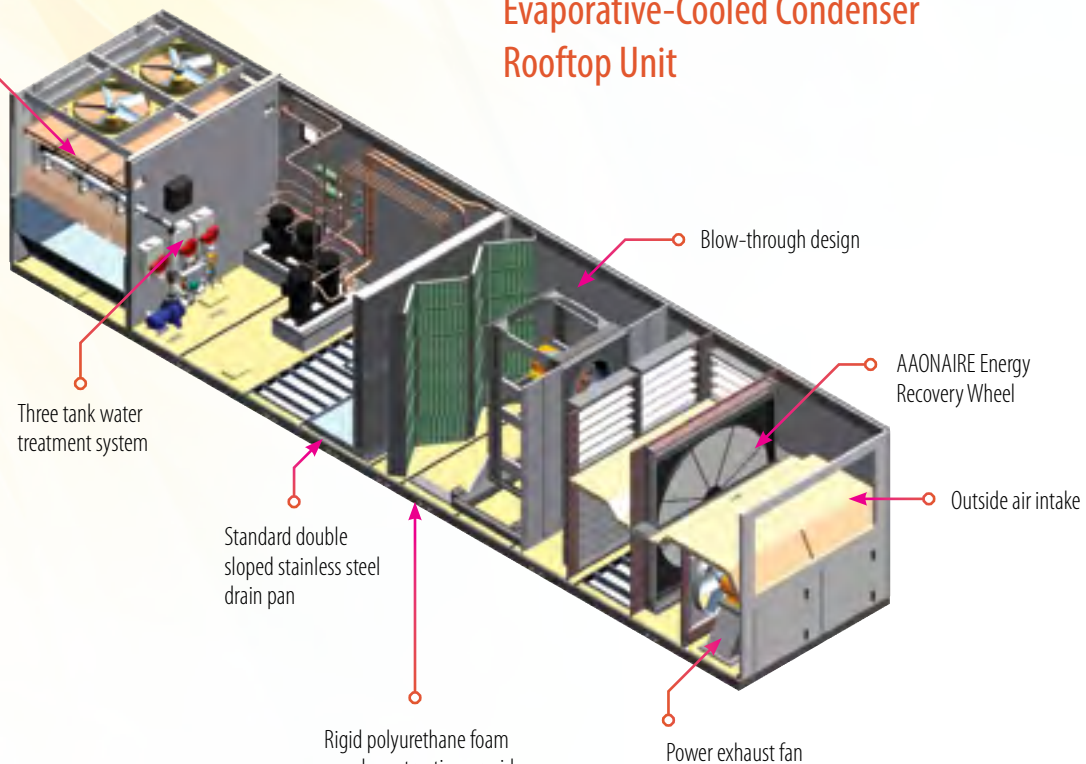

Rigid polyurethane foam panel construction provides greater thermal efficiency and improved indoor air quality

Sloped condenser coils with outer coil protection

### 75 ton Air-Cooled Condenser Rooftop Unit

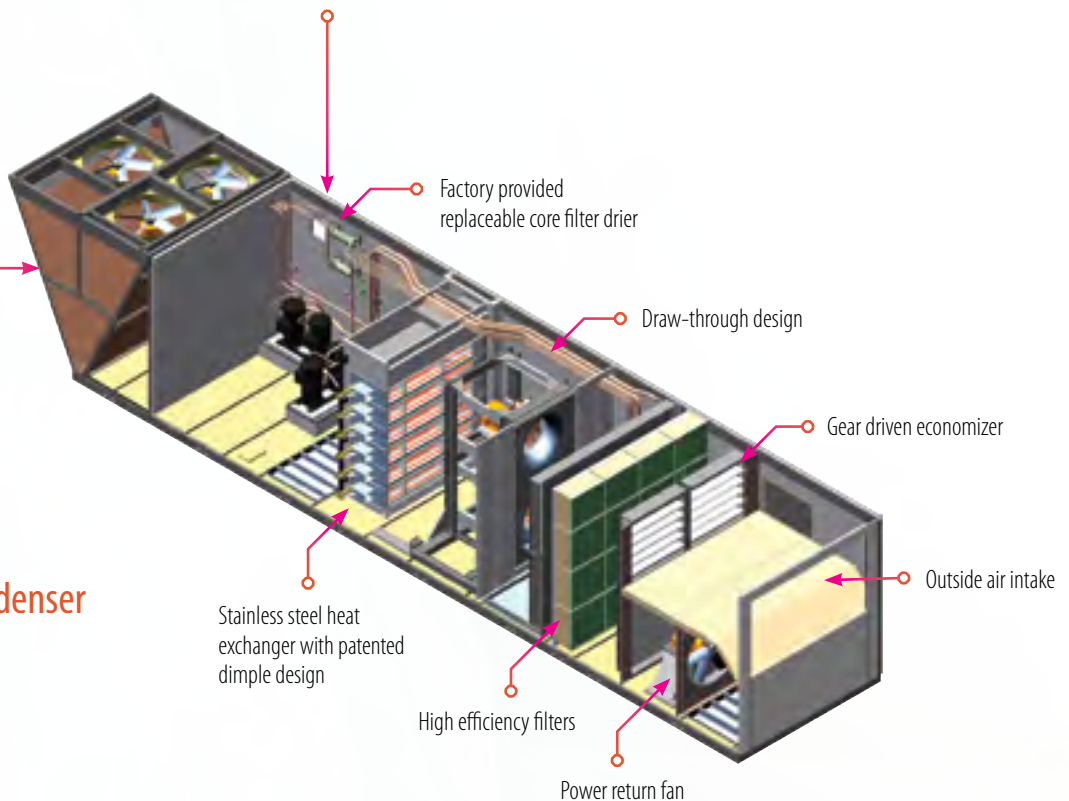



## 135 ton Water-Cooled Condenser Rooftop Unit

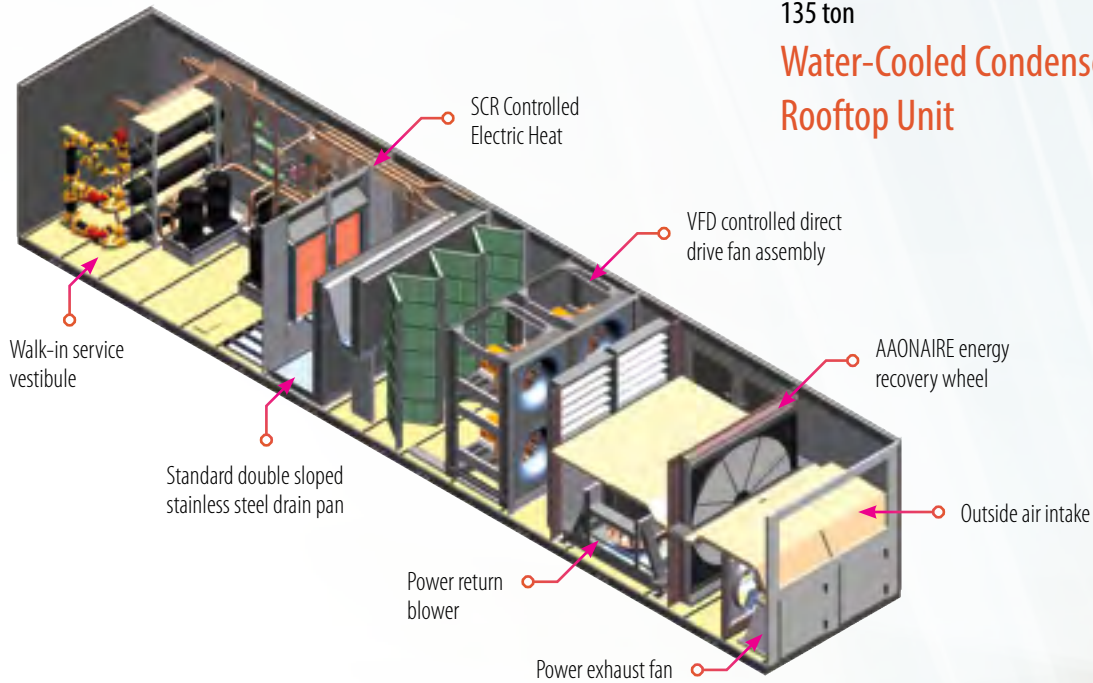

RL Model	Nominal cfm	Width	Height	Length*
045	15,000	100	102	400
060	18,000			
070	20,000			
075	21,000			
090	22,000			
095	22,000			508
100	26,000			
110	26,000			
120	27,500			
125	28,500			
134	33,000	142	102	506
135	30,000	100		508
150	35,000	142		506
155	36,000			
170	38,500			
180	43,000			
181	43,000			
190	43,000			
210	45,000			
230	47,000			
240	48,000			



▲ Factory installed AAONAIRE® energy recovery wheel saves heating and cooling energy.

\*Dimension may vary depending on options selected.  
All dimensions are in inches.  
Design cfm may be 30-50% greater or less than nominal cfm.



# RL Series

	R-410A Scroll Compressor Units (45-230 tons)	R-134a Turbocor Centrifugal Compressor Units (90-240 tons)
<b>Cooling Options</b>		
Blow-Through or Draw-Through Fan Configuration	✓	✓
Variable Capacity Compressors	✓	✓
Evaporative-Cooled Condenser	✓	✓
Air-Cooled Condenser	✓	
Water-Cooled Condenser	✓	
Air Handling Unit - No Cooling	✓	
Air Handling Unit - DX Coil	✓	
Air Handling Unit - Chilled Water Coil	✓	
<b>Heating Options</b>		
Electric Heat	✓	✓
Natural Gas	✓	✓
Natural Gas Modulating	✓	✓
Steam Distributing Coil	✓	✓
Hot Water Coil	✓	✓
Air-Source Heat Pump	✓	
Water-Source/Geothermal Heat Pump	✓	
<b>Unit Air Intake Options</b>		
Economizer	✓	✓
Energy Recovery Wheel - Total or Sensible	✓	✓
100% Outside Air Unit	✓	✓
<b>Serviceability Options</b>		
Factory Wired Convenience Outlet	✓	✓
Compression Isolation Valves	✓	✓
Replaceable Core Filter Dryers	Standard	Standard
Service Lights	✓	✓
<b>Filter Options</b>		
2" Pleated - 30% Efficient - MERV 8	✓	✓
4" Pleated - 30% Efficient - MERV 8	✓	✓
2" Permanent Filter Frame	✓	✓
12" Cartridge - 65% Efficient - MERV 11	✓	✓
12" Cartridge - 85% Efficient - MERV 13	✓	✓
12" Cartridge - 95% Efficient - MERV 14	✓	✓
30" Bag - 85% Efficient - MERV 13	✓	✓
30" Bag - 95% Efficient - MERV 14	✓	✓

# RL Series

	R-410A Scroll Compressor Units (45-230 tons)	R-134a Turbocor Centrifugal Compressor Units (90-240 tons)
<b>Refrigeration Options</b>		
Modulating Hot Gas Reheat	✓	✓
Sight Glass	✓	✓
VFD Controlled Condenser Fans with Head Pressure Control	✓	✓
0°F Low Ambient Flooded Condenser	✓	
<b>VFD Controlled Fan Options</b>		
Supply Fans	✓	✓
Power Exhaust Fans	✓	✓
Power Return Fans	✓	✓
<b>Safety Options</b>		
Return Air Firestat	✓	✓
Supply Air Firestat	✓	✓
Supply Air Smoke Detector	✓	✓
Return Air Smoke Detector	✓	✓
<b>Control Options</b>		
Variable Air Volume (VAV)	✓	✓
Constant Air Volume	✓	✓
Single Zone VAV	✓	✓
Makeup Air Unit	✓	✓
Remote Start/Stop Terminals	✓	✓
Customer Provided Controller - Field Installed	✓	✓
Customer Provided Controller - Factory Installed	✓	✓
<b>Preheat Options</b>		
Steam Distributing Coil	✓	✓
Hot Water Coil	✓	✓
<b>Construction Options</b>		
Base Insulation	Standard	Standard
Burglar Bars	✓	✓
Access Door Windows	✓	✓
Fan Sound Attenuation	✓	✓
Single or Two Piece Unit	✓	✓
<b>Code Options</b>		
Chicago Code	✓	✓



AAON **RZ SERIES ROOFTOP UNITS** SET THE STANDARD FOR LARGE COMMERCIAL OUTDOOR SELF-CONTAINED UNITS IN CUSTOMIZATION, PERFORMANCE, AND SERVICEABILITY. DOUBLE WALL RIGID POLYURETHANE FOAM INSULATED CABINET CONSTRUCTION AND AN ARRAY OF DRAW-THROUGH OR BLOW-THROUGH DIRECT DRIVE BACKWARD CURVED PLENUM FANS ALLOW RZ SERIES UNITS TO HAVE QUIET, ENERGY EFFICIENT AIRFLOW WITH HIGH STATIC PRESSURE CAPABILITIES.

### Applications

- Packaged rooftop unit with an air-cooled, water-cooled, or evaporative-cooled condenser, from 55–240 tons.
- Chilled water or non-compressorized DX air handling unit, from 8,900 – 75,500 cfm.
- Available as a water-source, or geothermal heat pump.
- Makeup air capability, up to 100% outside air, to meet ventilation requirements.
- High performance hot water, steam, electric and indirect/direct fired gas heating.
- Turbocor magnetic bearing R-134a centrifugal compressor option provides load matching cooling capabilities, with quiet energy efficient operation, and the oil free design is highly reliable.
- Variable speed R-410A scroll compressors for load matching cooling and improved part load efficiency.

### Construction

- Two-inch double wall rigid polyurethane foam panel cabinet construction has a thermal resistance of R-13 or greater, which exceeds the R-value of a cabinet with four-inch thick fiberglass construction. Panels include a thermal break, with no metal contact from inside to outside, to prevent heat transfer through the panel and prevent condensation on the outside of the cabinet. The inner wall protects the insulation from moisture damage, prevents microbial growth, and is easy to clean. This type of construction also makes the cabinet more rigid and resistant to damage, provides increased sound dampening, and reduces air leakage and infiltration.
- Access doors with full length stainless steel piano hinges and quarter turn, zinc cast, lockable handles provide improved reliability over single point hinges and plastic or sheet metal handles, and make the unit easily serviceable.
- Aluminum tread plate flooring is included in equipment access areas for improved durability and safety.
- Corrosion resistant exterior polyurethane paint exceeds a 2,500 hour salt spray test.



▲ RZ Series Rooftop Unit

- Double sloped stainless steel drain pans eliminate standing water which can support microbial growth and stainless steel construction prevents corrosion that could lead to water leaks and contaminants in the air stream.

### Fans and Blowers

- Spring isolated direct drive backward curved plenum fans are more energy efficient, quieter, and require less maintenance than belt driven fans. These single thickness airfoil plenum blowers are quieter and more energy efficient than forward curved blowers.
- Selectable number of draw-through or blow-through direct drive backward curved plenum fans allows design flexibility for quieter applications and applications where unit uptime is critical.
- VFD controlled supply, exhaust, and return fans for precise airflow control, building pressure control, and reduced power consumption.



◀ Direct Drive Axial Flow Exhaust/Return Fans are more energy efficient and require less maintenance than belt driven fans.



## Controls

- Labeled electrical components and color-coded wiring match the unit specific color-coded wiring diagram which is laminated and permanently affixed inside the control compartment.
- Factory provided or customer provided controller can be selected to meet existing or new building control architecture.
- Unit controls are contained within a walk-in service compartment isolated from the air stream for ease of service and quiet operation. Service compartment can be independently heated.
- Run test report, color-coded wiring diagram, and Installation, Operation and Maintenance manual with startup form are included in control access compartment of every unit.

## Features and Options

- Modulating humidity control is available to provide energy efficient dehumidification, even with low sensible heat loads, without the temperature swings common with on/off reheat systems.
- High efficiency, multiple stage, gas and electric heating are available to meet job requirements.
- Factory installed, sensible or enthalpy, gear driven economizer allows for free cooling.
- Multiple high efficiency filtration options, including pleated, cartridge, or bag type, with up to a MERV 14 efficiency rating.
- Factory installed total and sensible AAONAIRE® energy recovery wheels save cooling and heating dollars. Return fans are available for high return static applications.



### AAONAIRE®

This energy recovery ventilation option can be provided in all model sizes allowing reduced equipment size and operating cost savings while pre-conditioning the outside air being introduced into the conditioned space.

- Polymer e-coated coils are available to extend the life of the coils and protect them in corrosive environments.
- Interior corrosion protection option protects interior components of the unit in corrosive environments.
- Turbocor magnetic bearing R-134a centrifugal compressor option provides load matching cooling capabilities, with quiet energy efficient operation, and the oil free design is highly reliable.
- Variable speed R-410A scroll compressors for load matching cooling and improved part load efficiency. Multiple methods of humidity control including: High Capacity Cooling Coils, Return Air Bypass, and Modulating Humidity Control which provides energy efficient dehumidification, even with low sensible heat loads, without the temperature swings common with on/off reheat systems.
- Factory installed AAON evaporative-cooled condenser, with air-cooled de-superheater and variable frequency drive controlled fans, can be 20-40% more energy efficient than a comparable air-cooled condenser, can use 22-100% less water than a conventional evaporative-cooled condenser, and require 22-100% less chemical usage than a conventional evaporative-cooled condenser.
- Interior of evaporative-cooled condenser is constructed of 304 stainless steel and other non-corrosive materials. De-superheater coils include polymer e-coating for corrosion protection.
- Factory installed, microprocessor controlled, three chemical, water treatment system is standard with an evaporative-cooled condenser saving installation and maintenance time and money.
- Factory installed shell and tube water-cooled condensers include removable and cleanable basket filters and can be factory piped to require only a single water connection at the unit.
- High efficiency, multiple stage, gas and electric heating are available to meet job requirements.

RZ Model	Nominal cfm	Width	Height	Length*
055	15,000	142	104	Length varies depending on options selected
065	17,000			
075	18,000			
090	22,000			
105	24,000			
120	29,500			
130	32,000			
140	33,000			

\*Dimension may vary depending on options selected.

All dimensions are in inches.

Design cfm may be 30-50% greater or less than nominal cfm.



# RZ Series

	R-410A Scroll Compressor Units (55-140 tons)	R-134a Turbocor Centrifugal Compressor Units (90-240 tons)
<b>Cooling Options</b>		
Blow-Through or Draw-Through Fan Configuration	✓	✓
Variable Capacity Compressors	✓	✓
Evaporative-Cooled Condenser	✓	✓
Air-Cooled Condenser	✓	
Water-Cooled Condenser	✓	
Air Handling Unit - No Cooling	✓	
Air Handling Unit - DX Coil	✓	
Air Handling Unit - Chilled Water Coil	✓	
<b>Heating Options</b>		
Electric Heat	✓	✓
Natural Gas	✓	✓
Natural Gas Modulating	✓	✓
Steam Distributing Coil	✓	✓
Hot Water Coil	✓	✓
Water-Source/Geothermal Heat Pump	✓	
<b>Unit Air Intake Options</b>		
Economizer	✓	✓
Energy Recovery Wheel - Total or Sensible	✓	✓
100% Outside Air Unit	✓	✓
<b>Serviceability Options</b>		
Factory Wired Convenience Outlet	✓	✓
Compression Isolation Valves	✓	✓
Replaceable Core Filter Dryers	Standard	Standard
Service Lights	✓	✓
<b>Filter Options</b>		
2" Pleated - 30% Efficient - MERV 8	✓	✓
4" Pleated - 30% Efficient - MERV 8	✓	✓
2" Permanent Filter Frame	✓	✓
12" Cartridge - 65% Efficient - MERV 11	✓	✓
12" Cartridge - 85% Efficient - MERV 13	✓	✓
12" Cartridge - 95% Efficient - MERV 14	✓	✓
30" Bag - 85% Efficient - MERV 13	✓	✓
30" Bag - 95% Efficient - MERV 14	✓	✓



### Walk-In Service Vestibule

The walk-in service vestibule provides shelter for the maintenance and service personnel while periodic maintenance is performed on the unit. A fluorescent light fixture is furnished in the compartment, controlled by a light switch at the door, and the vestibule can be heated and/or cooled for comfort.



### Spring Isolators

Spring isolators provide sound attenuation for the main blower section.



### Evaporator Coils

Each evaporator coil has an expansion valve. A double sloped drain pan is provided for positive drainage. Tubing is dressed and structurally supported.



◀ Spring isolated direct drive backward curved plenum fans are more efficient, have higher static pressure capacities and require less maintenance than belt driven, forward curved fans.



### Gas Heat Exchanger

Constructed from stainless steel with patented "dimple" design to maximize efficiency at all inlet air conditions. Burners have electronic ignition and safety shutdown.

# RZ Series

	R-410A Scroll Compressor Units (55-140 tons)	R-134a Turbocor Centrifugal Compressor Units (90-240 tons)
<b>Refrigeration Options</b>		
Modulating Hot Gas Reheat	✓	✓
Sight Glass	✓	✓
VFD Controlled Condenser Fans with Head Pressure Control	✓	✓
0°F Low Ambient Flooded Condenser	✓	
<b>VFD Controlled Fan Options</b>		
Supply Fans	✓	✓
Power Exhaust Fans	✓	✓
Power Return Fans	✓	✓
<b>Safety Options</b>		
Return Air Firestat	✓	✓
Supply Air Firestat	✓	✓
Supply Air Smoke Detector	✓	✓
Return Air Smoke Detector	✓	✓
<b>Control Options</b>		
Variable Air Volume (VAV)	✓	✓
Constant Air Volume	✓	✓
Single Zone VAV	✓	✓
Makeup Air Unit	✓	✓
Remote Start/Stop Terminals	✓	✓
Customer Provided Controller - Field Installed	✓	✓
Customer Provided Controller - Factory Installed	✓	✓
<b>Preheat Options</b>		
Steam Distributing Coil	✓	✓
Hot Water Coil	✓	✓
<b>Construction Options</b>		
Base Insulation	Standard	Standard
Burglar Bars	✓	✓
Access Door Windows	✓	✓
Fan Sound Attenuation	✓	✓
Single or Two Piece Unit	✓	✓
<b>Code Options</b>		
Chicago Code	✓	✓



### Blower Section

Single or multiple direct drive backward curved plenum fans with spring isolation on the entire assembly allows optimization of fan diameter, sound level, and efficiency.



### Economizer

A full line of economizer options are available. All are low leakage with extruded airfoil blades and rubber edge and aluminum end seals.



### Lockable Handles

Walk-in doors are constructed with stainless steel piano hinges, perimeter gaskets, and zinc cast lockable handles that operate from a single point.



### Optional Exhaust and Return Fans

The axial flow and plenum power exhaust and return fans are directly driven by the motor.







## Evaporative-Cooled Condenser Rooftop Unit

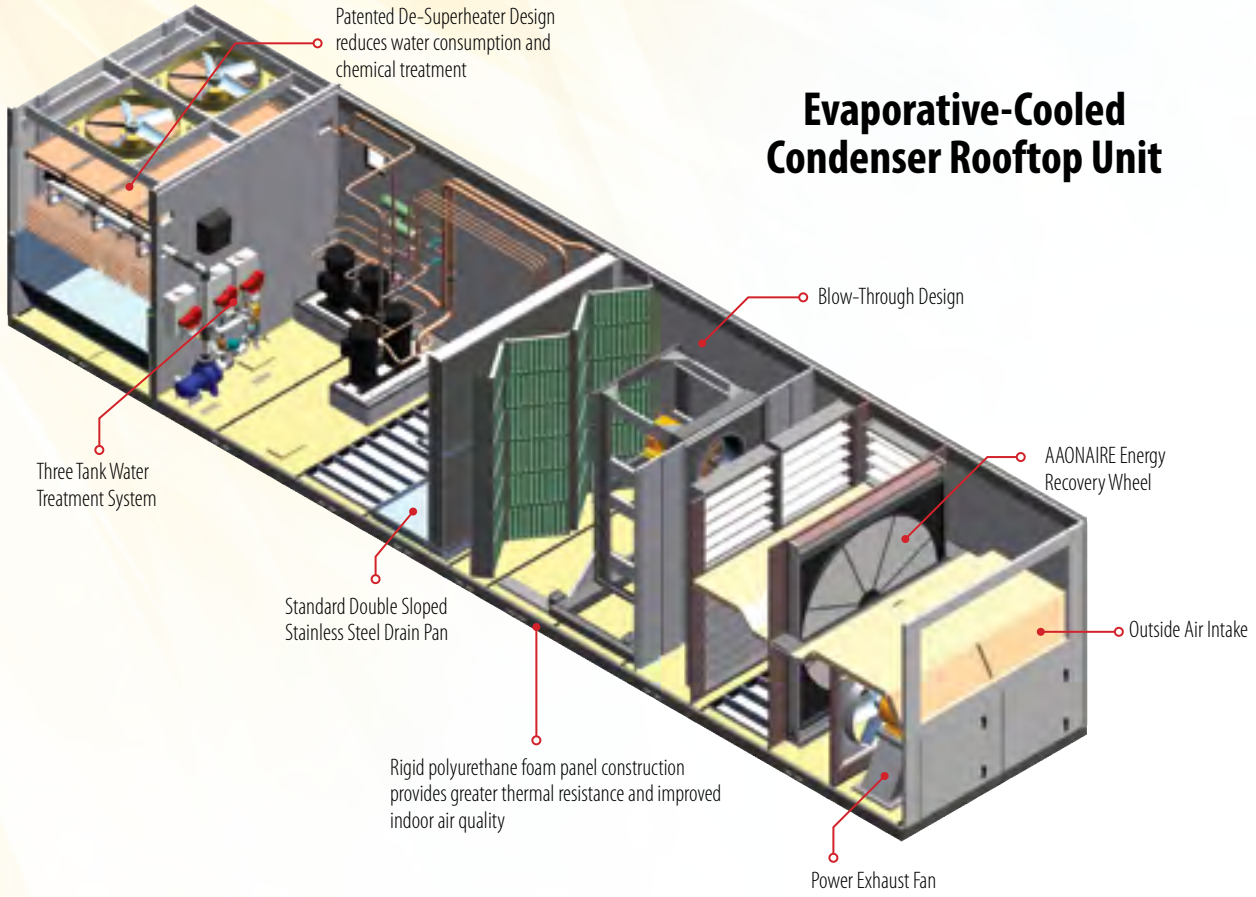

## Water-Cooled Condenser Rooftop Unit

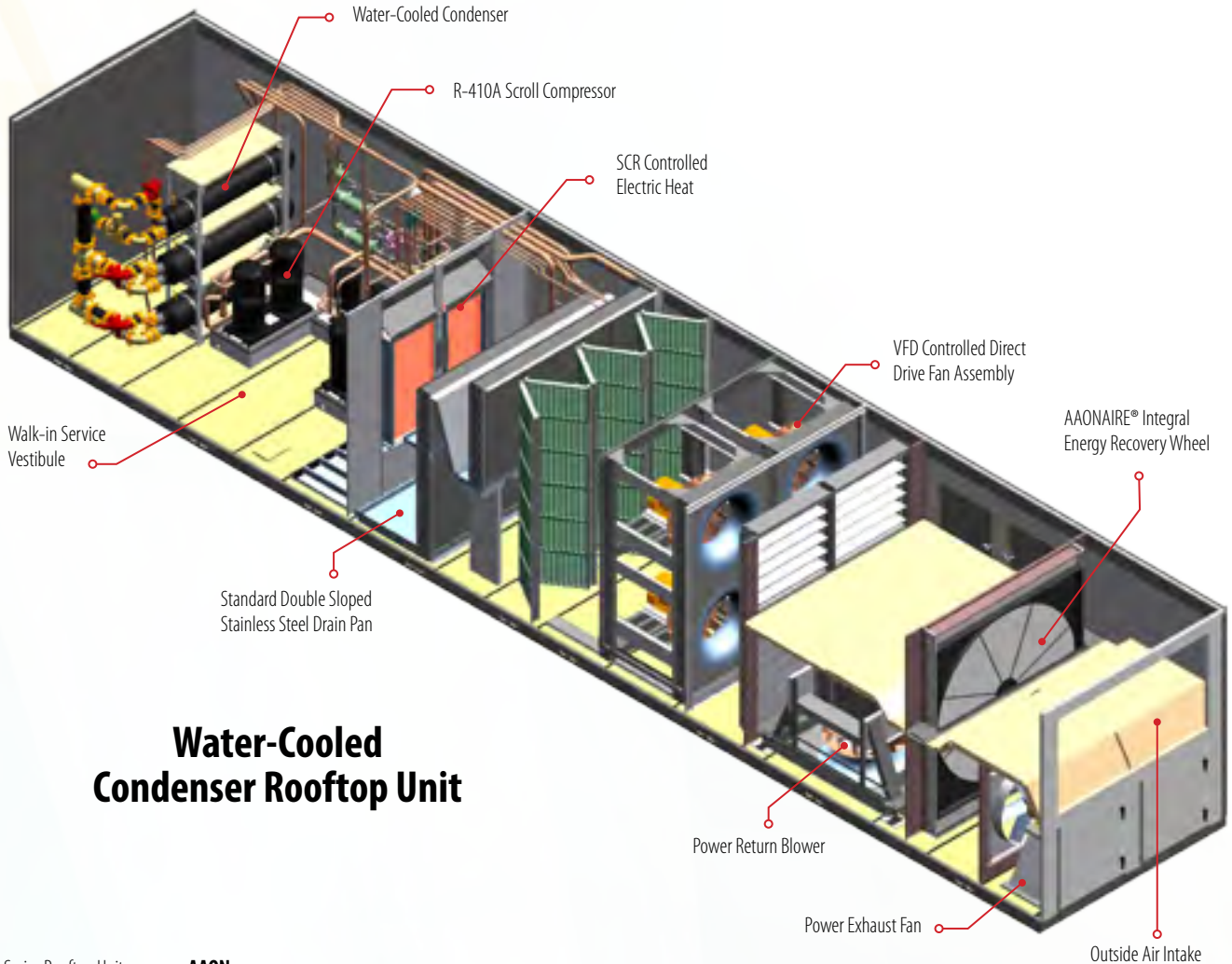



The RZ Series can be configured as either a draw-through or blow-through arrangement with supply or return fans. The supply blower assemblies are direct drive, unboxed, single inlet, single width, fans with spring isolation.

The AAON ECat selection software easily allows selection for constant or variable air flow applications. The software determines the most efficient alternatives for the application as a function of fan quantity, fan diameter, fan blade width, and rpm.

Inlet and outlet sound ratings are provided for each combination of fans and unit inlet and outlet sound ratings are determined for the overall unit configuration. Multiple fans can provide improved reliability, greater efficiency, lower sound levels, and greater service options.

### Gas Heat

A system unique to AAON, the all stainless steel design construction assures dependable, long term functionality. Through elimination of the need for internal turbulators, this unique design assures trouble free service, capacity, and efficient performance.

### Electric Heat

Electric resistance heating coils are open type with low watt density nickel chromium elements. The heating modules are 40 kW with individual circuit fusing and a manually reset high temperature limit switch.

### Hot Water and Steam Heat Coils

Hot water and steam coils are available in 1 or 2 row configurations with multiple different face areas to meet job requirements.

### Chilled Water Coils

Chilled water coils are constructed of copper tubing mechanically expanded to bond with the aluminum fins. Tube sheets are constructed of 16 GA galvanized steel and extruded holes for the copper tubing. All headers are constructed of heavy wall copper tubing

with either spun or die formed end caps. Chilled Water coils are available in 4, 6, or 8 rows deep in two different face areas for each cabinet size.

### Hot Water or Steam Preheat Coils

When jobsite conditions require, coils are available to precondition the outside air. 1 or 2 row hot water or steam coils may be supplied to match the system requirements.

### Variable Capacity Compressors

RZ Series unit are available with variable capacity compressors which allow the unit to be able to provide a consistent supply air temperature at all operating conditions. VFD driven variable speed R-410A scroll compressors are available for load matching cooling capabilities and increased part load efficiency. Variable capacity R-134a centrifugal compressors provide load matching cooling capabilities, with quiet energy efficient operation. During part load operation, reducing compressor capacity saves system operating costs.

### Flexibility

The wide range of unit sizes, capacities, airflow rates, as well as, the standard design features and the many available options make the RZ Series the wise selection.

### A Trend Setting Design

In the past when greater airflows were required, the diameter of the single plenum fan was simply increased to meet the requirement. This results in higher tip speeds, which also means higher sound levels. With the AAON RZ Series, the greater airflow rates can be accomplished with multiple fans of smaller diameter, which inherently will be quieter than a single larger diameter fan. All the fans are also directly driven by the motor, which eliminates the drive belt assembly and associated requirement for maintenance. The entire assembly is then spring mounted to further enhance the vibration isolation and reduce sound transmission.



Oil-Free Magnetic Bearing Variable Capacity Centrifugal Turbocor Compressor



Staged or VFD Driven Variable Speed Scroll Compressor



AAON **RN SERIES ROOFTOP UNITS** CONTINUE TO LEAD THE PACKAGED ROOFTOP EQUIPMENT INDUSTRY IN PERFORMANCE AND SERVICEABILITY. DOUBLE WALL RIGID POLYURETHANE FOAM INSULATED CABINET CONSTRUCTION AND DIRECT DRIVE BACKWARD CURVED PLENUM FANS ALLOW RN SERIES UNITS TO HAVE QUIET, ENERGY EFFICIENT AIRFLOW WITH HIGH STATIC PRESSURE CAPABILITIES. RN SERIES UNITS ALSO FEATURE LOCKABLE HINGED DOORS WHICH PROVIDE SERVICE ACCESS TO ALL SECTIONS OF THE UNIT.

### Applications

- Air-cooled condenser or air-source heat pump packaged DX rooftop units, 6-140 tons.
- Water-cooled condenser, water-source heat pump, or geothermal heat pump configurations.
- Makeup air capability, up to 100% outside air, to meet ventilation requirements.
- High performance hot water, steam, electric, and gas heating.
- Variable capacity and variable speed R-410A scroll compressors for load matching cooling and improved part load efficiency.

### Construction

- Two-inch double wall rigid polyurethane foam panel cabinet construction has a thermal resistance of R-13 or greater, which exceeds the R-value of a cabinet with four-inch thick fiberglass construction. Panels include a thermal break, with no metal contact from inside to outside, to prevent heat transfer through the panel and prevent condensation on the outside of the cabinet. The inner wall protects the insulation from moisture damage, prevents microbial growth, and is easy to clean. This type of construction also makes the cabinet more rigid and resistant to damage, provides increased sound dampening, and reduces air leakage and infiltration.
- Access doors with full length stainless steel piano hinges and quarter turn lockable handles provide improved reliability over single point hinges and make the unit easily serviceable.
- Corrosion resistant exterior polyurethane paint exceeds a 2,500 hour salt spray test.



▲ 26, 31-50, 60, & 70 ton RN Series Air-Cooled Condenser Packaged Rooftop Unit.

- Double sloped stainless steel drain pans eliminate standing water which can support microbial growth and stainless steel construction prevents corrosion that could lead to water leaks and contaminants in the air stream.
- AMCA Certified low leakage gear driven economizer dampers are standard on RN Series rooftop units. AAON low leakage dampers meet the California Title 24 damper air leakage requirement. Optional Economizer Fault Detection and Diagnostics is also available with the low leakage dampers to meet the California Title 24 requirements.

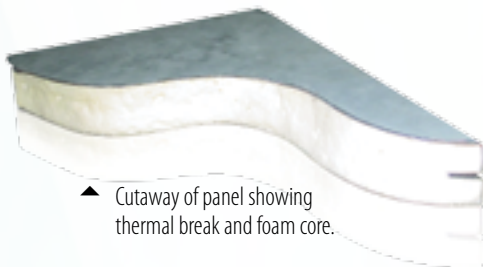

▲ Cutaway of panel showing thermal break and foam core.



◀ 11, 13, & 16-30 ton RN Series Horizontal Configuration Unit with final filtration.

## Fans and Blowers

- Direct drive backward curved plenum fans are more energy efficient, quieter, and require less maintenance than belt driven fans. These single thickness airfoil plenum blowers are quieter and more energy efficient than forward curved blowers.
- VFD controlled supply, exhaust, and return fans for precise airflow control, building pressure control, and reduced power consumption.

## Controls

- Labeled electrical components and color-coded wiring match the unit specific color-coded wiring diagram which is laminated and permanently affixed inside the control compartment.
- Factory provided or customer provided controller can be selected to meet existing or new building control architecture.
- Unit controls and compressors are contained within compartment isolated from the air stream for ease of service and quiet operation.
- Run test report, color-coded wiring diagram, and Installation, Operation and Maintenance manual with startup form is included



▲ 6 - 25 & 30 ton RN Series Air-Cooled Condenser Packaged Rooftop Unit.



▶ Dimpled heat exchanger provides energy efficient heat transfer and has no internal turbulator, which can corrode over time.

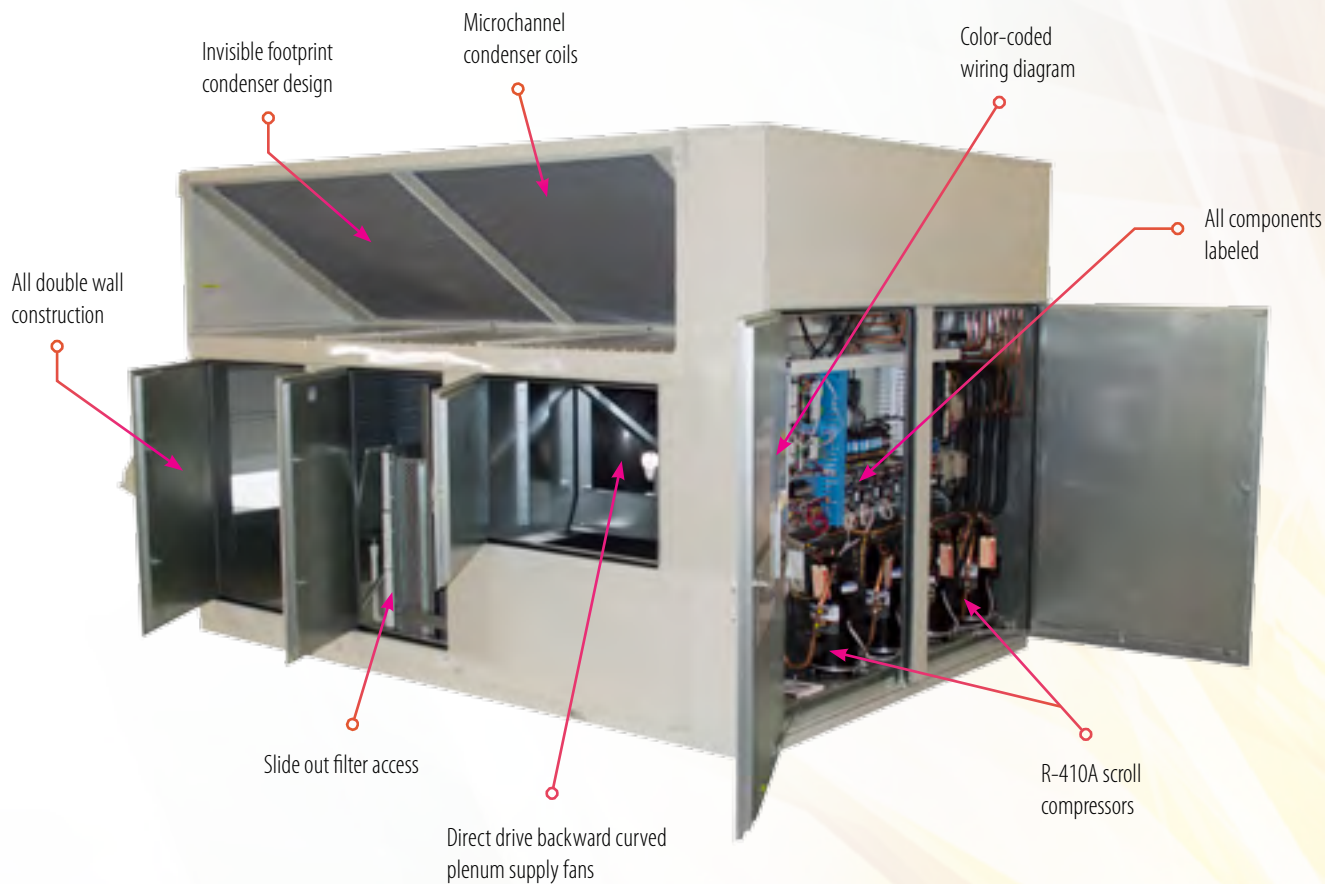





## Features and Options

- Variable capacity and variable speed R-410A scroll compressors for load matching cooling and improved part load efficiency.
- Multiple methods of humidity control including: High Capacity Cooling Coils, Return Air Bypass, Mixed Air Bypass, and Modulating Humidity Control which provides energy efficient dehumidification, even with low sensible heat loads, without the temperature swings common with on/off reheat systems.
- Modulating gas heat and SCR electric heat provide energy efficient, consistent supply air temperature heating and improved occupancy comfort.
- Factory installed, sensible or enthalpy, gear driven economizer allows for free cooling.
- Multiple high efficiency filtration options, with up to a MERV 14 efficiency rating.
- Factory installed total and sensible AAONAIRE® energy recovery wheels save cooling and heating dollars.
- Polymer e-coated coils are available to extend the life of the coils and protect them in corrosive environments.
- Interior corrosion protection option protects interior components of the unit in corrosive environments.
- VFD controlled or ECM driven condenser fans for head pressure control, reduced power consumption and lower sound levels at off-design ambient conditions.
- **Seismically certified RN Series equipment is available that passed shake table testing.**

## AMCA Certified Low Leakage Dampers



- ▲ Gear driven economizer eliminates the excess play and bind that occurs with linkage type economizers. Standard AMCA Certified AAON Low Leakage Dampers meet the California Title 24 damper air leakage requirement.



- ◀ VFD Controlled Variable Speed Scroll Compressor



- ▶ Variable capacity scroll compressors provide load matching cooling and improve part load efficiency.



- ▲ Factory installed AAONAIRE® energy recovery wheel saves heating and cooling energy.

## Horizontal Configuration

Horizontal configuration is available for RN Series units (11, 13, 16-30 tons). This configuration provides a solution for applications that require horizontal ductwork; it does not require special horizontal supply return curbs. All of the premier features and options currently available on RN units are available with this configuration. **High efficiency final filtration configuration is available on the RN Series units for healthcare and other applications that require it.**



RN Model	Cabinet	Configuration	Air-Cooled EER	Water-Cooled EER	Nominal cfm	Width*	Height*	Length*	
RN-006	A	Vertical	Up to 14.0	NA	2,000	79	44	82	
RN-007					2,500				
RN-008					2,650				
RN-010					3,000				
RN-009	B		Up to 13.9	NA	3,400	96	50	88	
RN-011					3,600				
RN-013					3,800				
RN-015					4,200				
RN-016	C		Up to 12.7	NA	6,400	101	60	110	
RN-018					6,800				
RN-020					7,000				
RN-025					9,000				
RN-030	10,500	Up to 16							
RN-026	10,000								
RN-031	12,400								
RN-040	16,000								
RN-050	D	Up to 12.2	Up to 16.5	20,000	100	102	155		
RN-060				23,000					
RN-070				25,000					
RN-055				15,000				Up to 15.2	142
RN-065	17,000								
RN-075	18,000								
RN-090	22,000								
RN-105	24,000		303						
RN-120	29,500								
RN-130	32,000								
RN-140	33,000								
RNA-11	C	Horizontal	Up to 12.7	Up to 16	3,600	101	60	138	
RNA-13					3,800				
RNA-16					6,400				
RNA-18					6,800				
RNA-20					7,000				
RNA-25					9,000				
RNA-30					10,500				



▲ Microchannel condenser coils are more efficient, lighter, and use less refrigerant than traditional fin and tube condenser coils.



◀ 55, 65 and 75-140 ton RN Series Air-Cooled Condenser Packaged Rooftop Unit with Microchannel Condenser Coils.



# RN Series

	A Cabinet (6-8 & 10)	B Cabinet (9 & 11-15)	C Cabinet (16-25 & 30)	D Cabinet (26 & 31-50, 60, 70)	E Cabinet (55, 65 & 75-140)
<b>Configuration Options</b>					
Vertical	✓	✓	✓	✓	✓
Horizontal			✓		
<b>Cooling Options</b>					
Number of Compressors/Circuits	1/1	2/2	2/2	4/4	4/2
10-100% Variable Capacity Compressors	✓	✓	✓	✓	
Variable Speed Compressors					✓
Air Handling Unit - No Cooling	✓	✓	✓	✓	✓
Air Handling Unit - DX Coil	✓	✓	✓	✓	✓
Air Handling Unit - Chilled Water Coil	✓	✓	✓	✓	✓
<b>Heating Options</b>					
Electric Heat	✓	✓	✓	✓	✓
Natural Gas	✓	✓	✓	✓	✓
Natural Gas Modulating	✓	✓	✓	✓	✓
LP Gas	✓	✓	✓	✓	✓
Steam Distributing Coil	✓	✓	✓	✓	✓
Hot Water Coil	✓	✓	✓	✓	✓
Air-Source Heat Pump	✓	✓	✓	✓	
Water-Source/Geothermal Heat Pump	✓	✓	✓	✓	✓
<b>Unit Air Intake Options</b>					
Economizer	✓	✓	✓	✓	✓
Energy Recovery Wheel - Total or Sensible	✓	✓	✓	✓	✓
100% Outside Air Unit	✓	✓	✓	✓	✓
100% Return Air Unit	✓	✓	✓	✓	✓
<b>Serviceability Options</b>					
Factory Wired Convenience Outlet	✓	✓	✓	✓	✓
Compression Isolation Valves	✓	✓	✓	✓	✓
Service Lights	✓	✓	✓	✓	✓
<b>Filter Options</b>					
Metal Mesh Pre Filter	✓	✓	✓	✓	✓
Lint Screen Pre Filter	✓	✓	✓	✓	✓
2" Pleated - 30% Efficient - MERV 8	✓	✓	✓	✓	✓
4" Pleated - 30% Efficient - MERV 8	✓	✓	✓	✓	✓
2" Permanent Filter Frame	✓	✓	✓	✓	✓
4" Pleated - 65% Efficient - MERV 11	✓	✓	✓	✓	✓
4" Pleated - 85% Efficient - MERV 13	✓	✓	✓	✓	✓
4" Pleated - 95% Efficient - MERV 14	✓	✓	✓	✓	✓

# RN Series

	A Cabinet (6-8 & 10)	B Cabinet (9 & 11-15)	C Cabinet (16-25 & 30)	D Cabinet (26 & 31-50, 60, 70)	E Cabinet (55, 65 & 75-140)
<b>Refrigeration Options</b>					
Microchannel Condenser Coils	✓	✓	✓	✓	✓
Modulating Hot Gas Reheat	✓	✓	✓	✓	✓
0°F Low Ambient Flooded Condenser	✓	✓	✓	✓	✓
Sight Glass	✓	✓	✓	✓	✓
Interlaced Evaporator Coil	Single Circuit	✓	✓	✓	55-75 ✓ 120-140 ✓
<b>Condenser Fan Options</b>					
ECM Driven Condenser Fans with Head Pressure Control	✓	✓	✓	✓	
VFD Controlled Condenser Fans with Head Pressure Control	✓	✓	✓	✓	✓
<b>Safety Options</b>					
Return Air Firestat	✓	✓	✓	✓	✓
Supply Air Firestat	✓	✓	✓	✓	✓
Return Air Smoke Detector	✓	✓	✓	✓	✓
Supply Air Smoke Detector	✓	✓	✓	✓	✓
<b>Control Options</b>					
Variable Air Volume (VAV)	✓	✓	✓	✓	✓
Constant Air Volume	✓	✓	✓	✓	✓
Single Zone VAV	✓	✓	✓	✓	✓
Makeup Air Unit	✓	✓	✓	✓	✓
Remote Start/Stop Terminals	✓	✓	✓	✓	✓
Customer Provided - Field Installed	✓	✓	✓	✓	✓
Customer Provided - Factory Installed	✓	✓	✓	✓	✓
<b>Preheat Options</b>					
Steam Distributing Coil	✓	✓	✓	✓	✓
Hot Water Coil	✓	✓	✓	✓	✓
Electric Preheat	✓	✓	✓		
<b>Construction Options</b>					
Base Insulation	✓	✓	✓	Standard	Standard
Burglar Bars	✓	✓	✓	✓	✓
<b>Code Options</b>					
Chicago Code	✓	✓	✓	✓	✓
California OSHPD - Seismic Certified	✓	✓	✓	✓	
Shake Table Certified	✓	✓	✓	✓	
Seismic Construction	✓	✓	✓	✓	



AAON **RQ SERIES ROOFTOP UNITS** CONTINUE TO LEAD THE PACKAGED ROOFTOP EQUIPMENT INDUSTRY IN PERFORMANCE AND SERVICEABILITY. DOUBLE WALL RIGID POLYURETHANE FOAM INSULATED CABINET CONSTRUCTION AND DIRECT DRIVE BACKWARD CURVED PLENUM FANS ALLOW RQ SERIES UNITS TO HAVE QUIET, ENERGY EFFICIENT AIRFLOW WITH HIGH STATIC PRESSURE CAPABILITIES. RQ SERIES UNITS ALSO FEATURE LOCKABLE HINGED DOORS WHICH PROVIDE SERVICE ACCESS TO ALL SECTIONS OF THE UNIT.

### Applications

- Air-cooled condenser or air-source heat pump packaged DX rooftop units, 2-6 tons.
- Water-source heat pump or geothermal heat pump configurations.
- Makeup air capability, up to 100% outside air, to meet ventilation requirements.
- High performance hot water, steam, electric, and gas heating.
- Variable capacity and two step R-410A scroll compressors for load matching cooling and improved part load efficiency.

### Construction

- Two-inch double wall rigid polyurethane foam panel cabinet construction has a thermal resistance of R-13 or greater, which exceeds the R-value of a cabinet with four-inch thick fiberglass construction. Panels include a thermal break, with no metal contact from inside to outside, to prevent heat transfer through the panel and prevent condensation on the outside of the cabinet. The inner wall protects the insulation from moisture damage, prevents microbial growth, and is easy to clean. This type of construction also makes the cabinet more rigid and resistant to damage, provides increased sound dampening, and reduces air leakage and infiltration.
- Access doors with full length stainless steel piano hinges and quarter turn lockable handles provide improved reliability over single point hinges and make the unit easily serviceable.
- Corrosion resistant exterior polyurethane paint exceeds a 2,500 hour salt spray test.

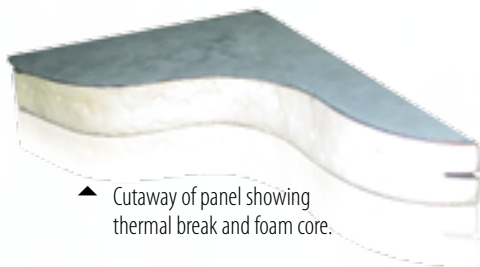

▲ Cutaway of panel showing thermal break and foam core.



▲ 2-6 ton RQ Series Air-Cooled Condenser Packaged Rooftop Unit



#### Don't see the specific product you need?

AAON can meet your requirements with Custom Equipment designed specifically for your exact application and job specifications. Visit [www.aaon.com/repsearch](http://www.aaon.com/repsearch) or call 918.583.2266 to locate a representative near you.

- Double sloped stainless steel drain pans eliminate standing water which can support microbial growth and stainless steel construction prevents corrosion that could lead to water leaks and contaminants in the air stream.
- Microchannel condenser coils are more efficient, lighter, and use less refrigerant than traditional fin and tube condenser coils.
- AMCA Certified low leakage gear driven economizer dampers are standard on RN Series rooftop units. AAON low leakage dampers meet the California Title 24 damper air leakage requirement. Optional Economizer Fault Detection and Diagnostics is also available with the low leakage dampers to meet the California Title 24 requirements.



## Fans and Blowers

- Direct drive backward curved plenum fans are more energy efficient, quieter, and require less maintenance than belt driven fans. These single thickness airfoil plenum blowers are quieter and more energy efficient than forward curved blowers.
- VFD controlled or ECM driven supply, exhaust, and return fans for precise airflow control, building pressure control, and reduced power consumption.

## Controls

- Labeled electrical components and color-coded wiring match the unit specific color-coded wiring diagram which is laminated and permanently affixed inside the control compartment.
- Factory provided or customer provided controller can be selected to meet existing or new building control architecture.
- Unit controls and compressors are contained within compartment isolated from the air stream for ease of service and quiet operation.
- Run test report, color-coded wiring diagram, and Installation, Operation and Maintenance manual with startup form is included in control access compartment of every unit.

▼ Access doors make the unit easily serviceable.



## Features and Options

- Variable capacity and two step R-410A scroll compressors for load matching cooling and improved part load efficiency.
- Multiple methods of humidity control including: High Capacity Cooling Coils, Return Air Bypass, Mixed Air Bypass, and Modulating Humidity Control which provides energy efficient dehumidification, even with low sensible heat loads, without the temperature swings common with on/off reheat systems.
- Modulating gas heat and SCR electric heat provide energy efficient, consistent supply air temperature heating and improved occupancy comfort.
- Factory installed, sensible or enthalpy, gear driven economizer allows for free cooling.
- Multiple high efficiency filtration options, with up to a MERV 14 efficiency rating.
- Factory installed total and sensible AAONAIR® energy recovery wheels save cooling and heating dollars.
- Polymer e-coated coils are available to extend the life of the coils and protect them in corrosive environments.
- Interior corrosion protection option protects interior components of the unit in corrosive environments.
- ECM driven condenser fans for head pressure control, reduced power consumption and lower sound levels at off-design ambient conditions.
- **Seismically certified RQ Series equipment is available that passed shake table testing.**

## Horizontal Configuration

Horizontal configuration is available for RQ Series units (2-6 tons). This configuration provides a solution for applications that require horizontal ductwork; it does not require special horizontal supply/return curbs. All of the premier features and options currently available for the RQ units are available with this configuration.

RQ Model	Configuration	Air-Cooled SEER	Air-Cooled EER	Nominal cfm	Width	Height*	Length*
RQ-002	Vertical or Horizontal	Up to 19.2	Up to 14.8	850	44	50	82
RQ-003				1,050			
RQ-004				1,400			
RQ-005				1,750			
RQ-006				1,800			



\*Dimensions vary depending on options selected.  
All dimensions are in inches.

Design cfm may be 30-50% greater or less than nominal cfm.



# RQ Series

	2 ton (800 cfm)	3 ton (1,200 cfm)	4 ton (1,600 cfm)	5 ton (2,000 cfm)	6 ton (2,400 cfm)
<b>Configuration Options</b>					
Vertical	✓	✓	✓	✓	✓
Horizontal	✓	✓	✓	✓	✓
<b>Cooling Options</b>					
Number of Compressors	1	1	1	1	1
2-Step Compressor	✓	✓	✓	✓	✓
10-100% Variable Capacity Compressor		✓	✓	✓	✓
Air Handling Unit - No Cooling	✓	✓	✓	✓	✓
Air Handling Unit - DX Coil	✓	✓	✓	✓	✓
Air Handling Unit - Chilled Water Coil	✓	✓	✓	✓	✓
<b>Heating Options</b>					
Electric Heat	✓	✓	✓	✓	✓
Natural Gas	✓	✓	✓	✓	✓
Natural Gas Modulating	✓	✓	✓	✓	✓
LP Gas	✓	✓	✓	✓	✓
Steam Distributing Coil	✓	✓	✓	✓	✓
Hot Water Coil	✓	✓	✓	✓	✓
Air-Source Heat Pump	✓	✓	✓	✓	✓
Water-Source/Geothermal Heat Pump	✓	✓	✓	✓	✓
<b>Unit Air Intake Options</b>					
Economizer	✓	✓	✓	✓	✓
Energy Recovery Wheel	✓	✓	✓	✓	✓
Cross-Flow Fixed Plate Energy Recovery - Total or Sensible	✓	✓	✓	✓	✓
100% Outside Air Unit	✓	✓	✓	✓	✓
100% Return Air Unit	✓	✓	✓	✓	✓
<b>Serviceability Options</b>					
Factory Wired Convenience Outlet	✓	✓	✓	✓	✓
Compression Isolation Valves	✓	✓	✓	✓	✓
Service Lights	✓	✓	✓	✓	✓
<b>Filter Options</b>					
Metal Mesh Pre Filter	✓	✓	✓	✓	✓
Lint Screen Pre Filter	✓	✓	✓	✓	✓
2" Throwaway	✓	✓	✓	✓	✓
2" Pleated - 30% Efficient - MERV 8	✓	✓	✓	✓	✓
4" Pleated - 30% Efficient - MERV 8	✓	✓	✓	✓	✓
2" Permanent Filter Frame	✓	✓	✓	✓	✓
4" Pleated - 65% Efficient - MERV 11	✓	✓	✓	✓	✓
4" Pleated - 85% Efficient - MERV 13	✓	✓	✓	✓	✓

# RQ Series

	2 ton (800 cfm)	3 ton (1,200 cfm)	4 ton (1,600 cfm)	5 ton (2,000 cfm)	6 ton (2,400 cfm)
<b>Refrigeration Options</b>					
Microchannel Condenser Coils	✓	✓	✓	✓	✓
Modulating Hot Gas Reheat	✓	✓	✓	✓	✓
0°F Low Ambient Flooded Condenser	✓	✓	✓	✓	✓
Sight Glass	✓	✓	✓	✓	✓
<b>Condenser Fan Options</b>					
ECM Condenser Fans with Head Pressure Control	✓	✓	✓	✓	✓
<b>Safety Options</b>					
Return Air Firestat	✓	✓	✓	✓	✓
Supply Air Firestat	✓	✓	✓	✓	✓
Return Air Smoke Detector	✓	✓	✓	✓	✓
Supply Air Smoke Detector	✓	✓	✓	✓	✓
<b>Control Options</b>					
Variable Air Volume (VAV)	✓	✓	✓	✓	✓
Constant Air Volume	✓	✓	✓	✓	✓
Single Zone VAV	✓	✓	✓	✓	✓
Makeup Air Unit	✓	✓	✓	✓	✓
Remote Start/Stop Terminals	✓	✓	✓	✓	✓
Customer Provided - Field Installed	✓	✓	✓	✓	✓
Customer Provided - Factory Installed	✓	✓	✓	✓	✓
<b>Preheat Options</b>					
Steam Distributing Coil	✓	✓	✓	✓	✓
Hot Water Coil	✓	✓	✓	✓	✓
Electric Preheat	✓	✓	✓	✓	✓
<b>Construction Options</b>					
Base Insulation	✓	✓	✓	✓	✓
Burglar Bars	✓	✓	✓	✓	✓
<b>Code Options</b>					
Chicago Code	✓	✓	✓	✓	✓
California OSHPD - Seismic Certified	✓	✓	✓	✓	✓
Shake Table Certified	✓	✓	✓	✓	✓
Seismic Construction	✓	✓	✓	✓	✓

# GEOHERMAL & WATER-SOURCE HEAT PUMPS

(Rooftop Units, Self-Contained Units, & Split Systems)



AAON **GEOTHERMAL AND WATER-SOURCE HEAT PUMPS** USE THE CONSTANT TEMPERATURE OF THE EARTH AS THE EXCHANGE MEDIUM INSTEAD OF THE OUTSIDE AIR TEMPERATURE. A FEW FEET BELOW THE EARTH'S SURFACE THE GROUND REMAINS AT A RELATIVELY CONSTANT TEMPERATURE. DEPENDING ON LATITUDE, GROUND TEMPERATURES RANGE FROM 45°F TO 75°F. THIS GROUND TEMPERATURE IS WARMER THAN THE AIR ABOVE IT DURING THE WINTER AND COOLER THAN THE AIR IN THE SUMMER. THE GEOTHERMAL HEAT PUMP TAKES ADVANTAGE OF THIS CONSTANT TEMPERATURE BY EXCHANGING HEAT WITH THE EARTH THROUGH A GROUND HEAT EXCHANGER.

---

AAON air conditioning and air handling units are designed with heat pump capabilities. AAON heat pumps include double wall rigid polyurethane foam panel construction, direct drive backward curved plenum fans, economizers, energy recovery, and electric, gas, steam, and hot water auxiliary heating.

### **Rooftop Units**

- RL Series is available as a geothermal or water-source heat pump from 45 – 230 tons
- RZ Series is available as a geothermal or water-source heat pump from 55 – 140 tons
- RN Series is available as a geothermal or water-source heat pump from 6-140 tons
- RQ Series is available as a geothermal or water-source heat pump from 2 – 6 tons

### **Self-Contained Units**

- SA Series is available as a geothermal or water-source heat pump from 23 – 70 tons
- SB Series is available as a geothermal or water-source heat pump from 3-18 tons
- M2 Series is available as a geothermal or water-source heat pump from 3 – 70 tons
- WH/WV Series is available as a geothermal or water-source heat pump from ½ – 15 tons

### **Split Systems**

- CF Series condensing units can be matched with M3, M2, SA, H3/ V3 and F1 Series indoor air handling units and M3, RZ, RL, RN, and RQ Series outdoor air handling units as a geothermal or water-source heat pump from 2 –70 tons
- SB Series can be factory split and matched with H3 or V3 Series indoor air handling units from 3-18 tons.

### **AAON Geothermal and Water-Source Heat Pump Advantages**

**High Efficiency** - Constant Heat Transfer Temperatures, Direct Drive Backward Curved Plenum Fans, Double Wall Rigid Polyurethane Foam Panel Construction, 10 – 100% Variable Capacity Scroll Compressors, Variable Speed Scroll Compressors

**Flexibility** - Factory Installed Energy Recovery Wheels, High Efficiency Filtration, Modulating Hot Gas Reheat Humidity Control, Makeup Air Capability, R-410A Scroll Compressors, Economizers, Variable Speed Supply, Return, and Exhaust Fans, Factory Installed Control Options

**Serviceability** - Hinged Access Doors, Access to All Sections of the Unit, Color-Coded Wiring

**Solutions** - Replacement or New Construction, LEED Points, Power Company Rebates, Tax Incentives

# AIR-SOURCE HEAT PUMPS

(Rooftop Units & Split Systems)

AAON **AIR-SOURCE HEAT PUMPS** CAN PROVIDE ENERGY EFFICIENT COOLING AND HEATING USING THE UNIT'S REFRIGERATION CIRCUIT. REVERSING THE FLOW OF THE UNIT'S REFRIGERATION CIRCUITS ALLOWS THE INDOOR COIL TO BE USED AS A HEATING COIL. THIS IS A MORE EFFICIENT METHOD OF HEATING THAN ELECTRIC RESISTANCE HEATING BECAUSE A HEAT PUMP CAN REJECT MORE HEAT TO THE SPACE PER THE AMOUNT OF ENERGY USED. THUS, THE OPERATING COSTS OF HEAT PUMP HEATING ARE ALWAYS LESS THAN THE OPERATING COSTS OF ELECTRIC RESISTANCE HEATING. HEAT PUMP HEATING IS ALSO A MORE EFFICIENT METHOD OF HEATING THAN GAS HEATING AND, DEPENDING ON THE COST OF ELECTRICITY AND NATURAL GAS OR PROPANE, HEAT PUMP HEATING CAN HAVE LESS OPERATING COSTS THAN GAS HEATING.

---

All of the standard features and premier options available on AAON air conditioning and air handling units are available on AAON heat pumps, including double wall rigid polyurethane foam panel construction, AAONAIRE energy recovery wheels, and electric, gas, steam, and hot water auxiliary heating.

### **Rooftop Units**

- RL Series is available as an air-source heat pump from 45 - 230 tons
- RN Series is available as an air-source heat pump from 6 - 70 tons
- RQ Series is available as an air-source heat pump from 2 - 6 tons

### **Split Systems**

CN Series condensing units can be matched with M3 or M2 Series indoor air handling units and M3, RZ, RL, and RN Series outdoor air handling units as a natatorium dehumidifier from 268 - 590 lbw/hr (55 - 140 tons)

CF Series condensing units can be matched with M3, M2, SA, and H3/V3 Series indoor air handling units and M3, RZ, RL, RN, and RQ Series outdoor air handling units as a natatorium or pool room dehumidifier from 12 - 305 lbw/hr (2 - 70 tons)

CB Series condensing units can be matched with H3/V3 and F1 Series indoor air handling units and RQ Series outdoor air handling units as an air-source heat pump from 2 - 5 tons

### **AAON Air-Source Heat Pump Advantages**

**High Efficiency** - Direct Drive Backward Curved Plenum Fans, Double Wall Rigid Polyurethane Foam Panel Construction or greater, 10 - 100% Variable Capacity Scroll Compressors, Variable Speed Scroll Compressors

**Flexibility** - Factory Installed Energy Recovery Wheels, High Efficiency Filtration, Modulating Hot Gas Reheat Humidity Control, Makeup Air Capability, R-410A Scroll Compressors, Economizers, Variable Speed Supply, Return, and Exhaust Fans, Factory Installed Controls Options

**Serviceability** - Hinged Access Doors, Access to All Sections of the Unit, Color-Coded Wiring

**Solutions** - Replacement or New Construction, LEED Points, Power Company Rebates, Tax Incentives

# NATATORIUM POOL ROOM UNITS

(Rooftop Units, Self-Contained Units & Split Systems)



**AAON DRY NATATORIUM AND POOL ROOM DEHUMIDIFIERS** PRECISELY CONTROL TEMPERATURE AND HUMIDITY. CONTROLLING THE TEMPERATURE AND HUMIDITY OF A NATATORIUM OR POOL ROOM CAN BE DIFFICULT BECAUSE BOTH SWIMMERS AND SPECTATORS MUST BE KEPT COMFORTABLE, EVEN WITH WIDE VARIATIONS IN OCCUPANCY AND ACTIVITY, AND SPACE CONDITIONS MUST ALSO MINIMIZE POOL WATER EVAPORATION TO LOWER OPERATING COSTS. AAON DRY UNITS ARE ESSENTIAL IN CREATING A COMFORTABLE INDOOR POOL ENVIRONMENT. THE UNIQUE DESIGN IS AVAILABLE WITH AN ENERGY RECOVERY WHEEL TO CAPTURE AND REUSE ENERGY, RESULTING IN OPTIMAL ENVIRONMENTAL CONTROL, HIGH ENERGY EFFICIENCY AND LOW OPERATING COSTS.

**AAON offers complete packaged dehumidification systems from 12 lbw/hr to 953 lbw/hr (2 - 230 tons).**

### Rooftop Units

- RL Series is available as a natatorium dehumidifier from 197 lbw/hr - 953 lbw/hr (45 - 230 tons)
- RZ Series is available as a natatorium dehumidifier from 197 lbw/hr - 590 lbw/hr (55 - 140 tons)
- RN Series is available as a natatorium or pool room dehumidifier from 40 lbw/hr - 590 lbw/hr (6-140 tons)
- RQ Series is available as a natatorium or pool room dehumidifier from 12 lbw/hr - 40 lbw/hr (2 - 6 tons)

### Self-Contained Units

- SA Series is available as a natatorium or pool room dehumidifier from 98 lbw/hr - 305 lbw/hr (23 - 70 tons)
- SB Series is available as a natatorium or pool room dehumidifier from 13 lbw/hr - 78 lbw/hr (3 - 18 tons)

### Split Systems

CN Series condensing units can be matched with M3 or M2 Series indoor air handling units and M3, RL, and RN Series outdoor air handling units as a natatorium dehumidifier from 268 - 590 lbw/hr (55 - 140 tons)

CF Series condensing units can be matched with M3, M2, SA, and H3/V3 Series indoor air handling units and M3, RL, RN, and RQ Series outdoor air handling units as a natatorium or pool room dehumidifier from 12 - 305 lbw/hr (2 - 70 tons)

CB Series condensing units can be matched with H3/V3 Series indoor air handling units and RQ Series outdoor air handling units as a natatorium or pool room dehumidifier from 12 - 39 lbw/hr (2 - 5 tons)

**Corrosion Resistant** - Double Wall Construction, Exterior and Interior Corrosion Protection, TEFC motors, Stainless Steel Gas Heat Exchangers, Polymer E-Coated Coils, Stainless Steel Drain Pans

### AAON Natatorium or Pool Room Dehumidifier Advantages

**High Efficiency** - Direct Drive Backward Curved Plenum Fans, Double Wall Rigid Polyurethane Foam Panel Construction or greater, 10 - 100% Variable Capacity Scroll Compressors, Variable Speed Scroll Compressors

**Flexibility** - Factory Installed Total and Sensible Energy Recovery Wheels, High Efficiency Filtration, Modulating Hot Gas Reheat Humidity Control, Makeup Air Capability, R-410A Scroll Compressors, Economizers, Variable Speed Supply, Return, and Exhaust Fans, Factory Installed Control Options

**Serviceability** - Hinged Access Doors, Access to All Sections of the Unit, Color-Coded Wiring

**Solutions** - Replacement or New Construction, Small, Medium, and Large Indoor Swimming Pools, Exercise and Fitness Club Pools, Therapeutic Pools, Spas and Hot Tubs, Hotel and Motel Pools, Public and Institutional Pools, Indoor Aquatic Centers, Indoor Water Parks

# AAON QUICK SELECTION

**Airflow (cfm)**

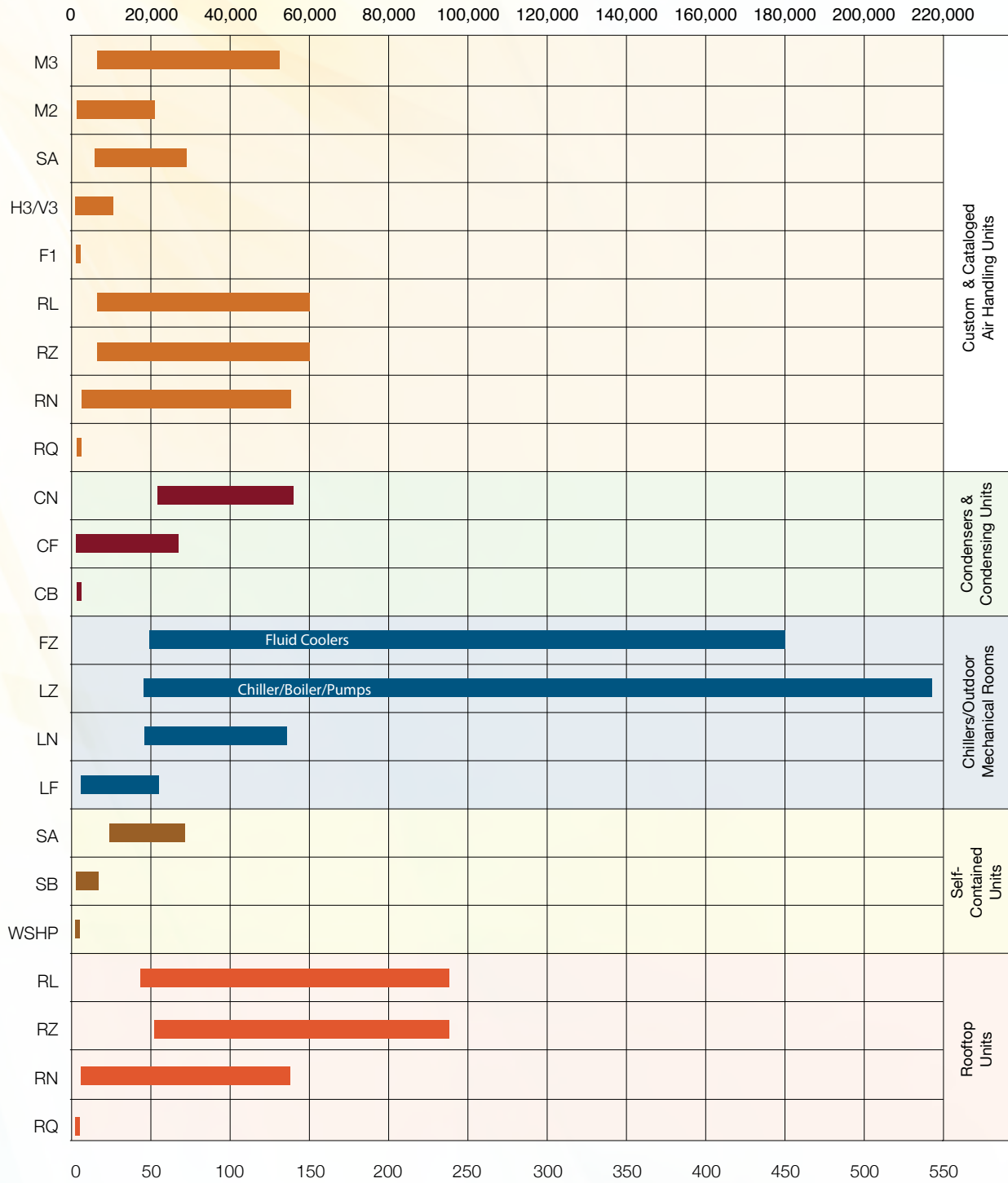

**Nominal Cooling (tons)**



**Don't see the specific product you need?** AAON can meet your requirements with Custom Equipment designed specifically for your exact application and job specifications. Visit [www.aon.com/repsearch](http://www.aon.com/repsearch) or call 918.583.2266 to locate a representative near you.

# CONTROLS

(FACTORY PROVIDED & CUSTOMER PROVIDED)



THE **AAON TOUCHSCREEN CONTROLLER** IS A FACTORY PROVIDED AAON CONTROL SYSTEM DESIGNED AS AN ECONOMICAL UNIT CONTROLLER SOLUTION THAT IS COMPATIBLE WITH A WIDE RANGE OF APPLICATIONS. IT IS DESIGNED SPECIFICALLY FOR USE WITH HIGH EFFICIENCY AAON PACKAGED EQUIPMENT AND CAN CONTROL SYSTEMS WITH UP TO TWO TOTAL COMPRESSORS AND UP TO TWO VARIABLE CAPACITY COMPRESSORS.

## Touchscreen Controller System Hardware



**Touchscreen Controller** - Mounted in the Space

*Backplate with Terminal Block*



**Unit Control Board** - Mounted in the AAON Equipment

### APPLICATIONS

- Constant Air Volume
- Single Zone Variable Air Volume (Single Zone VAV)
- Make-up Air
- Variable Air Volume

#### System applications include:

- Air-Cooled
- Air-Source Heat Pump
- Water-Source Heat Pump
- Chilled Water Air Handling Unit

### AAON Products

#### Rooftop Units (Up to 2 compressors)

- RQ and RN Series

#### Self-Contained Units (Up to 2 compressors)

- SB, SA, and M2 Series

#### Chilled Water Air Handling Units

- RQ, RN, H3, V3, SA and M2 Series



## TOUCHSCREEN INTERFACE

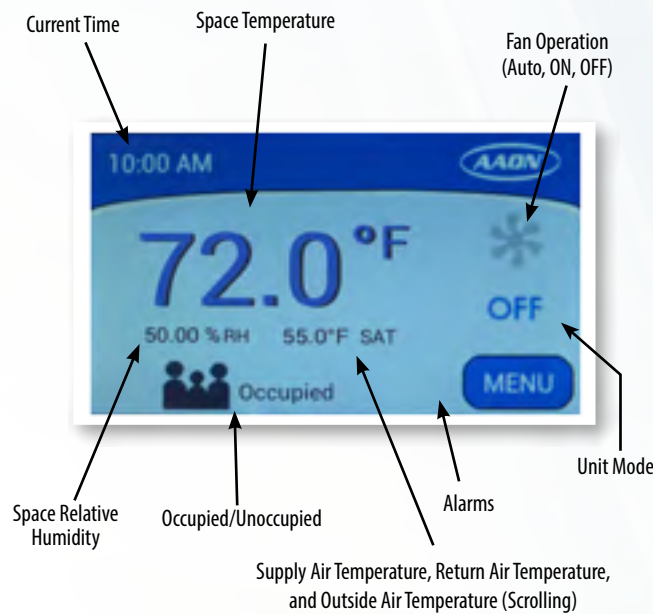

## FEATURES

- Designed to be space mounted, the Touchscreen Controller includes built-in temperature and humidity sensing, as well as easy access to occupancy scheduling.
- User-friendly, high-contrast, 4.3 inch touchscreen interface.
- In addition to the built-in sensors, multiple inputs are available for external sensors, which include options for modulating hot gas reheat, sensible and enthalpy economizer, CO<sub>2</sub> indoor air quality control, clogged filter switch, condenser head pressure control, energy recovery, and outside airflow monitoring.
- Display of space temperature, space relative humidity, supply air temperature, return air temperature, and outside air temperature depending on options selected.
- Can be used with remote space temperature sensor and remote humidity sensor allowing Touchscreen Controller to be located in an office or mechanical room.
- Separate Admin, Operator, and User password protected profiles. Three levels of access prevent disruption of operation and configuration.
- During installation, easily select from the built-in, factory tested library of application control sequences.
- Built-in occupancy scheduling with Weekly, Weekday/Weekend, and Daily options for easy configuration.
- Multiple built-in alarms enhance system monitoring.
- Can be configured to control variable capacity compressor lead stage or variable capacity compressor all stages, with control of up to two total compressors.
- Can be configured for up to four stages of heating, modulating gas heat, or SCR electric heat.
- Chilled water and hot water fully modulating valve control for air handling unit applications.

### Touchscreen Controller

### UNIT



**B** = Communication  
**A** = Communication  
**S** = Shield for Communication  
**24** = 24 VDC  
**C** = Common

18 GA/5 Stranded Wire, Max 2500 ft

**Field Installed Wiring** - From the Controller in the Space to the AAON Equipment

THE **WATTMASTER ORION CONTROL SYSTEMS CONTROLLER** WAS DEVELOPED TO PROVIDE A POWERFUL YET SIMPLE CONTROL SOLUTION FOR AAON EQUIPMENT. THE VCM-X, VCB-X, AND VCC-X ALLOW USERS TO TAKE FULL ADVANTAGE OF AAON EXCLUSIVE FEATURES WITHOUT THE ADDITIONAL COST OR COMPLEXITY OF DESIGNING A UNIQUE CONTROL STRATEGY FOR EACH JOB.

### VCM-X, VCB-X, & VCC-X Advantages

- Controllers can operate as a stand-alone system, interconnected together, or networked together.
- Only simple field configuration is needed to start up equipment. Controller requires no additional programming because all control applications and operational features are factory embedded.
- Operator interface options include handheld Modular Service Tool, wall mounted System Manager, wall mounted Touch Screen System Manager, or PC with free Prism II configuration software.
- Protocol Adaptability™ is available for interfacing to LonWorks®, BACnet®, or Johnson Controls N2™ control systems.
- Remote connectivity via dial-up or internet connections.
- Control capabilities include among many others: Variable air volume, constant volume, makeup air, advanced dehumidification strategies, heat pump heating, variable air volume heat pump cooling and heating, building pressure control, indoor air quality control (CO<sub>2</sub>), modulating DX cooling, and makeup air/constant volume.



*The VCM-X controller is designed with 7 analog inputs, 2 analog outputs, and 5 relay outputs. The controller can be configured for control of VAV Units (with or without VAV/Zone Controllers), Constant Volume Units, and Makeup Air Units. Most common HVAC unit control applications can be configured using only the VCM-X Controller. If the application requires more inputs and/or outputs, optional expansion modules are available to provide for additional analog, binary, or digital inputs and outputs as required.*



*The VCB-X controller is designed with 5 analog inputs, 3 analog outputs, 1 triac output, 4 binary inputs, and 6 relay outputs. It also has an on-board BACnet port for connection to an MSTP network. The Controller contains a 2x8 LCD character display and 4 buttons that allow for status and alarm display and force modes as well as BACnet configuration. The VCB-X Controller provides for Constant Volume, VAV, Single Zone VAV, Makeup Air, and Air-Source Heat Pump applications. Most common HVAC unit control applications can be configured using only the VCB-X Controller. If the application requires more inputs and/or outputs, optional expansion modules are available to provide for additional analog, binary, or digital inputs and outputs as required.*



The VCC-X controller is designed with 8 analog inputs, 4 analog outputs, 8 binary inputs, and 8 relay outputs. It also has an on-board BACnet port for connection to an MSTP network. The controller contains a 2x8 LCD character display and 4 buttons that allow for status and alarm display and force modes as well as BACnet configuration. The VCC-X Controller provides for Constant Volume, VAV, Single Zone VAV, Makeup Air, PAC, D-PAC, and Air-Source Heat Pump Applications. Most common HVAC unit control applications can be configured using only the VCC-X Controller. If the application requires more inputs and/or outputs, optional expansion modules are available to provide for additional analog, binary, or digital inputs and outputs required.

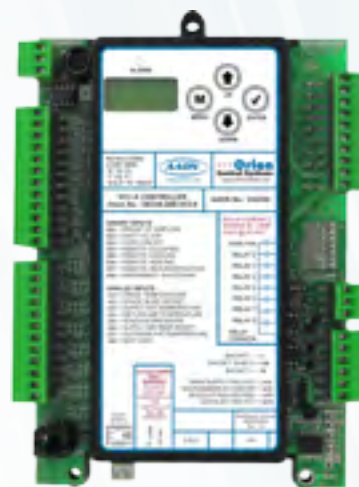

**FREE!!!** WattMaster Prism II software offers a Windows based graphical interface for user interaction with for the building's HVAC system. It provides enhanced, easy to understand status screens for each type of WattMaster system installed. Prism II software has provisions for custom screens which allow floor plans, equipment photos or user defined summary screens to be implemented by the user to meet their own individual needs. All controlling setpoints, trend logs and alarm conditions are accessed in the Prism II environment. Prism II can be configured for a direct on-site installation, a remote modem connection, or a TCP/IP internet connection to several installations.







THE **MICRO CONTROL SYSTEMS (MCS) MAGNUM CONTROLLER** IS FACTORY INSTALLED ON ALL CHILLER AND OUTDOOR MECHANICAL ROOM EQUIPMENT AND IS ALSO AVAILABLE IN A ROOFTOP UNIT CONFIGURATION FOR LARGE COMMERCIAL ROOFTOP UNITS. THE CHILLER CONTROLLER AUTOMATICALLY CYCLES COMPRESSORS TO MAINTAIN LEAVING WATER SETPOINT TEMPERATURE OVER A WIDE VARIETY OF OPERATING CONDITIONS. THE MAGNUM RTU CONTROLLER PROVIDES FOR CONSTANT VOLUME, VAV, SINGLE ZONE VAV, AND MAKEUP AIR APPLICATIONS. THE LCD DISPLAY PROVIDES LOCAL SYSTEM INFORMATION FOR SCHEDULED SERVICE AND MAINTENANCE. CONNECTIONS ON THE MCS CONTROLLER ALLOW BUILDING MANAGEMENT SYSTEMS INTERACTIVE COMMUNICATION OR MONITORING OF THE UNIT.



### MCS Magnum Controller Advantages

- Controller can be directly monitored by Modbus® protocol with up to 115,200 baud through the RS-485 Comm Port.
- Controller can be directly monitored by BACnet® and Modbus® IP through a 10 Mbps Ethernet.
- Controller can be communicated via LonTalk® or BACnet® MSTP protocols through a factory installed external adapter.
- Interactive communication with the controller can be done through MCS protocol through either the RS-485 Comm Port or Ethernet connection.
- Standard chiller sensors monitor entering water temperature, leaving water temperature, and evaporator flow. Sensors also monitor each refrigerant circuit's suction temperature and pressure.
- Optional diagnostic sensors provide each refrigerant circuit's discharge temperature and pressure. Optional diagnostic sensors also monitor each compressor's current.
- Optional 56K modem allows remote communication to the unit from MCS, AAON, or the customer to assist with service, diagnosis, and program updates.





THE **MICRO CONTROL SYSTEMS (MCS) MICROMAG CONTROLLER** IS AVAILABLE FOR LIGHT COMMERCIAL ROOFTOP UNIT OR SPLIT SYSTEMS WITH ONE OR TWO SCROLL COMPRESSORS. THE CONTROLLER ALLOWS USERS TO TAKE FULL ADVANTAGE OF AAON EXCLUSIVE FEATURES AND PROVIDES FOR CONSTANT VOLUME, VAV, SINGLE ZONE VAV, AND MAKEUP AIR APPLICATIONS.

### MCS MicroMag Controller Advantages

- The LCD display and user interface provides local system information for scheduled service and maintenance.
- Only simple field configuration is needed to start up equipment. Controller requires no additional programming because all control applications and operational features are factory embedded.
- Interactive communication with the controller can be done through MCS protocol through either the RS-485 Comm Port or Ethernet connection.
- Free MCS Connect software is available to download on a PC and connect to and configure the controller
- BACnet IP and Modbus IP connections on the controller allow building management systems interactive communication or monitoring of the unit.
- Controller can be communicated via LonTalk® or BACnet® MSTP protocols through a factory installed external adapter.





THE **AAON JENESYS CONTROLLER**, POWERED BY NIAGARA<sup>AX</sup> FRAMEWORK<sup>TM</sup>, IS AN INTERNET BASED STAND-ALONE CONTROLLER DEVELOPED FOR NETWORK APPLICATIONS. THE CONTROLLER IS IP ADDRESSABLE, CAN RESIDE ON A TCP/IP NETWORK AND CAN HAVE ALL UNIT AND SYSTEM FUNCTIONS CONTROLLED WITH AN INTERNET BROWSER IN REAL-TIME; INCLUDING SETPOINT ADJUSTMENT, SCHEDULING, ALARMING, TRENDING, LOGGING, AND DIAGNOSTICS. CONTACT AAON APPLICATIONS DEPARTMENT FOR MORE INFORMATION.

### AAON JENEsys Controller Advantages

- Controller can be directly integrated into LonWorks®, BACnet®, Modbus®, and other widely-used building automation systems. No external devices are needed for integration.
- Connections included on controller include two RJ-45 Ethernet ports, one RS-232 port and one RS-485 port.
- XML security functions cover platform, administration and user access.
- Scalability of the control provides solutions from the smallest to largest AAON equipment and incorporates a future-proof strategy that evolves as building automation strategies change. Up to one 34 I/O point and two 16 I/O point expansion modules are available to manage additional features and options. Individual sensor options and unit control options are also scalable with extra sensors available to be added to any control package.
- Control capabilities include among others: Variable air volume, constant volume, makeup air, advanced dehumidification strategies, heat pump heating, building pressure control, indoor air quality control (CO2), and modulating DX cooling.

Powered by **niagara** FRAMEWORK<sup>TM</sup>

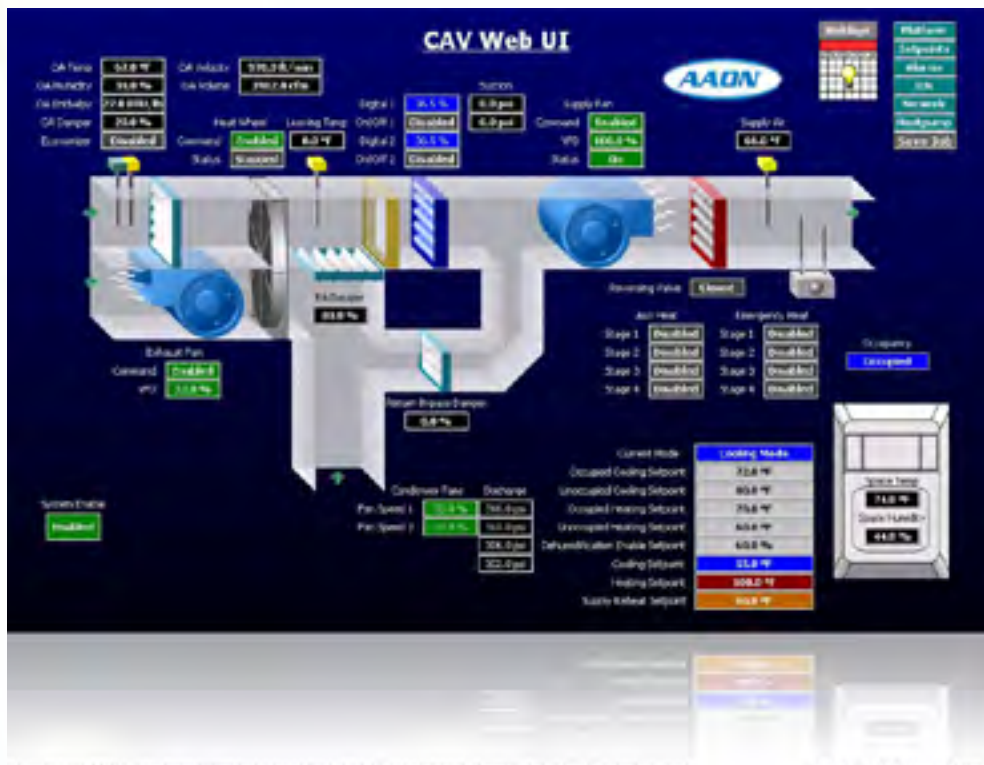

**TERMINAL BLOCK OR CUSTOMER INSTALLED CONTROLS** IS A LOW VOLTAGE TERMINAL BLOCK WITH LABELED CONNECTIONS PROVIDED FOR FIELD CONNECTION TO A THERMOSTAT OR A FIELD PROVIDED AND INSTALLED CONTROL SYSTEM. FACTORY INSTALLED ISOLATION RELAYS CAN BE PROVIDED TO PREVENT A VOLTAGE DROP IN THE CONTROL CIRCUIT.

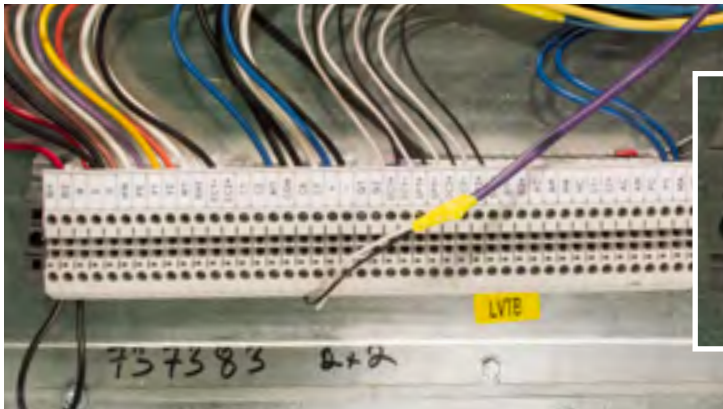

◀ Low Voltage Terminal Block

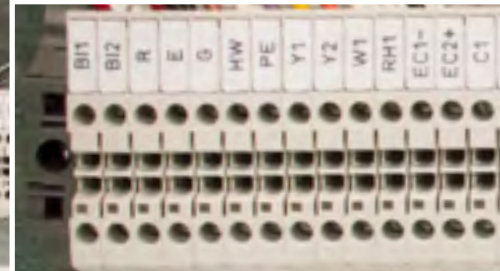

▲ Unit Specific Terminals Labels

**FACTORY INSTALLED CUSTOMER PROVIDED CONTROLS** IS A FEATURE AVAILABLE FROM AAON THAT ALLOWS YOU TO SPECIFY THE TYPE AND MANUFACTURER OF THE CONTROLLER TO BE USED IN YOUR AAON EQUIPMENT. THE AAON SALES REPRESENTATIVE AND AAON APPLICATIONS PERSONNEL WILL REVIEW YOUR SPECIFIC CONTROL REQUIREMENTS TO VERIFY THAT THE CONTROLLER SELECTED IS CAPABLE OF PROVIDING ALL INPUTS AND OUTPUTS REQUIRED TO OPERATE AAON EQUIPMENT. BY UNDERSTANDING THE APPLICATION AND THE CONTROLLER SELECTED FOR USE, THE AAON ENGINEERING DEPARTMENT CAN VERIFY IF THE CONTROLLER IS ABLE TO PHYSICALLY FIT IN THE CONTROL CABINET ALONG WITH THE OTHER REQUIRED FACTORY INSTALLED COMPONENTS. AAON WILL THEN INTEGRATE THIS CONTROLLER INTO THE EQUIPMENT AND CREATE A CUSTOM WIRING DIAGRAM SPECIFICALLY FOR YOUR UNIT.

THIS OPTION ALLOWS COMPLETE FLEXIBILITY IN CONTROLS USED ON THE JOB AND PREVENTS JOBS FROM BEING LOCKED INTO PROPRIETARY CONTROLLERS OR MANUFACTURER SPECIFIC CONTROL STRATEGIES. FACTORY INSTALLED CUSTOMER PROVIDED CONTROLS SAVES TIME AND MONEY AT THE JOB SITE BY ALLOWING AAON EXPERT TECHNICIANS WHO HAVE KNOWLEDGE OF AAON EQUIPMENT TO INSTALL AND WIRE THE CONTROLS AT THE FACTORY.

Factory Installed Customer Provided Controls ▶







## AAON FACTORY PROVIDED CONTROL SOLUTIONS

### Unitary Systems, Split Systems, and Air Handling Units

	AAON Touchscreen Controller	WattMaster VCB-X	WattMaster VCM-X	WattMaster VCC-X
Unit Capacity Control	2-30 tons (1 or 2 compressor systems)	2-30 tons (1 or 2 compressor systems)	2-230 tons	2-140 tons
Variable Capacity Compressor Control	✓	✓	✓	✓
Constant Volume Applications	✓	✓	✓	✓
Variable Air Volume (VAV) Applications	✓	✓	✓	✓
Single Zone VAV Applications	✓	✓	✓	✓
Makeup Air Applications	✓	✓	✓	✓
Dehumidification	✓	✓	✓	✓
Heat Pump	✓	✓	✓	✓
User Interface	Space Mounted Touchscreen Controller	Handheld Service Tool, System Manager, Touchscreen System Manager, or PC with free Prism II Software	Handheld Service Tool, System Manager, Touchscreen System Manager, or PC with free Prism II Software	Handheld Service Tool, System Manager, Touchscreen System Manager, or PC with free Prism II Software
Networking	Built-in BACnet MSTP and Modbus RTU	Built-in BACnet MSTP, LonWorks, and N2 available via PT-Link II	BACnet MSTP, LonWorks, and N2 available via PT-Link II	Built-in BACnet MSTP, LonWorks, and N2 available via PT-Link II

### Chillers and Outdoor Mechanical Rooms

	MCS Magnum
Unit Capacity Control	5-540 tons
Variable Capacity Compressor Control	✓
Chiller and Pumping Package	✓
Boiler and Pumping Package	✓
Fluid Cooling and Pumping Package	✓
Constant or Variable Flow	✓
User Interface	LCD User Interface Panel, Touchscreen Computer System, or PC with free MCS Connect Software
Networking	Built-in BACnet IP and Modbus IP. LonTalk and BACnet MSTP available via adapter



### Unitary Systems, Split Systems, and Air Handling Units

AAON JENEsys	MCS MicroMag	MCS Magnum RTU	
2-230 tons	2-30 tons (1 or 2 compressor systems)	45-240 tons	<b>Unit Capacity Control</b>
✓	✓	✓	<b>Variable Capacity Compressor Control</b>
✓	✓	✓	<b>Constant Volume Applications</b>
✓	✓	✓	<b>Variable Air Volume (VAV) Applications</b>
✓	✓	✓	<b>Single Zone VAV Applications</b>
✓	✓	✓	<b>Makeup Air Applications</b>
✓	✓	✓	<b>Dehumidification</b>
✓	✓	✓	<b>Heat Pump</b>
PC via Web Browser or LCD User Interface Panel	LCD User Interface Panel, Touchscreen System, or PC with free MCS Connect Software	LCD User Interface Panel, Touchscreen System, or PC with free MCS Connect Software	<b>User Interface</b>
Built-in BACnet MSTP/IP, LonWorks, Fox, and Modbus RTU/TCP	Built-in BACnet MSTP and Modbus RTU. LonTalk and BACnet IP available via adapter	Built-in BACnet IP and Modbus IP. LonTalk and BACnet MSTP available via adapter	<b>Networking</b>

# AAON QUICK SELECTION

**Airflow (cfm)**

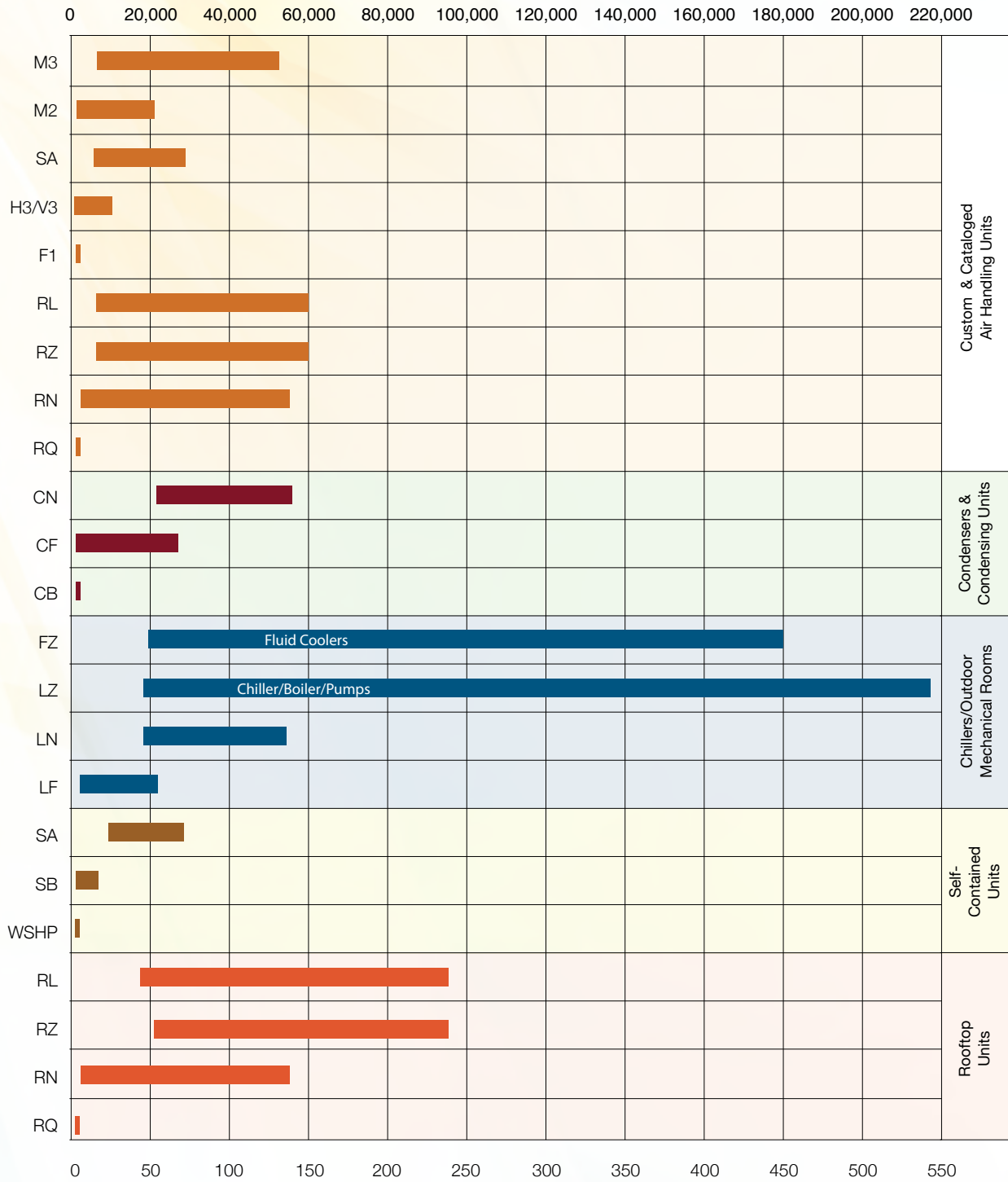

**Nominal Cooling (tons)**



**Don't see the specific product you need?** AAON can meet your requirements with Custom Equipment designed specifically for your exact application and job specifications. Visit [www.aaon.com/repsearch](http://www.aaon.com/repsearch) or call 918.583.2266 to locate a representative near you.

# HEATING & COOLING COILS



FOR OVER 25 YEARS, AAON HAS SUPPLIED THE COIL NEEDS OF INDUSTRIAL AND COMMERCIAL HVAC CUSTOMERS. TODAY, AAON OFFERS A WIDE SELECTION OF CHILLED WATER, HOT WATER, STEAM, AND REFRIGERANT FIN AND TUBE COIL CONFIGURATIONS. AAON COILS CAN BE EASILY CONFIGURED WITH THE AAON ECAT SELECTION SOFTWARE FROM AN EXPANSIVE LIST OF FEATURES TO MEET YOUR COIL CONSTRUCTION AND PERFORMANCE SPECIFICATIONS. ALL AAON COILS FOLLOW A RIGOROUS MANUFACTURING PROCESS AND TESTING ROUTINE TO ENSURE THEY ARE FREE FROM DEFECTS BEFORE SHIPMENT.

### Booster Coils

Booster Coils configurations are available that are sure to meet your exact needs for supplemental heating. The coil options include tube diameter, rows deep, finned height and length, fin thickness, fin material, fins per inch, tube wall, connection size and type, and casing configuration. Using the AAON ECat selection software, the critical criteria can be selected to ensure that the right AAON booster coil is selected to provide optimum performance in any application.



### Heating Coils

Whether a job calls for steam distributing heat or hot water heat, AAON heating coils are designed to fit any application. All AAON heating coils are available with multiple tubing diameter options, a variety of tube wall thicknesses, and multiple rows deep. Hot water heating coils can be circuited in a full, half, quarter, double, or 1½ serpentine circuiting to optimize heating performance. Steam coils are configured as tube-in-tube distributing to maximize performance at low entering air temperature conditions. Since AAON hot water coils are rated for entering water temperatures as high as 200°F and steam distributing coils rated for entering superheated steam as high as 25 psig, AAON heating coils can satisfy the rigorous demands of the HVAC marketplace.



### DX Evaporator or Condenser Coils

For any system requiring direct expansion refrigerant coils, AAON can provide the evaporator or condenser coil to match the exact need. DX evaporator coils are available with multiple rows, multiple fins per inch options, and can be configured with interlaced or face split circuitry for capacity modulation and capitalize on valuable energy savings. DX condenser coils are available with multiple rows, up to 24 fins per inch, and can be configured with interlaced or face split circuitry. All DX evaporator coils and heat pump condenser coils include rifled tube enhancements and refrigerant distributors that ensure proper refrigerant distribution into the coil. AAON DX coils are designed to maximize performance no matter the specific job requirements.

Fins available in either aluminum or copper with a number of different thicknesses to fit the specific application

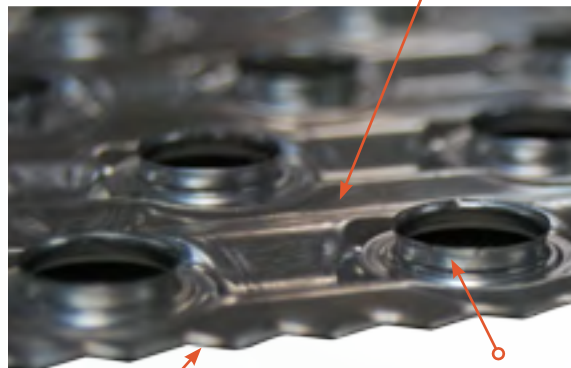

All fins have sine wave enhancements for greater heat transfer efficiency

Drawn fin collars increase heat transfer and offer precise fin densities



## Chilled Water Cooling Coils

AAON offers an array of options to satisfy hydronic cooling coil requirements whether the application calls for chilled water only or a glycol solution for freeze protection. With multiple tubing diameter options, coil circuitry options and fin densities, and up to 12 rows deep for additional latent capacity for dehumidification applications, AAON cooling coils can maximize performance

regardless of the job specification. Designed to save installation and maintenance time and money, all hydronic coils include factory installed manifolds designed to handle a wide range of water flow rates. World class leak testing equipment and manufacturing processes, and AHRI 410 certification, ensure AAON hydronic coils are the best.



AAON chilled water and hot water coils are certified in accordance with AHRI Standard 410, Forced Circulation Air-Cooling and Air-Heating Coils. The AHRI Certification program is administered and governed by AHRI, which ensures that various types of heating, ventilation, air conditioning, refrigeration, and water heating products perform according to manufacturers' published claims. Products that are certified through the AHRI Certification Program are continuously tested by an independent third-party laboratory, contracted by AHRI, to determine the product's ability to conform to one or more product rating standards or specifications. Specifying AHRI Certified AAON Coils instills confidence in coil performance.

# Booster Coil Details



Booster Coils										
Type	Tube Material	Fin Material	Casing Material	Casing Type	Rows	FPI	Circuitry	Tube Diameter (OD)	Connection Type	Optional Corrosion Protection
Hot Water or Steam	Copper	Aluminum or Copper	G90 Galvanized, Aluminum, or 304 Stainless Steel	U-Flange, Slip and Drive or None	Up to 2	Up to 16	Quarter to Double Serpentine, or Steam Distributing	1/2" or 5/8"	Sweat, MPT, or FPT*	Polymer E-Coating

\* MPT (Male Pipe Thread) and FPT (Female Pipe Thread)

# Hydronic Coil Details

Fin densities from 8 to 16 fins per inch to optimize performance and air side pressure drop

Standard coils are completely encased for structural integrity but can be manufactured without casing for a specific application.

Up to 12 rows circuited to optimize coil performance and water side pressure drop

Manifolds designed to minimize water side pressure drop for a range of flow rates.

Coil inlet and outlet available with either sweat (as shown) or threaded connections (MPT or FPT)

Manifolds include drain plug, vent plug, and Schrader valves to allow verification of positive pressure and leak free coils

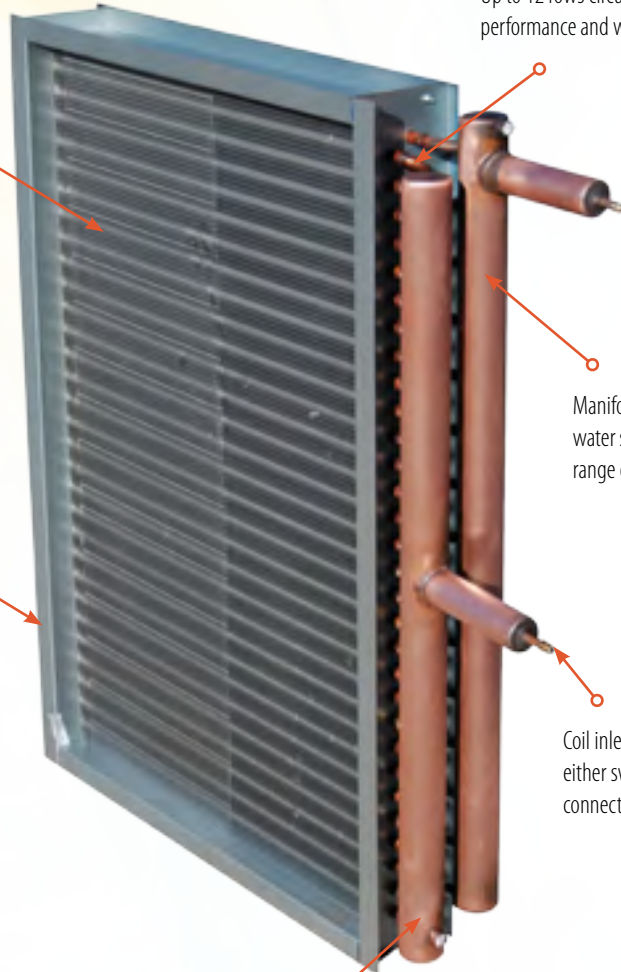

## Hydronic Coils

Type	Tube Material	Fin Material	Casing Material	Casing Type	Rows	FPI	Circuitry	Tube Diameter (OD)	Connection Type	Optional Corrosion Protection
Hot Water Coils	Copper	Aluminum or Copper	G90 Galvanized, Aluminum, or 304 Stainless Steel	U-Flange, Slip and Drive or None	Up to 12	Up to 16	Quarter to Double Serpentine	1/2" or 5/8"	Sweat, MPT, or FPT*	Polymer E-Coating
Steam Coils							Steam Distributing	5/8"		
Chilled Water Coils							Quarter to Double Serpentine	1/2" or 5/8"		

\* MPT (Male Pipe Thread) and FPT (Female Pipe Thread)

# DX Coil Details

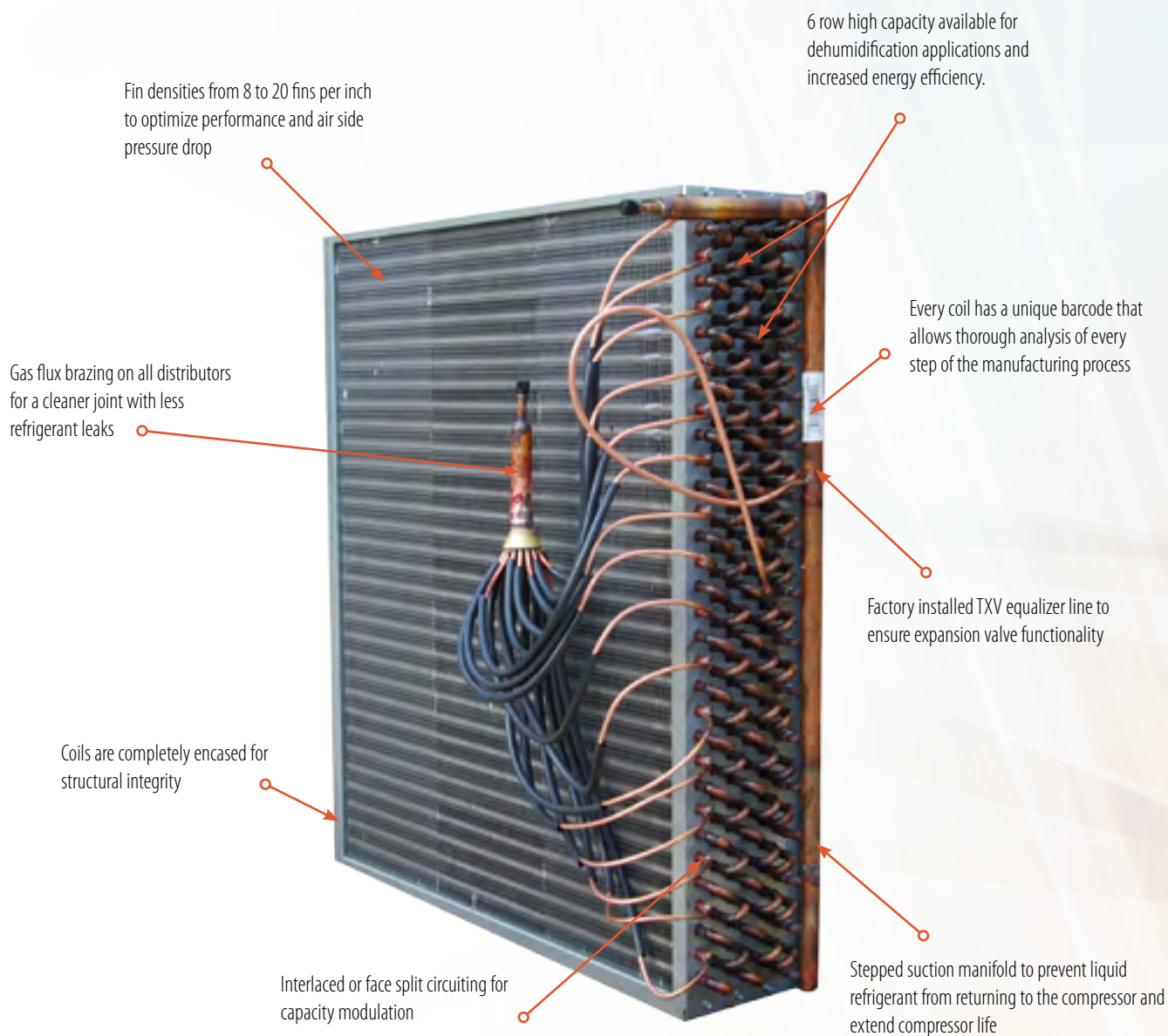

## DX Coils

Type	Tube Material	Fin Material	Casing Material	Casing Type	Rows	FPI	Circuitry	Tube Diameter (OD)	Connection Type	Optional Corrosion Protection
Evaporator Coils	Copper	Aluminum or Copper	G90 Galvanized, Aluminum, or 304 Stainless Steel	U-Flange, Slip and Drive or None	Up to 12	Up to 20	Face Split or Interlaced	3/8" or 1/2"	Sweat, MPT, or FPT*	Polymer E-Coating
Condenser Coils						Up to 24		3/8" or 7mm		

\* MPT (Male Pipe Thread) and FPT (Female Pipe Thread)



Defining Quality. Building Comfort.



SINCE ITS INCEPTION AAON HAS PROVIDED DESIGNS OF THE HIGHEST QUALITY AND PERFORMANCE THAT LEAD THE HVAC INDUSTRY. OUR OBJECTIVE REMAINS THE SAME! PERFORMANCE ORIENTED PRODUCTS THAT PERFORM BEYOND EXPECTATIONS AND PROVIDE LIFE-CYCLE DEPENDABILITY AT A REASONABLE FIRST COST.

It is the intent of AAON to provide accurate and current product information. However, in the interest of product improvement, AAON reserves the right to change pricing, specifications, and/or design of its product without notice, obligation, or liability. Copyright © AAON, all rights reserved throughout the world. AAON and AAONAIRE are registered trademarks of AAON, Inc., Tulsa, OK.